



US00D758792S

(12) **United States Design Patent**  
**Karussi**

(10) **Patent No.:** **US D758,792 S**  
(45) **Date of Patent:** **\*\* Jun. 14, 2016**

(54) **LID FOR HOT BEVERAGE DRINKING VESSELS**

D728,311 S \* 5/2015 Eyal ..... D7/510  
D742,173 S \* 11/2015 Perman ..... D7/507  
2013/0119060 A1 \* 5/2013 Chiou ..... A47G 19/2272  
220/254.3

(71) Applicant: **Tervis Tumbler Company**, North Venice, FL (US)

**OTHER PUBLICATIONS**

(72) Inventor: **Kurt Karussi**, Osprey, FL (US)

“Tervis 16oz. Travel Lid”. Found online Nov. 4, 2015 at tervis.com. Page dated Nov. 29, 2011. Retrieved from <http://web.archive.org/web/20111129111832/http://www.tervis.com/designs/Accessories/Travel-lids/dc0fe00377e0ec722da5bd146541427c>.\*

(73) Assignee: **Tervis Tumbler Company**, North Venice, FL (US)

“Green Bay Packers 16 oz. Tervis Tumbler Lid”. Found online Nov. 4, 2015 at packersproshop.com. Retrieved from <http://www.packersproshop.com/Green-Bay-Packers-Home-And-Office/Kitchen-And-Drinkware/sku-20>.\*

(\*\*) Term: **14 Years**

\* cited by examiner

(21) Appl. No.: **29/520,381**

*Primary Examiner* — Robert M Spear

(22) Filed: **Mar. 13, 2015**

*Assistant Examiner* — Kendra L Hamilton

(51) **LOC (10) Cl.** ..... **07-01**

(74) *Attorney, Agent, or Firm* — Caesar Rivise, PC

(52) **U.S. Cl.**

USPC ..... **D7/392.1; D7/396.2**

(58) **Field of Classification Search**

USPC ..... D7/391, 392, 392.1, 396.2, 397, 509, D7/510, 511, 512, 514, 620; D9/435, 436, D9/440, 441, 442, 447, 451, 503, 504, 516, D9/527, 552, 643, 666, 761; 215/212, 224, 215/329, 386, 387, 388, 392, 396; 220/254.8, 700, 703, 705, 710.5, 711, 220/715

CPC ..... A47G 19/2272

See application file for complete search history.

(57) **CLAIM**

The ornamental design for a lid for hot beverage drinking vessels, as shown and described.

**DESCRIPTION**

FIG. 1 is an isometric view of the lid for a hot beverage drinking vessel of the design;  
FIG. 2 is rear elevation view of the lid for a hot beverage drinking vessel shown in FIG. 1;  
FIG. 3 is front elevation view of the lid for a hot beverage drinking vessel shown in FIG. 1;  
FIG. 4 is right side elevation view of the lid for a hot beverage drinking vessel shown in FIG. 1;  
FIG. 5 is left side elevation view of the lid for a hot beverage drinking vessel shown in FIG. 1;  
FIG. 6 is a top plan view of the lid for a hot beverage drinking vessel shown in FIG. 1; and,  
FIG. 7 is a bottom plan view of the lid for a hot beverage drinking vessel shown in FIG. 1.  
The broken lines designated by the evenly spaced dashes are directed to unclaimed portions and form no part of the claimed design.

(56) **References Cited**

**U.S. PATENT DOCUMENTS**

D312,785 S \* 12/1990 Tucker ..... D9/435  
D441,288 S \* 5/2001 Pillers ..... D7/392.1  
D490,272 S \* 5/2004 Rohe ..... D7/510  
D510,678 S \* 10/2005 Krasne ..... D7/376  
D533,402 S \* 12/2006 Bin ..... D7/510  
D536,213 S \* 2/2007 Schuler ..... D7/392.1  
D543,782 S \* 6/2007 Elkhatib ..... D7/510  
D676,278 S \* 2/2013 Wong ..... D7/510  
D676,280 S \* 2/2013 Wong ..... D7/510  
D677,122 S \* 3/2013 Liu ..... D7/510

**1 Claim, 6 Drawing Sheets**

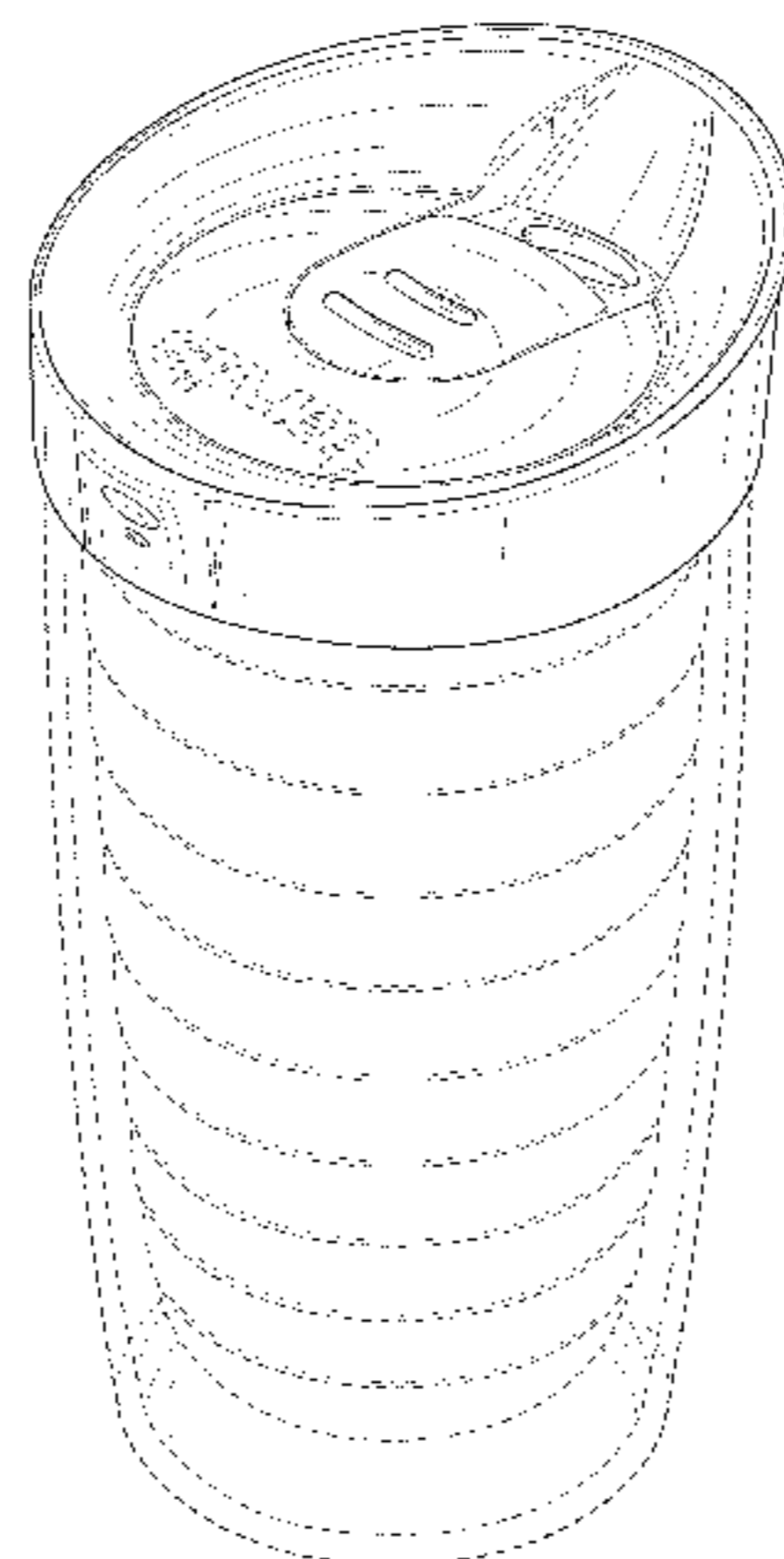

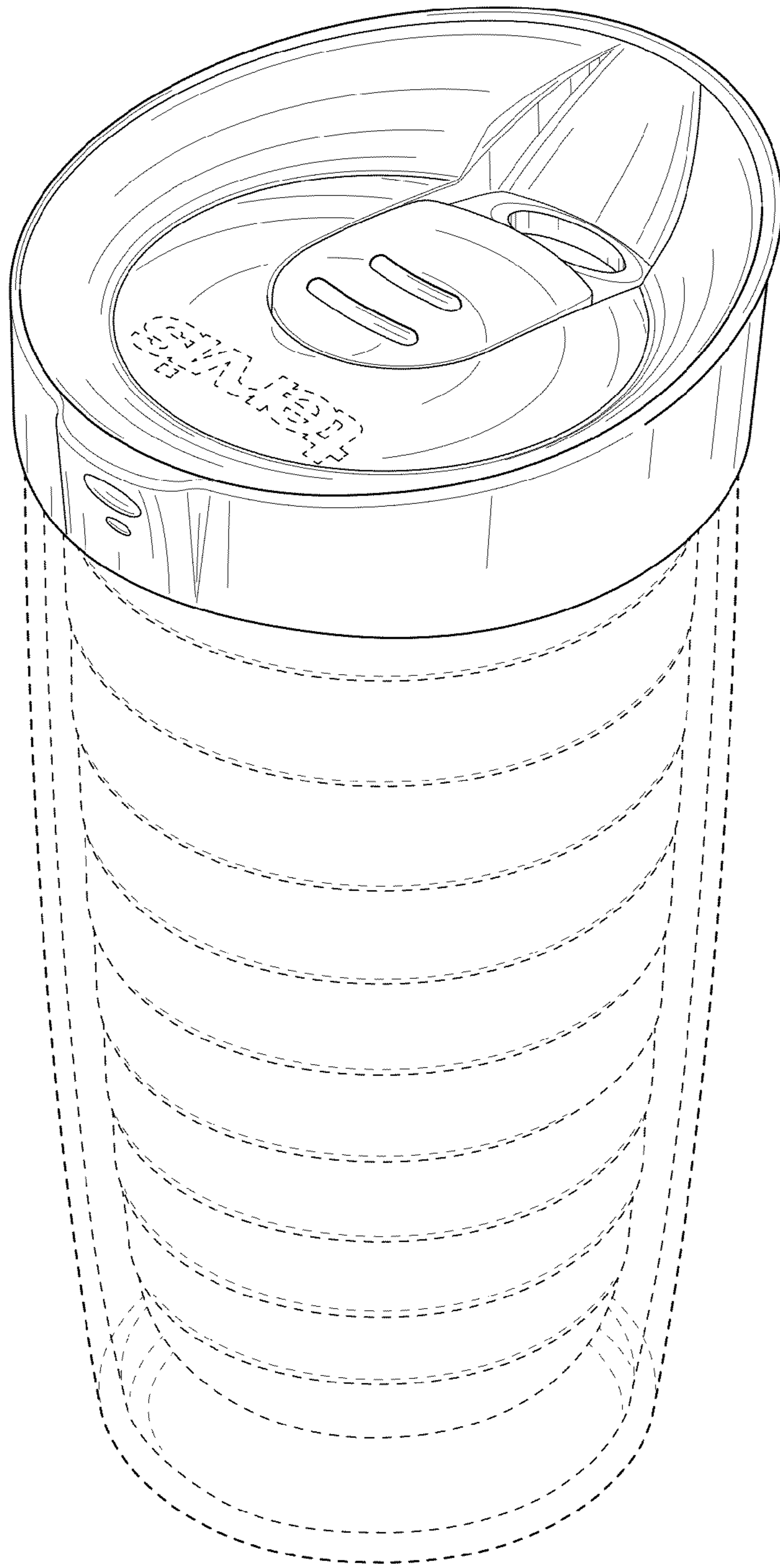

FIG. 1

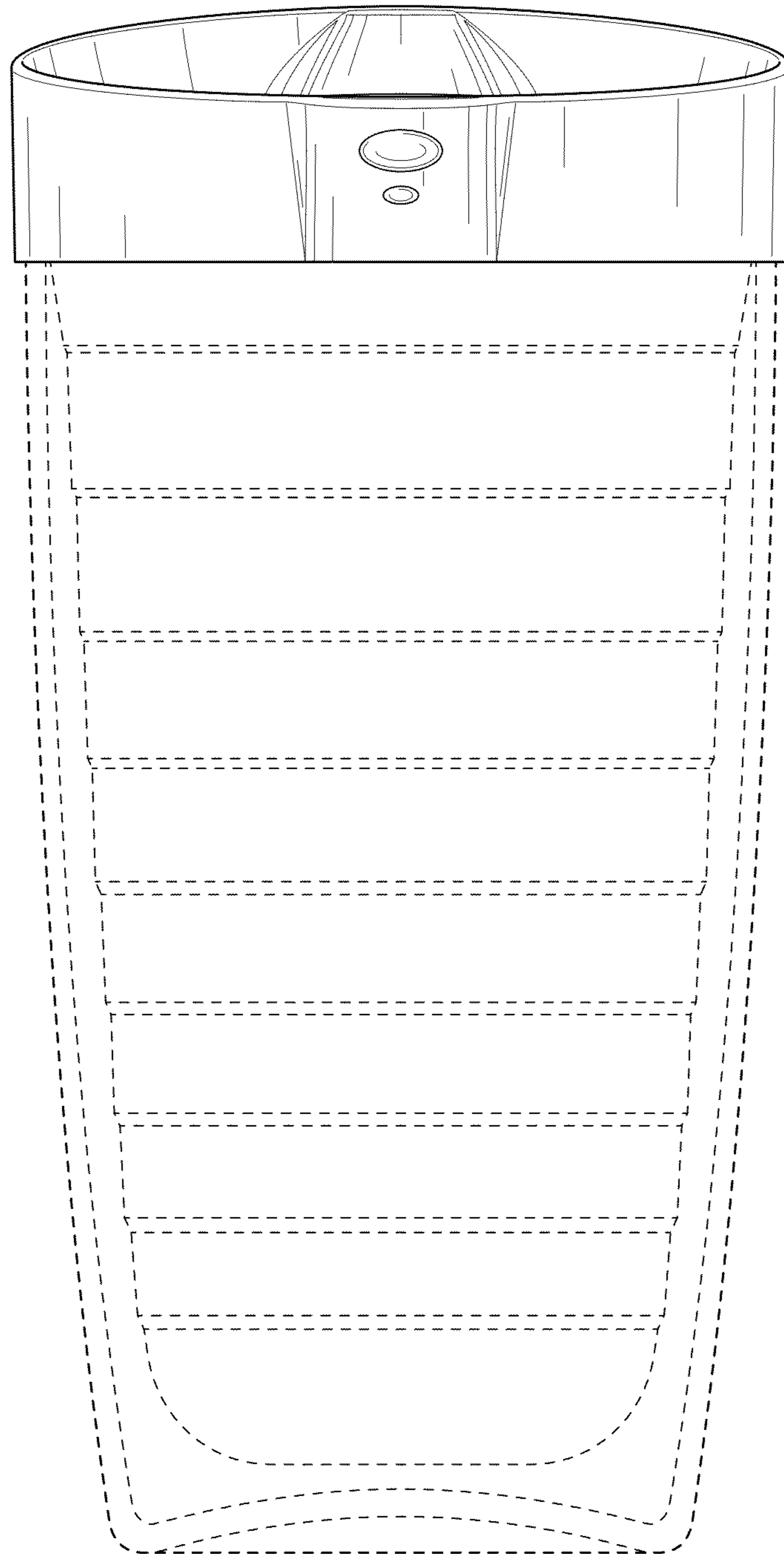

FIG. 2

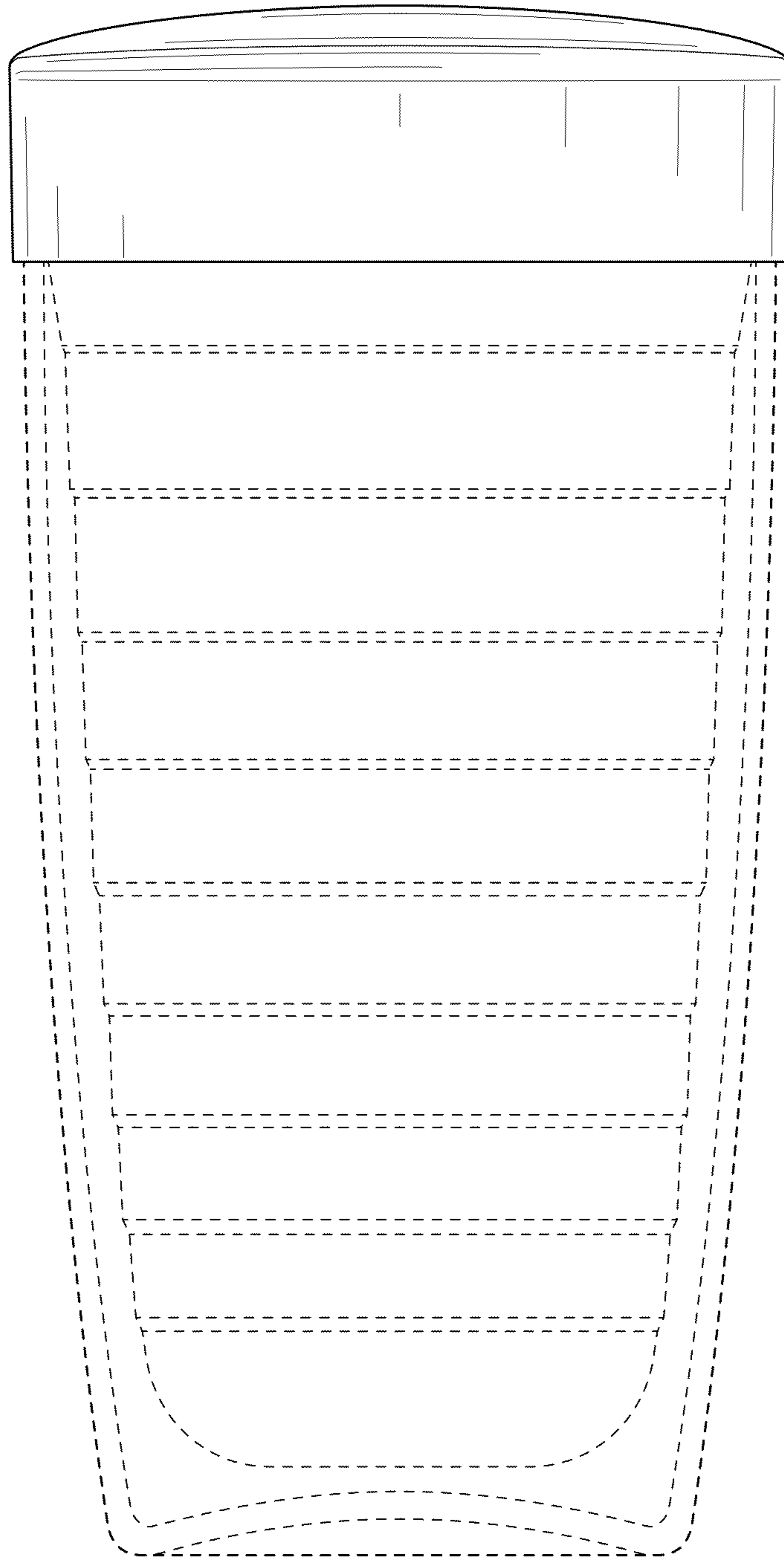

FIG. 3

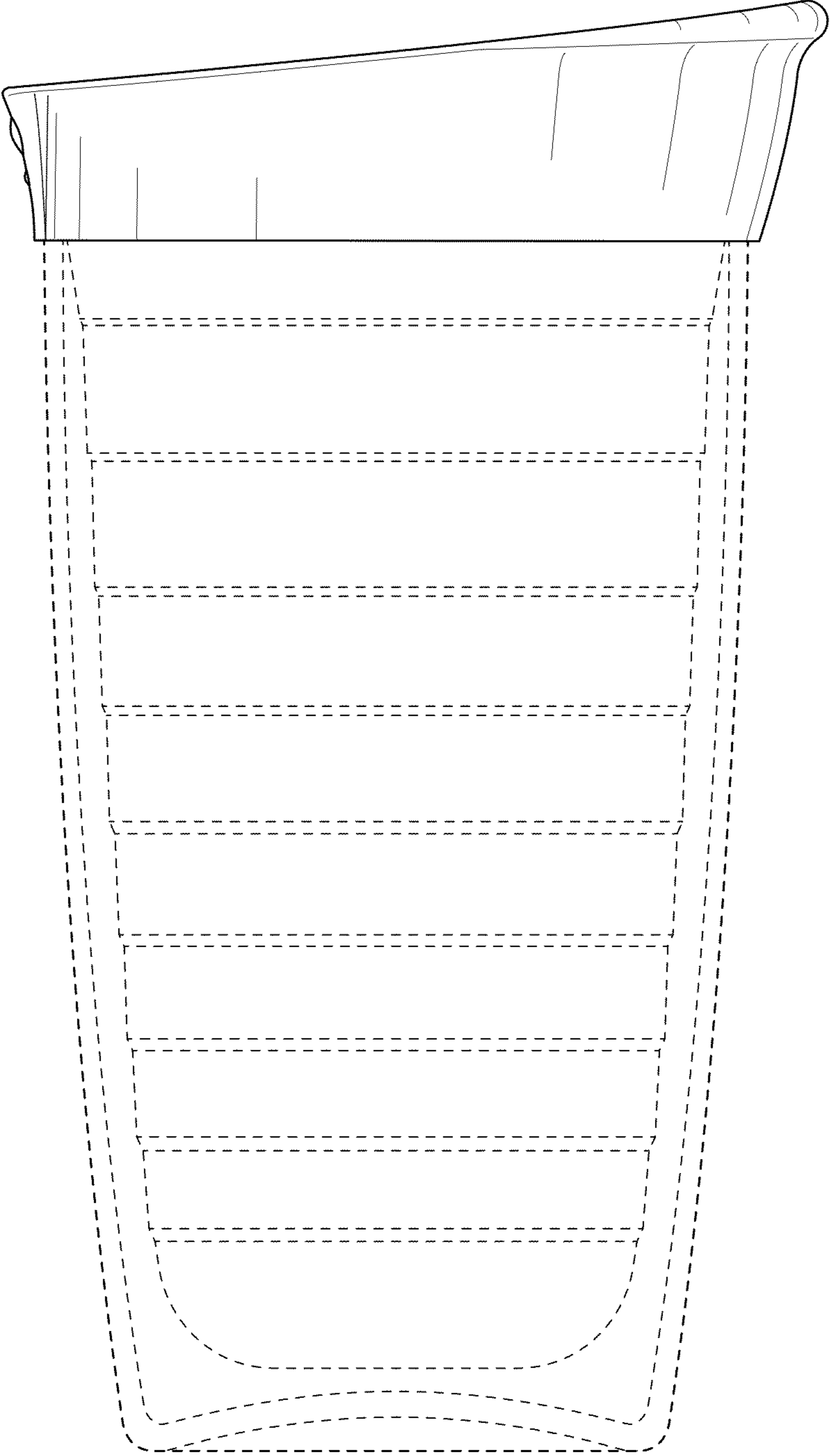

FIG. 4



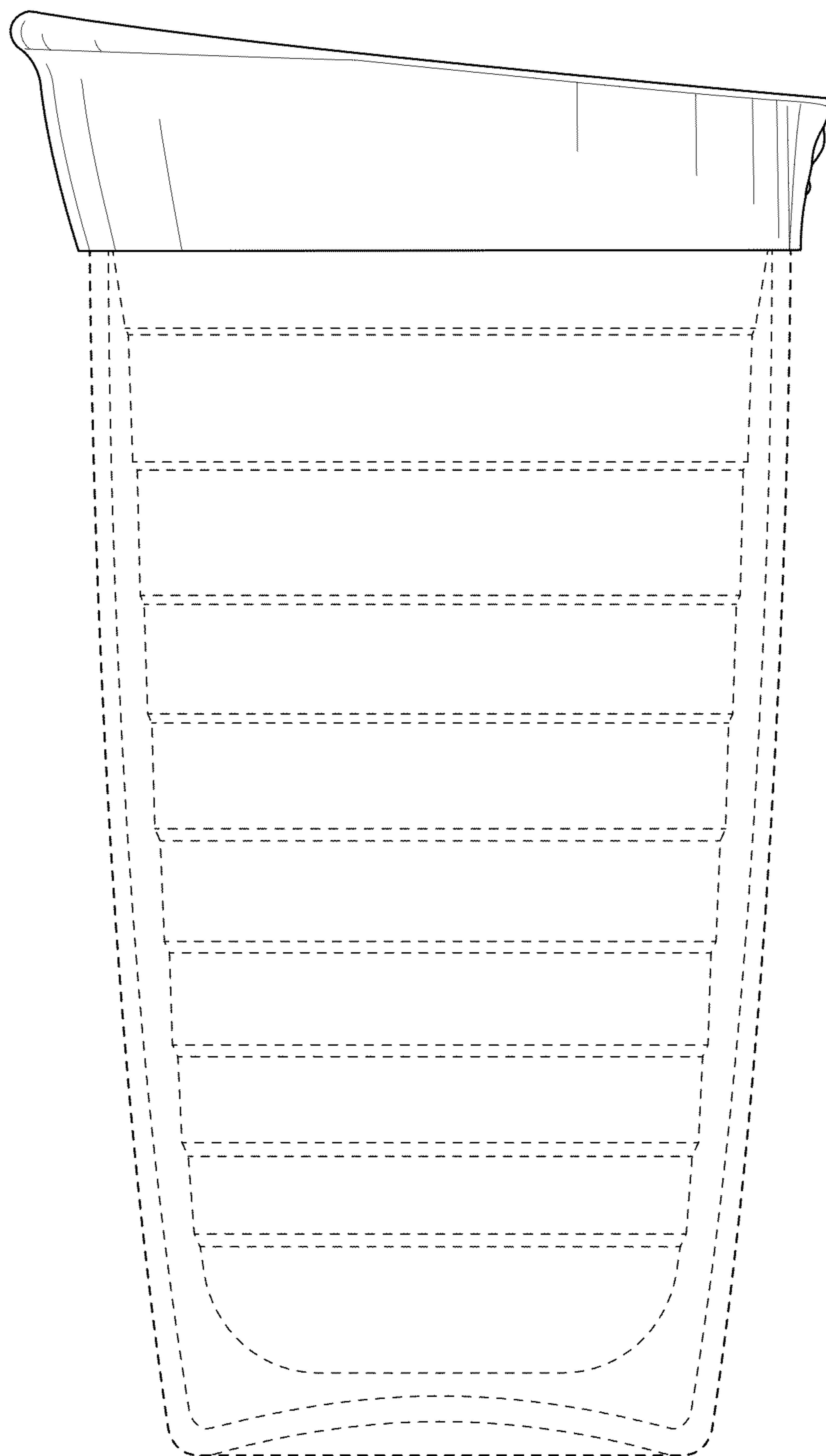

FIG. 5

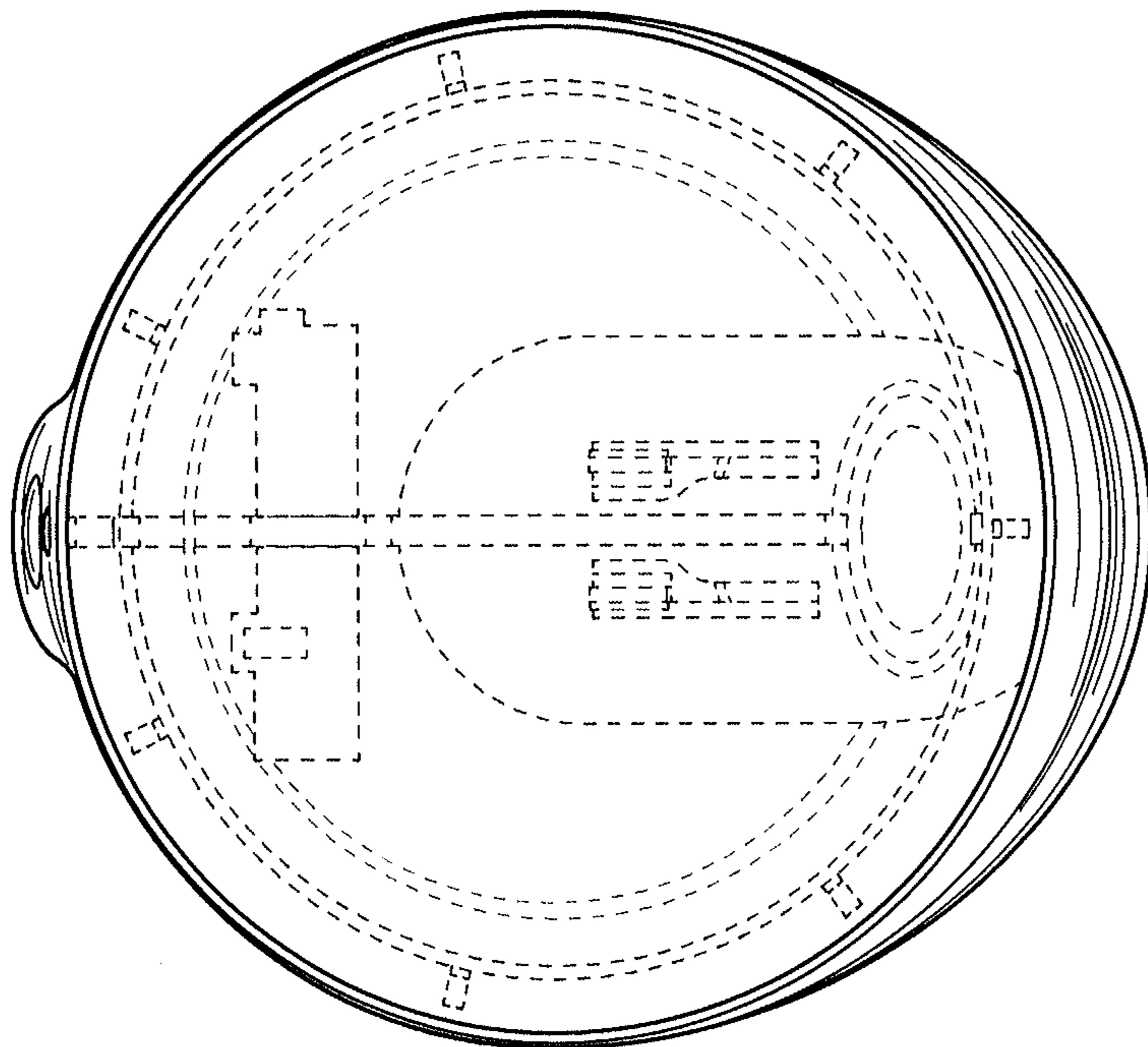

FIG. 7

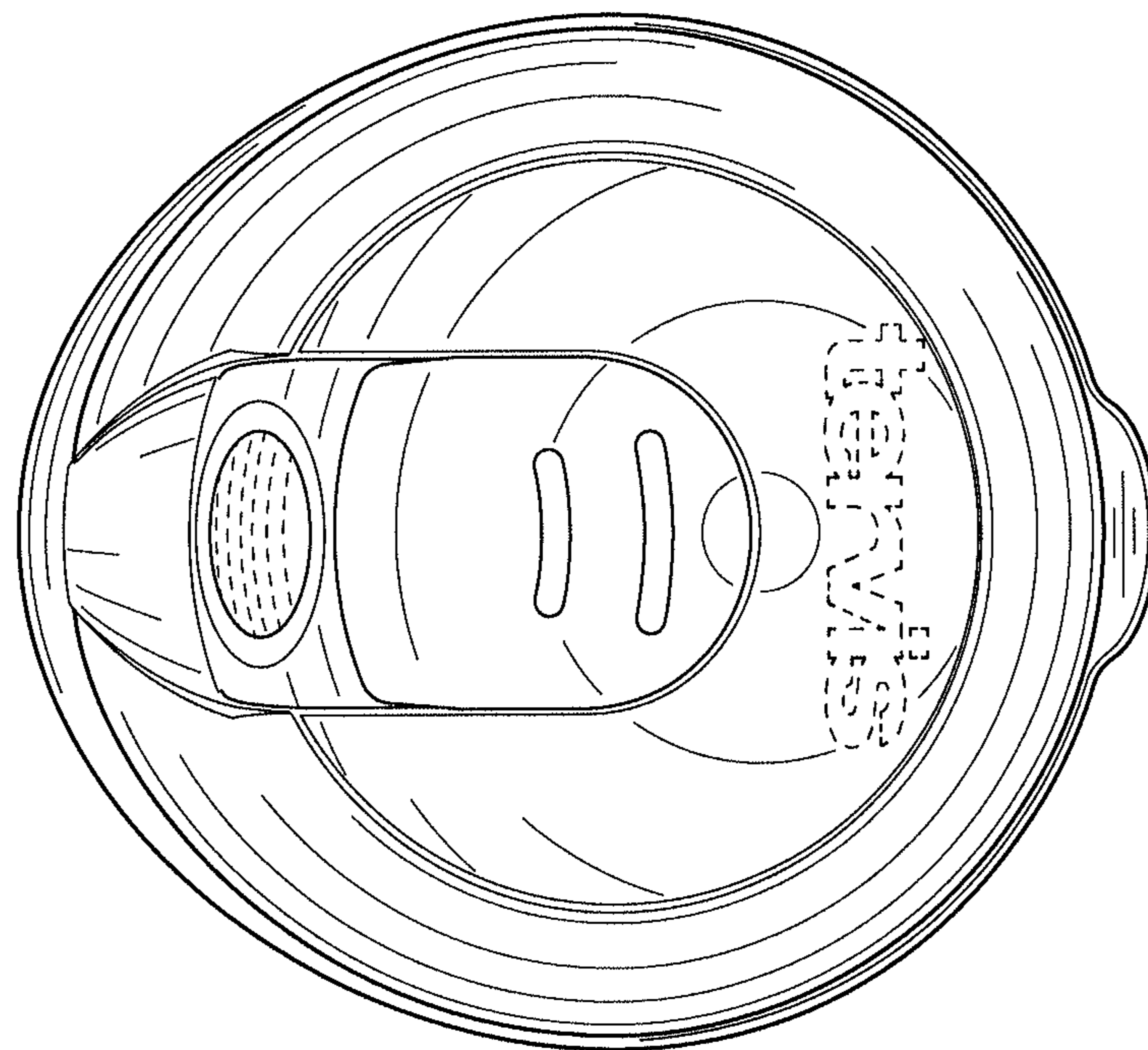

FIG. 6