



US00D758783S

(12) **United States Design Patent**
Lee et al.

(10) **Patent No.:** **US D758,783 S**
(45) **Date of Patent:** **** Jun. 14, 2016**

(54) **TOP BOARD FOR AN ELECTRIC RANGE**

(56) **References Cited**

(71) Applicant: **Samsung Electronics Co., Ltd.**,
Suwon-si (KR)
(72) Inventors: **Ji Hyeoung Lee**, Seoul (KR); **Joonseok Kang**, Suwon-si (KR); **Simon Ireland**,
Bristol (GB); **Young-Seok Lee**, Seoul
(KR)

U.S. PATENT DOCUMENTS

D219,935	S	*	2/1971	Kurer et al.	D7/587
D261,849	S	*	11/1981	Funaki	D7/367
D285,523	S	*	9/1986	Ayukawa	D7/367
D289,130	S	*	4/1987	Rengeji	D7/363
D289,847	S	*	5/1987	Okamoto	D7/363
D326,387	S	*	5/1992	Monitto	D7/346
D387,240	S	*	12/1997	Simmonds	D7/332
6,593,550	B1	*	7/2003	Royer	A47J 36/36 126/24
D501,117	S	*	1/2005	Bassill	D7/367
D643,674	S	*	8/2011	Lee	D7/362
D668,104	S	*	10/2012	Segers	D7/402
D684,808	S	*	6/2013	Mehler	D7/354
D730,680	S	*	6/2015	Palermo	D7/367

(73) Assignee: **Samsung Electronics Co., Ltd.**,
Suwon-si (KR)

(**) Term: **14 Years**

* cited by examiner

(21) Appl. No.: **29/514,339**

Primary Examiner — Ricky Pham

(22) Filed: **Jan. 12, 2015**

(74) *Attorney, Agent, or Firm* — NSIP Law

(30) **Foreign Application Priority Data**

(57) **CLAIM**

We claim the ornamental design for a top board for an electric range, as shown and described.

Jul. 21, 2014 (KR) 30-2014-0035598

DESCRIPTION

(51) **LOC (10) Cl.** **07-02**

FIG. 1 is a front perspective view of a top board for an electric range showing our new design;
FIG. 2 is a front view thereof;
FIG. 3 is a rear view thereof;
FIG. 4 is a left-side view thereof;
FIG. 5 is a right-side view thereof;
FIG. 6 is a top view thereof;
FIG. 7 is a bottom view thereof;
FIG. 8 is an exploded front perspective view thereof; and,
FIG. 9 is a front perspective view thereof showing an example environment.

(52) **U.S. Cl.**

USPC **D7/346**; D7/362; D7/363

(58) **Field of Classification Search**

USPC D7/323, 337, 339, 341, 346, 352,
D7/354–355, 362–367, 409–411

CPC A21B 1/06; A21B 1/50; A21B 1/52;
A47J 36/36; A47J 37/04; A47J 37/06; A47J
37/015; A47J 37/067; A47J 37/0611; A47J
37/0629; A47J 37/0676; F24C 7/06; F24C
7/083; F24C 15/02; F24C 15/166; H05B 3/20;
H05B 3/40

See application file for complete search history.

1 Claim, 7 Drawing Sheets

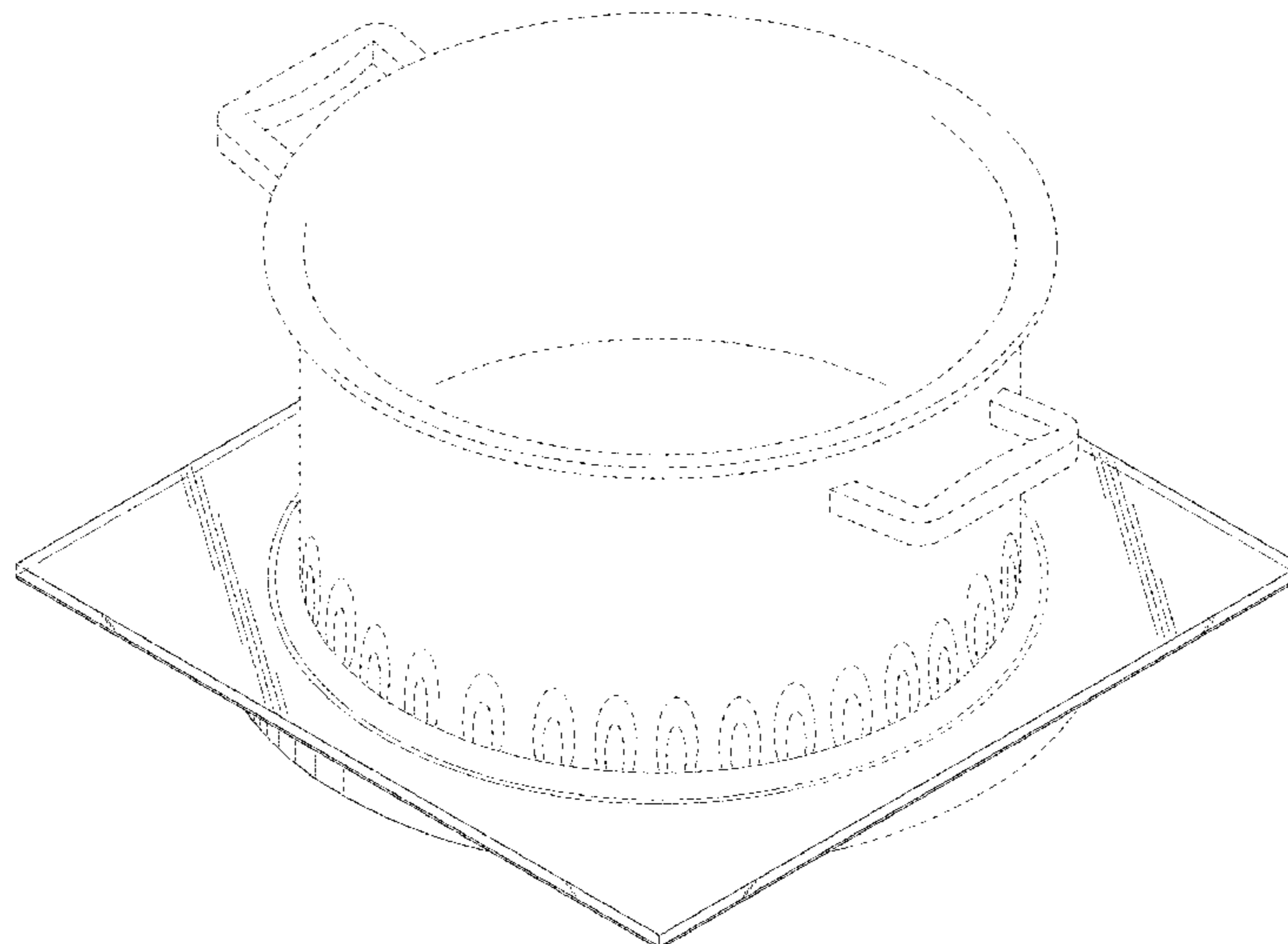

FIG. 1

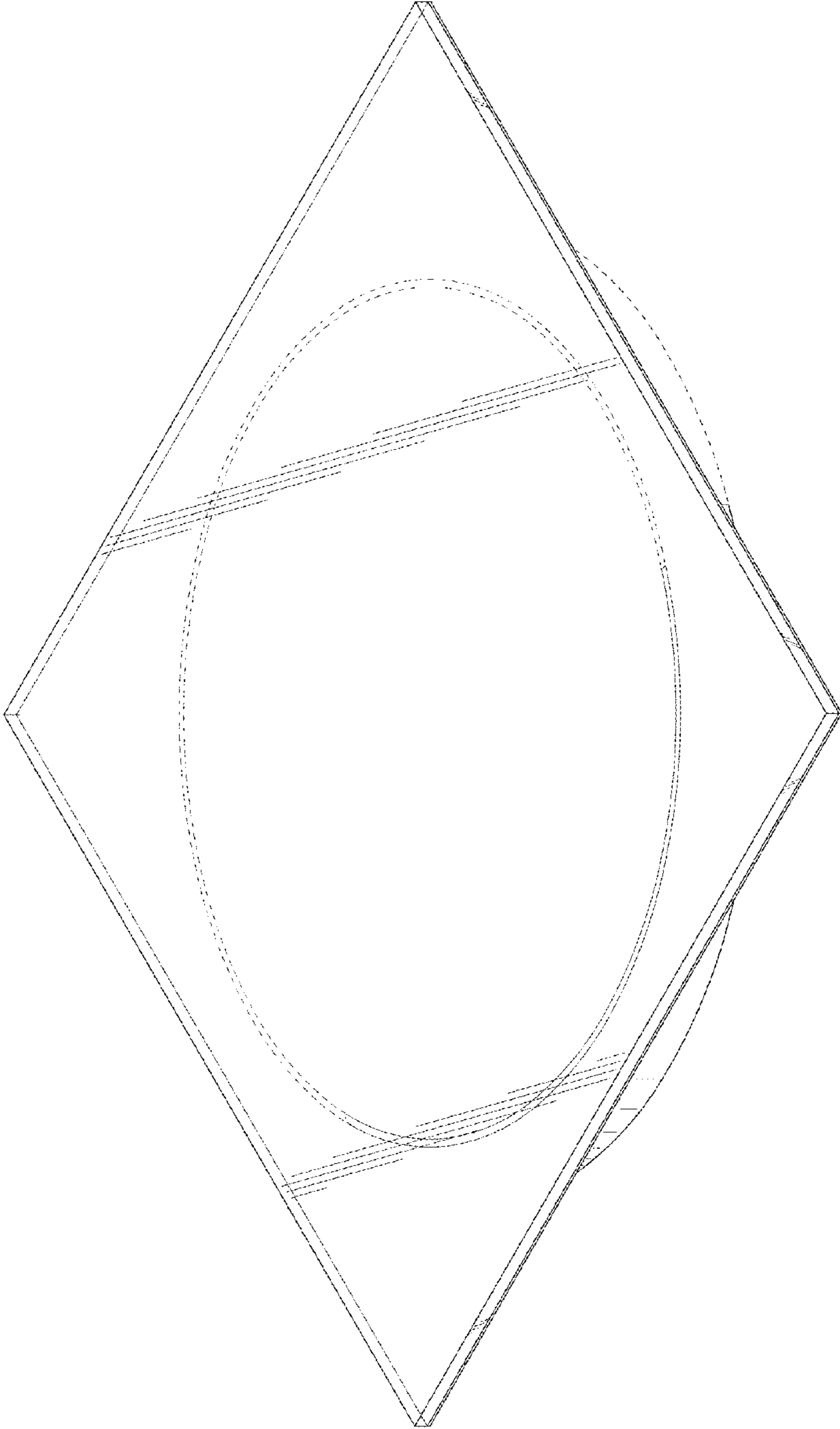

FIG. 2

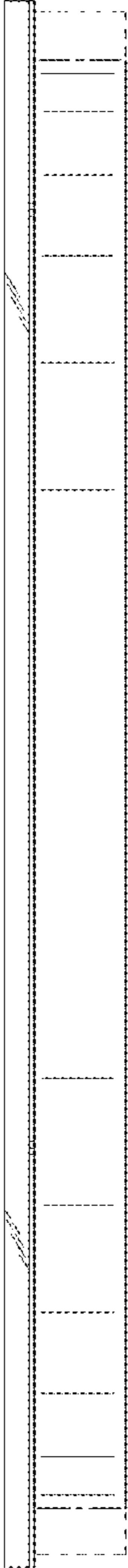

FIG. 3

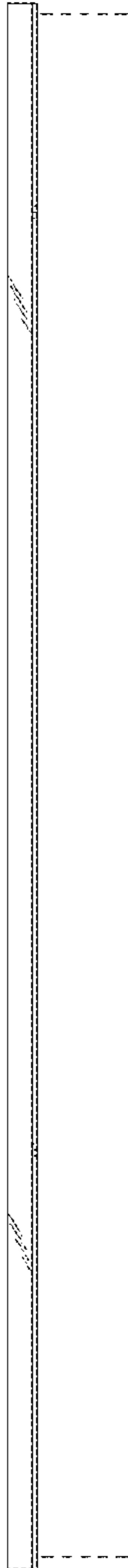

FIG. 4

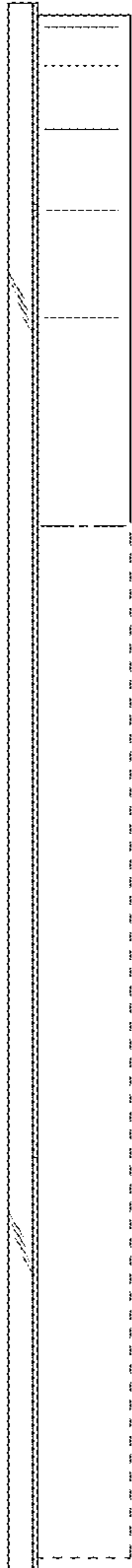

FIG. 5

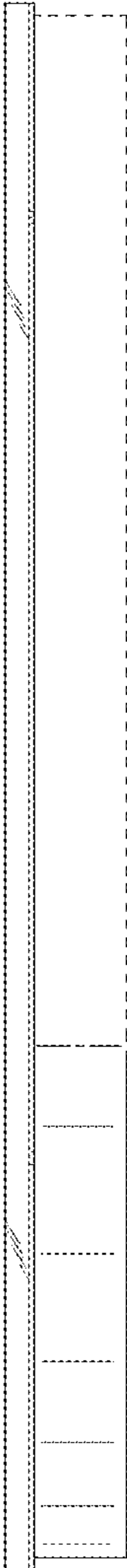

FIG. 6

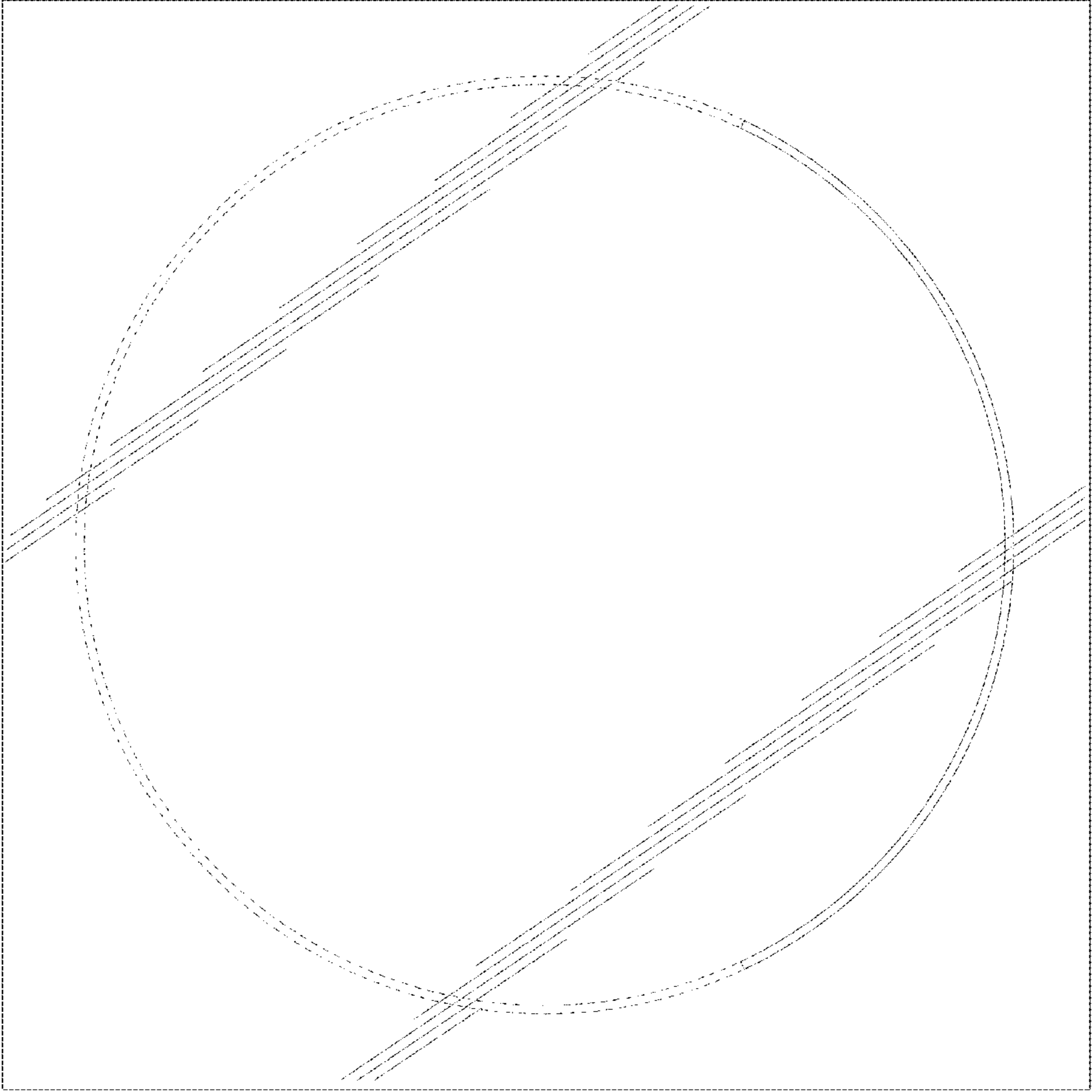

FIG. 7

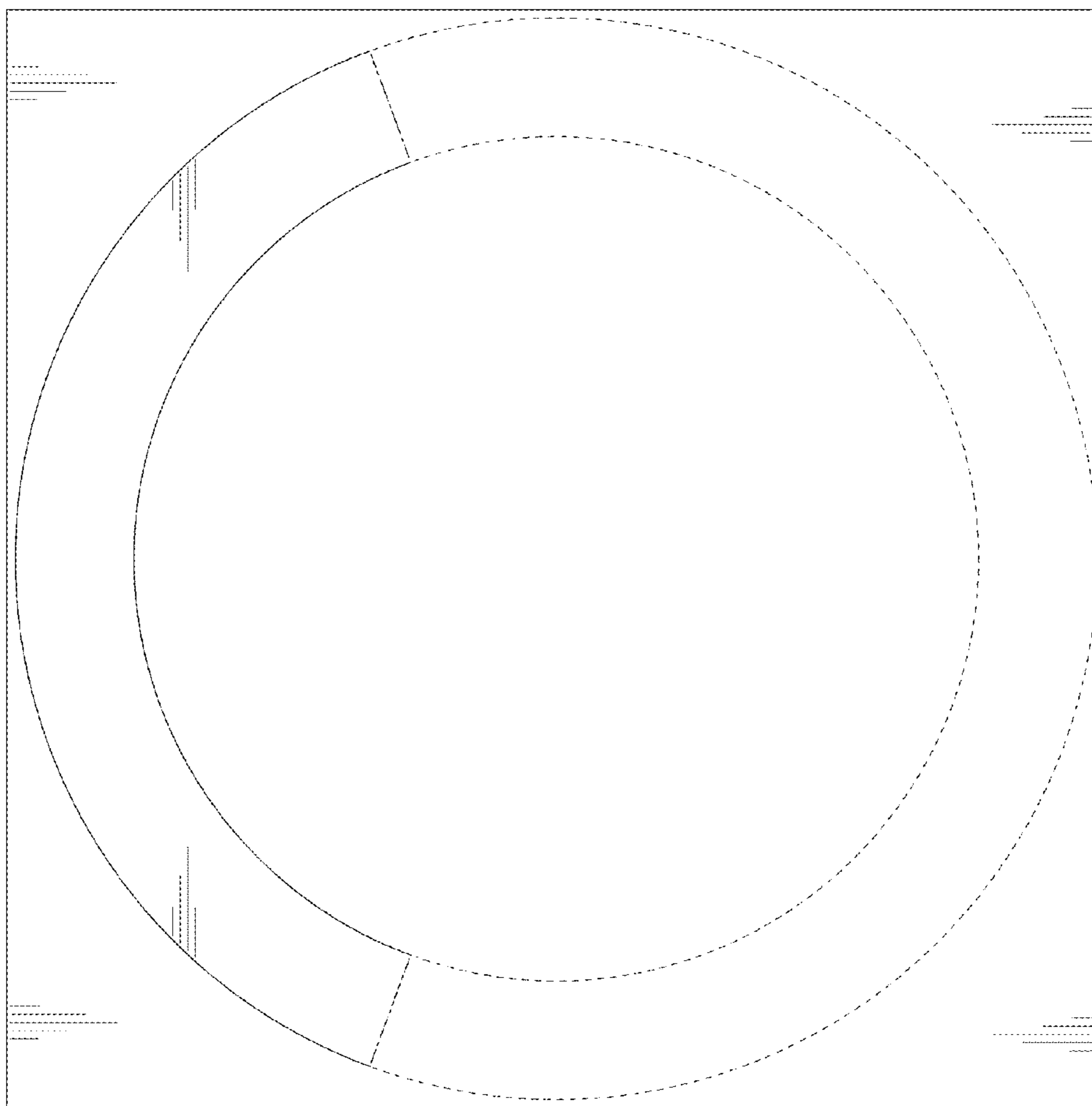

FIG. 8

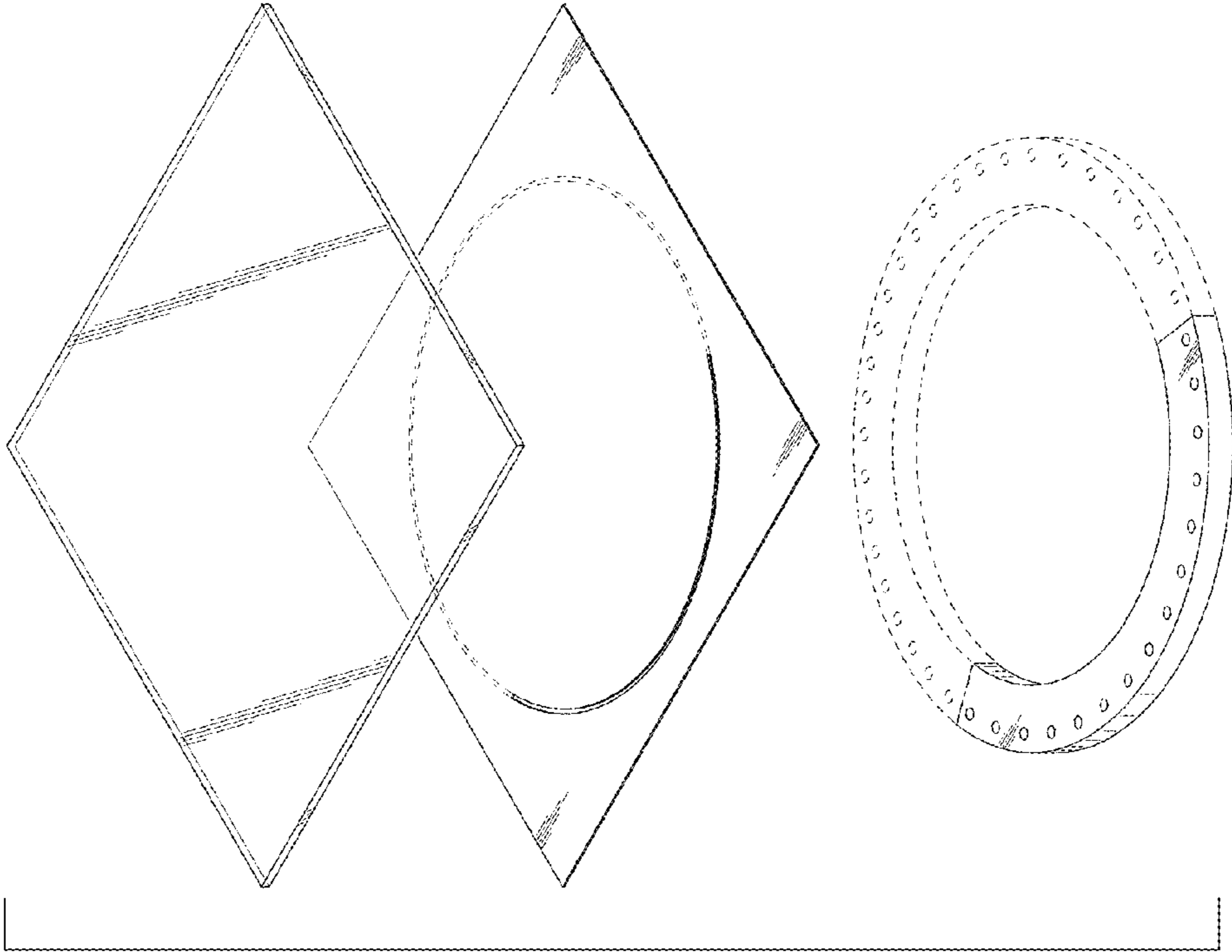

FIG. 9

