



US00D758776S

(12) **United States Design Patent**  
**McKenna et al.**

(10) **Patent No.:** **US D758,776 S**  
(45) **Date of Patent:** **\*\* Jun. 14, 2016**

(54) **PERSONAL WORKSPACE FURNITURE**

(71) Applicant: **STEELCASE, INC.**, Grand Rapids, MI (US)

(72) Inventors: **Mark McKenna**, East Grand Rapids, MI (US); **Mark William Spoelhof**, Grand Rapids, MI (US); **Duck Young Kong**, Beaverton, OR (US); **Keith Robert Machin**, Hopkins, MI (US)

(73) Assignee: **Steelcase, Inc.**, Grand Rapids, MI (US)

(\*\*) Term: **14 Years**

(21) Appl. No.: **29/517,531**

(22) Filed: **Feb. 13, 2015**

(51) **LOC (10) Cl.** ..... **06-01**

(52) **U.S. Cl.**  
USPC ..... **D6/717**

(58) **Field of Classification Search**  
USPC ..... D6/335, 336, 337, 338, 640, 643, 643.1, D6/644, 406.1, 406.2, 406.3, 356, 334, D6/381, 717, 716; D12/318, 345; D25/16  
CPC ..... A47C 17/00; A47C 17/02; A47C 17/12; A47C 17/18; A47C 7/021; A47C 31/00; A47C 3/16

See application file for complete search history.

(56) **References Cited**

**U.S. PATENT DOCUMENTS**

540,515 A	6/1895	Rowlett
817,969 A	4/1906	Galbraith
995,410 A	6/1911	McClure
1,007,498 A	10/1911	Spencer
1,094,812 A	4/1914	Reck
1,234,309 A	7/1917	Dubben
1,391,222 A	9/1921	Fleet
1,489,982 A	4/1924	Dailey
1,502,353 A	7/1924	Simonson

1,548,334 A	8/1925	Sebell
1,659,572 A	2/1928	Klemm
1,661,003 A	2/1928	Miller
1,992,903 A	2/1935	Potashnik
D95,588 S	5/1935	Holsman
2,160,724 A	5/1939	Fletcher
2,266,854 A	12/1941	Davis
2,287,079 A	6/1942	Anderson
2,339,647 A	1/1944	Meyer
2,343,077 A	2/1944	Parrish

(Continued)

**FOREIGN PATENT DOCUMENTS**

FR	2952285 A1	5/2011
GB	2331237 A	5/1999

(Continued)

*Primary Examiner* — Sandra Snapp

(74) *Attorney, Agent, or Firm* — Quarles & Brady, LLP

(57) **CLAIM**

The ornamental design for a personal workspace furniture, as shown and described.

**DESCRIPTION**

FIG. 1 is a top, right, front perspective view of a personal workspace furniture embodying our new design; FIG. 2 is a right side elevational view thereof; FIG. 3 is a left side elevational view thereof; FIG. 4 is a front elevational view thereof; FIG. 5 is a rear elevational view thereof; FIG. 6 is a top plan view thereof; and, FIG. 7 is a bottom plan view thereof.

The broken line representations in the figures illustrate unclaimed environment, and thus form no part of the claimed design. The dash-dot-dash lines define boundaries of the claimed design and form no part of the claimed design.

The nature of this product is a walled enclosure or personal workspace furniture for surrounding a seating area, for example, including a chair and table or desk top.

**1 Claim, 7 Drawing Sheets**

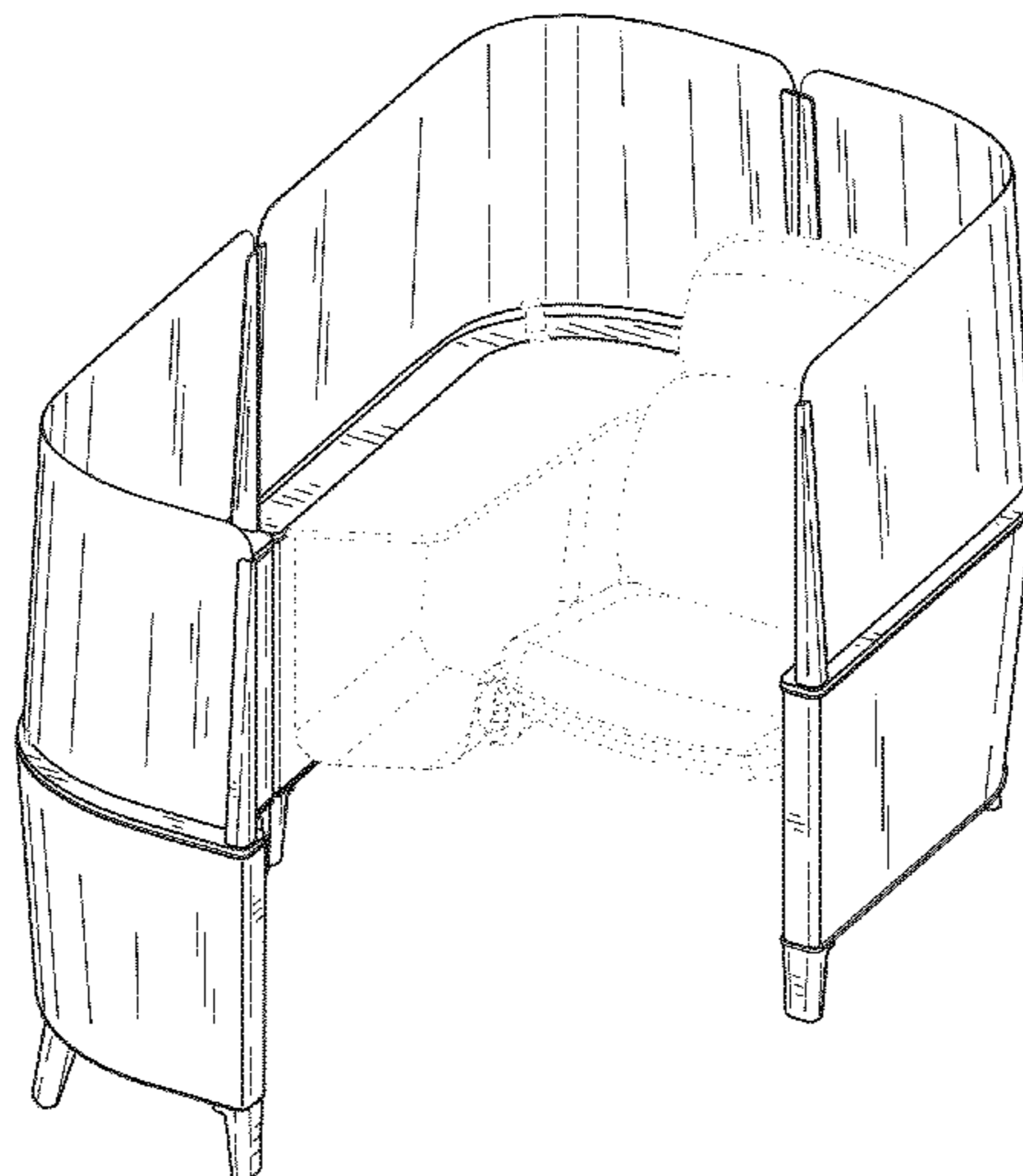

(56)

References Cited

U.S. PATENT DOCUMENTS

D148,242 S *	12/1947	Horsewood .....	D6/336	4,844,388 A	7/1989	Kuba
2,636,224 A	4/1953	Murdoch		4,852,500 A	8/1989	Ryburg
2,694,614 A	11/1954	Dent		4,865,111 A	9/1989	Perutz
D181,945 S	1/1958	Saarinen		4,876,835 A	10/1989	Kelley
D183,416 S	8/1958	Bellmann		D304,529 S	11/1989	Hontz
2,845,699 A	8/1958	Wwoodard		4,914,873 A	4/1990	Newhouse
2,887,154 A	5/1959	Morningstar		4,974,808 A	12/1990	Ball
2,942,924 A	6/1960	Stangert		4,979,554 A	12/1990	Nelson
2,973,028 A	2/1961	Celeste		4,980,998 A	1/1991	Amstutz
2,981,576 A	4/1961	Robinson		4,986,038 A	1/1991	Backer
2,981,583 A	4/1961	Eisenberg		RE33,593 E	5/1991	Herst et al.
2,982,344 A	5/1961	Berlin		5,038,539 A	8/1991	Kelley
2,989,112 A	6/1961	Sonnleitner		5,048,585 A	9/1991	Miller
3,013,642 A	12/1961	Hammitt		D321,407 S	11/1991	Heidmann
3,027,214 A	3/1962	Curatolo		5,092,385 A	3/1992	Beaulieu
D193,889 S	10/1962	Buzzitta		5,097,643 A	3/1992	Wittler
3,128,137 A	4/1964	Dokter		5,104,183 A	4/1992	Madsen
3,142,514 A	7/1964	Ginat		D330,638 S	11/1992	Moschini
3,226,161 A	12/1965	Platner		5,169,210 A	12/1992	Fricano
D205,939 S	10/1966	Laverne		5,228,761 A	7/1993	Huebschen
3,281,185 A	10/1966	Albinson		5,230,289 A	7/1993	George
3,295,283 A	1/1967	Griffith		5,238,300 A	8/1993	Slivon
3,326,147 A	6/1967	Toney		5,246,240 A	9/1993	Romich
D208,413 S	8/1967	Ball		5,277,512 A	1/1994	Dwillies
3,371,454 A	3/1968	Anderson		5,333,928 A	8/1994	Rollinson
D211,464 S	6/1968	Platner		5,339,576 A	8/1994	Fussler
3,389,246 A	6/1968	Shemitz		D350,242 S	9/1994	Lohmeyer
3,425,171 A	2/1969	Propst		D351,294 S	10/1994	Fleishman
3,441,310 A	4/1969	Gale		5,368,359 A	11/1994	Eakin
3,521,929 A	7/1970	Pearson		D353,946 S	1/1995	Fischer et al.
3,528,717 A	9/1970	Kinnebrew		5,377,598 A	1/1995	Kirchner
D219,376 S	12/1970	Pearson		5,394,668 A	3/1995	Lim
3,582,170 A	6/1971	Schaeffer		5,398,901 A	3/1995	Brodmann
D226,648 S	4/1973	Sebel et al.		D358,514 S	5/1995	Lovegrove
D227,832 S	7/1973	Leaver		5,429,336 A	7/1995	Ko
3,744,868 A	7/1973	Reiter		5,473,994 A	12/1995	Foley
3,811,728 A *	5/1974	Redemske .....	A47B 83/00 297/440.14	5,537,766 A	7/1996	Nickens
3,841,042 A	10/1974	Siegal		5,564,667 A	10/1996	Copeland
D242,099 S	11/1976	Casey		5,577,818 A	11/1996	Sayre
D242,100 S	11/1976	Casey		D382,122 S	8/1997	Thorp et al.
D246,082 S	10/1977	Friedrich		5,653,499 A	8/1997	Goodall
4,097,918 A	6/1978	Anderson		5,660,432 A	8/1997	Davis
4,109,429 A	8/1978	Whisson		D385,423 S	10/1997	Shields
4,164,009 A	8/1979	Maguire, Jr.		5,683,064 A	11/1997	Copeland
4,191,420 A	3/1980	Fassett		D390,021 S	2/1998	Smith
4,226,190 A	10/1980	Ashton		D392,114 S	3/1998	Thorp et al.
D257,601 S	12/1980	Cyplik		5,727,841 A	3/1998	Morley
D257,604 S	12/1980	Cyplik		5,765,315 A	6/1998	Nagamitsu
4,307,672 A	12/1981	Shikimi		5,816,649 A	10/1998	Shields
4,312,515 A	1/1982	Allori		5,826,639 A	10/1998	Miller
D264,402 S	5/1982	Yellen		5,826,941 A	10/1998	Olsen
4,351,475 A	9/1982	Hudson		D402,476 S	12/1998	Thorp et al.
4,367,370 A	1/1983	Wilson		D406,228 S	3/1999	Vogels
4,427,232 A	1/1984	Malm		5,875,597 A	3/1999	Gingrich
4,448,003 A	5/1984	Hasbrouck		D409,419 S	5/1999	Wilkinson
D278,003 S *	3/1985	Gagliano .....	D6/336	5,931,102 A	8/1999	Grahl
4,616,798 A	10/1986	Smeenge		5,931,528 A	8/1999	Shields
4,624,083 A	11/1986	Diffrient		5,947,034 A	9/1999	Belka
D286,956 S	12/1986	Lockwood		5,967,600 A	10/1999	Jelacic
4,631,881 A	12/1986	Charman		D415,901 S	11/1999	Arko et al.
D288,506 S	3/1987	Ochsner		5,979,118 A	11/1999	Gortsema
4,666,118 A	5/1987	Busche		6,000,560 A	12/1999	Barkan
4,685,255 A	8/1987	Kelley		6,015,120 A	1/2000	Sweere
4,687,167 A	8/1987	Skalka		D425,321 S	5/2000	Tholkes et al.
4,712,336 A	12/1987	Backer		6,059,364 A	5/2000	Dryburgh
4,715,154 A	12/1987	Baloga		6,086,034 A	7/2000	McAllister
D293,981 S	2/1988	Ball		6,101,954 A	8/2000	Rein
D296,731 S	7/1988	Hollington		6,102,476 A	8/2000	May
4,761,922 A	8/1988	Black		6,142,559 A	11/2000	Sorel
4,779,540 A	10/1988	Dion		6,145,926 A	11/2000	Lin
4,795,355 A	1/1989	Dorn		6,170,786 B1	1/2001	Park
4,826,245 A	5/1989	Entratter		D439,063 S	3/2001	Round et al.
4,830,614 A	5/1989	Schricker		D439,425 S	3/2001	Park et al.
4,835,915 A	6/1989	Nilssen		D440,064 S	4/2001	Deacon
				6,213,191 B1	4/2001	Nitzsche
				D441,968 S	5/2001	Lin
				6,250,019 B1	6/2001	Simons, Jr.
				D446,659 S	8/2001	Ludwig et al.
				6,286,275 B1	9/2001	Edwards



(56)

References Cited

U.S. PATENT DOCUMENTS

D449,169 S	10/2001	Bennie et al.	D616,209 S *	5/2010	Singler	D6/338
6,295,764 B1	10/2001	Berridge	7,721,991 B2	5/2010	Johnson	
6,296,216 B1	10/2001	Law	7,726,732 B1	6/2010	Keating	
D452,559 S	12/2001	Schonberger et al.	D621,329 S	8/2010	Bock	
6,327,982 B1	12/2001	Jackson	D621,330 S	8/2010	Bock	
D456,182 S	4/2002	Hamilton et al.	D621,331 S	8/2010	Bock	
6,375,119 B2	4/2002	Park	7,827,920 B2	11/2010	Beck	
6,375,257 B1	4/2002	Wooding	7,887,014 B2	2/2011	Lindblad	
D457,359 S	5/2002	Chan	7,938,372 B2	5/2011	MacLeod	
6,386,723 B1	5/2002	Eberlein	D640,074 S	6/2011	Hamilton et al.	
6,394,689 B1	5/2002	Kuo	D643,042 S	8/2011	Saelid	
D460,274 S	7/2002	Bennie et al.	7,997,211 B2	8/2011	Peterson	
D460,630 S	7/2002	Ritch et al.	7,997,531 B2	8/2011	Bettell	
6,422,646 B1	7/2002	McNally	7,997,654 B2	8/2011	Ferry	
6,453,826 B1	9/2002	Fookes	8,011,723 B2	9/2011	Park	
D465,049 S	10/2002	Ludwig	D646,085 S	10/2011	Overthun et al.	
6,484,647 B2	11/2002	Lininger, Jr.	D648,553 S	11/2011	Wilson et al.	
6,487,978 B1	12/2002	Hamberg	8,046,957 B2	11/2011	Towersey	
6,497,075 B1	12/2002	Schreiner	D653,884 S	2/2012	Ferry et al.	
6,527,406 B1	3/2003	Slesinger	8,162,519 B2	4/2012	Salter	
6,629,722 B1	10/2003	Tang	D659,427 S *	5/2012	Nicolas	D6/644
D482,536 S *	11/2003	Williams	D659,428 S *	5/2012	Nicolas	D6/644
6,644,748 B2	11/2003	Tholkes	8,177,165 B2	5/2012	Bettell	
6,659,159 B2	12/2003	Fritsche	8,191,487 B2	6/2012	Theesfeld	
6,662,732 B2	12/2003	Birsel	8,201,885 B2	6/2012	Thompson	
6,663,267 B2	12/2003	Newhouse	D663,256 S	7/2012	Collins et al.	
6,695,270 B1	2/2004	Smed	8,215,041 B2	7/2012	Hill	
D488,163 S	4/2004	Hunt	8,215,065 B2	7/2012	Gallant	
6,742,307 B2	6/2004	Briskman	8,225,723 B2	7/2012	Nakamura	
6,748,710 B2	6/2004	Gresham	D668,257 S	10/2012	Tsai	
6,769,747 B2	8/2004	Chan	8,276,867 B2	10/2012	Hung	
D503,549 S	4/2005	Nicoletti	8,291,833 B2	10/2012	Skiba	
D506,331 S	6/2005	Quintal	8,312,653 B2	11/2012	Fritsche	
D508,787 S	8/2005	Natuzzi	8,313,060 B2	11/2012	Darbyshire	
D510,816 S	10/2005	Lee	8,322,802 B2	12/2012	Boxenbaum	
7,032,523 B2	4/2006	Forslund, III	8,327,589 B2	12/2012	Sutton	
D520,263 S	5/2006	Nobles et al.	8,365,798 B2	2/2013	Feldpausch	
7,036,438 B2	5/2006	Okamoto	D677,477 S	3/2013	Agati et al.	
7,082,882 B2	8/2006	Heimbrock	8,414,076 B2	4/2013	Plant	
7,134,719 B2	11/2006	Moglin	8,434,825 B2	5/2013	Wesselink	
7,178,469 B2	2/2007	Goza	8,485,470 B2	7/2013	Hankinson	
D538,060 S *	3/2007	Golino	8,596,206 B2	12/2013	Legeay	
D540,565 S *	4/2007	Nakamura	8,616,137 B2	12/2013	Collins	
7,207,629 B2	4/2007	Goetz	8,667,908 B2	3/2014	Martin	
D552,362 S	10/2007	Bouroullec et al.	8,668,257 B2	3/2014	Wu	
D557,916 S	12/2007	Dietrich	D702,068 S	4/2014	Mitten et al.	
D558,993 S	1/2008	Saint-Jalmes et al.	8,690,254 B2	4/2014	Cailleteau	
D559,002 S	1/2008	Williams et al.	D720,160 S *	12/2014	Lloyd	D6/643
7,318,622 B2	1/2008	Rezag	2001/0003960 A1	6/2001	Lininger et al.	
D564,764 S	3/2008	Springer et al.	2002/0181229 A1	12/2002	Wei	
7,357,086 B2	4/2008	Petrick	2003/0085597 A1	5/2003	Ludeke et al.	
D568,062 S	5/2008	Newhouse	2003/0132356 A1	7/2003	Copeland	
D569,647 S	5/2008	Mezger	2004/0007904 A1	1/2004	Lin et al.	
7,419,214 B2	9/2008	Plant	2004/0065235 A1	4/2004	de Oliveira	
7,427,101 B1	9/2008	Zernov	2004/0250480 A1	12/2004	Matthai	
D579,224 S	10/2008	Fancelli	2005/0067865 A1	3/2005	Yu	
D582,173 S	12/2008	Dordoni	2005/0140184 A1 *	6/2005	Williams	A47C 13/00 297/135
D583,579 S	12/2008	Pearson et al.				
D584,901 S	1/2009	Massaud	2006/0097553 A1	5/2006	Spurlock et al.	
7,481,170 B2	1/2009	Sommerfield	2007/0261315 A1	11/2007	Ludwig et al.	
7,506,772 B2	3/2009	Chen	2007/0271856 A1	11/2007	Ludwig et al.	
7,517,010 B2	4/2009	Saint-Jalmes	2007/0278361 A1	12/2007	May et al.	
7,523,888 B2	4/2009	Ferry	2009/0050740 A1	2/2009	Saint-Jalmes et al.	
D591,520 S	5/2009	Orson et al.	2009/0146006 A1	6/2009	Park et al.	
D596,864 S	7/2009	Bergmann et al.	2009/0212669 A1	8/2009	Robert-Reitman et al.	
D599,122 S	9/2009	Feldpausch et al.	2009/0243352 A1	10/2009	Cailleteau	
D600,930 S	9/2009	Overthun et al.	2009/0302158 A1	12/2009	Darbyshire et al.	
7,641,962 B2	1/2010	Sutton	2010/0301162 A1	12/2010	Hankinson	
D609,037 S	2/2010	Miller et al.	2011/0011977 A1	1/2011	Olliges	
D610,377 S	2/2010	Kita	2011/0186682 A1	8/2011	Collins et al.	
7,677,182 B2	3/2010	Mueller	2011/0210204 A1	9/2011	Collins et al.	
D615,919 S	5/2010	Bock				

(56)

**References Cited**

FOREIGN PATENT DOCUMENTS

U.S. PATENT DOCUMENTS

2011/0253838 A1 10/2011 Bettell  
2011/0289859 A1 12/2011 Picchio  
2012/0037776 A1 2/2012 Hung  
2012/0186164 A1 7/2012 Pensi  
2012/0235453 A1 9/2012 Bechtold et al.  
2012/0313406 A1 12/2012 Darbyshire et al.  
2012/0318918 A1 12/2012 Johnson et al.  
2013/0180940 A1 7/2013 Tsai

GB 2362095 A 11/2001  
JP H03101248 U 10/1991  
JP H08258796 A 10/1996  
JP 2003135163 A 5/2003  
JP 2005334407 A 12/2005  
WO 2008031506 A1 3/2008  
WO 2008133953 A1 11/2008  
WO 2013144845 A2 10/2013

\* cited by examiner

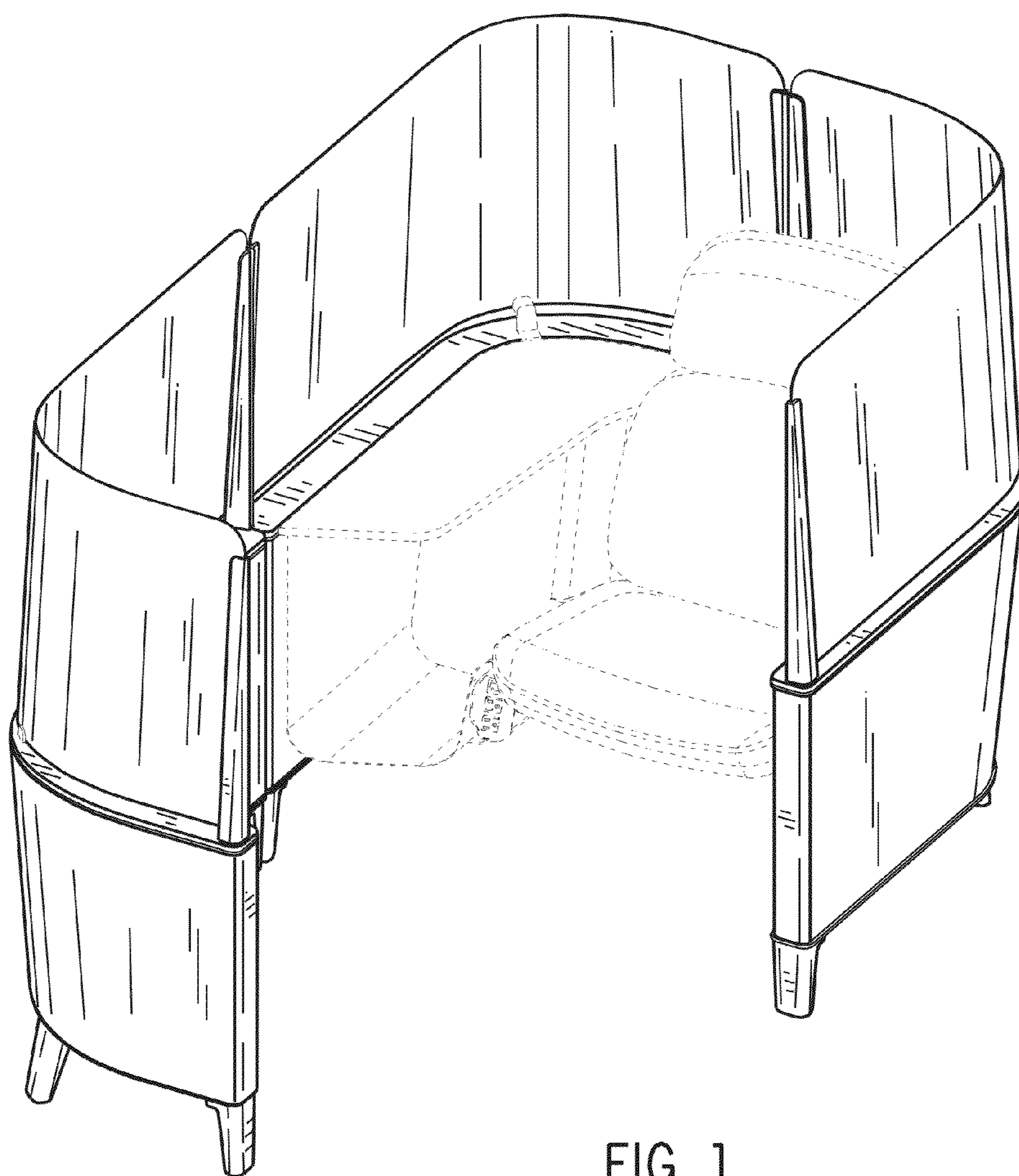

FIG. 1



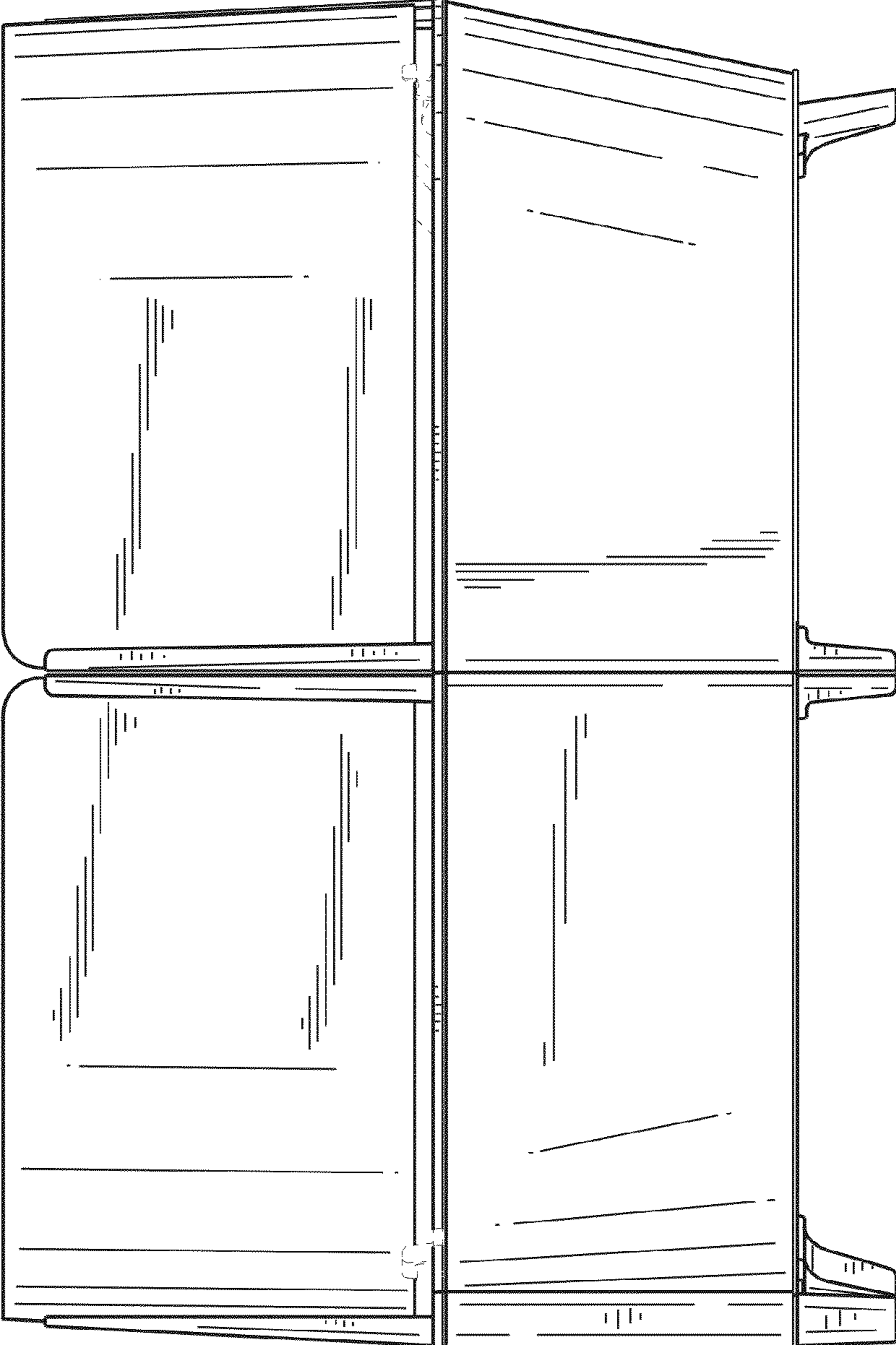

FIG. 2

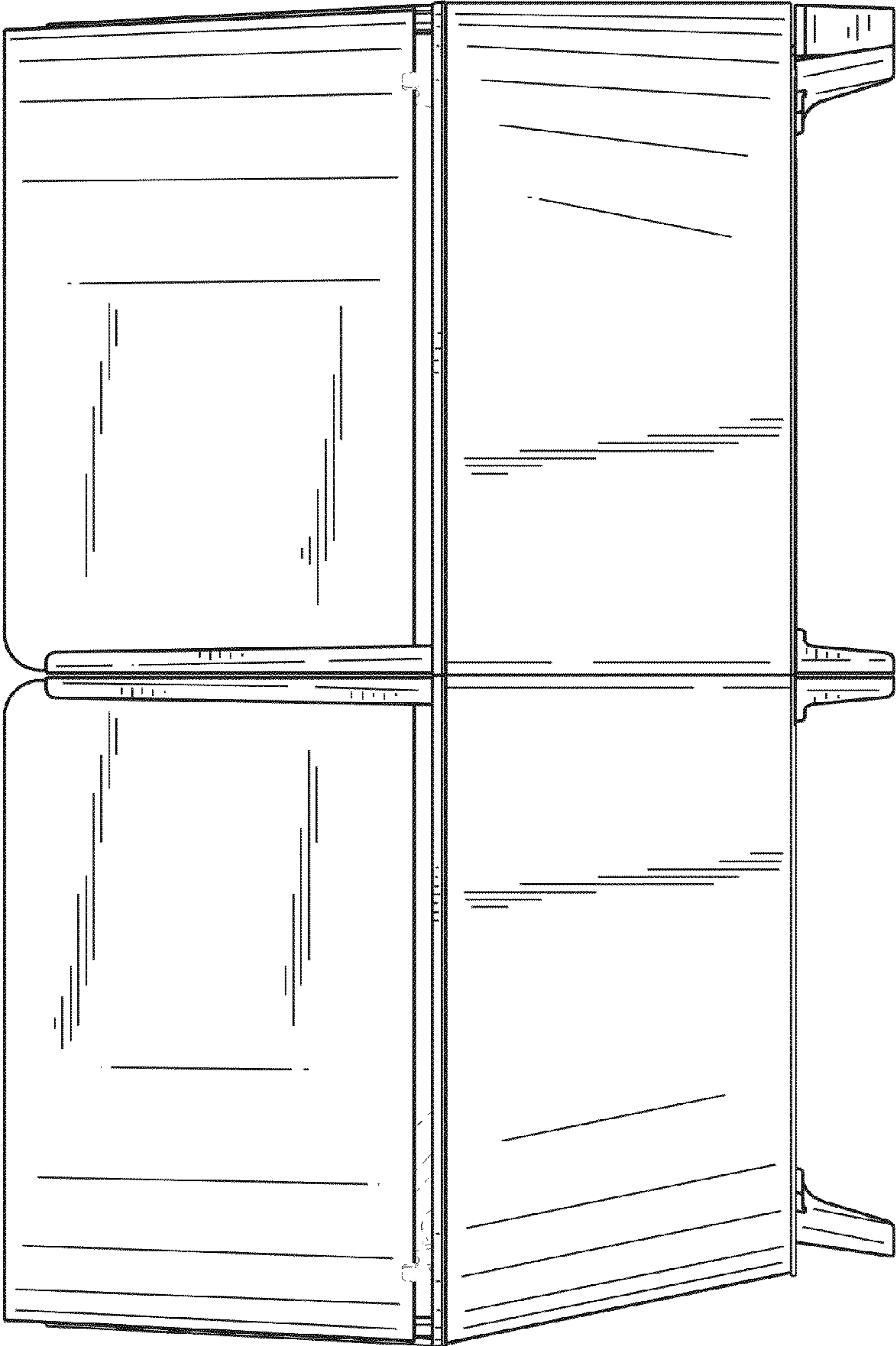

FIG. 3

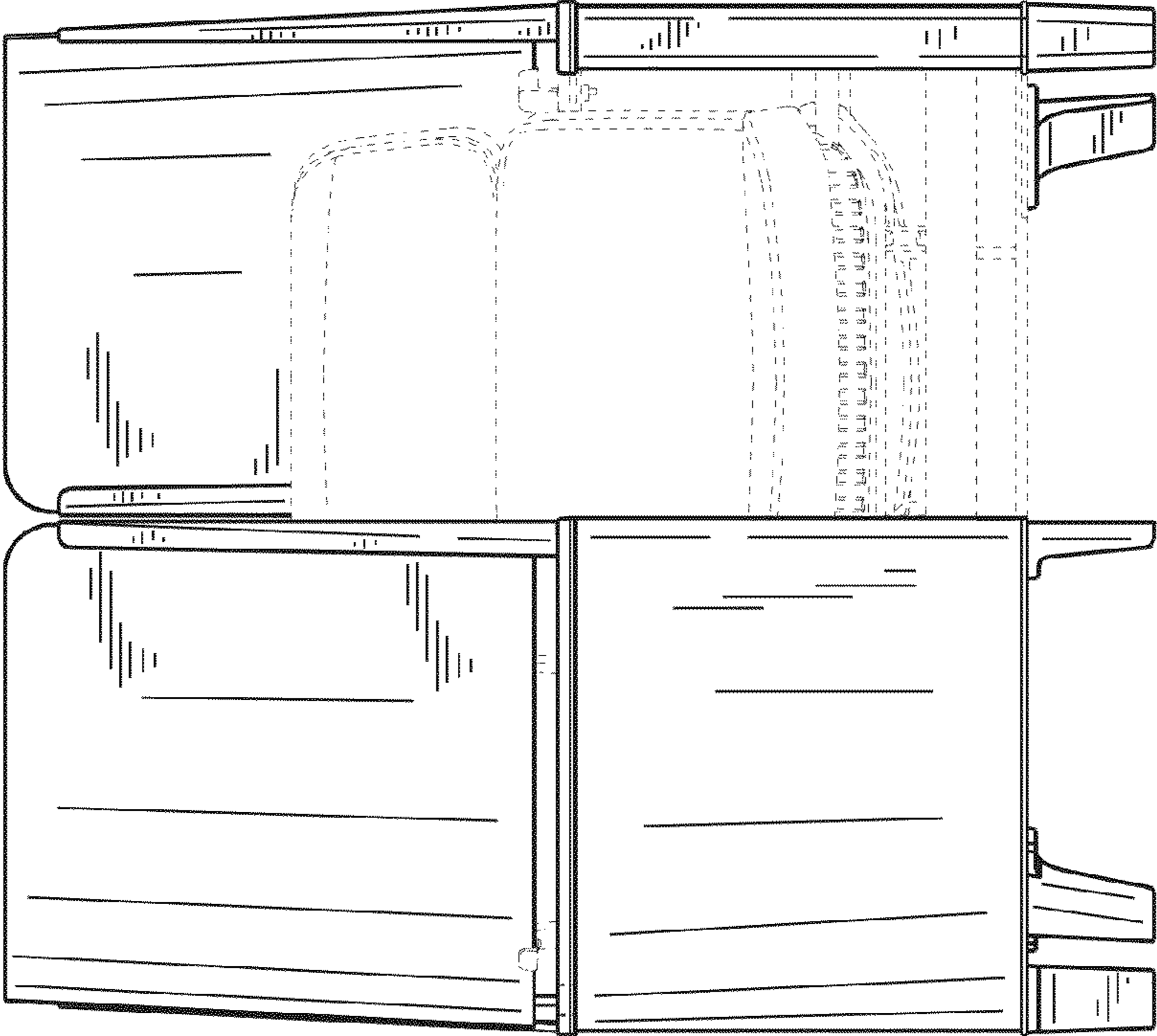

FIG. 4



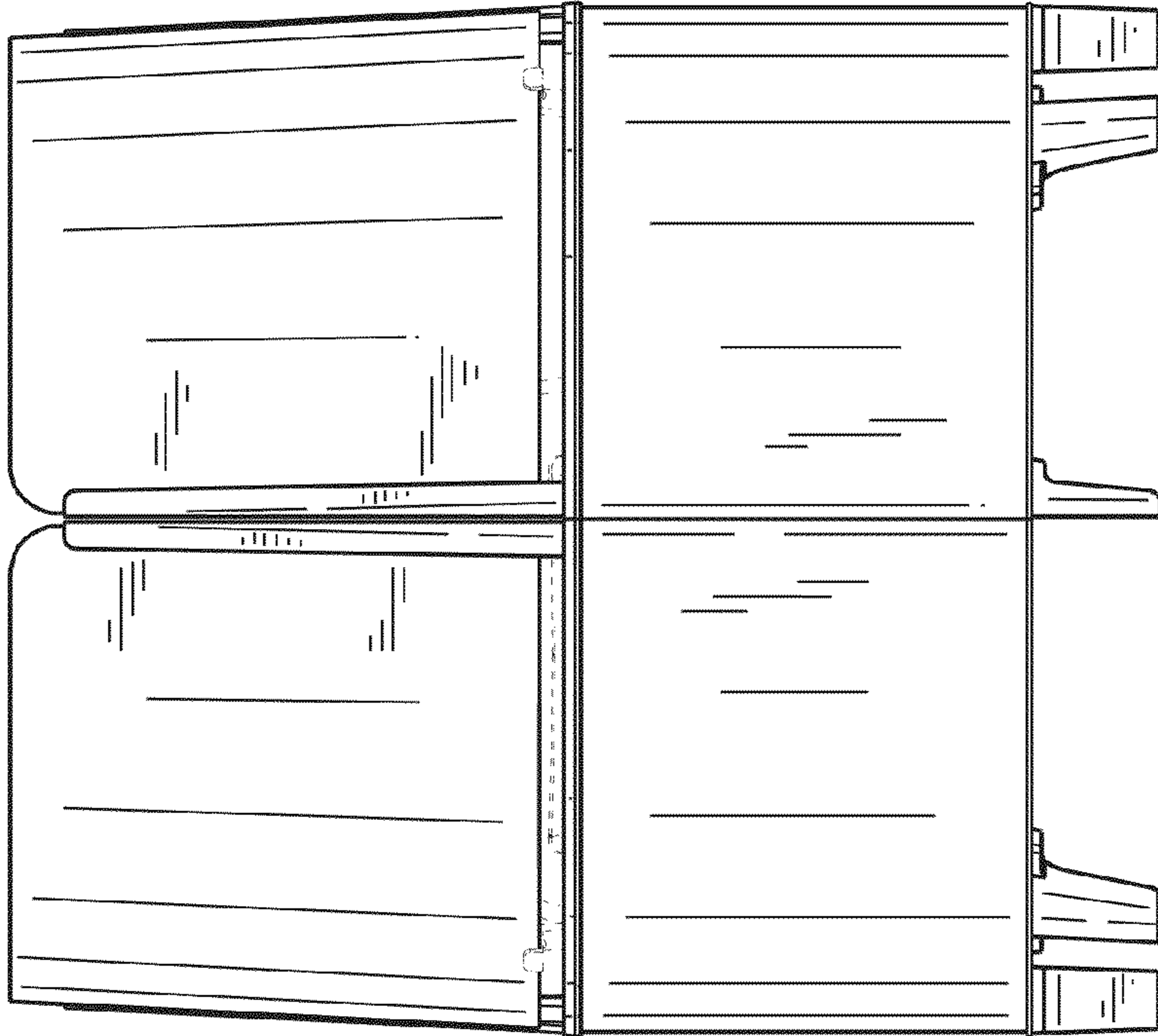

FIG. 5

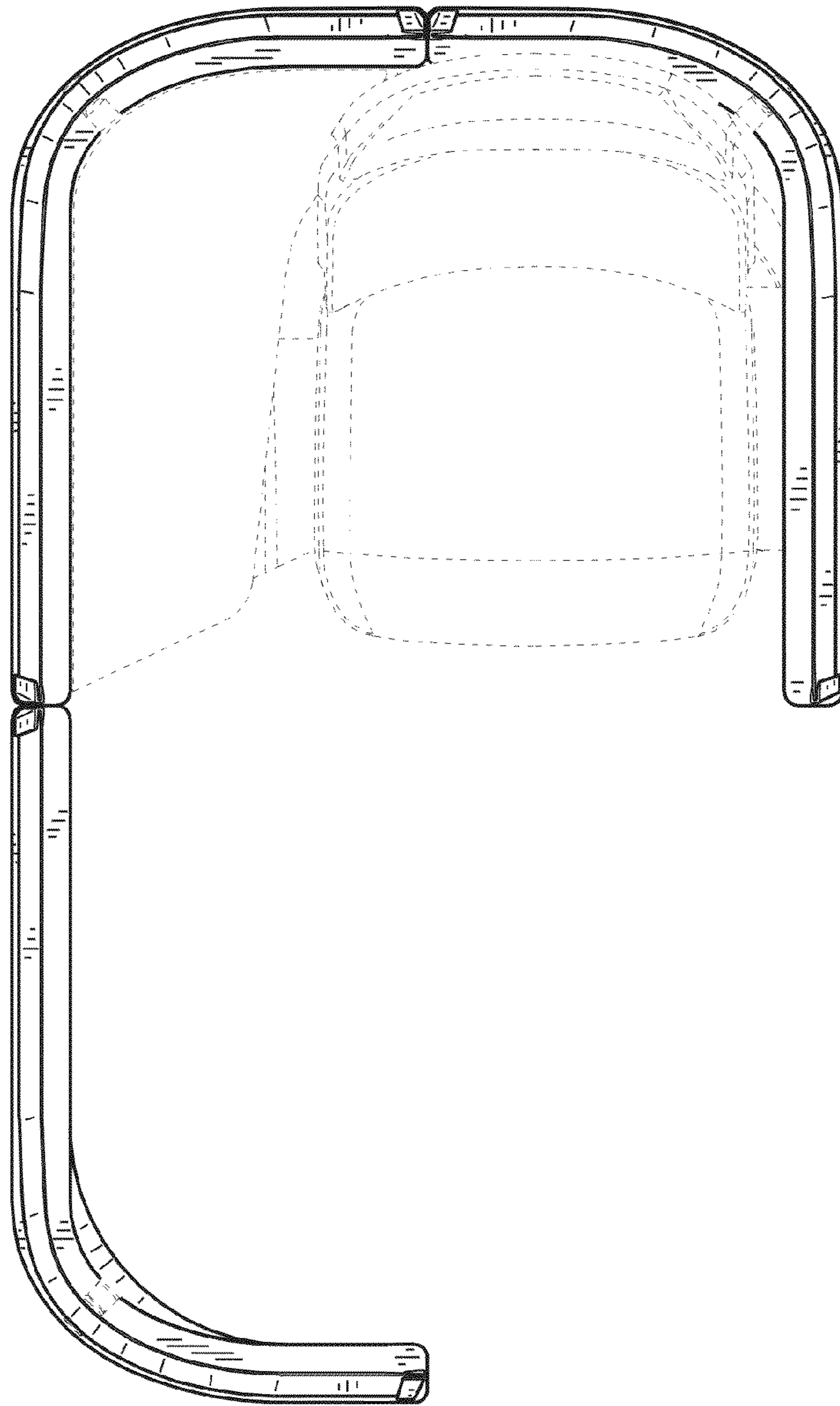

FIG. 6

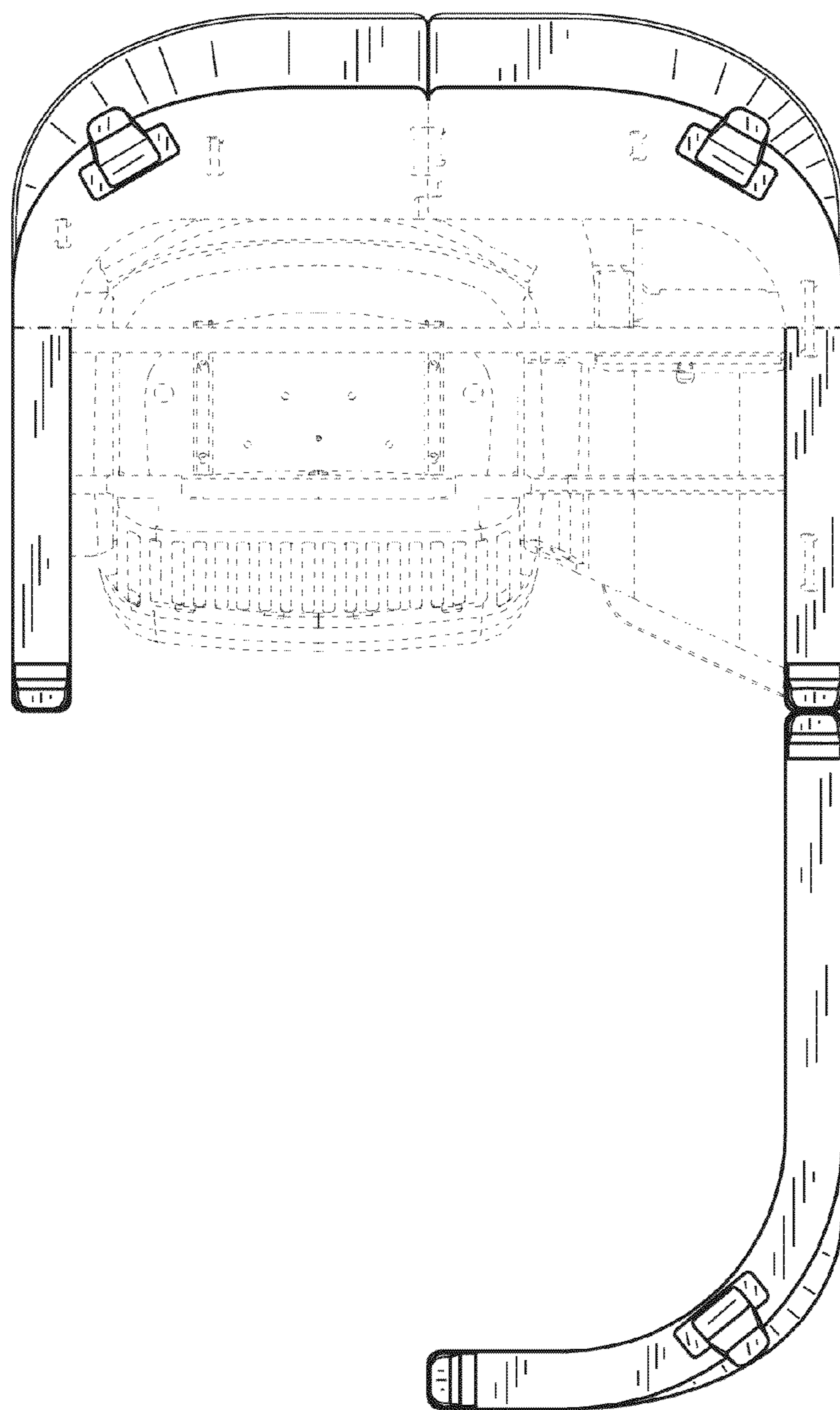

FIG. 7



UNITED STATES PATENT AND TRADEMARK OFFICE  
**CERTIFICATE OF CORRECTION**

PATENT NO. : D758,776 S  
APPLICATION NO. : 29/517531  
DATED : June 14, 2016  
INVENTOR(S) : McKenna et al.

Page 1 of 1

It is certified that error appears in the above-identified patent and that said Letters Patent is hereby corrected as shown below:

Item (73) Assignee: "Steelcase, Inc." should be --Steelcase Inc.--

Signed and Sealed this  
Twenty-first Day of February, 2017



Michelle K. Lee  
*Director of the United States Patent and Trademark Office*