



US00D758746S

(12) **United States Design Patent**  
**Varghese-Abraham**

(10) **Patent No.:** **US D758,746 S**  
(45) **Date of Patent:** **\*\* Jun. 14, 2016**

- (54) **CLOTHES HANGER ACCESSORY**
- (71) Applicant: **Annie Varghese-Abraham**, Frisco, TX (US)
- (72) Inventor: **Annie Varghese-Abraham**, Frisco, TX (US)
- (\*\*) Term: **14 Years**
- (21) Appl. No.: **29/519,880**
- (22) Filed: **Mar. 9, 2015**
- (51) **LOC (10) Cl.** ..... **06-08**
- (52) **U.S. Cl.**  
USPC ..... **D6/328; D6/323**
- (58) **Field of Classification Search**  
USPC ..... D6/315-328, 513, 672, 677;  
223/85-98; 211/10, 13.1, 85.2, 86.01,  
211/87.01, 113; D3/315, 317, 903  
CPC ..... A47G 25/14; A47G 25/28; A47G 25/26;  
A47G 25/30; A47G 25/36; A47G 25/50;  
A47G 25/442; A47G 25/483; A47G 25/743;  
A47G 25/4023; A47F 5/0006  
See application file for complete search history.

(56) **References Cited**

**U.S. PATENT DOCUMENTS**

|           |   |   |         |           |       |                        |
|-----------|---|---|---------|-----------|-------|------------------------|
| D39,270   | S | * | 4/1908  | Wiggin    | ..... | D6/328                 |
| D40,578   | S | * | 3/1910  | Kirchner  | ..... | 211/87.01              |
| 2,137,268 | A | * | 11/1938 | Clairon   | ..... | A47G 25/60<br>223/86   |
| D128,789  | S | * | 8/1941  | Rhodes    | ..... | 223/88                 |
| 3,081,881 | A | * | 3/1963  | Seeger    | ..... | A47G 25/743<br>211/113 |
| D264,911  | S | * | 6/1982  | Annis     | ..... | D6/316                 |
| 4,573,585 | A | * | 3/1986  | Frei      | ..... | A45C 11/16<br>206/493  |
| D323,755  | S | * | 2/1992  | Harney    | ..... | D6/513                 |
| 5,240,120 | A | * | 8/1993  | McDonough | ..... | A47F 7/02<br>206/495   |

|              |    |   |         |                  |       |                        |
|--------------|----|---|---------|------------------|-------|------------------------|
| D546,080     | S  | * | 7/2007  | Chen             | ..... | D6/323                 |
| 7,377,409    | B1 | * | 5/2008  | Brown            | ..... | A47G 25/16<br>211/85.2 |
| 8,070,025    | B1 | * | 12/2011 | Nelson           | ..... | A47G 25/14<br>211/85.2 |
| 8,651,291    | B1 | * | 2/2014  | Prather          | ..... | A45C 11/16<br>211/113  |
| 9,215,943    | B1 | * | 12/2015 | Varghese-Abraham | ..... | A47G 25/16             |
| 2013/0299527 | A1 | * | 11/2013 | Mazyck           | ..... | A47G 25/16<br>223/88   |

\* cited by examiner

*Primary Examiner* — Derrick Holland

*Assistant Examiner* — Lauren Calve

(74) *Attorney, Agent, or Firm* — James R. Gourley; Carstens & Cahoon, LLP

(57) **CLAIM**

The ornamental design for a clothes hanger accessory, as shown and described.

**DESCRIPTION**

FIG. 1 is a rear perspective view of a clothes hanger accessory of the present invention;  
 FIG. 2 is a front perspective view of the clothes hanger accessory of the present invention;  
 FIG. 3 is a rear elevation view of the clothes hanger accessory of the present invention;  
 FIG. 4 is a front elevation view of the clothes hanger accessory of the present invention;  
 FIG. 5 is a top elevation view of the clothes hanger accessory of the present invention; and  
 FIG. 6 is a bottom elevation view of the clothes hanger accessory of the present invention;  
 FIG. 7 is a right side elevation view of the clothes hanger accessory of the present invention; and,  
 FIG. 8 is a left side elevation view of the clothes hanger accessory of the present invention.

**1 Claim, 6 Drawing Sheets**

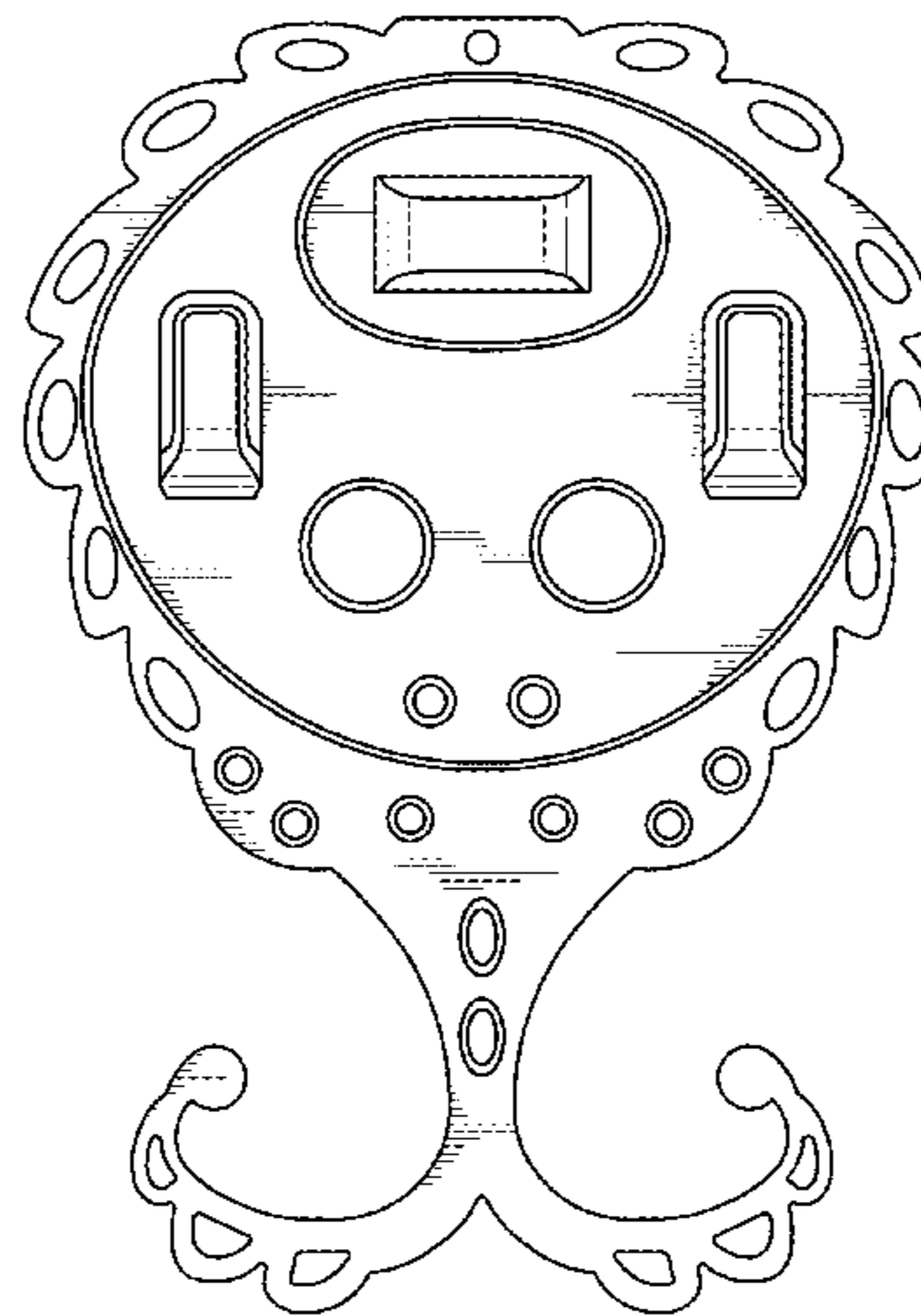
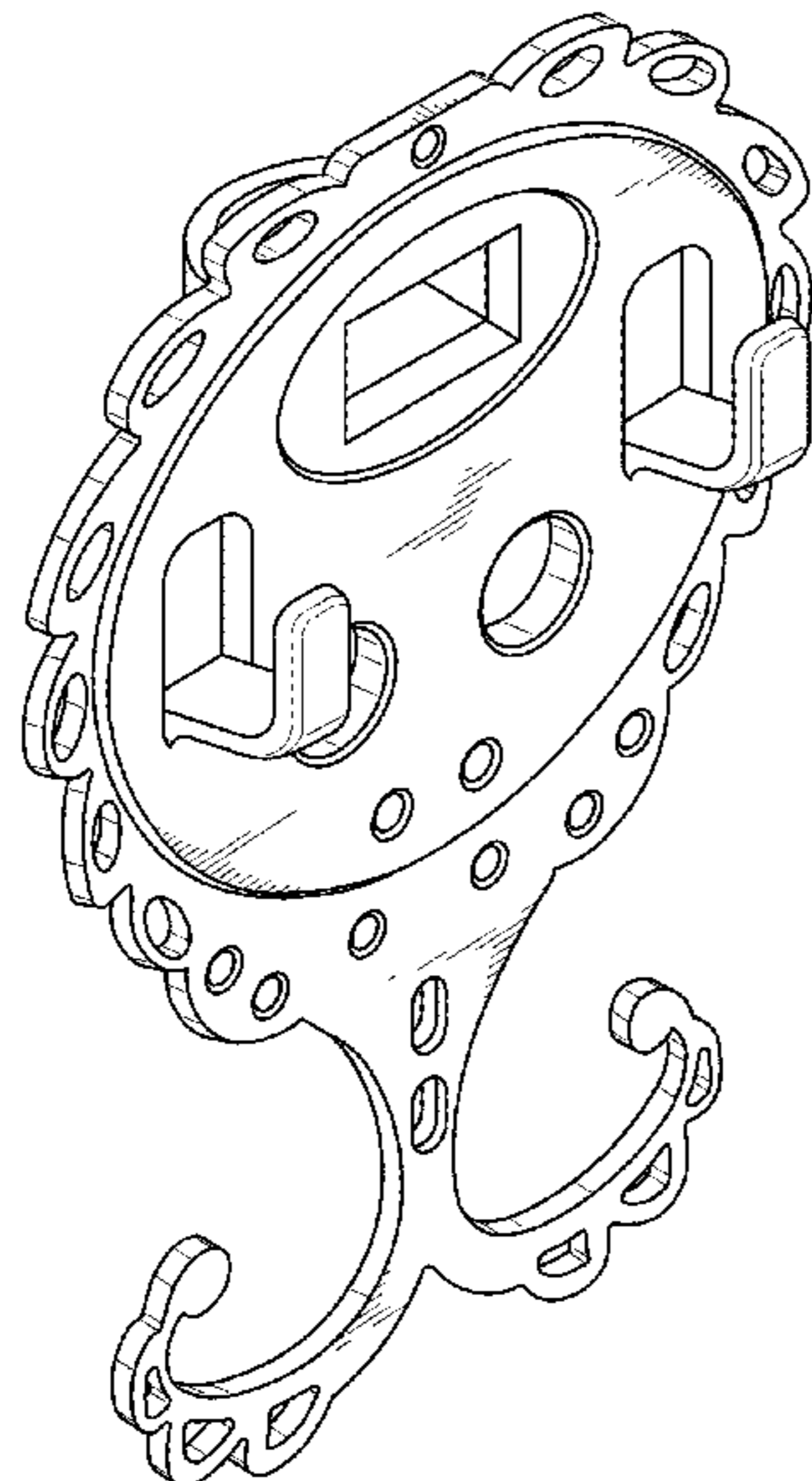

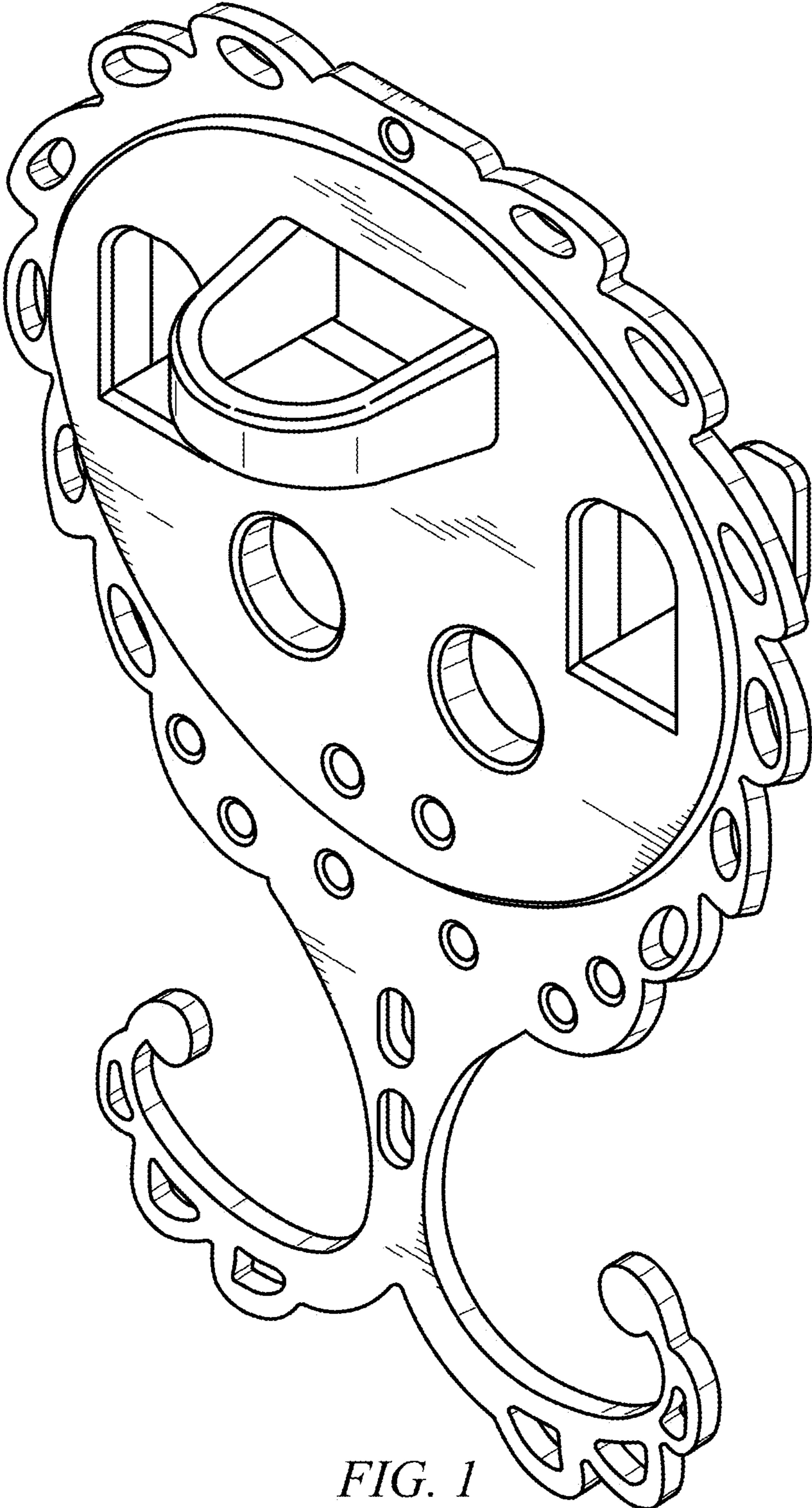

FIG. 1

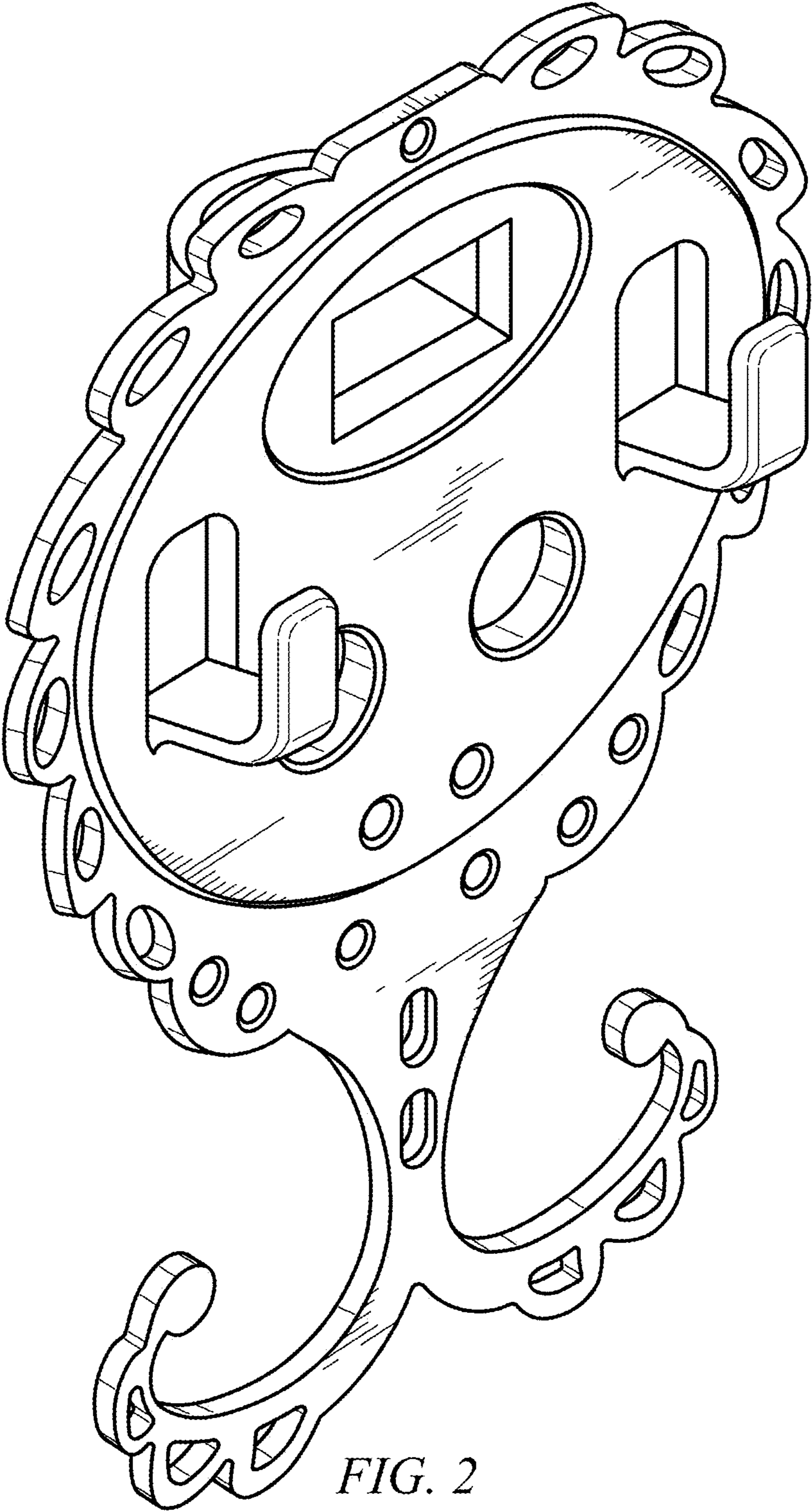

FIG. 2



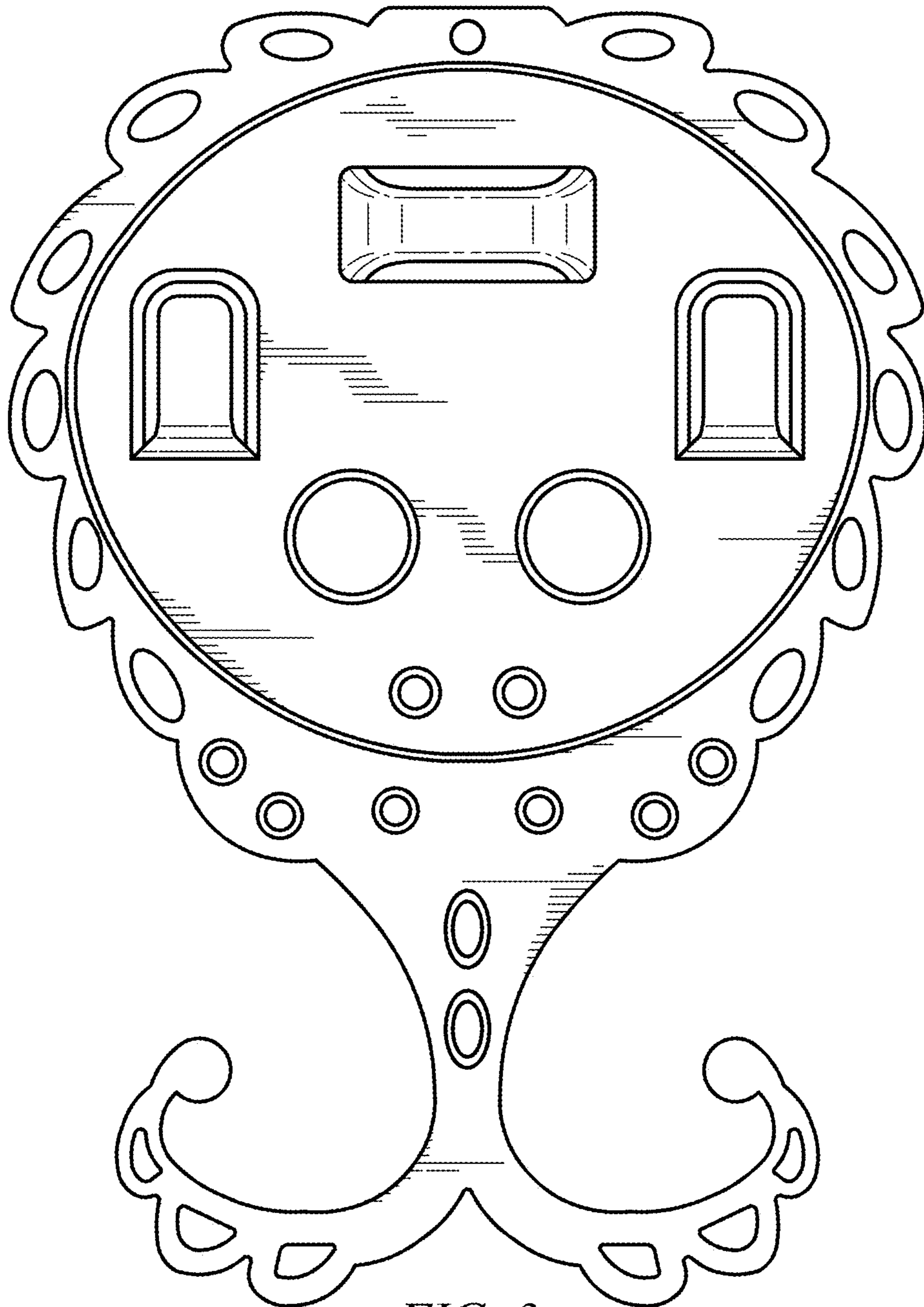

FIG. 3

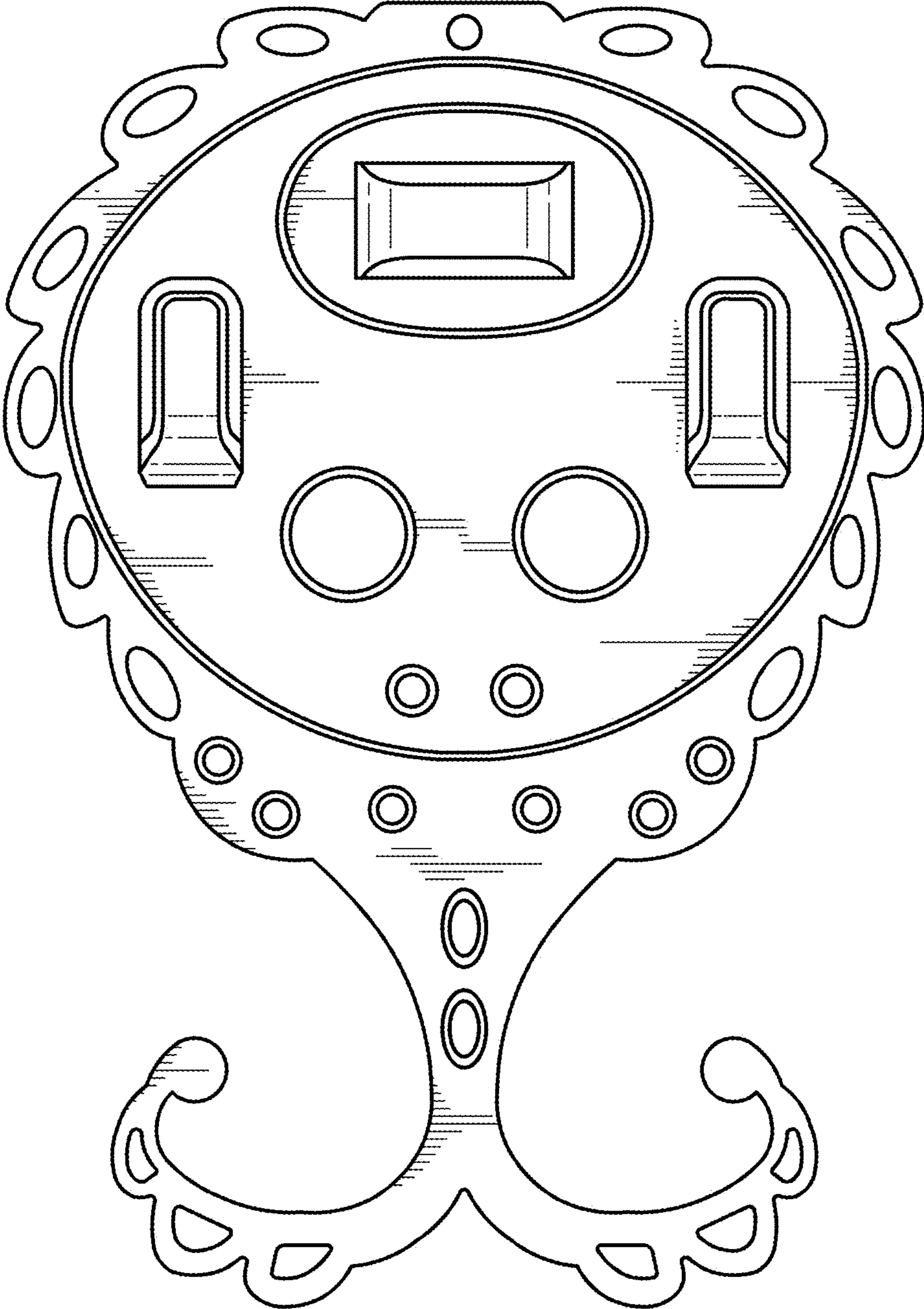

FIG. 4

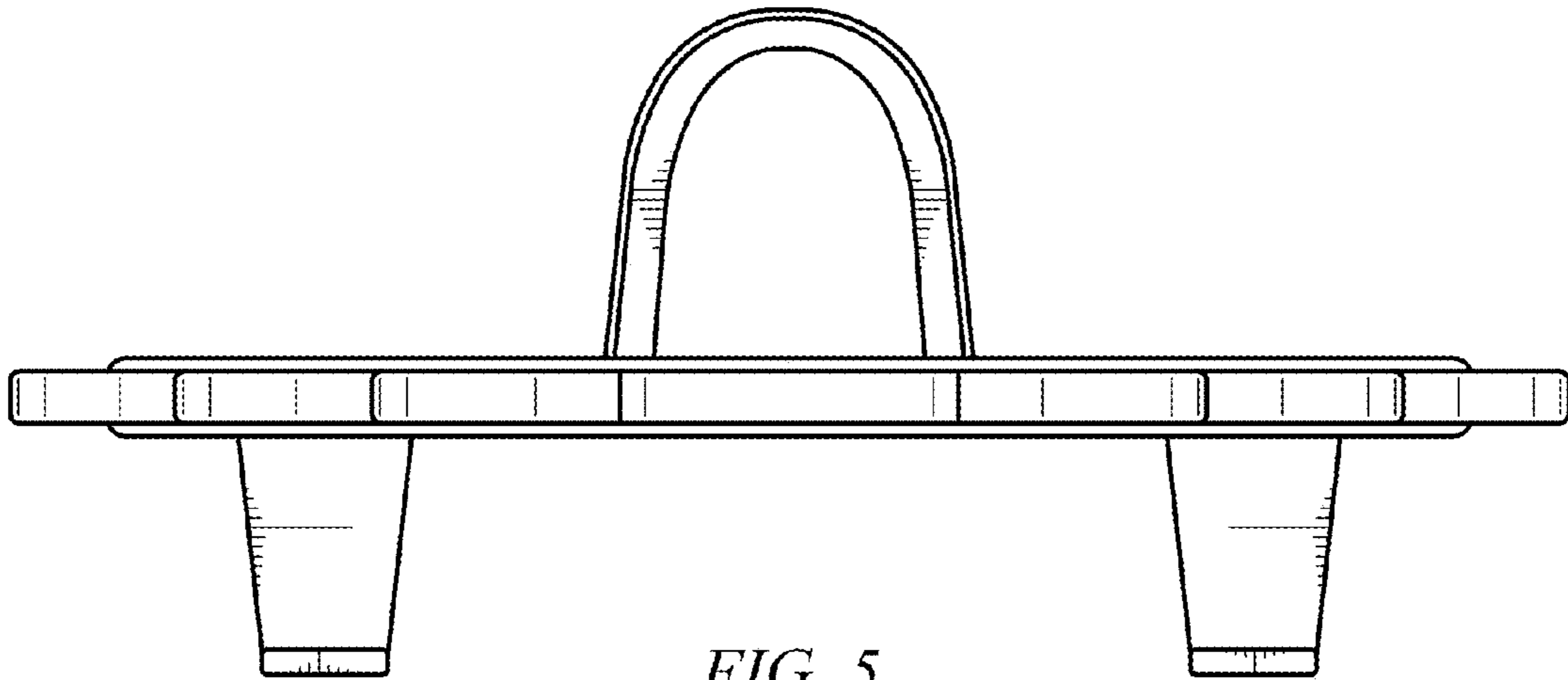

FIG. 5

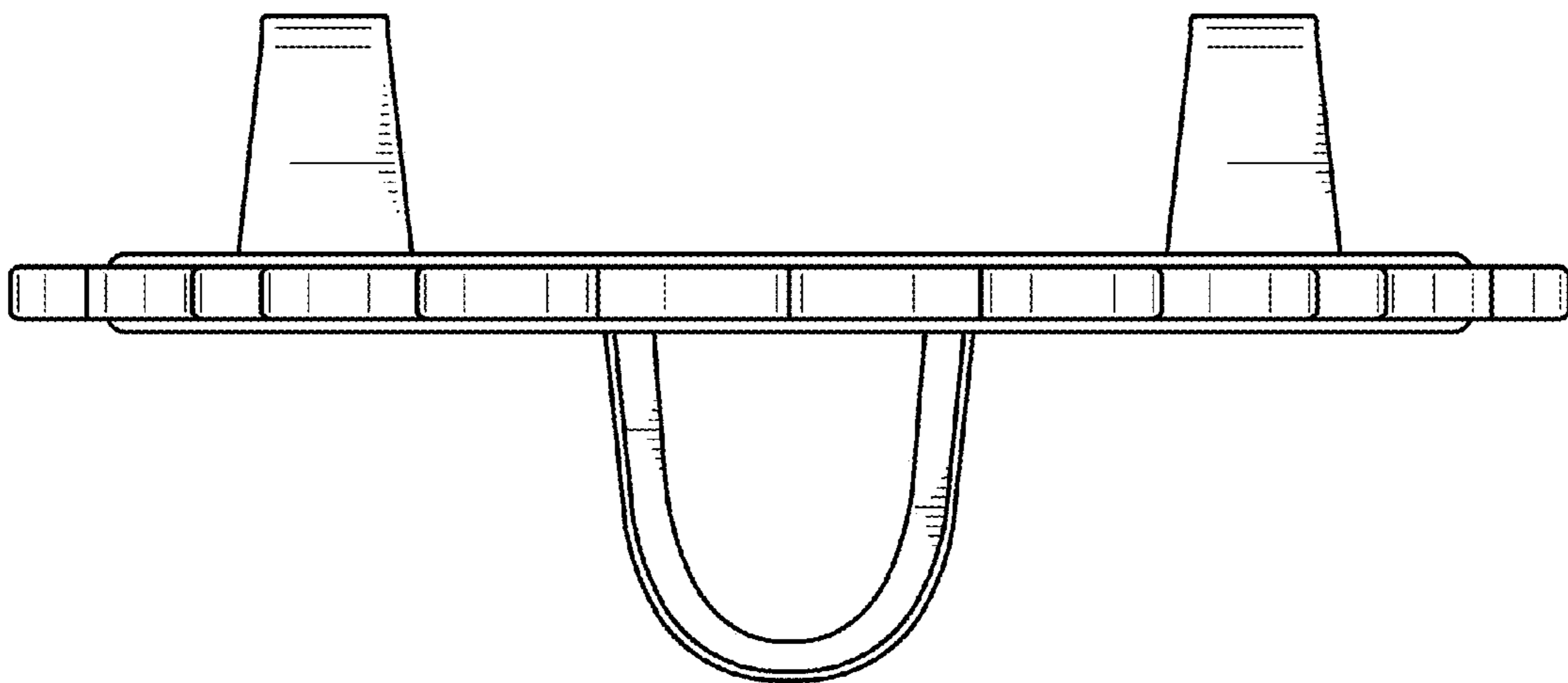

FIG. 6

