



US00D758735S

(12) **United States Design Patent**  
**Hernandez**

(10) **Patent No.:** **US D758,735 S**  
(45) **Date of Patent:** **\*\* Jun. 14, 2016**

- (54) **TAMPON HOLDER**
- (71) Applicant: **Marlene Hernandez**, Rosemead, CA (US)
- (72) Inventor: **Marlene Hernandez**, Rosemead, CA (US)
- (\*\*) Term: **15 Years**
- (21) Appl. No.: **29/542,572**
- (22) Filed: **Oct. 15, 2015**

6,039,175 A	3/2000	Wright
D427,424 S	7/2000	Conway
D432,784 S	10/2000	Conway
6,446,688 B1	9/2002	Sutton
6,481,576 B1	11/2002	Watkins
8,251,113 B2	8/2012	Baxter
2002/0153074 A1	10/2002	Chen et al.
2006/0266663 A1	11/2006	Rhea
2007/0090014 A1	4/2007	Wheeler et al.
2011/0215025 A1	9/2011	Gonzales
2013/0062246 A1	3/2013	Staples
2013/0074997 A1	3/2013	Jones et al.

*Primary Examiner* — Holly Baynham  
(74) *Attorney, Agent, or Firm* — Kenneth H. Ohriner; Perkins Coie LLP

**Related U.S. Application Data**

- (63) Continuation of application No. 14/564,902, filed on Dec. 9, 2014, now Pat. No. 9,186,284.
- (51) **LOC (10) Cl.** ..... **03-01**
- (52) **U.S. Cl.**  
USPC ..... **D3/319**
- (58) **Field of Classification Search**  
USPC ..... D3/232, 319, 245–246  
CPC ..... A45C 15/00; A45C 1/06  
See application file for complete search history.

(57) **CLAIM**

The ornamental design for a tampon holder, as shown and described.

**DESCRIPTION**

FIG. 1 is a top, front and left side perspective view showing tampons in the holder for purpose of explanation of use  
 FIG. 2 is the same view as in FIG. 1 but without showing the tampons.  
 FIG. 3 is a top view of the design shown in FIG. 2.  
 FIG. 4 is a rear view.  
 FIG. 5 is a front view.  
 FIG. 6 is a left side view.  
 FIG. 7 is a right side view; and,  
 FIG. 8 is a bottom view.  
 The broken lines showing tampons are for the purposes of illustrating environment and form no part of the claimed design.

(56) **References Cited**

**U.S. PATENT DOCUMENTS**

2,612,199 A	9/1952	Schocket
2,764,201 A	9/1956	Whippo
2,843,170 A	7/1958	Frankfurt
4,286,639 A	9/1981	Murphy
4,960,204 A	10/1990	Young et al.
5,046,620 A	9/1991	Barabina

**1 Claim, 4 Drawing Sheets**

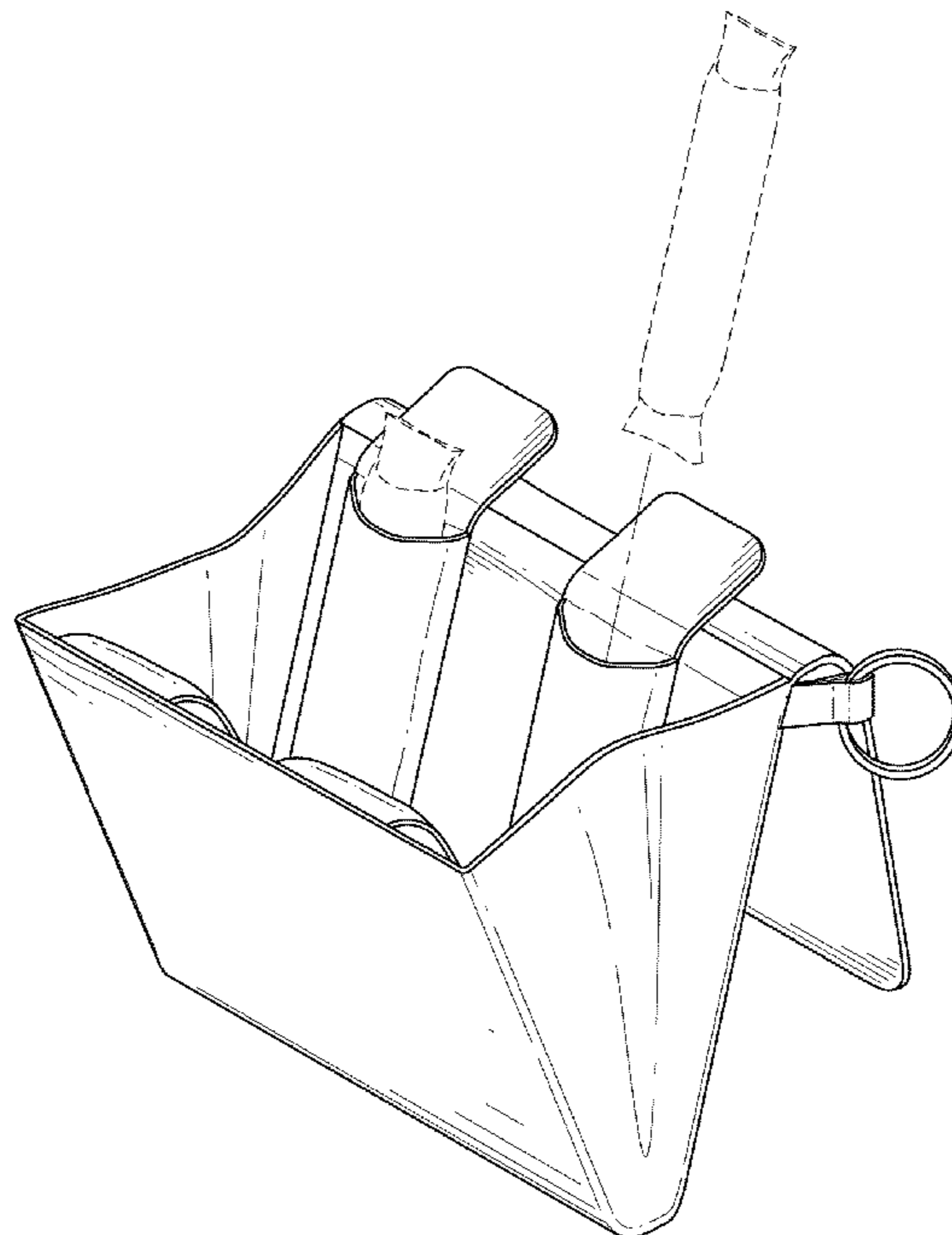

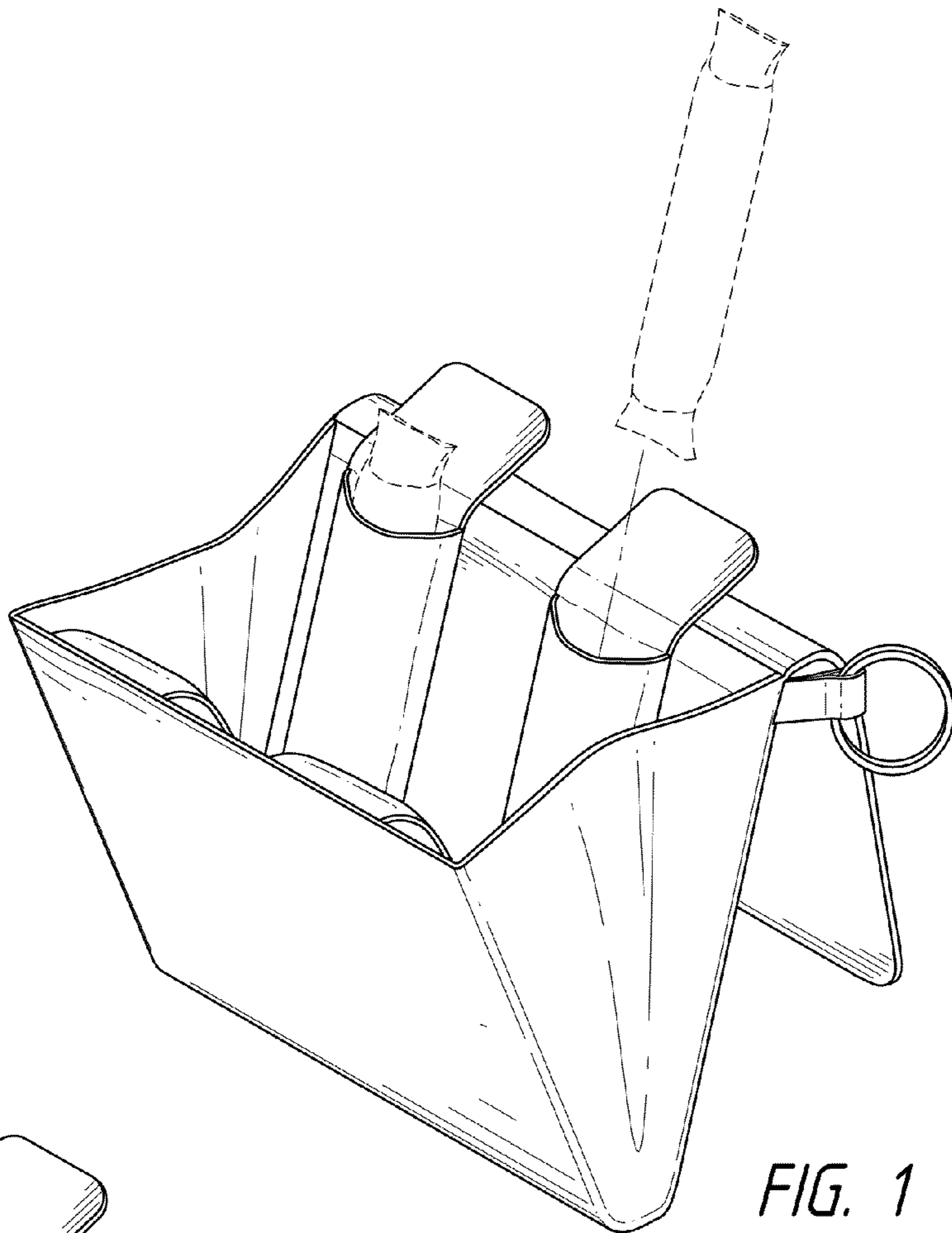

FIG. 1

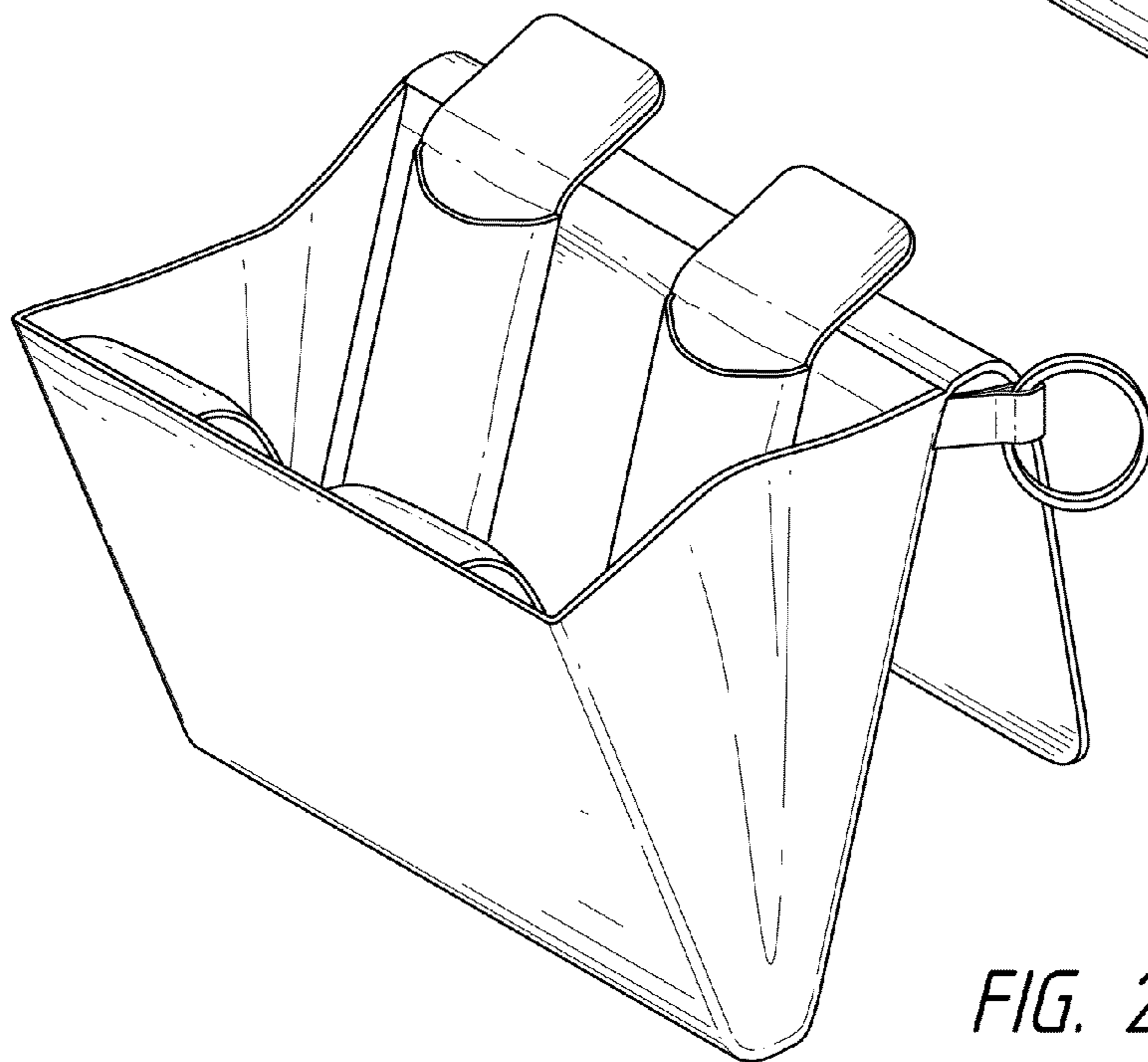
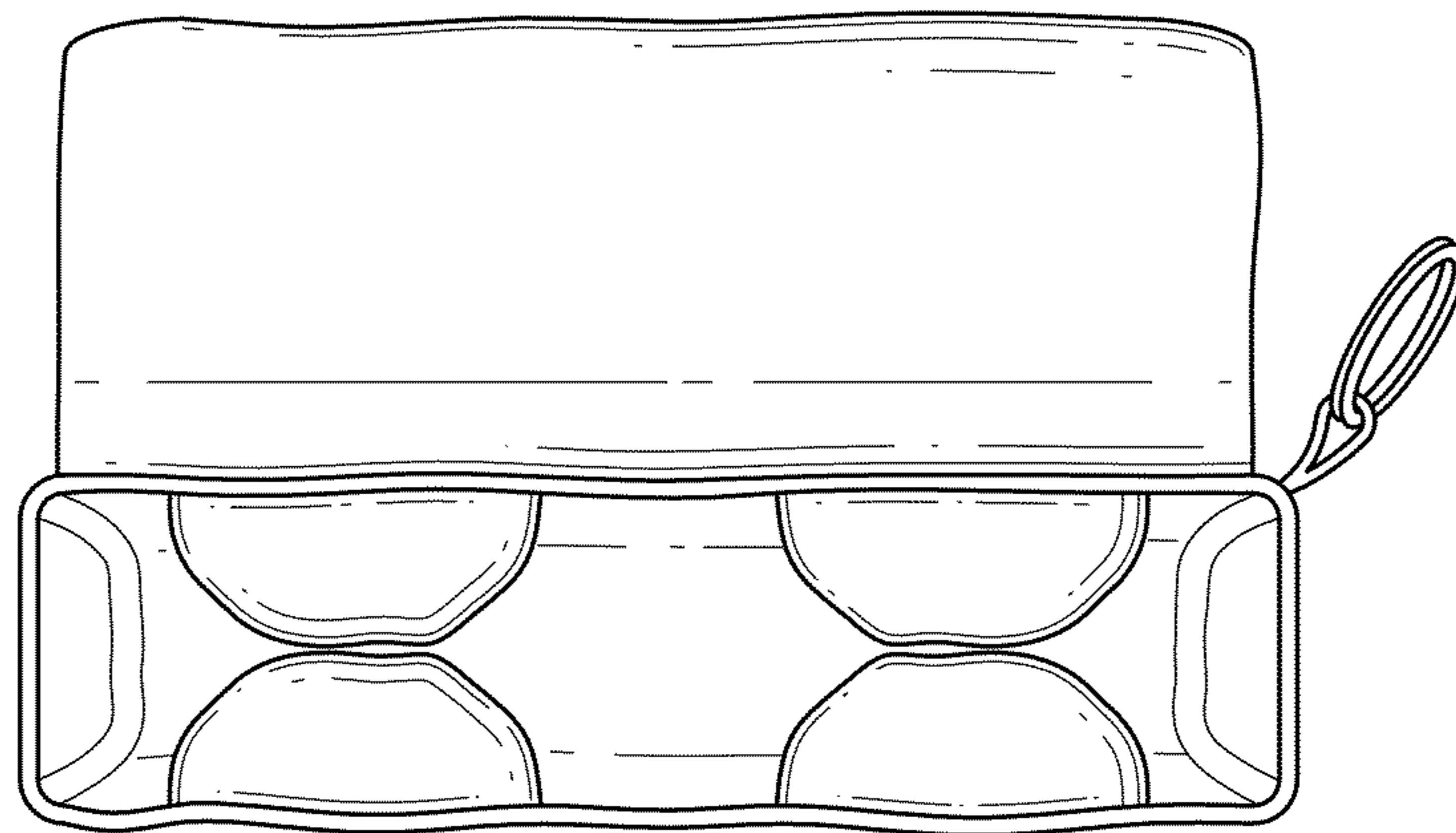
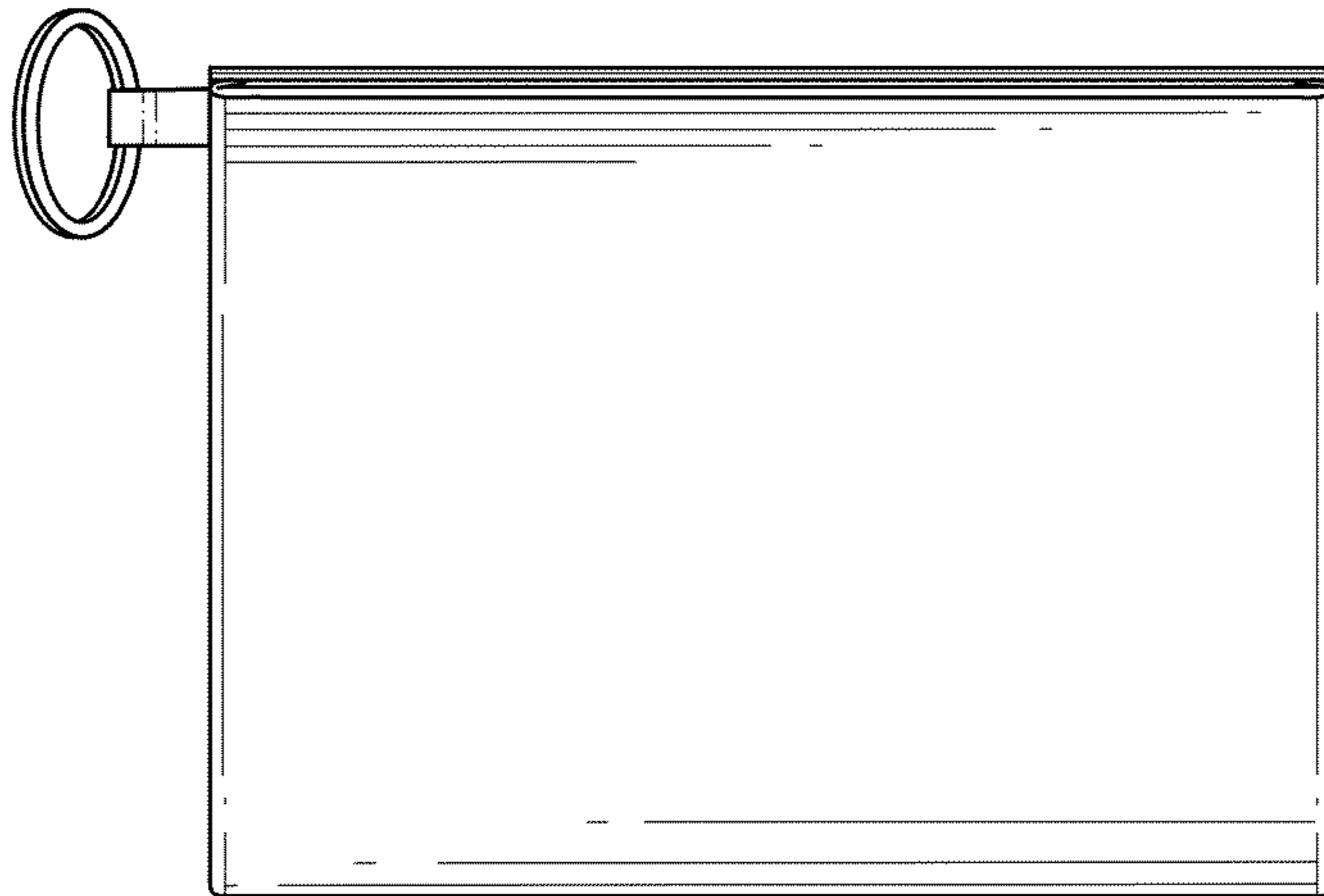

FIG. 2



*FIG. 3*



*FIG. 4*



*FIG. 5*

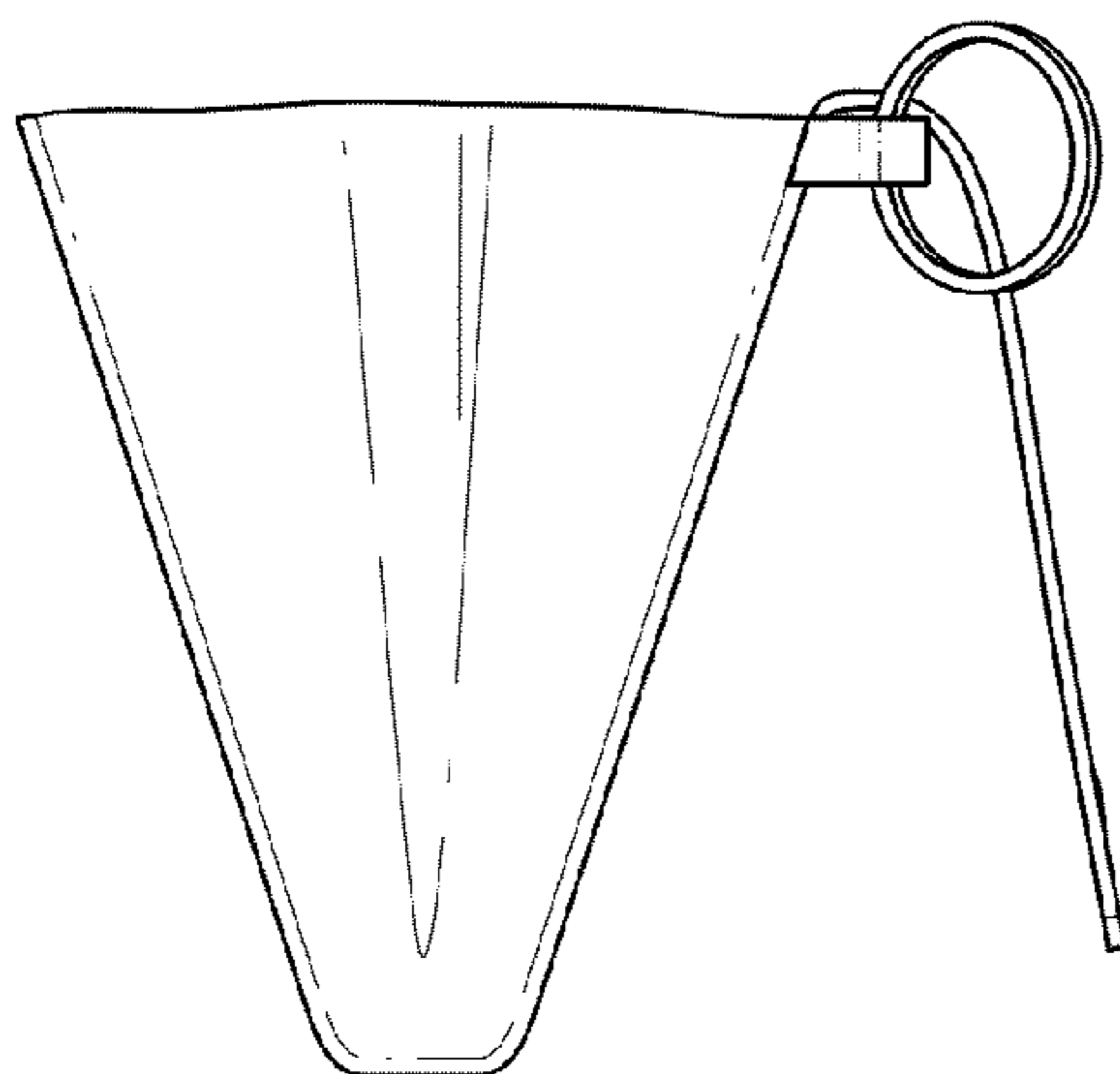

FIG. 6

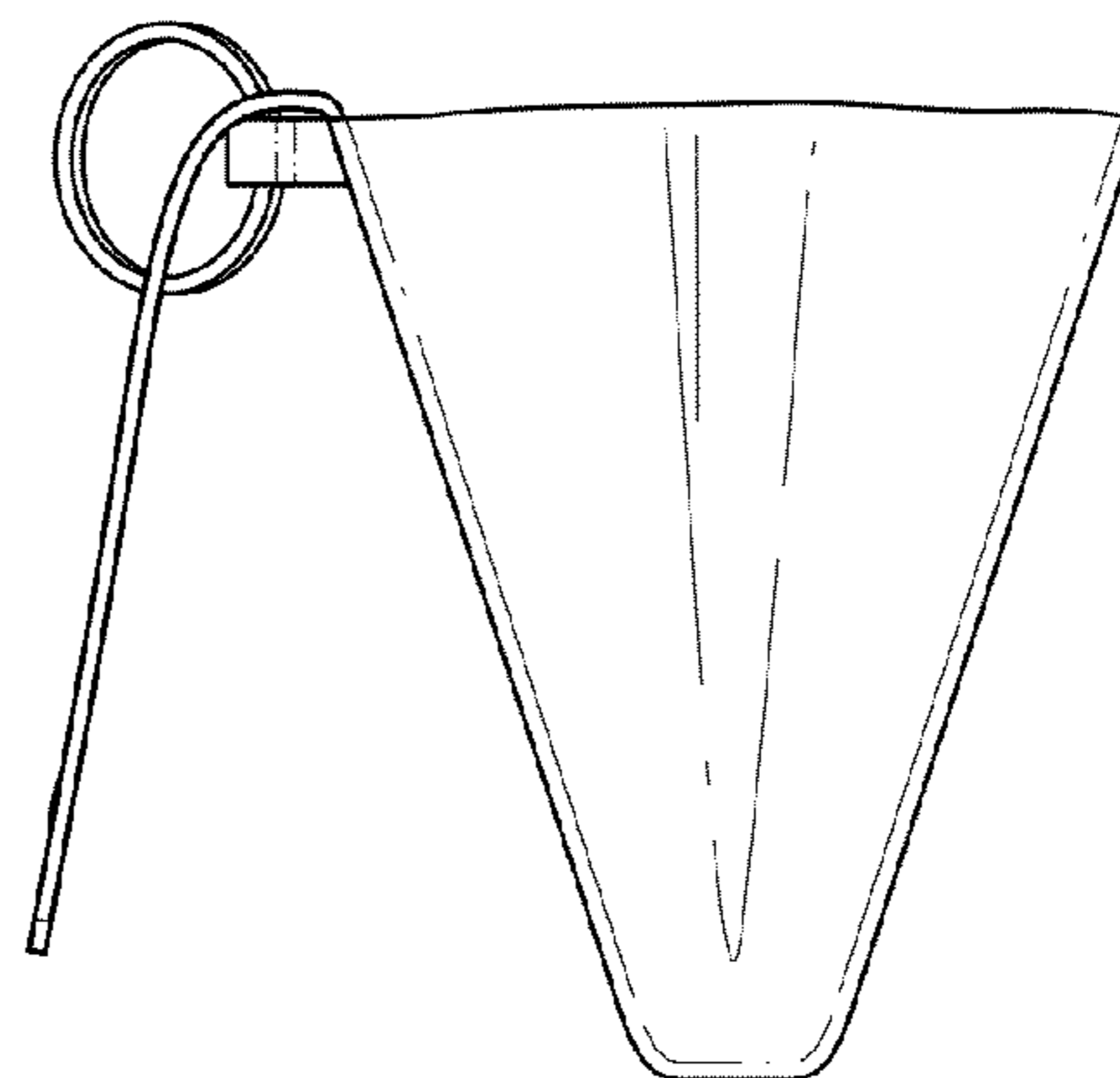

FIG. 7

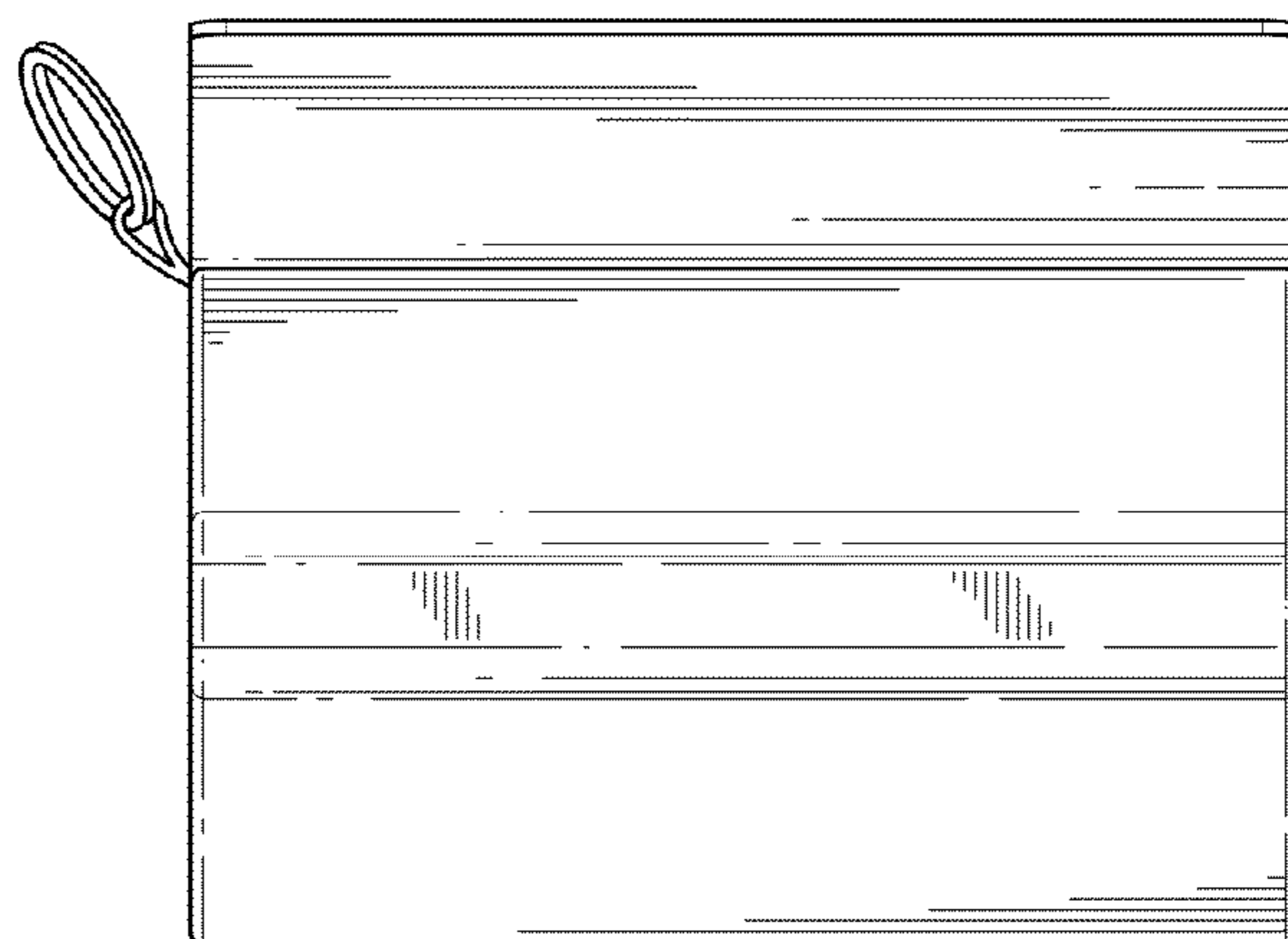

FIG. 8