



US00D758731S

(12) **United States Design Patent**
Noh

(10) **Patent No.:** **US D758,731 S**
(45) **Date of Patent:** **** Jun. 14, 2016**

- (54) **TOTE BAG**
- (71) Applicant: **BNB ENTERPRISE CORP.**,
Montebello, CA (US)
- (72) Inventor: **Kevin Kyungshik Noh**, Manhattan
Beach, CA (US)
- (73) Assignee: **BNB Enterprise Corp.**, Montebello, CA
(US)
- (**) Term: **14 Years**
- (21) Appl. No.: **29/516,624**
- (22) Filed: **Feb. 4, 2015**
- (51) **LOC (10) Cl.** **03-01**
- (52) **U.S. Cl.**
USPC **D3/304**
- (58) **Field of Classification Search**
USPC D3/304, 307, 232–233, 240–243,
D3/245–246, 318, 276, 289, 900; 150/100,
150/103–110, 113–114, 117–119
CPC A21C 1/024; A45C 3/06; A45C 3/04;
A45C 7/077
See application file for complete search history.

D467,772 S *	12/2002	Williams	D7/607
D502,599 S *	3/2005	Cabana	D3/287
D521,324 S *	5/2006	Pittaluga	D7/607
D550,459 S *	9/2007	Eskandry	D3/305
D550,963 S *	9/2007	Eskandry	D3/307
D563,105 S *	3/2008	Rothschild	D3/276
D628,800 S *	12/2010	Rees	D3/304
D655,579 S *	3/2012	Hassman	D7/607
D685,575 S *	7/2013	Cullen	D3/272
D700,435 S *	3/2014	Gold	D3/307
D711,096 S *	8/2014	Hanna	D3/232
D717,040 S *	11/2014	Swartzel	D3/232
2009/0101253 A1 *	4/2009	Kinskey	A45C 3/04 150/107

* cited by examiner

Primary Examiner — Derrick Holland
Assistant Examiner — Jennifer O King

(74) *Attorney, Agent, or Firm* — Wood, Phillips, Katz, Clark & Mortimer

(57) **CLAIM**
The ornamental design for a tote bag, substantially as shown and described.

DESCRIPTION

FIG. 1 is a perspective view of a tote bag showing my new design;
FIG. 2 is a front elevational view thereof;
FIG. 3 is a rear elevational view thereof;
FIG. 4 is a top plan view thereof;
FIG. 5 is a bottom plan view thereof;
FIG. 6 is a right side elevational view thereof; and,
FIG. 7 is a left side elevational view thereof.
The broken lines represent stitching which forms no part of the claimed design.

1 Claim, 7 Drawing Sheets

- (56) **References Cited**
U.S. PATENT DOCUMENTS
- 3,550,663 A * 12/1970 Johnston A45C 3/06
150/103
- D361,548 S * 8/1995 Bascom D12/407
- D371,051 S * 6/1996 Melk D7/607
- 5,794,747 A * 8/1998 Bryant A45C 3/00
190/18 R
- D397,871 S * 9/1998 Bellechilli D3/303

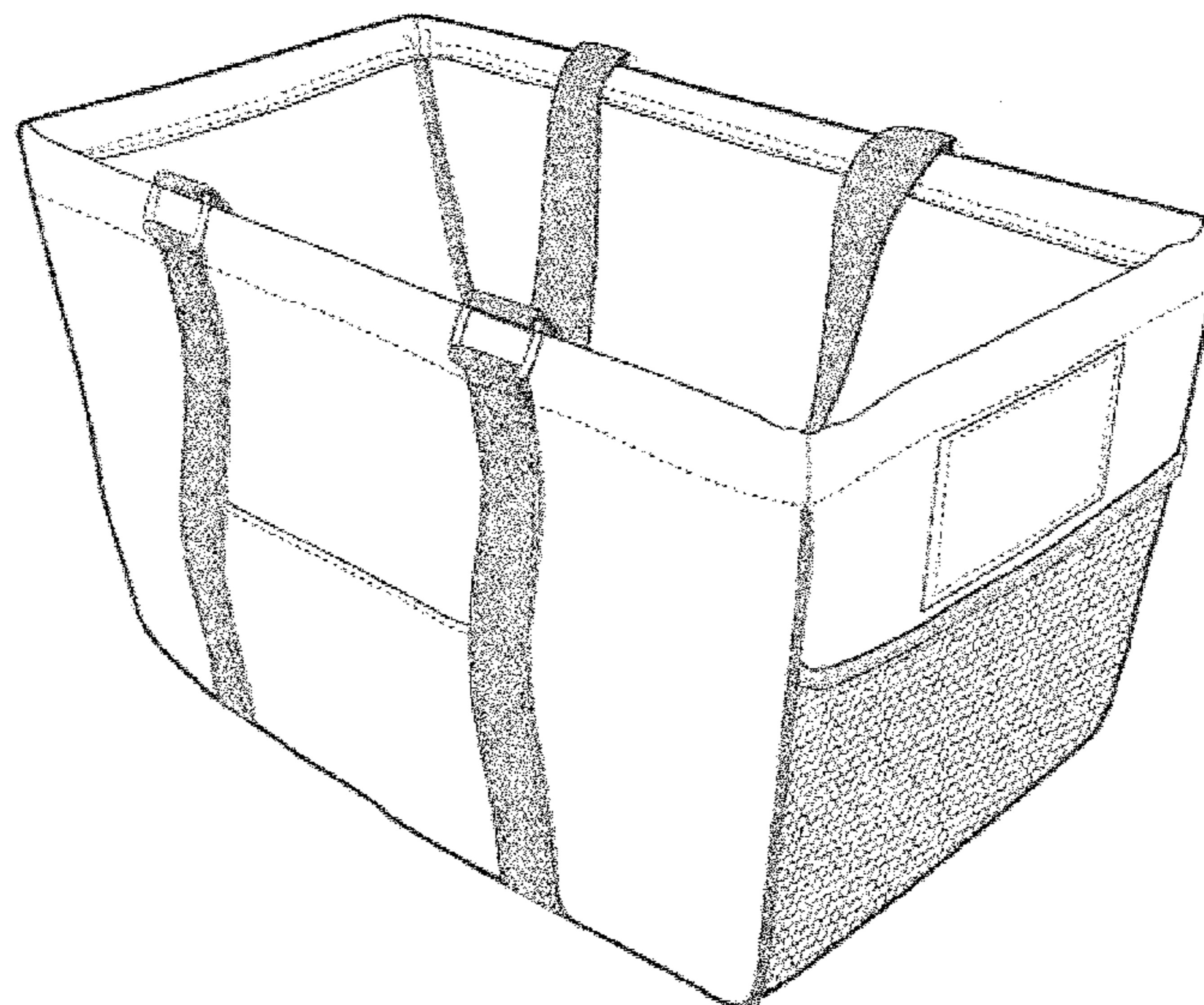

FIG.1

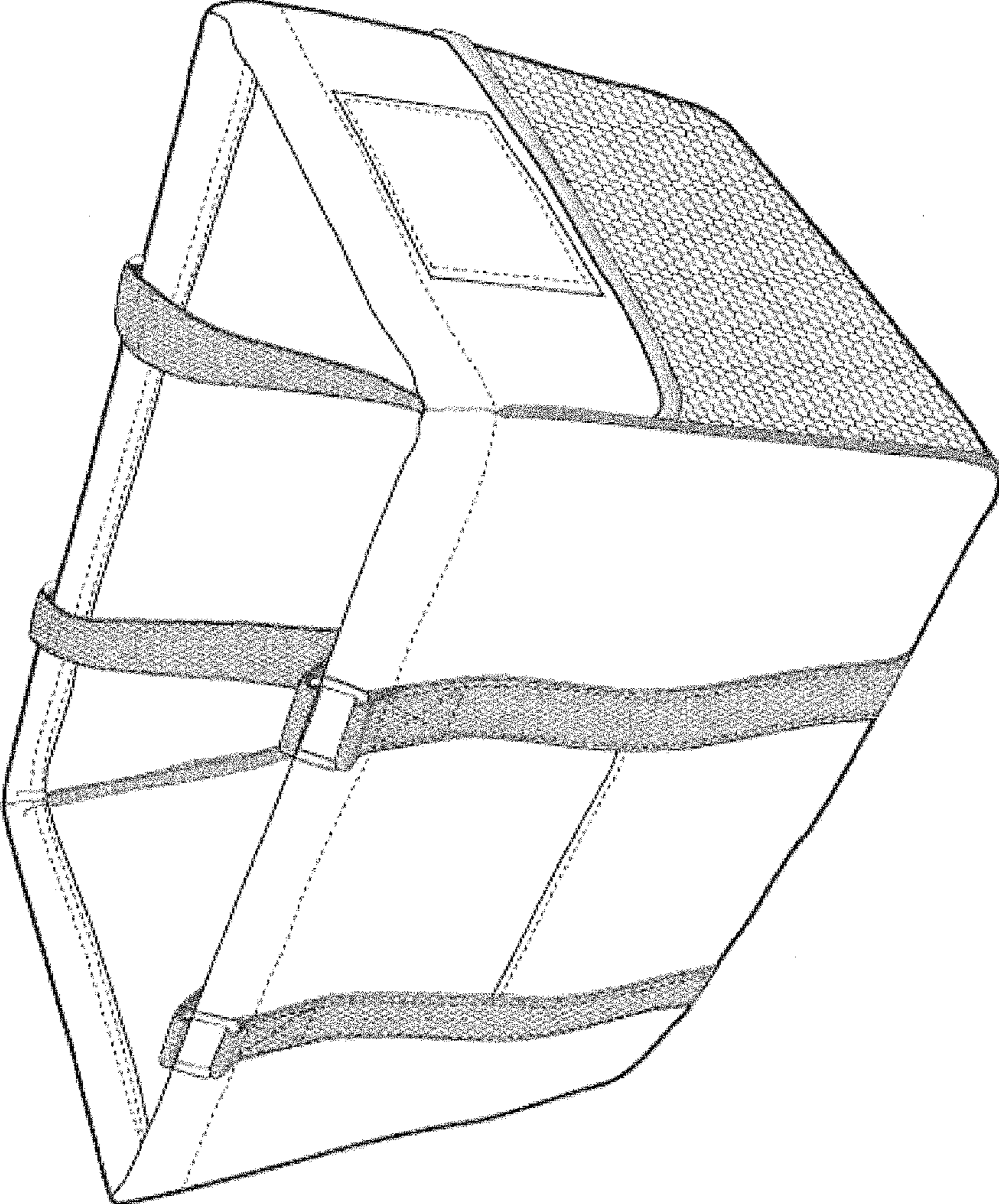

FIG. 2

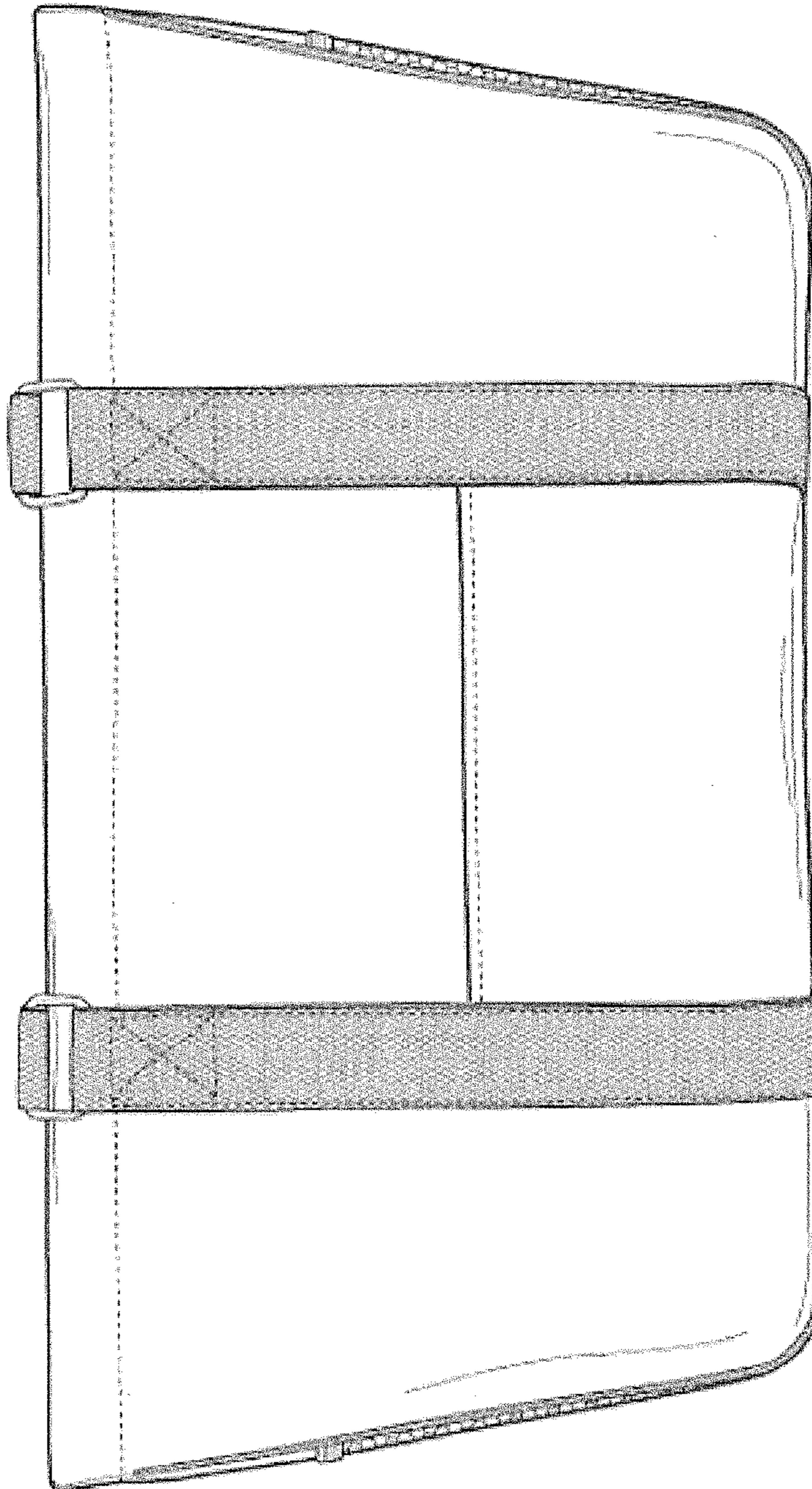

FIG. 3

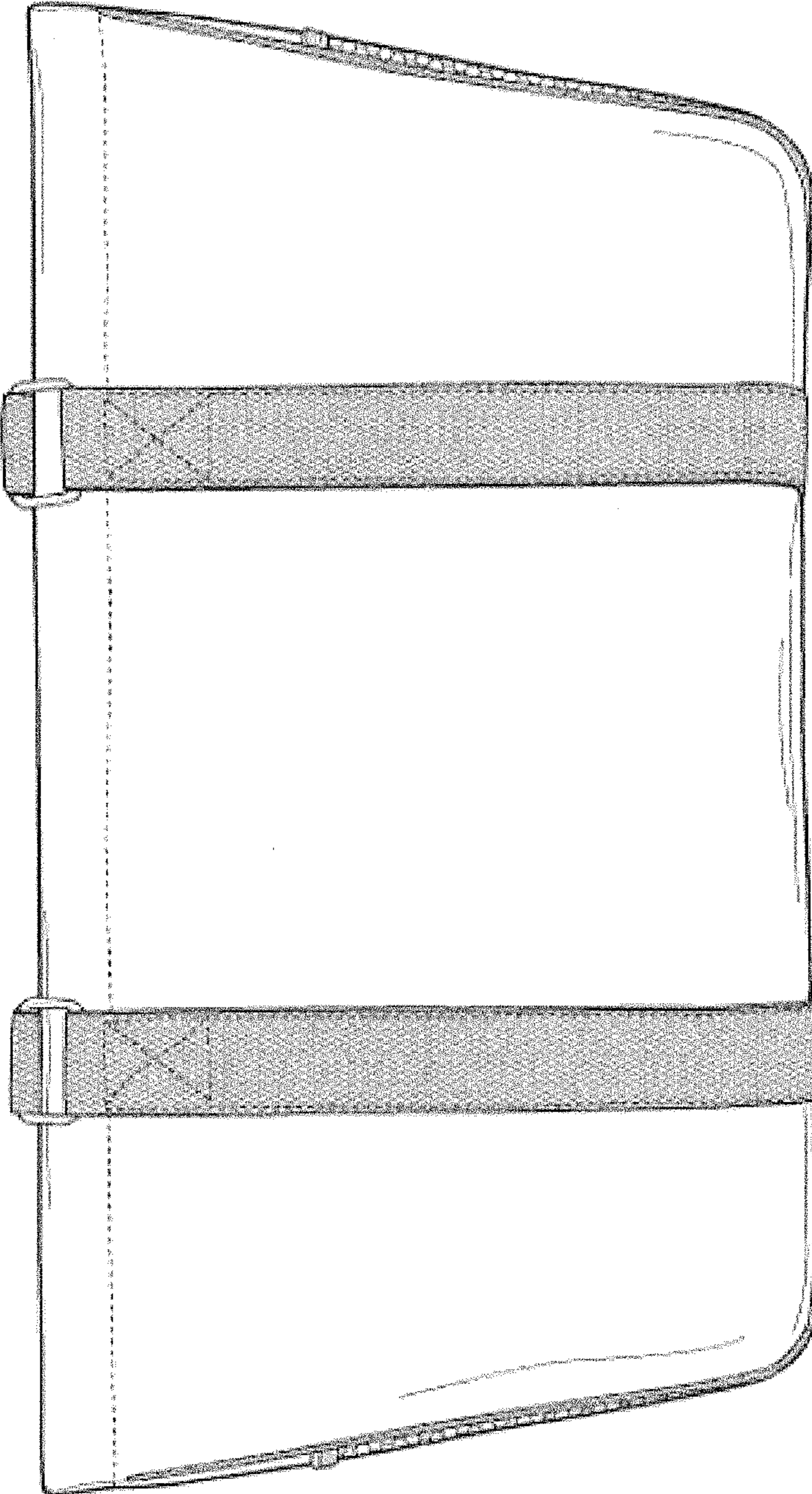

FIG.4

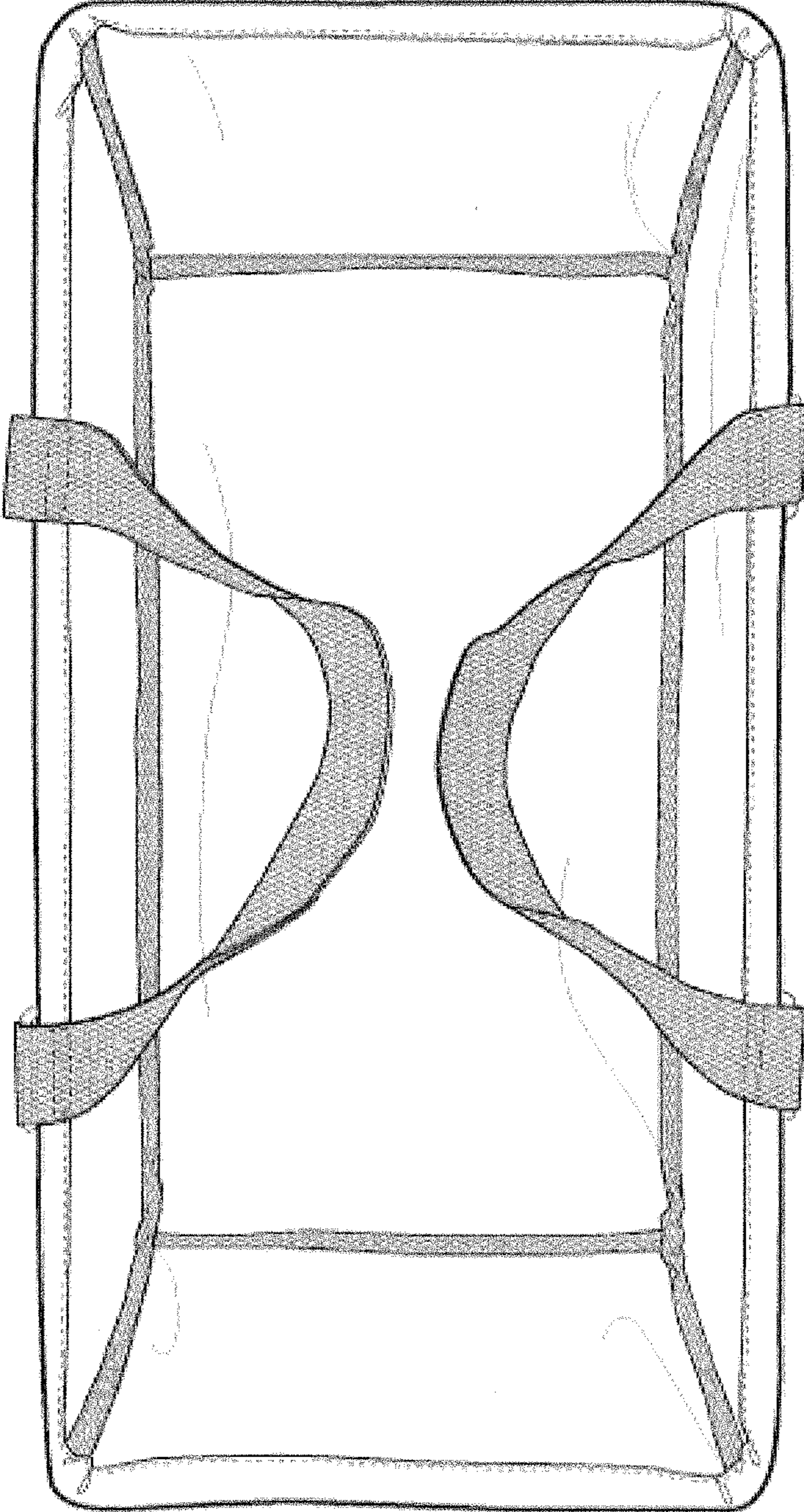

FIG. 5

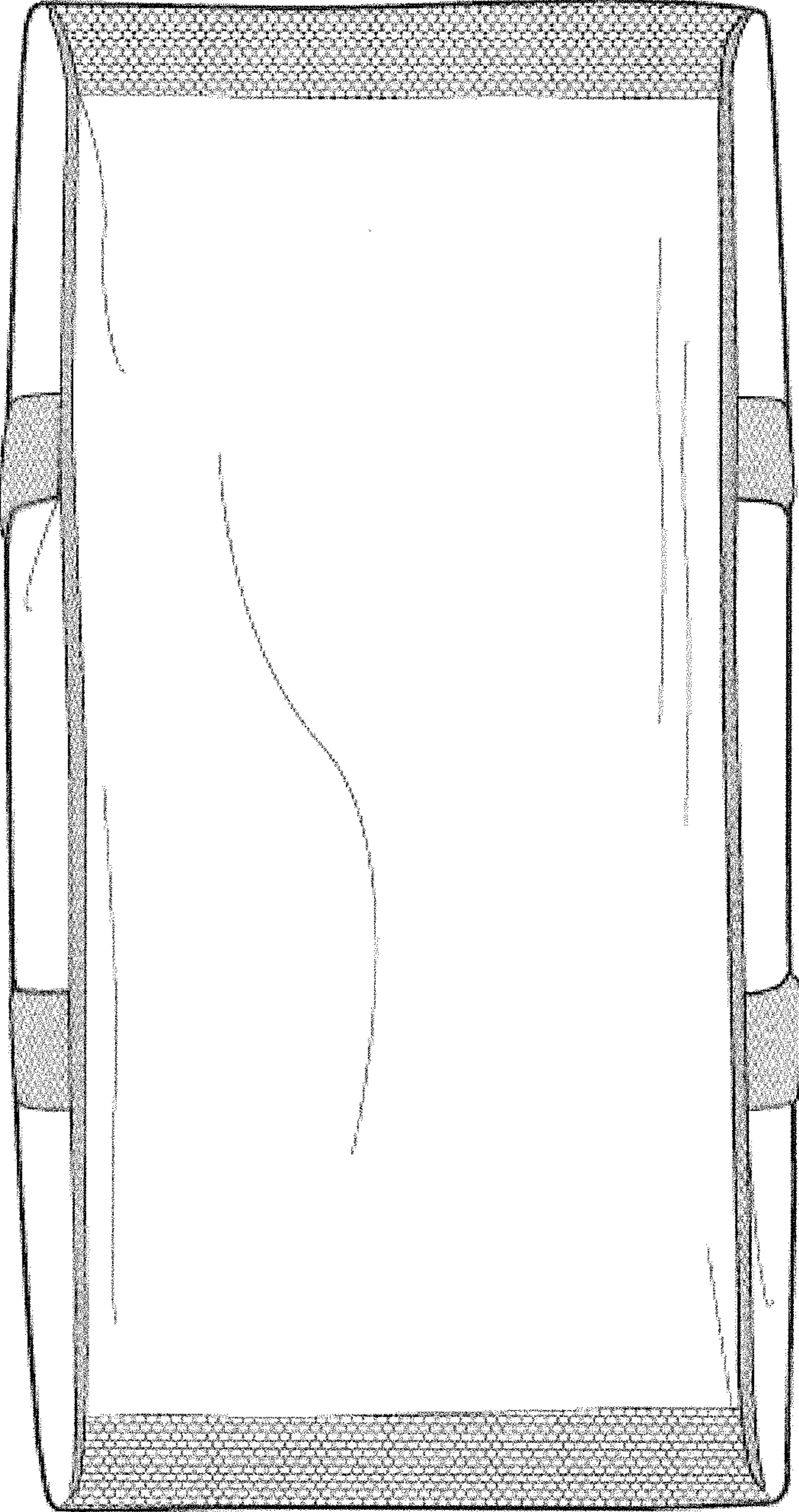

FIG. 6

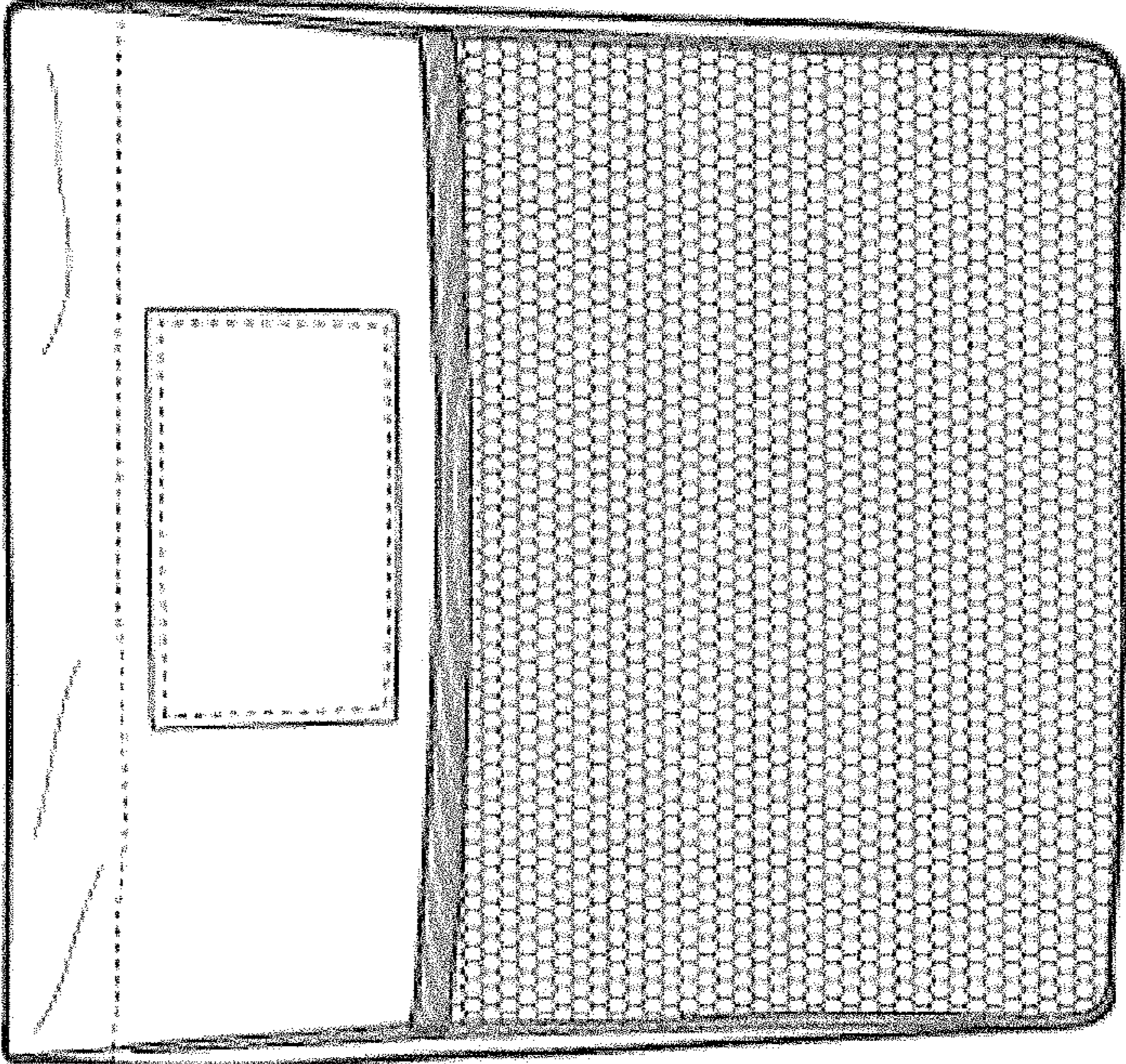

FIG. 7

