



US00D758712S

(12) **United States Design Patent**
Ladegast et al.

(10) **Patent No.:** **US D758,712 S**
(45) **Date of Patent:** **** Jun. 14, 2016**

(54) **PORTABLE MEDICATION COOLING
DEVICE**

(71) Applicants: **Raymond O. Ladegast**, Rockford, MI
(US); **Janet L. Ladegast**, Rockford, MI
(US)

(72) Inventors: **Raymond O. Ladegast**, Rockford, MI
(US); **Janet L. Ladegast**, Rockford, MI
(US)

(**) Term: **14 Years**

(21) Appl. No.: **29/489,022**

(22) Filed: **Apr. 25, 2014**

Related U.S. Application Data

(63) Continuation-in-part of application No. 12/897,501,
filed on Oct. 4, 2010, now abandoned.

(51) **LOC (10) Cl.** **03-01**

(52) **U.S. Cl.**
USPC **D3/203.1**

(58) **Field of Classification Search**
USPC D3/201-205, 272-273; 206/364,
206/569-571; 220/23.89, 212.5, 592.15,
220/902, 919; 62/371, 457.1, 592.03,
62/592.08; D7/605; D9/737-738
See application file for complete search history.

(56) **References Cited**

U.S. PATENT DOCUMENTS

3,713,302 A 1/1973 Reviel
3,730,374 A * 5/1973 Picciano B65D 77/0493
220/23.89

(Continued)

Primary Examiner — Catheri Oliver-Garcia

(74) *Attorney, Agent, or Firm* — Robert C Montgomery;
Montgomery Patent & Design LP

(57) **CLAIM**

The ornamental design for a portable medication cooling device, as shown and described.

DESCRIPTION

FIG. 1 is a top perspective view of a portable medication cooling device showing a lid portion and a container portion in assemblage;

FIG. 2 is an exploded view of a portable medication cooling device, showing the lid portion, the container portion and the freezable tube portion;

FIG. 3 is a top perspective view of the lid portion;

FIG. 4 is an bottom perspective view of FIG. 3;

FIG. 5 is a front view of FIG. 3;

FIG. 6 is a rear view of FIG. 3;

FIG. 7 is a left-hand side view of FIG. 3;

FIG. 8 is a right-hand side view of FIG. 3;

FIG. 9 is a top view of FIG. 3;

FIG. 10 is a bottom view of FIG. 3;

FIG. 11 is a cross-sectional view taken along line 11-11 in FIG. 5;

FIG. 12 is a cross-sectional view taken along line 12-12 in FIG. 6;

FIG. 13 is a top perspective view of the freezable tube;

FIG. 14 is a bottom perspective view of FIG. 13;

FIG. 15 is a front view of FIG. 13, wherein a rear view is a mirror image of the front view;

FIG. 16 is a left-hand side view of FIG. 13, wherein a right-hand side view is a mirror image of the left-hand side view;

FIG. 17 is a top view of FIG. 13;

FIG. 18 is a bottom view of FIG. 13;

FIG. 19 is a cross-sectional view taken along line 19-19 in FIG. 15, wherein a cross-section of the rear, right-hand side, and left-hand side views are mirror image of the cross section of the front view;

FIG. 20 is a top perspective view of the container;

FIG. 21 is a front view of FIG. 20, wherein a rear view is a mirror image of the front view;

FIG. 22 is a left-hand side view of FIG. 20, wherein a right-hand side view is a mirror image of the left-hand side view;

FIG. 23 is a top view of FIG. 20;

FIG. 24 is a bottom view of FIG. 20;

FIG. 25 is a cross-sectional view taken along line 25-25 in FIG. 21; and,

FIG. 26 is a cross-sectional view taken along line 26-26 in FIG. 22.

1 Claim, 24 Drawing Sheets

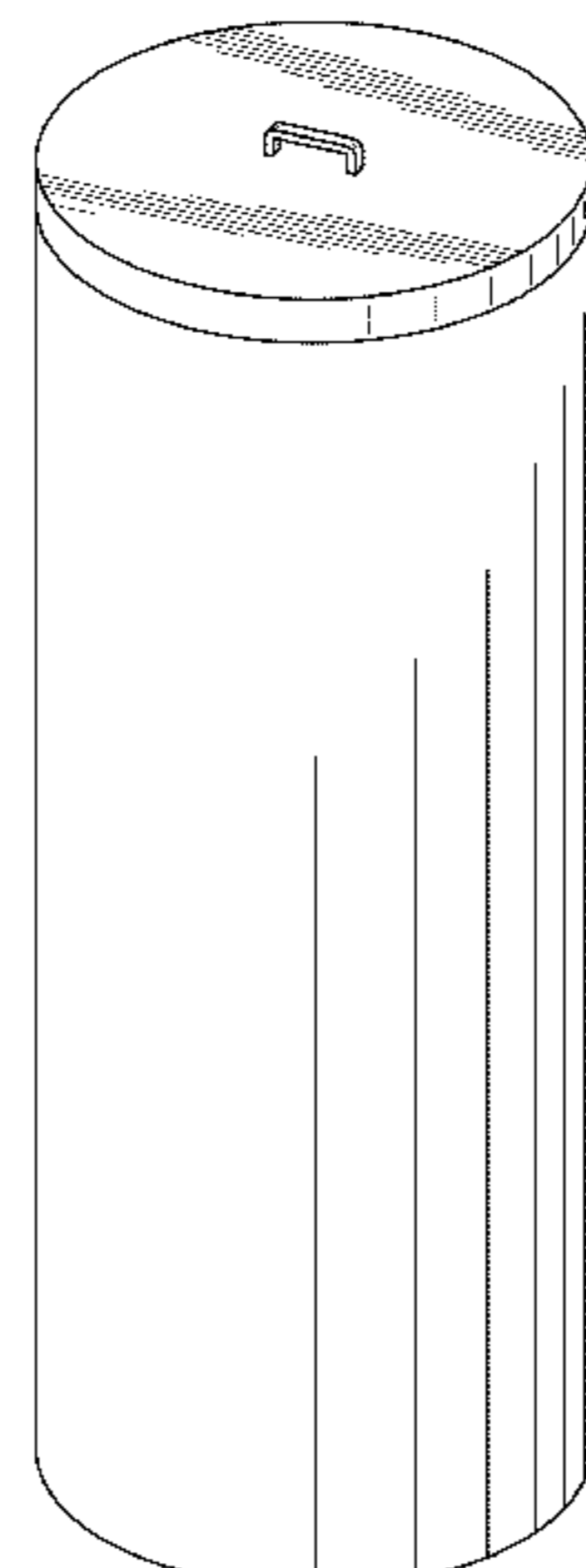

(56)

References Cited

U.S. PATENT DOCUMENTS

4,429,793 A 2/1984 Ehmann
 4,446,970 A 5/1984 Fürther
 D315,249 S * 3/1991 Tilson D3/203.1
 5,181,394 A * 1/1993 Schea, III A61J 1/165
 116/219
 5,186,900 A * 2/1993 Jensen A61B 10/007
 206/569
 5,356,426 A 10/1994 Delk et al.
 5,600,958 A * 2/1997 Henning B01L 9/00
 62/372
 5,865,032 A * 2/1999 MacPherson A61J 1/165
 62/3.62

5,934,099 A * 8/1999 Cook A61J 1/165
 206/570
 5,956,968 A 9/1999 Grabowski
 D484,304 S * 12/2003 Sanderson D3/203.1
 6,959,814 B1 11/2005 Hyman
 7,107,783 B2 * 9/2006 Smolko A41D 13/0053
 62/315
 7,597,196 B2 * 10/2009 Langone A61M 5/002
 206/364
 D633,712 S * 3/2011 Everette D3/203.1
 2003/0163182 A1 8/2003 Hickey
 2005/0016895 A1 1/2005 Glenn
 2007/0095831 A1 * 5/2007 Thatcher A45F 3/16
 220/212.5

* cited by examiner

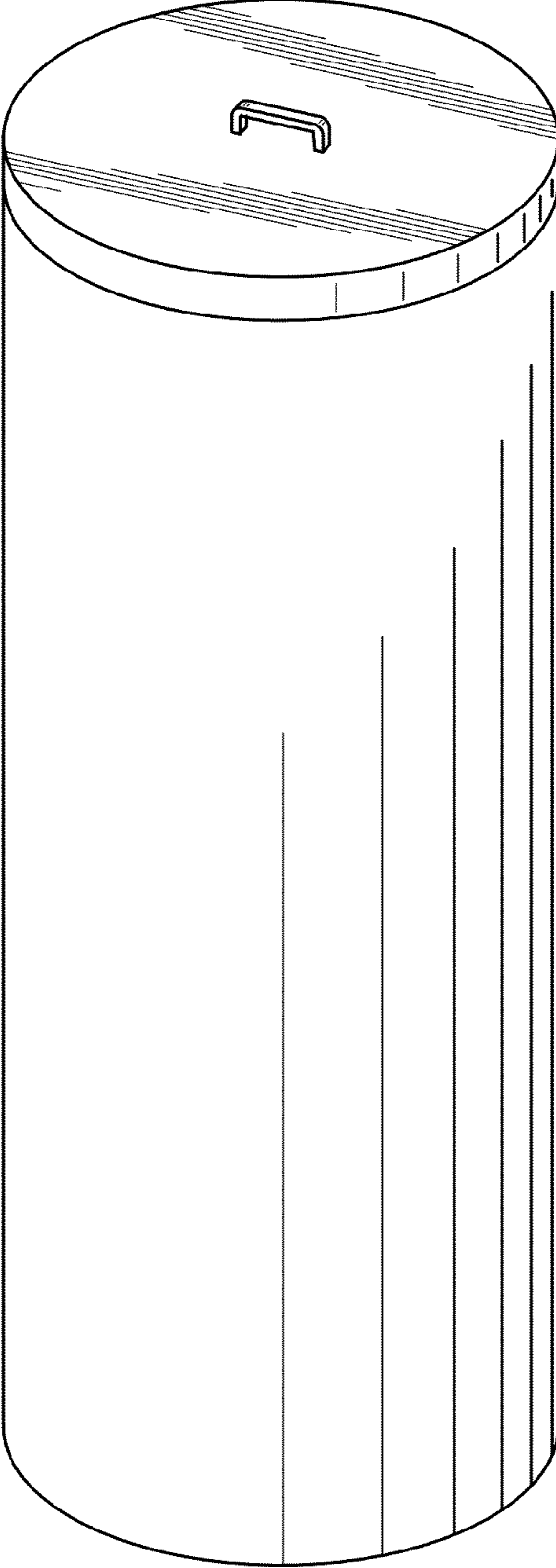

FIG. 1

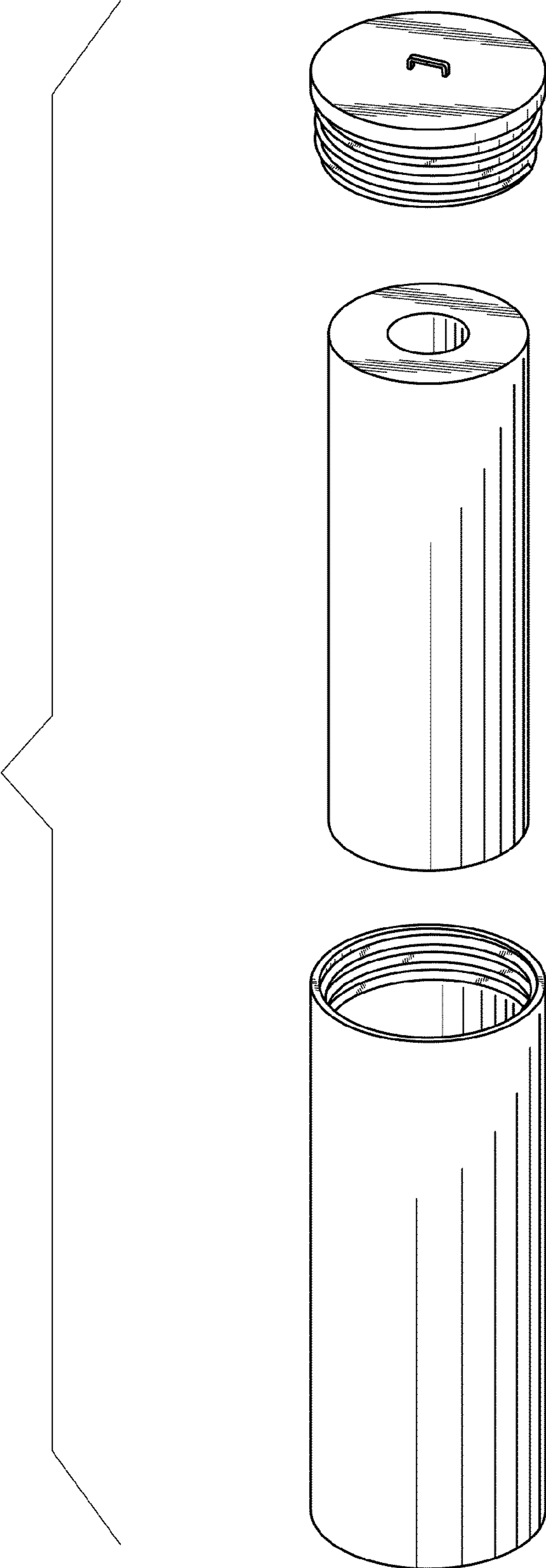

FIG. 2

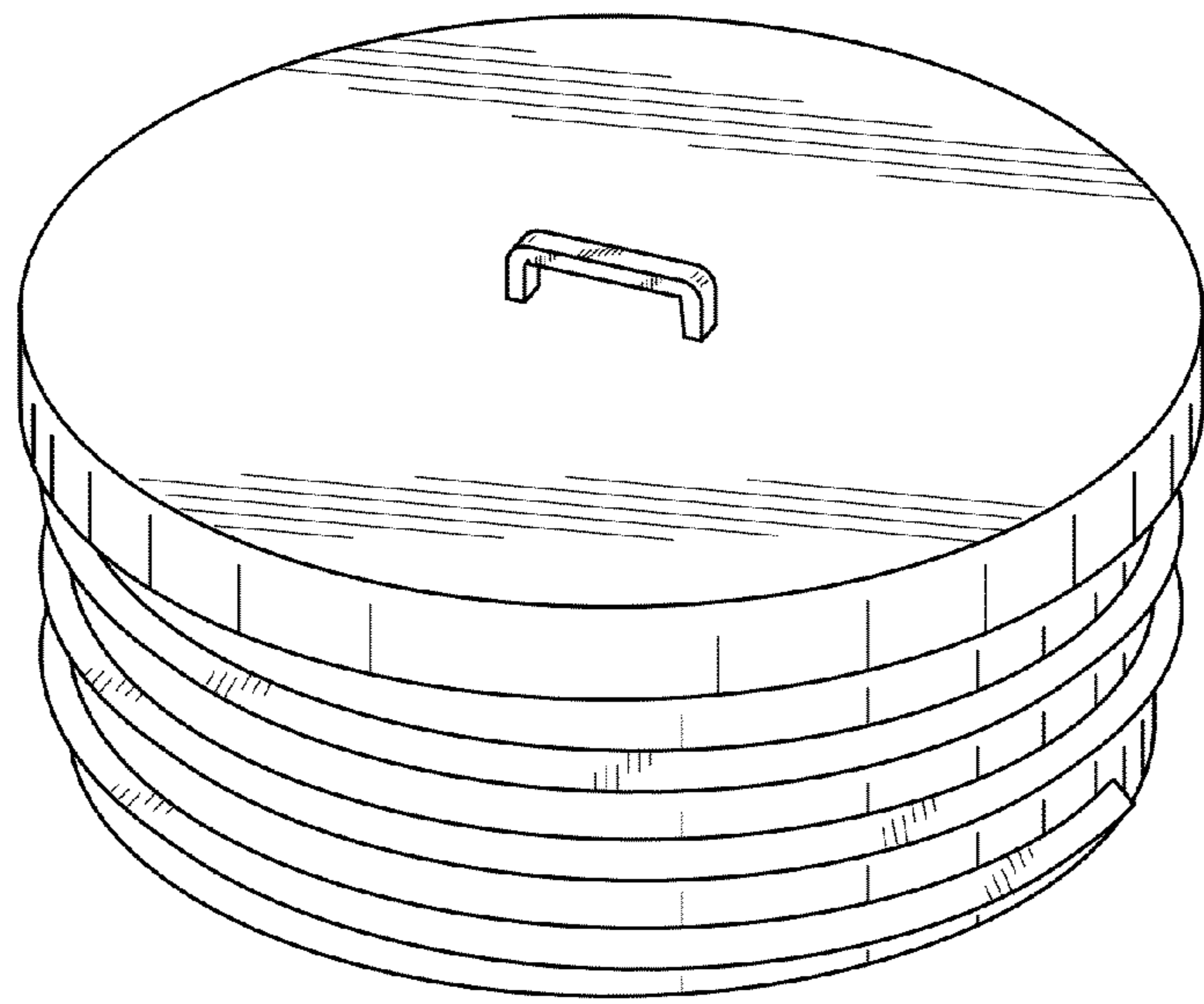

FIG. 3

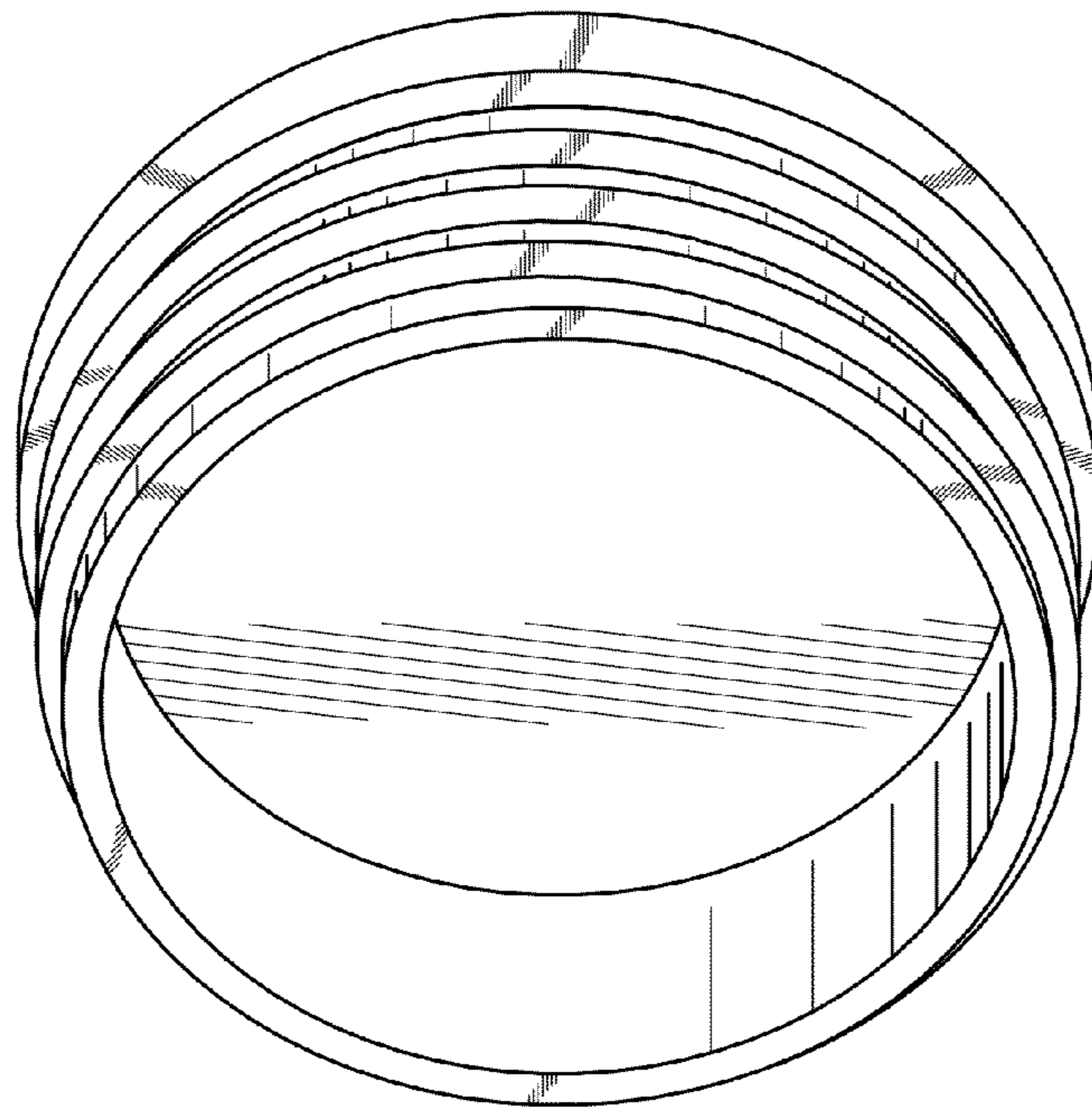

FIG. 4

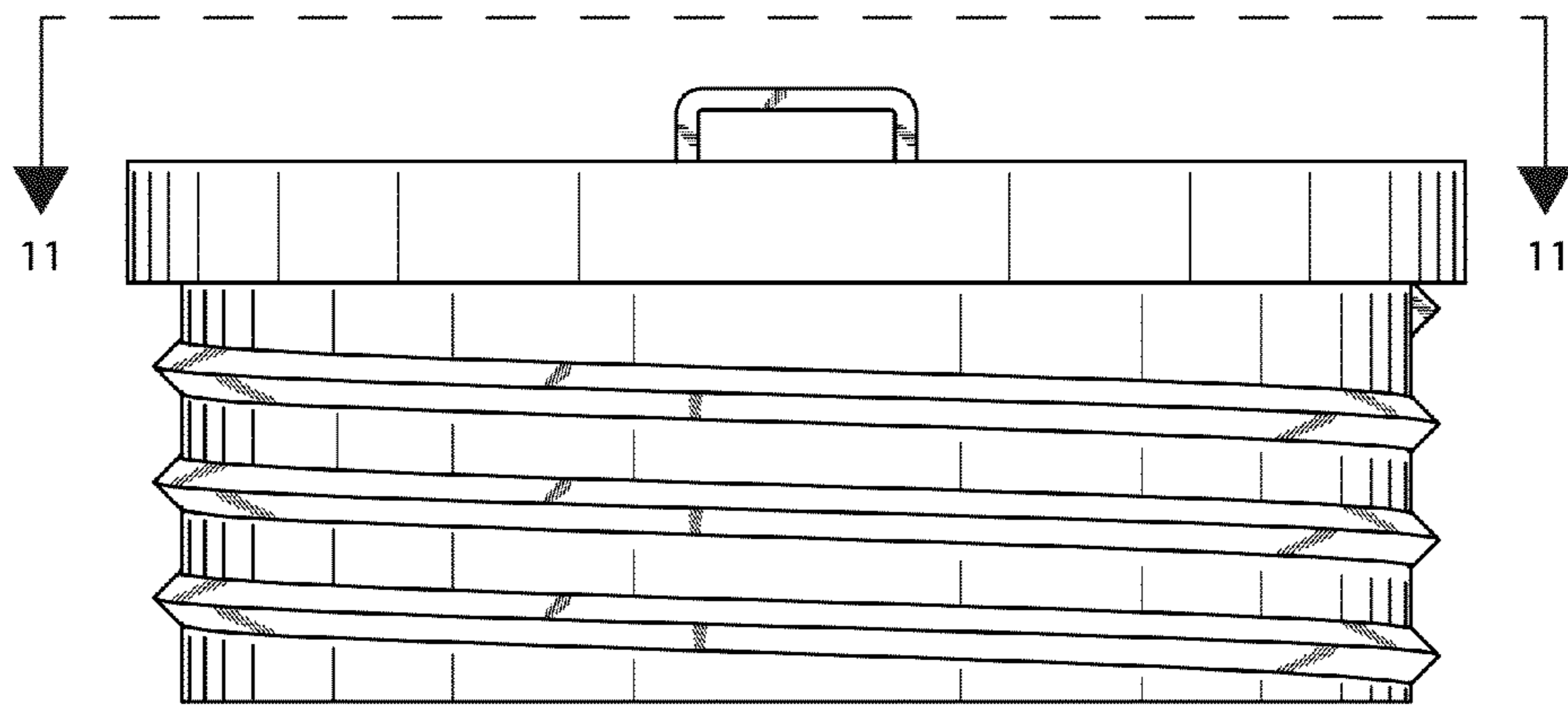

FIG. 5

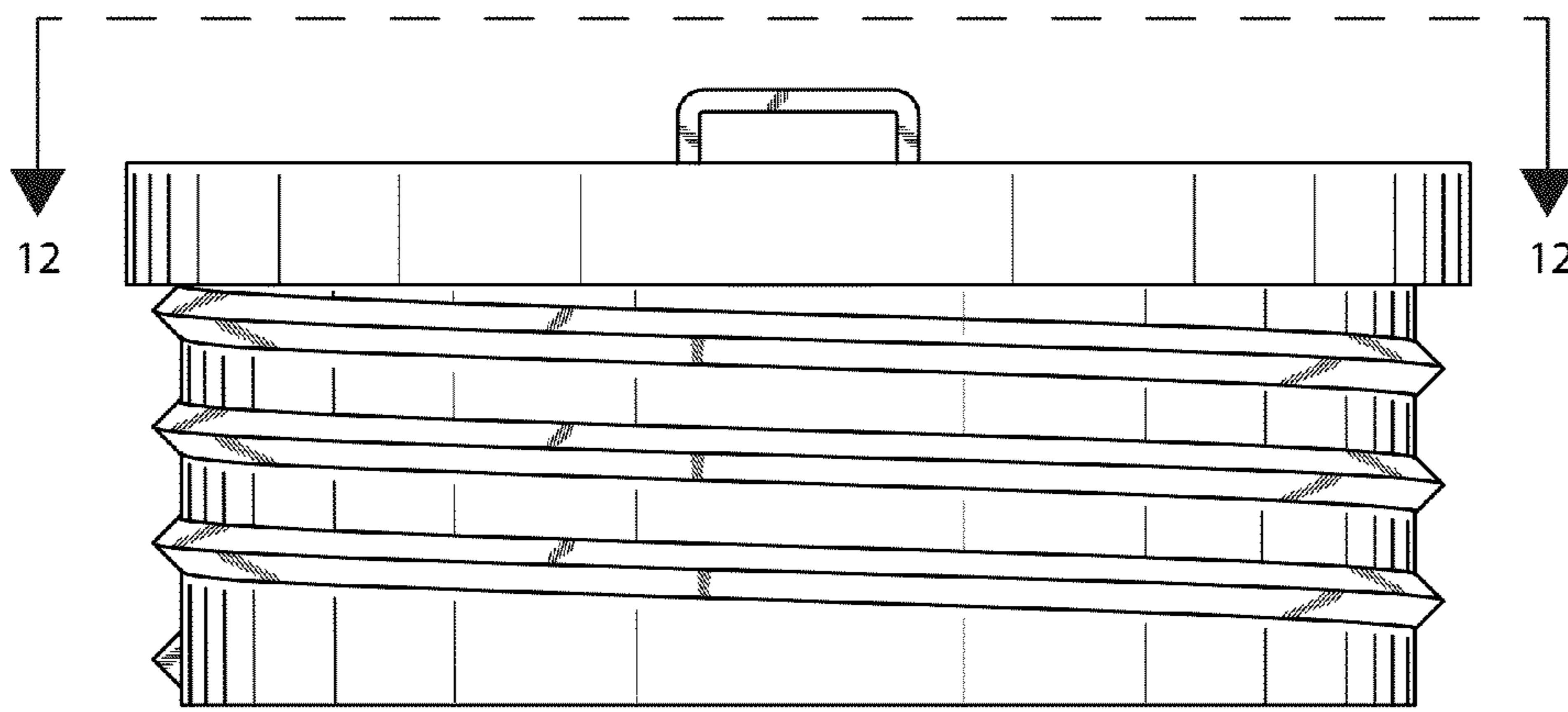

FIG. 6

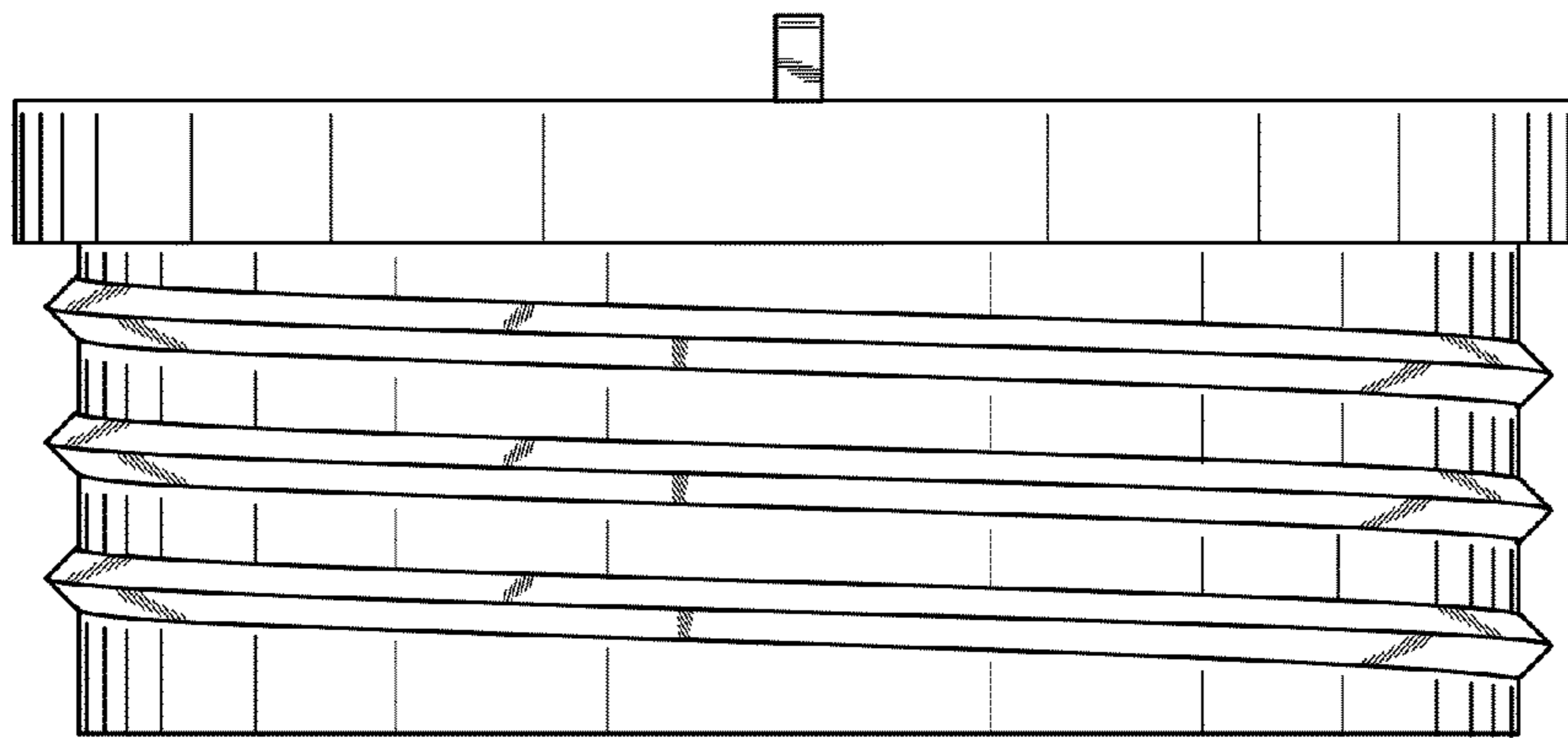

FIG. 7

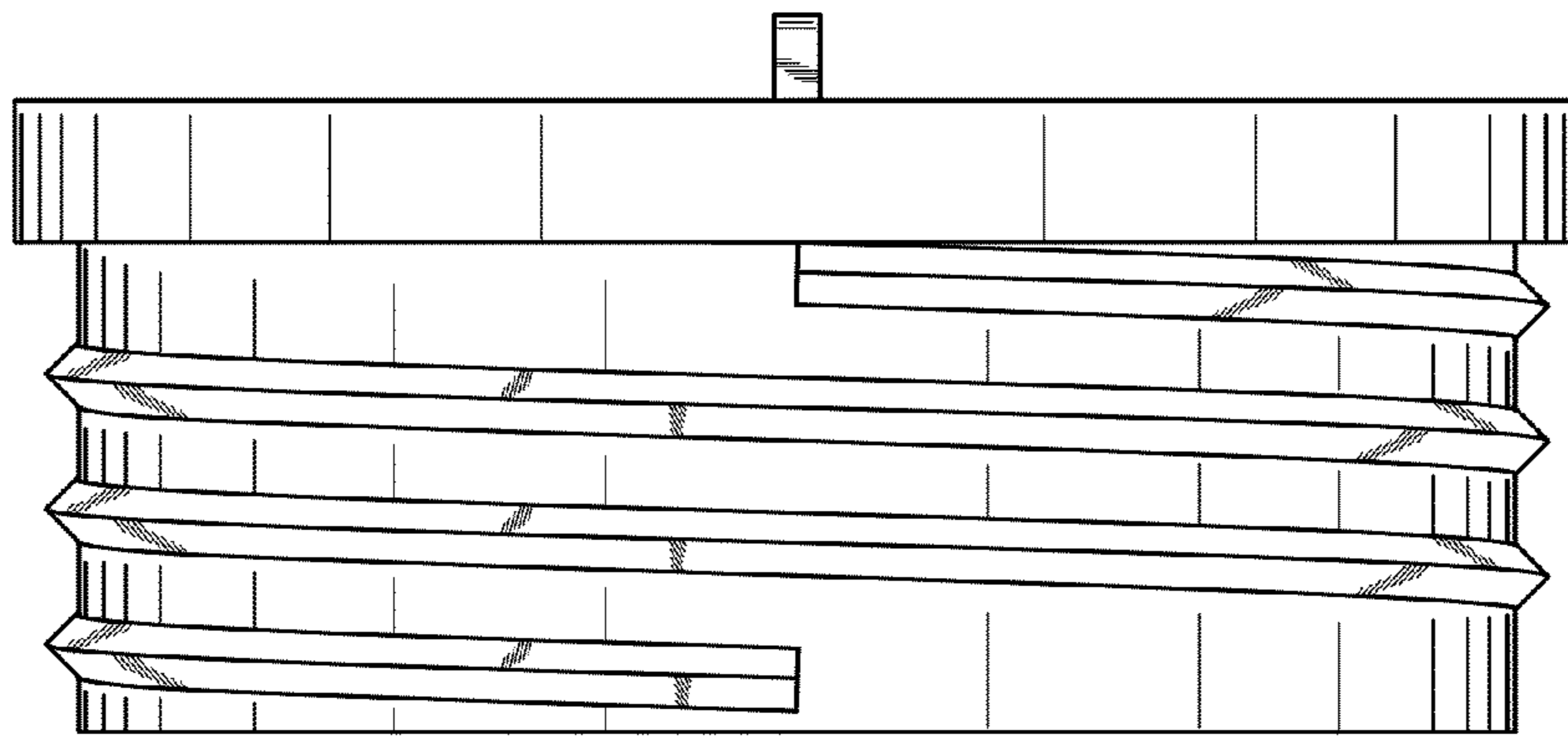

FIG. 8

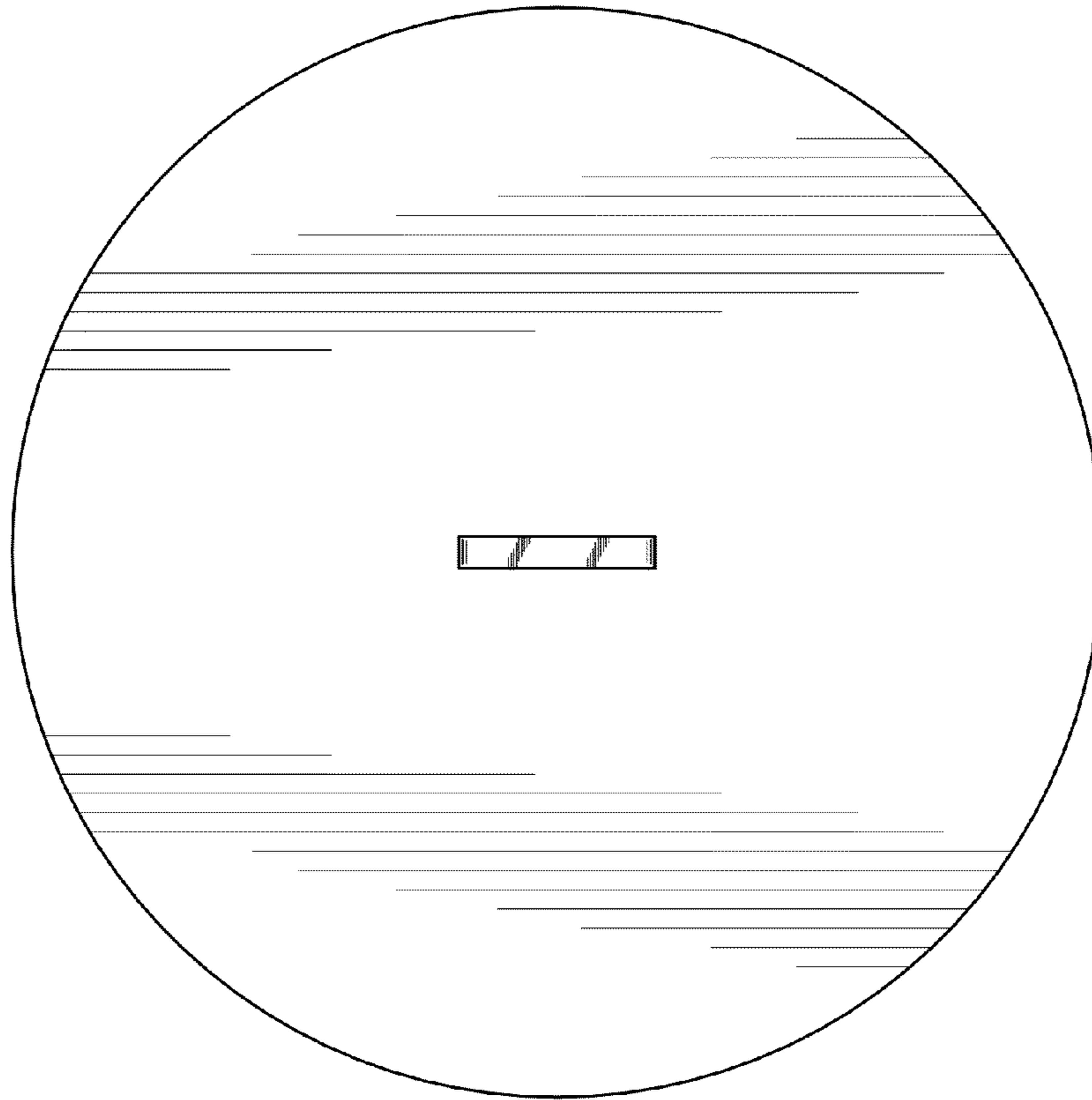

FIG. 9

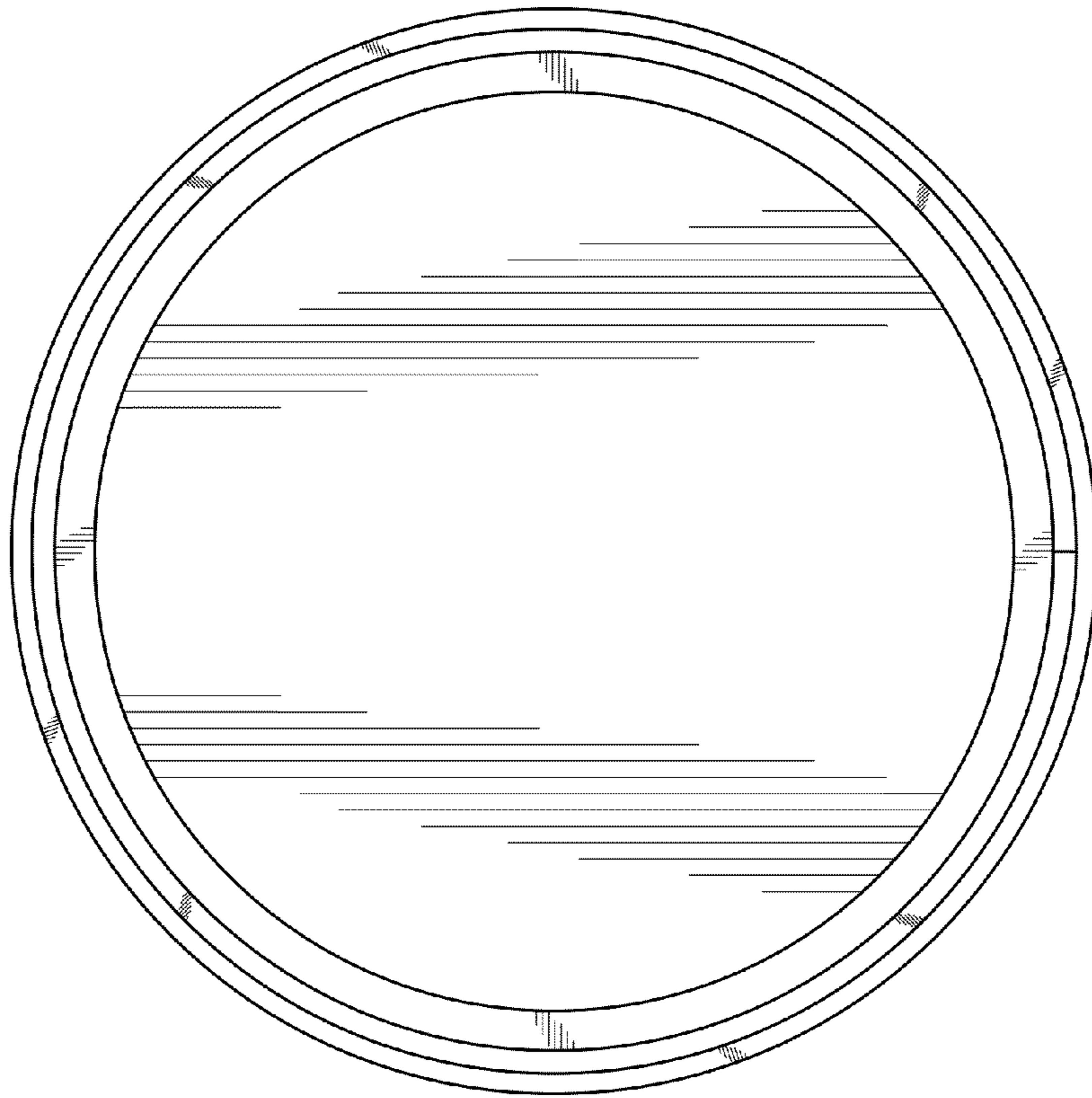

FIG. 10

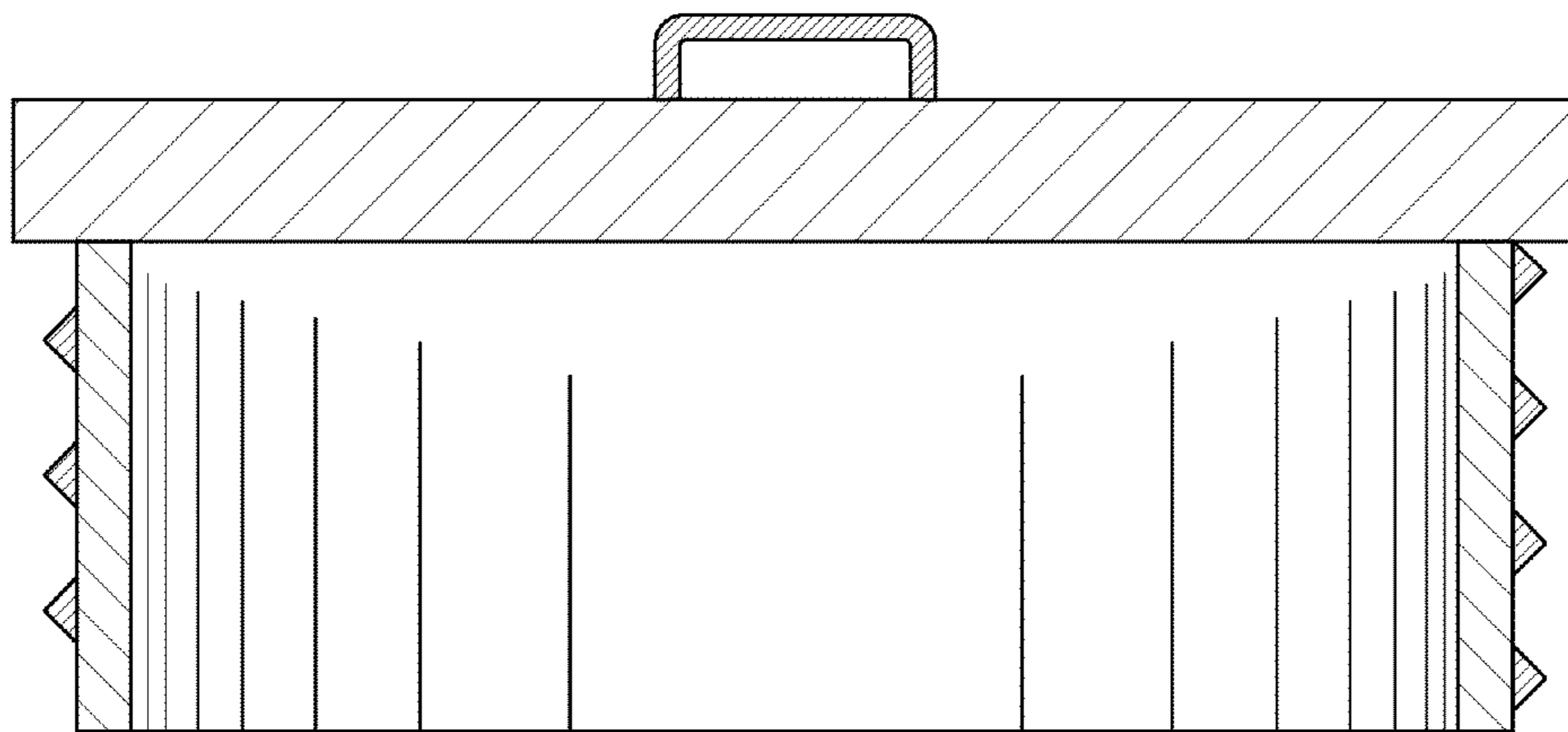

FIG. 11

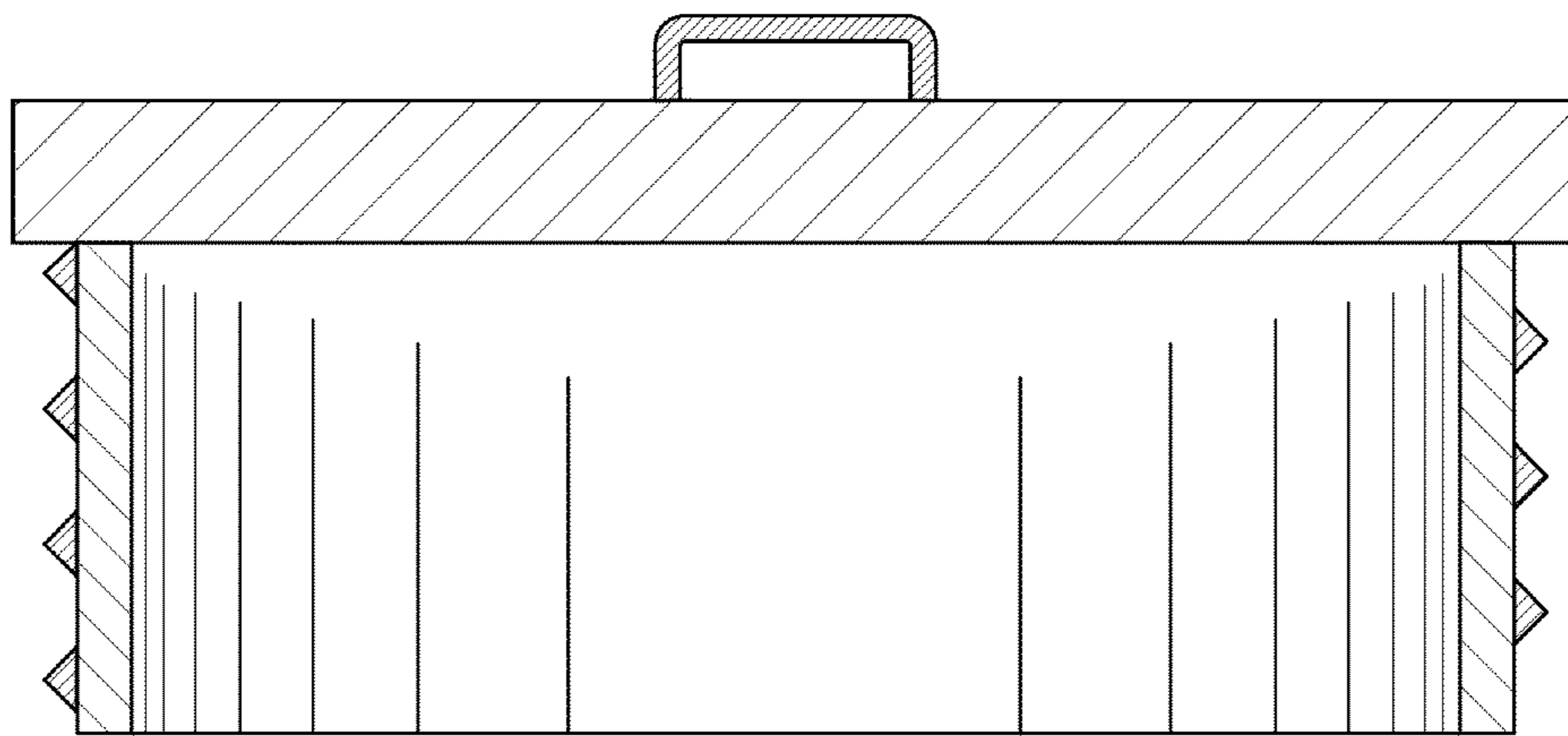

FIG. 12

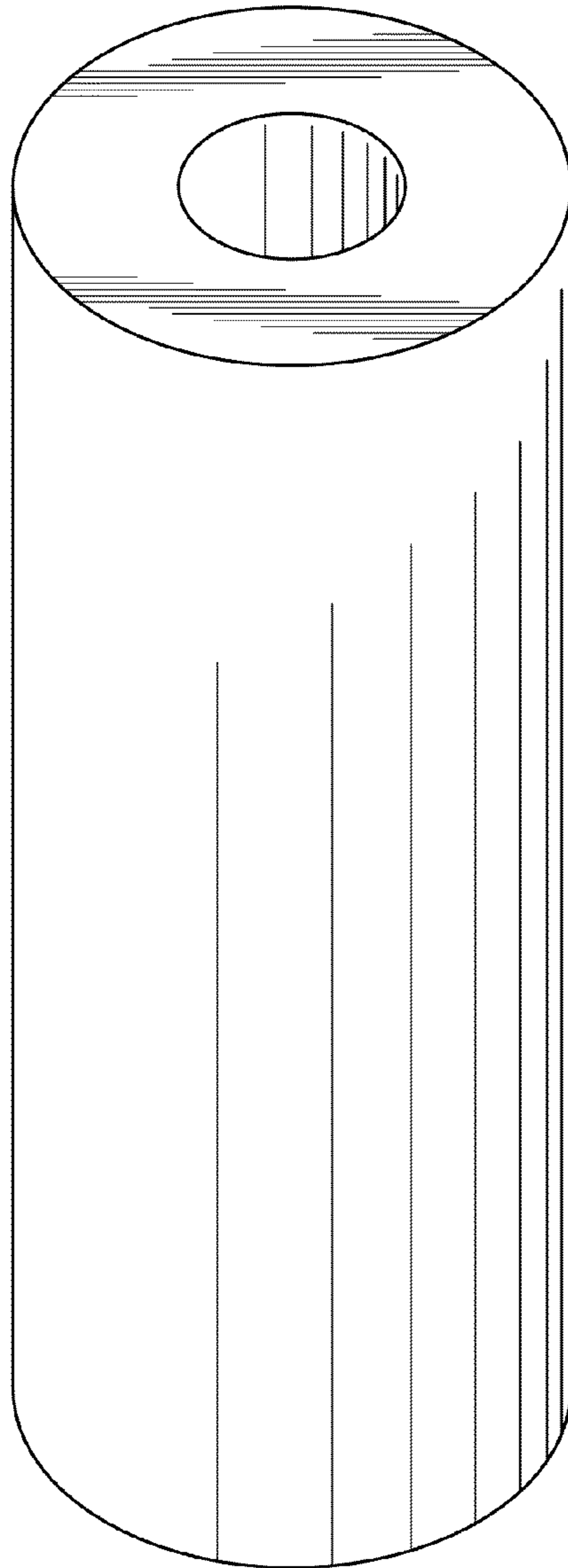

FIG. 13

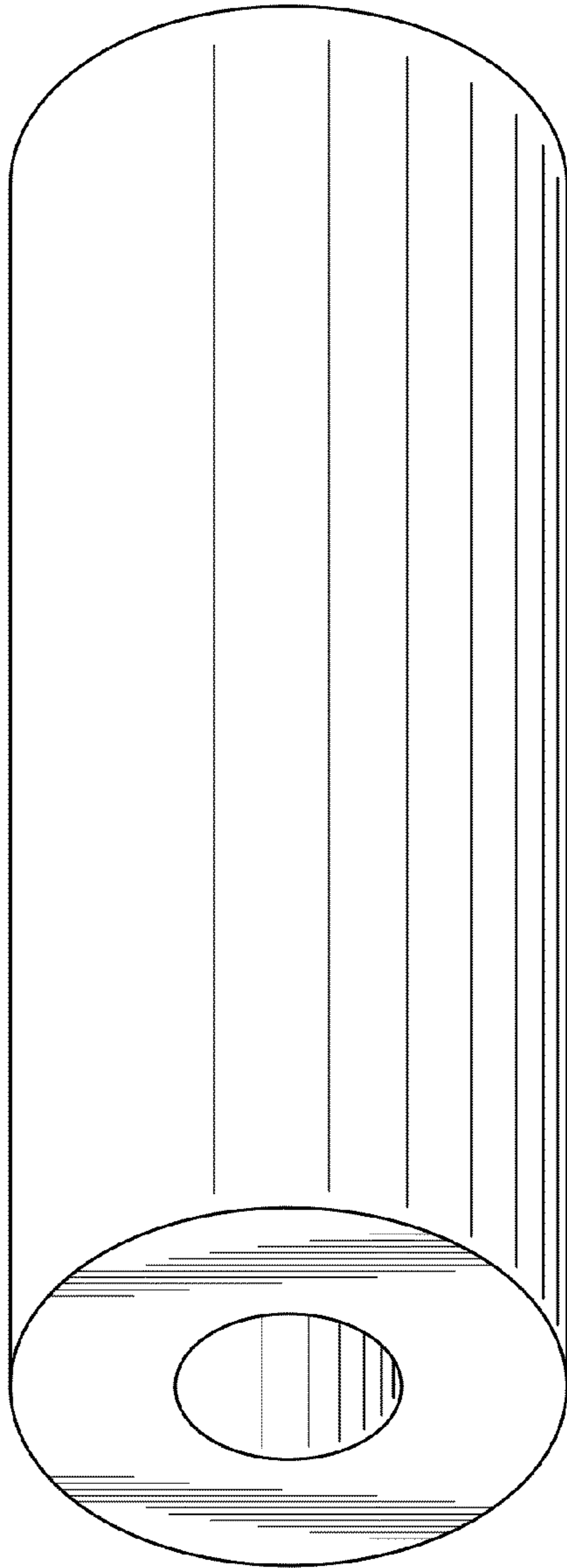

FIG. 14

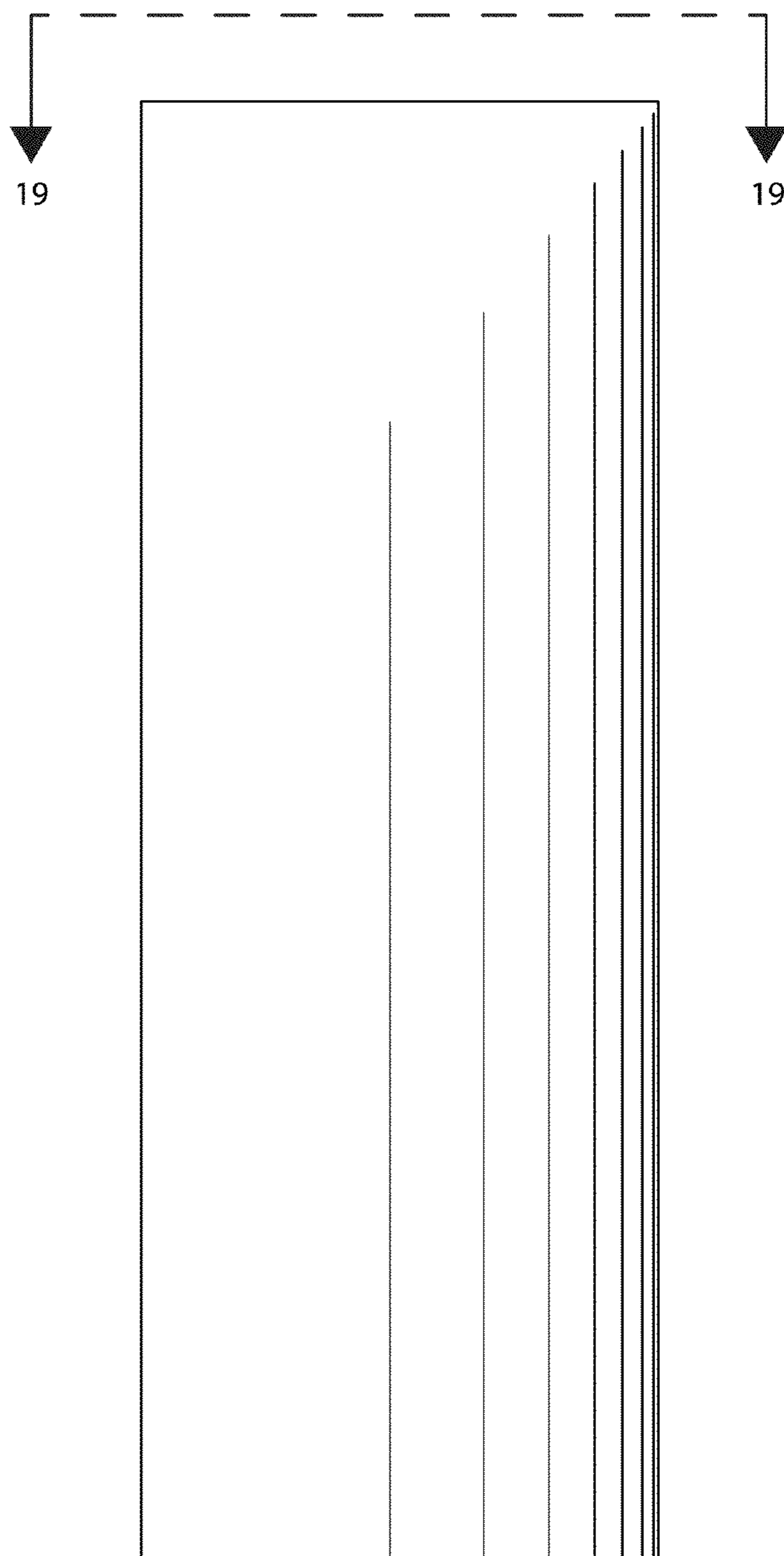

FIG. 15

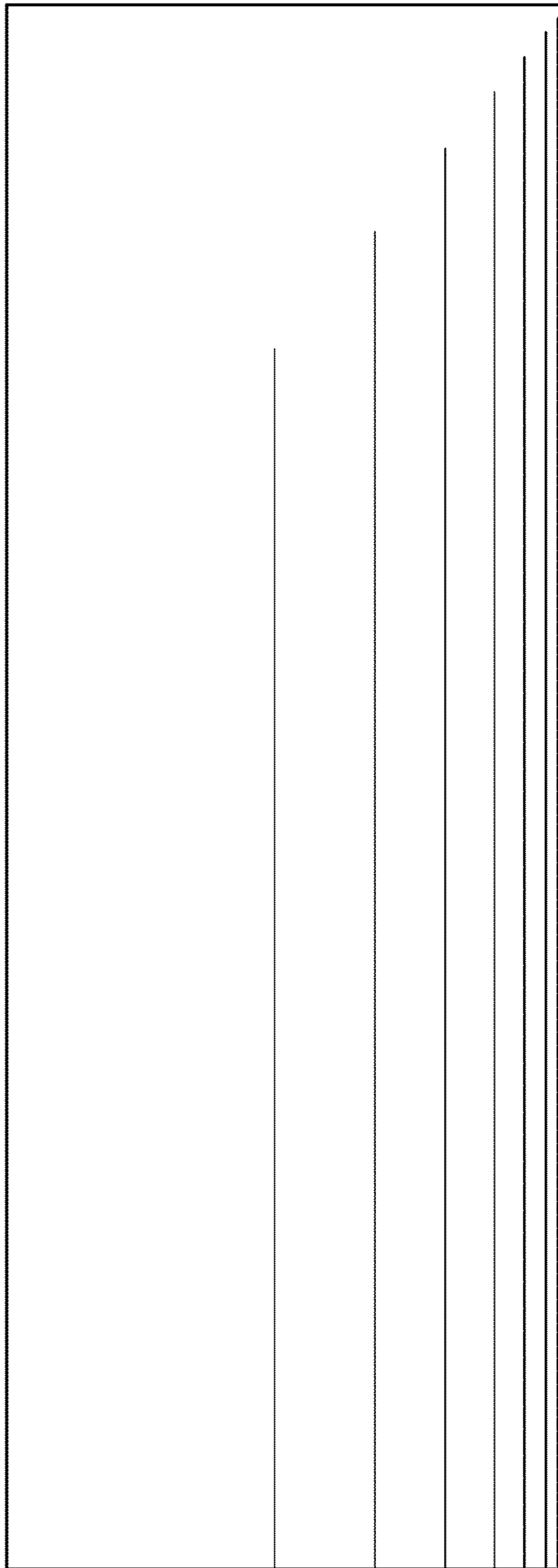

FIG. 16

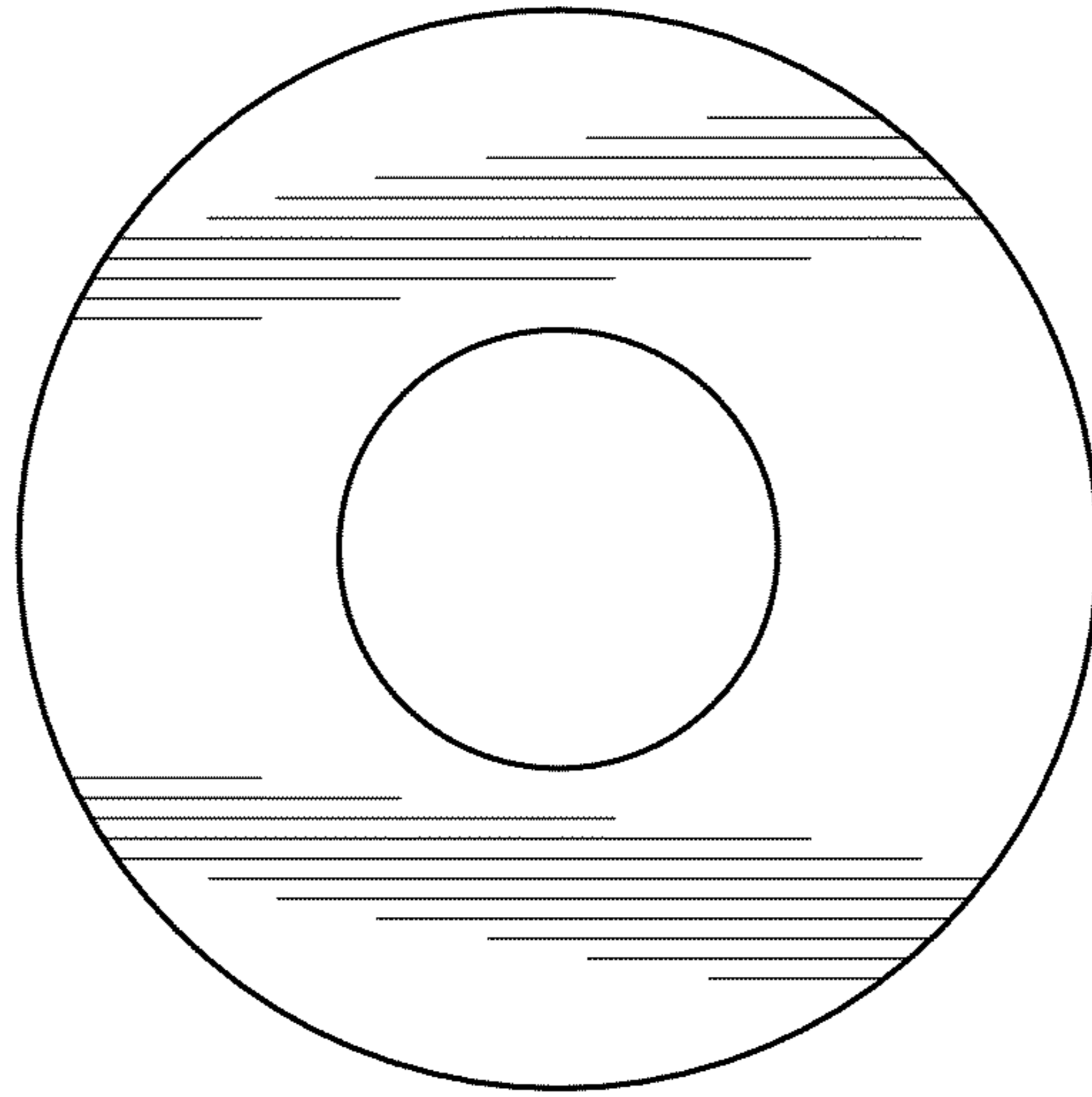

FIG. 17

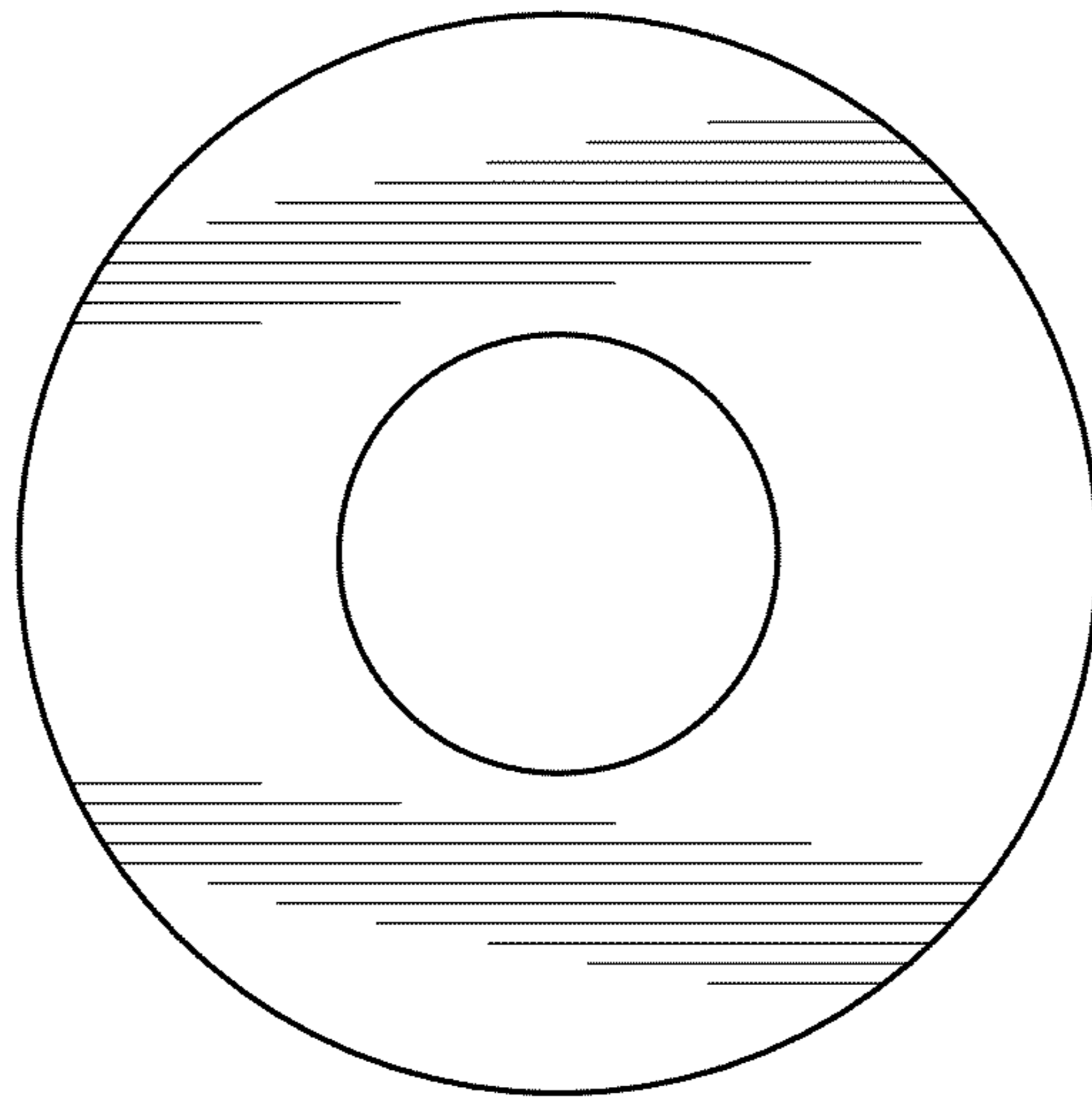

FIG. 18

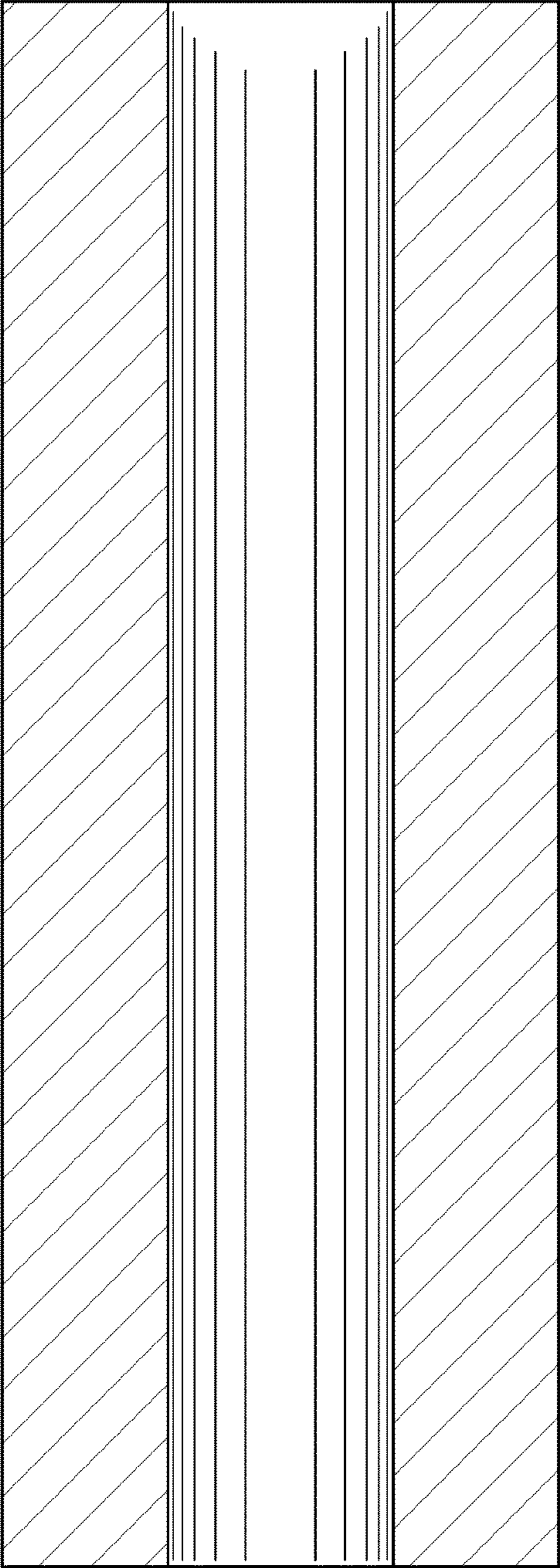

FIG. 19

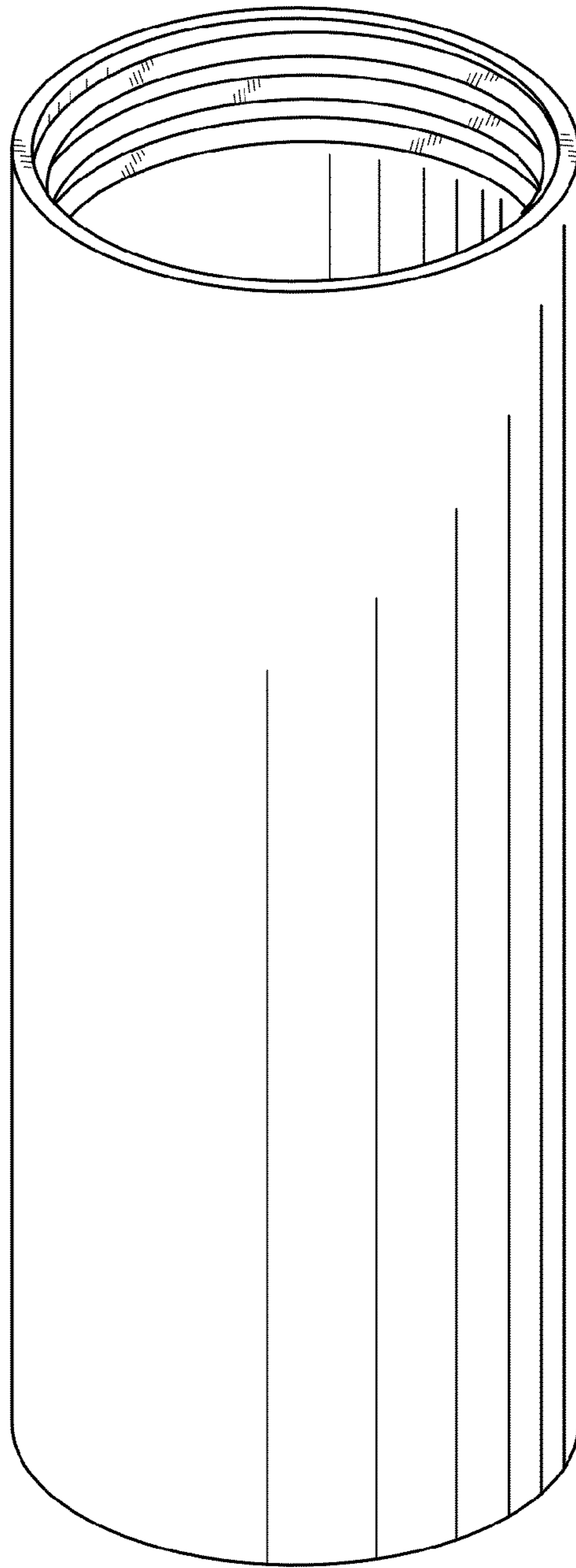

FIG. 20

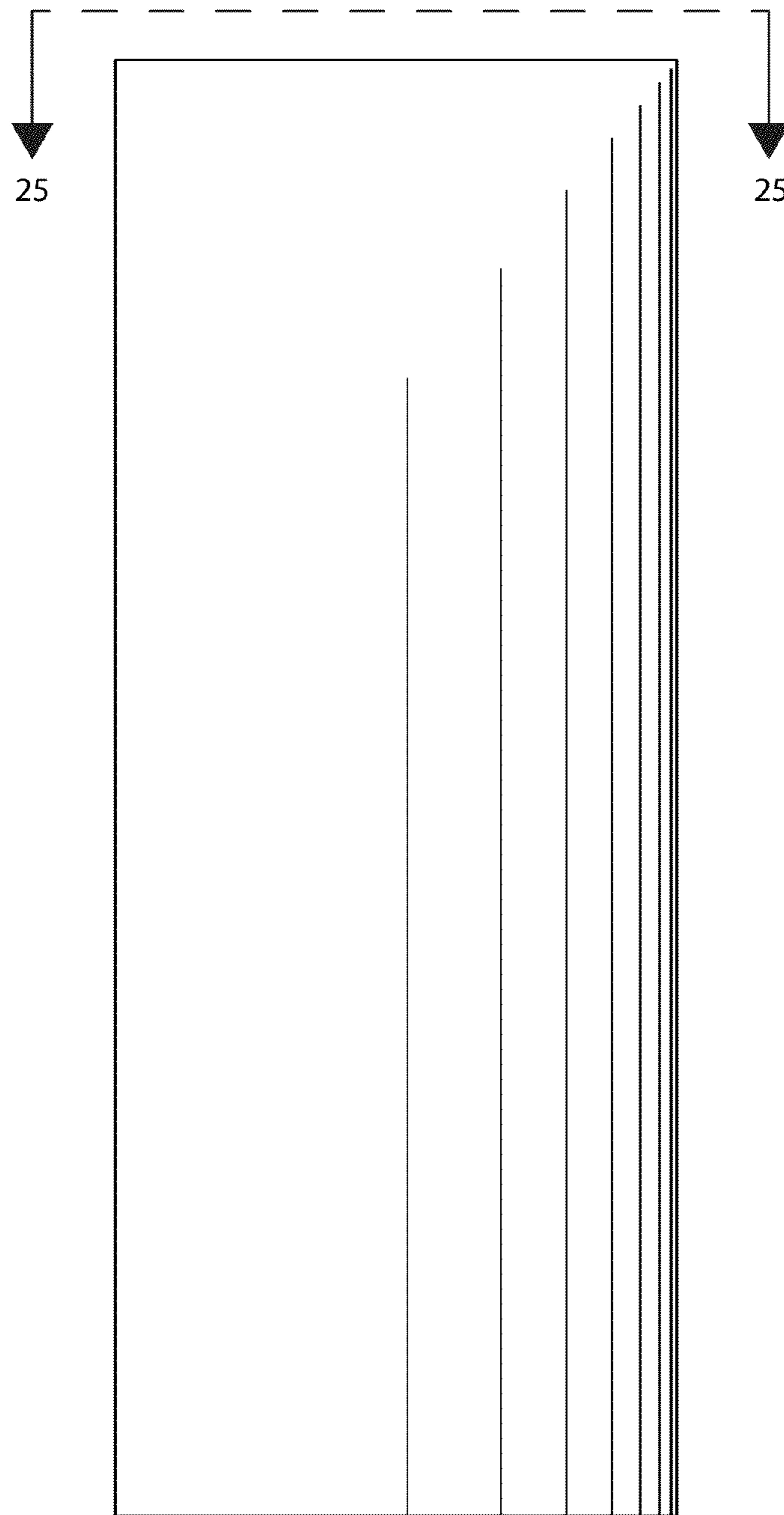

FIG. 21

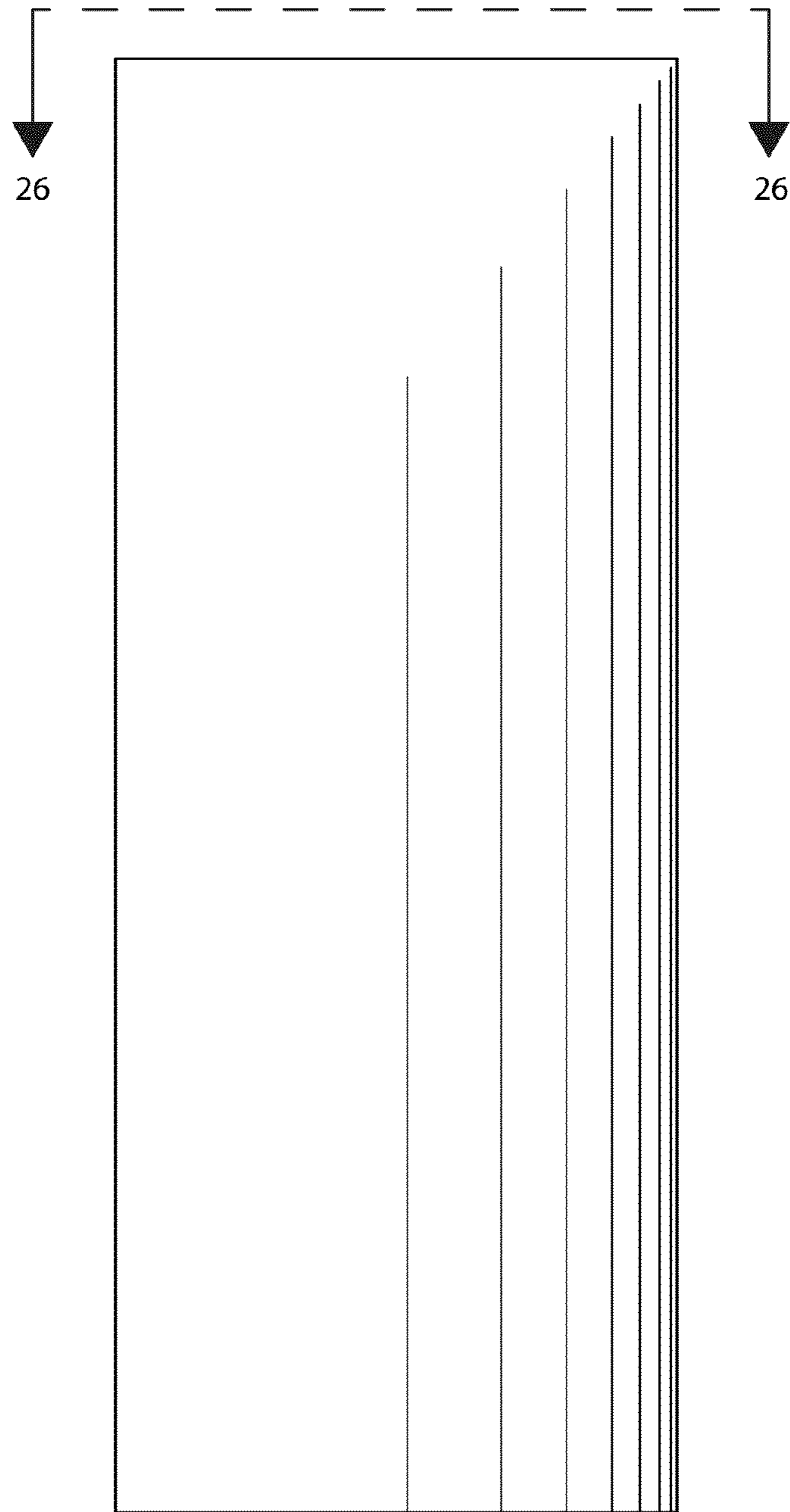

FIG. 22

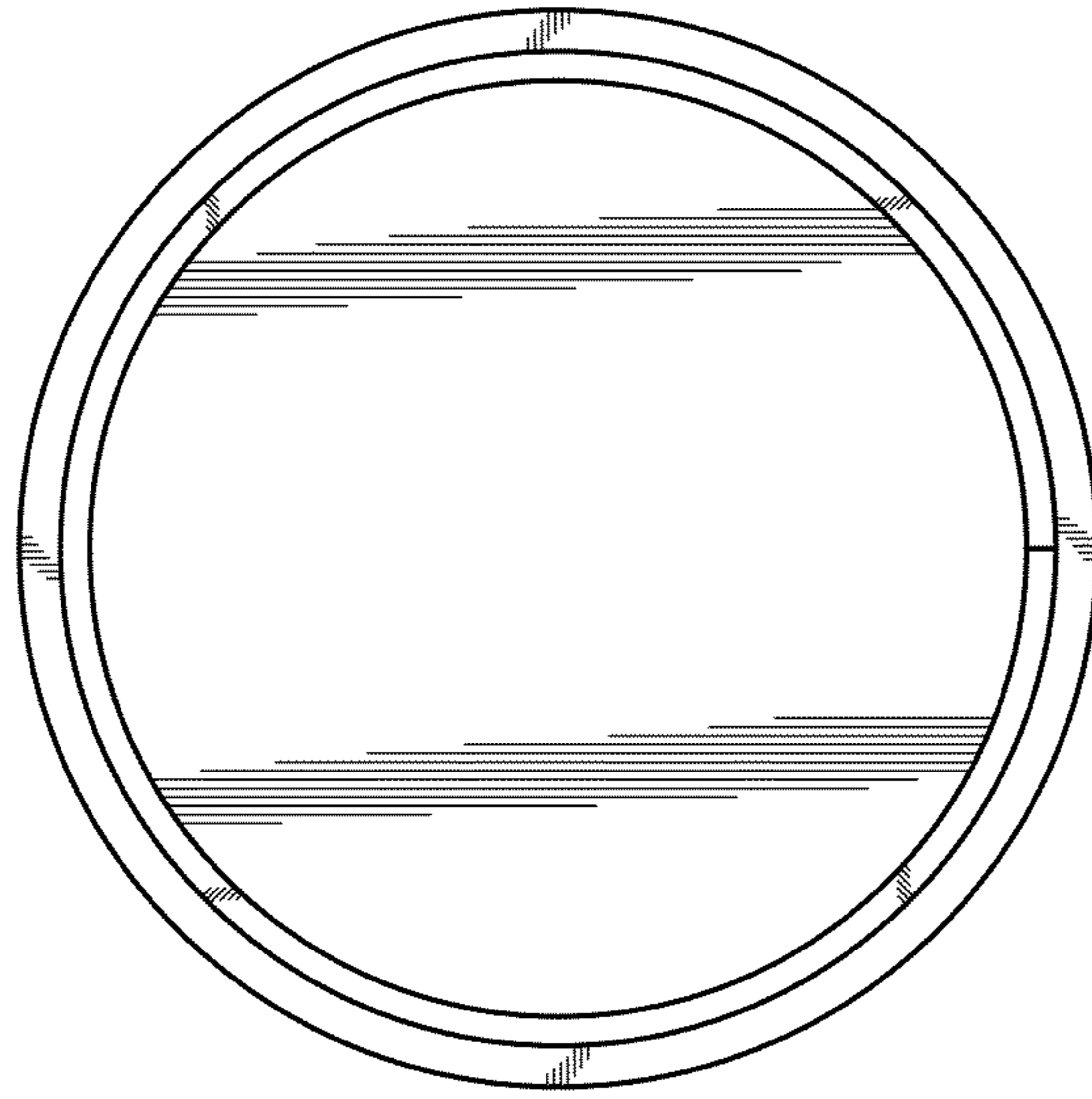

FIG. 23

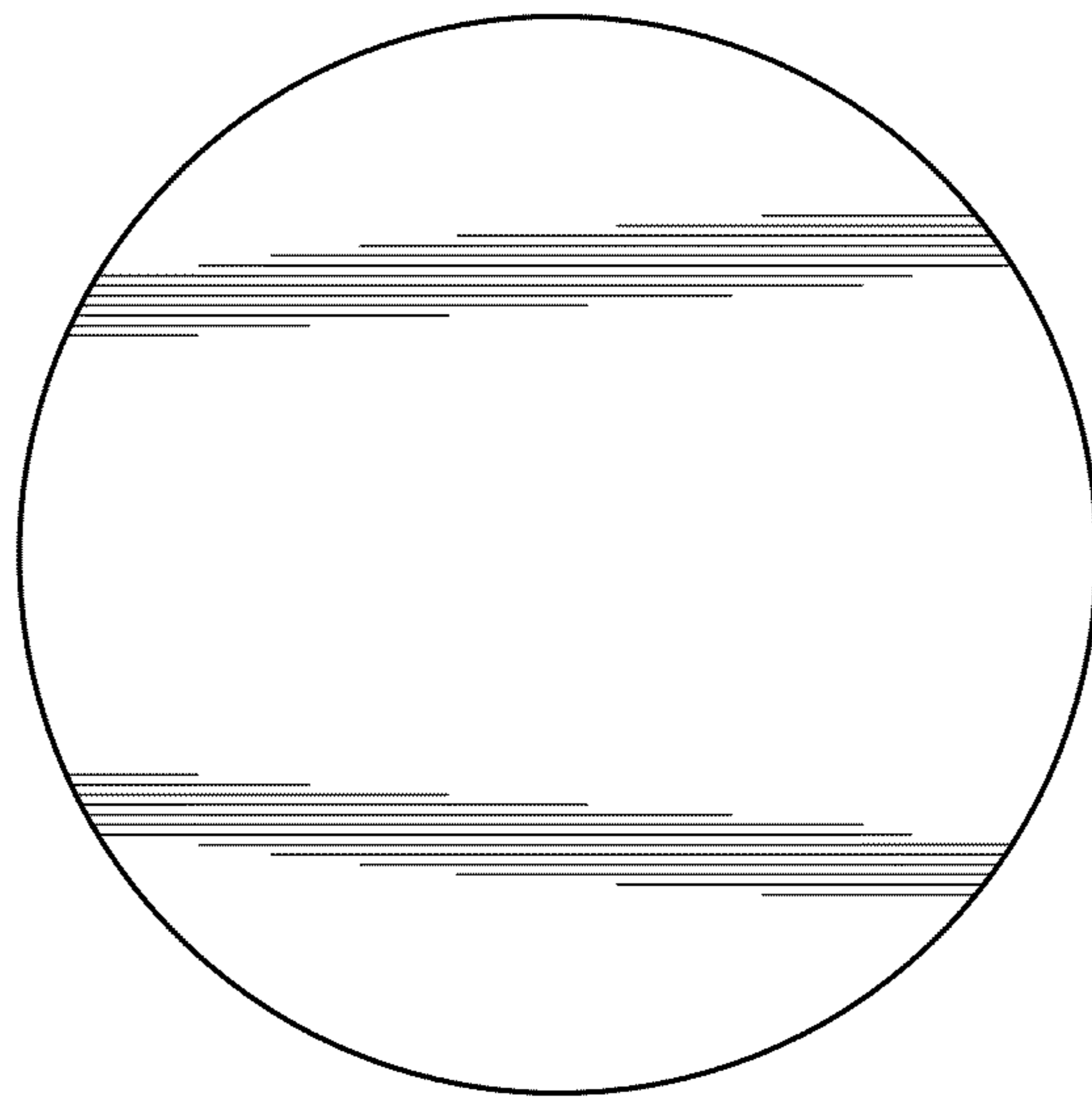

FIG. 24

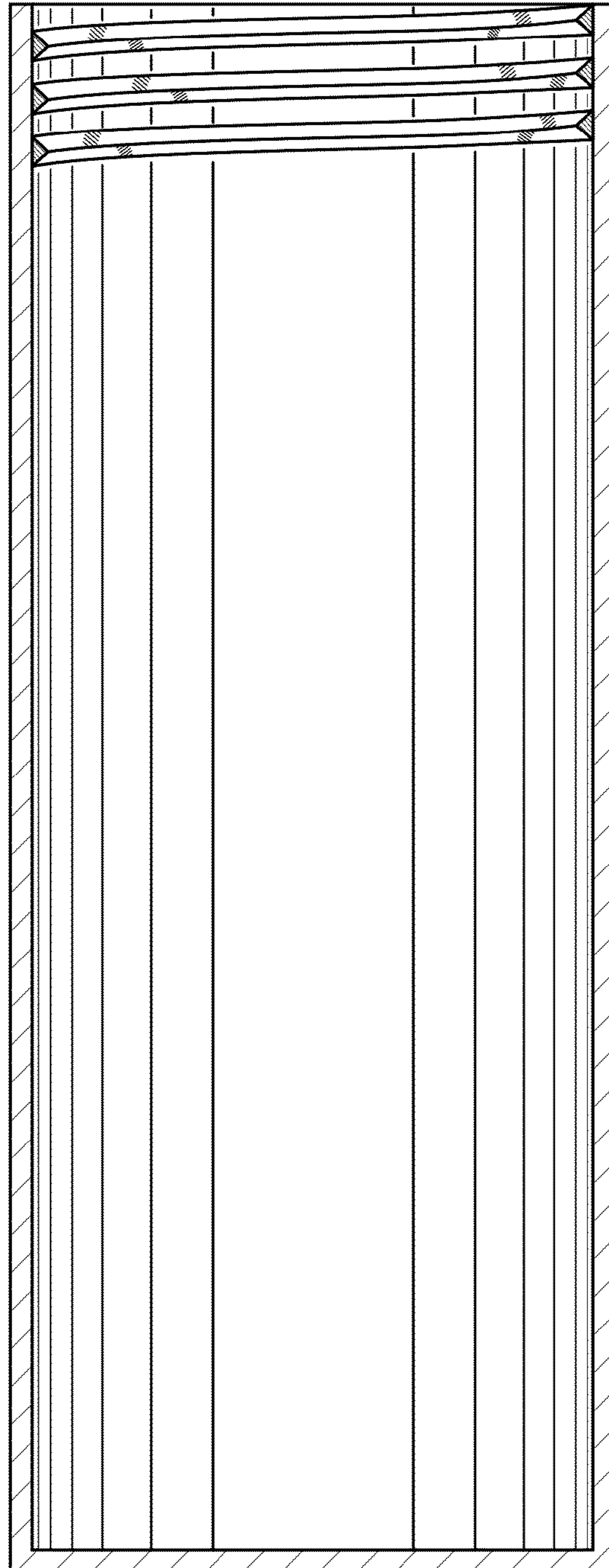

FIG. 25

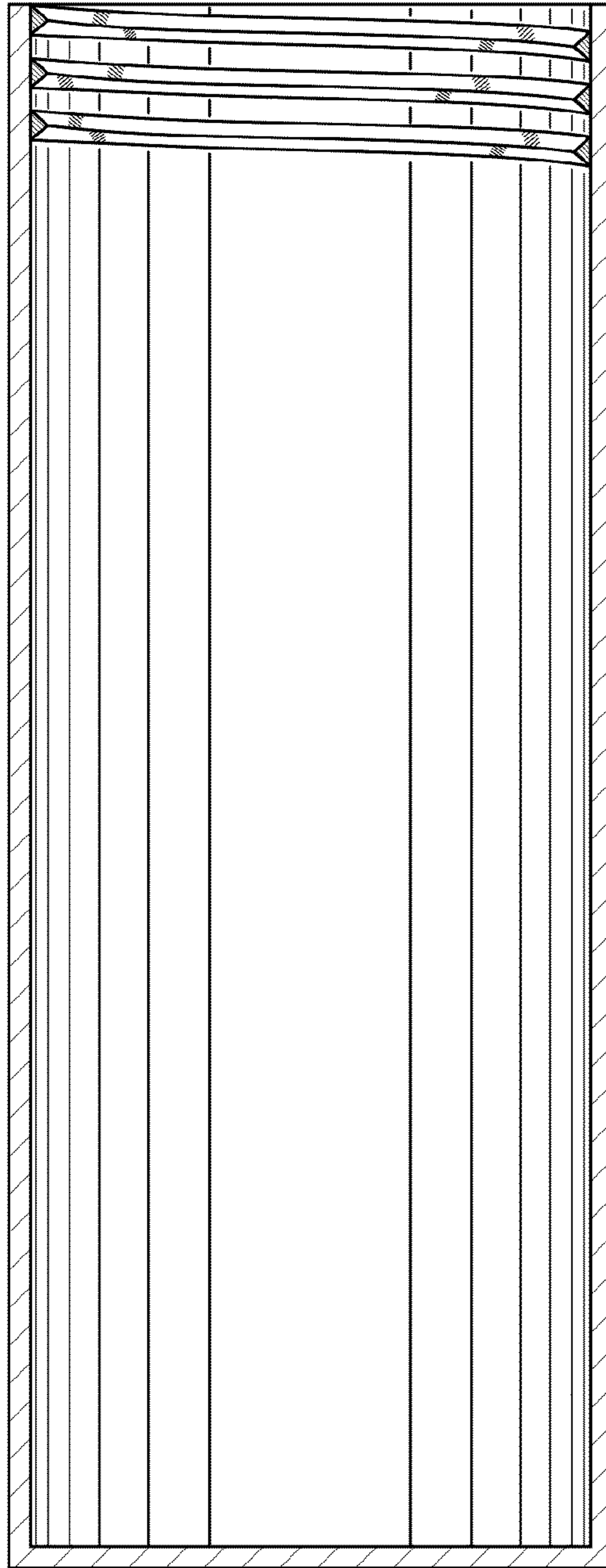

FIG. 26