



US00D758700S

(12) **United States Design Patent**
Borovicka

(10) **Patent No.:** **US D758,700 S**
(45) **Date of Patent:** **** Jun. 14, 2016**

(54) **HOODED GARMENT**

(71) Applicant: **NIKE, Inc.**, Beaverton, OR (US)

(72) Inventor: **Vanessa L. Borovicka**, Lake Oswego, OR (US)

(73) Assignee: **NIKE, Inc.**, Beaverton, OR (US)

(**) Term: **14 Years**

(21) Appl. No.: **29/520,864**

(22) Filed: **Mar. 18, 2015**

(51) **LOC (10) Cl.** **02-02**

(52) **U.S. Cl.**
USPC **D2/831**

(58) **Field of Classification Search**
USPC D2/717, 731, 749, 750, 753, 755,
D2/828-831, 833, 834, 836, 839, 840, 841
See application file for complete search history.

(56) **References Cited**

U.S. PATENT DOCUMENTS

D129,909 S	10/1941	Turcotte	
D130,379 S	11/1941	Leventhal	
D148,682 S	2/1948	Etkin	
D553,329 S	10/2007	Wager	
D553,330 S	10/2007	Wager	
D584,482 S	1/2009	Marsh	
D630,001 S	1/2011	Brown	
D662,284 S *	6/2012	Lam	D2/831
D663,101 S	7/2012	Best et al.	
D665,152 S	8/2012	Morales	
D685,160 S	7/2013	Savage	
D695,491 S	12/2013	Hawkins et al.	
D705,522 S	5/2014	Borovicka et al.	
D707,923 S	7/2014	Borovicka et al.	
D713,126 S	9/2014	Franz et al.	
D714,028 S *	9/2014	Borovicka	D2/831
D714,524 S	10/2014	Borovicka	
D714,526 S *	10/2014	Ingram	D2/831
D715,029 S	10/2014	Roberts et al.	
D734,593 S *	7/2015	Borovicka	D2/831

D736,497 S *	8/2015	Harris	D2/831
D744,724 S *	12/2015	Borovicka	D2/828
2006/0053525 A1 *	3/2006	Legard	A41D 13/1245 2/114

OTHER PUBLICATIONS

Jordan Dominate Pullover Sleeveless Hoodie found online [Jan. 5, 2016] <http://www.finishline.com/store/product/men-s-jordan-dominate-pullover-sleeveless-hoodie?productId=prod744698>.
Nike Apparel Catalog, Fall 2010 Performance Apparel, p. 41, published date unknown, but prior to the filing date of the present application, NIKE, Inc., USA.

(Continued)

Primary Examiner — Robert M Spear

Assistant Examiner — John Voytek

(74) *Attorney, Agent, or Firm* — Banner & Witcoff, Ltd.

(57) **CLAIM**

The ornamental design for a hooded garment, as shown and described.

DESCRIPTION

FIG. 1 is a front left perspective view of a hooded garment showing my new design in an in-use configuration with a hood in an up position;
FIG. 2 is a front right perspective view thereof;
FIG. 3 is a front view thereof;
FIG. 4 is a rear view thereof;
FIG. 5 is a left side view thereof;
FIG. 6 is a right side view thereof; and,
FIG. 7 is a top view thereof.
The broken lines immediately adjacent to the shaded area represent unclaimed boundaries of the design. The unshaded regions, demarcated by broken lines, represent unclaimed portions of the hooded garment and form no part of the claimed design. The broken lines showing the remainder of the hooded garment are for environmental purposes only and form no part of the claimed design.

1 Claim, 7 Drawing Sheets

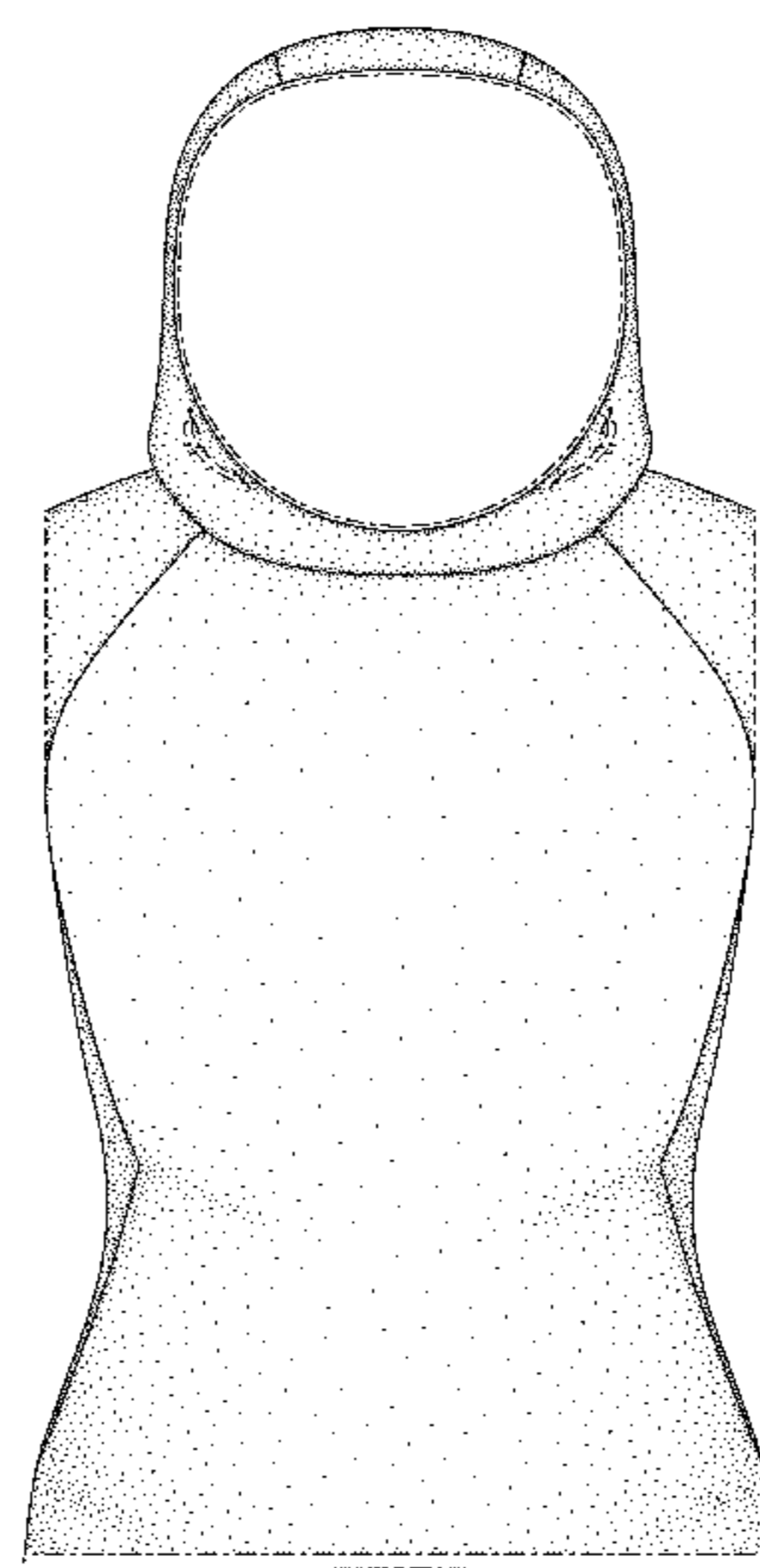
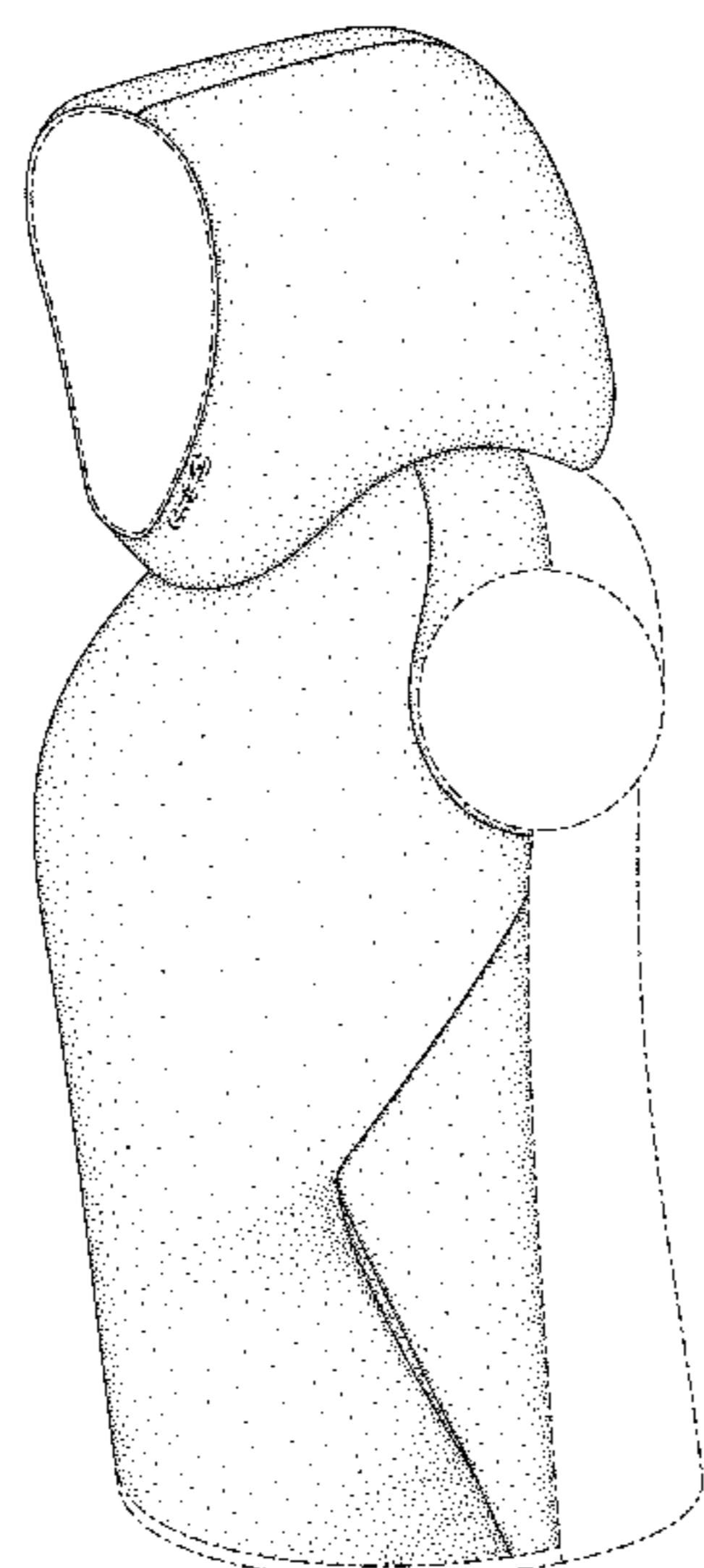

(56)

References Cited

OTHER PUBLICATIONS

Nike Apparel Catalog, Fall 2010 Performance Apparel, p. 80, published date unknown, but prior to the filing date of the present application, NIKE, Inc., USA.

Nike Apparel Catalog, Holiday 2010 Men's Apparel Sportswear, p. 5, published date unknown, but prior to the filing date of the present application, NIKE, Inc., USA.

Nike Apparel Catalog, Holiday 2010 Men's Apparel Sportswear, p. 18, published date unknown, but prior to the filing date of the present application, NIKE, Inc., USA.

Nike Apparel Catalog, Summer 2010 Sport Apparel, p. 122, published Aug. 2009, NIKE, Inc., USA.

Nike Apparel Catalog, Fall 2011 Men's Apparel: Athletic Dept./Classics, p. 5, published date unknown, but prior to the filing date of the present application, NIKE, Inc., USA.

* cited by examiner

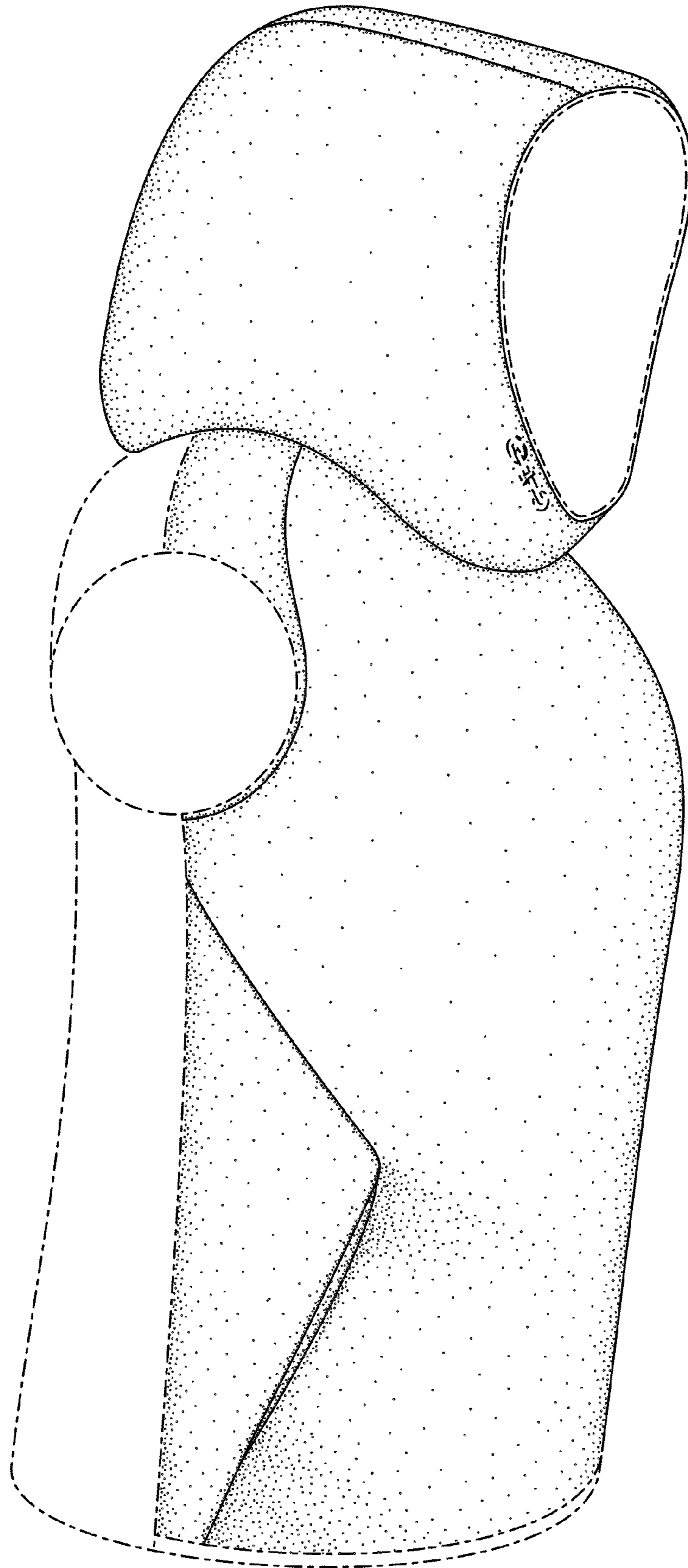

FIG. 1

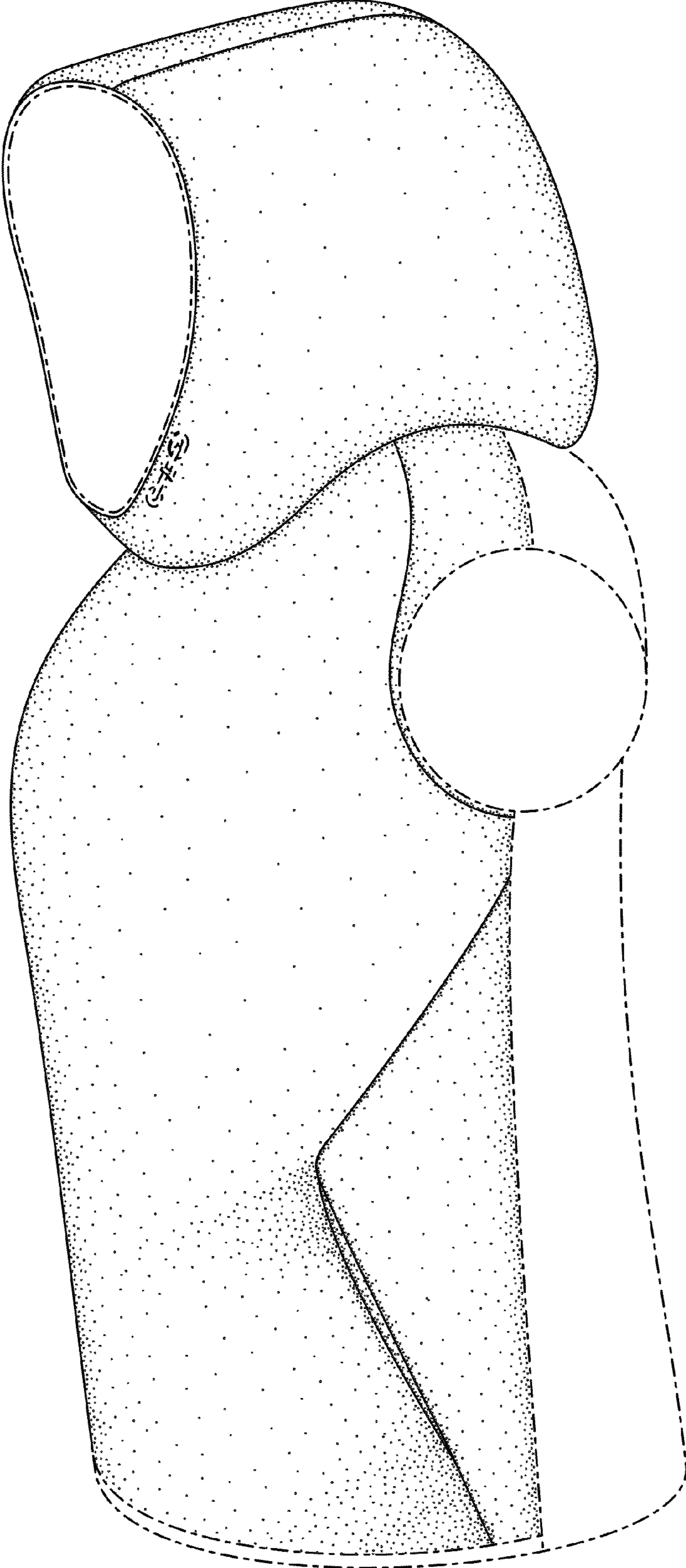

FIG. 2

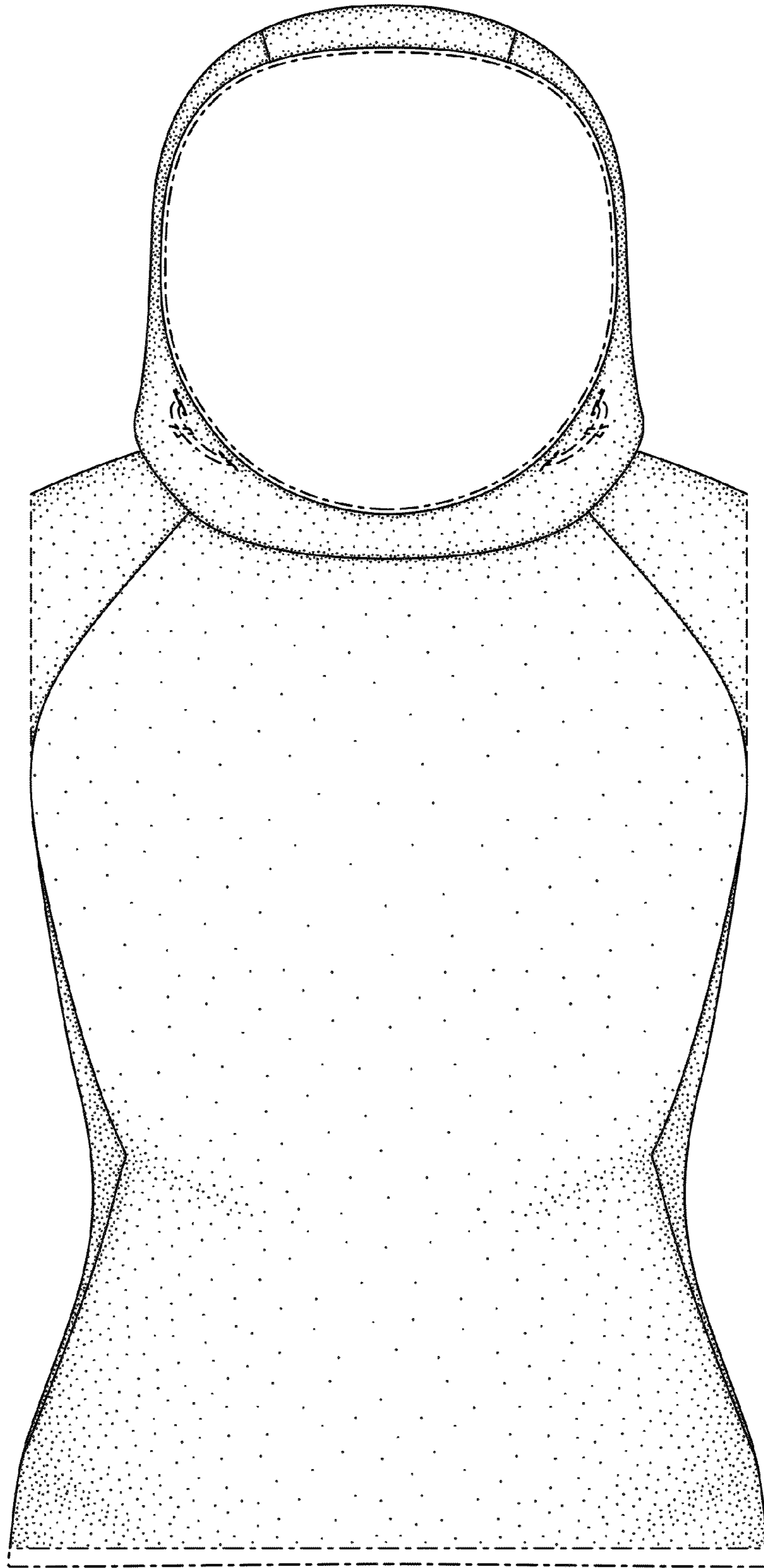

FIG. 3

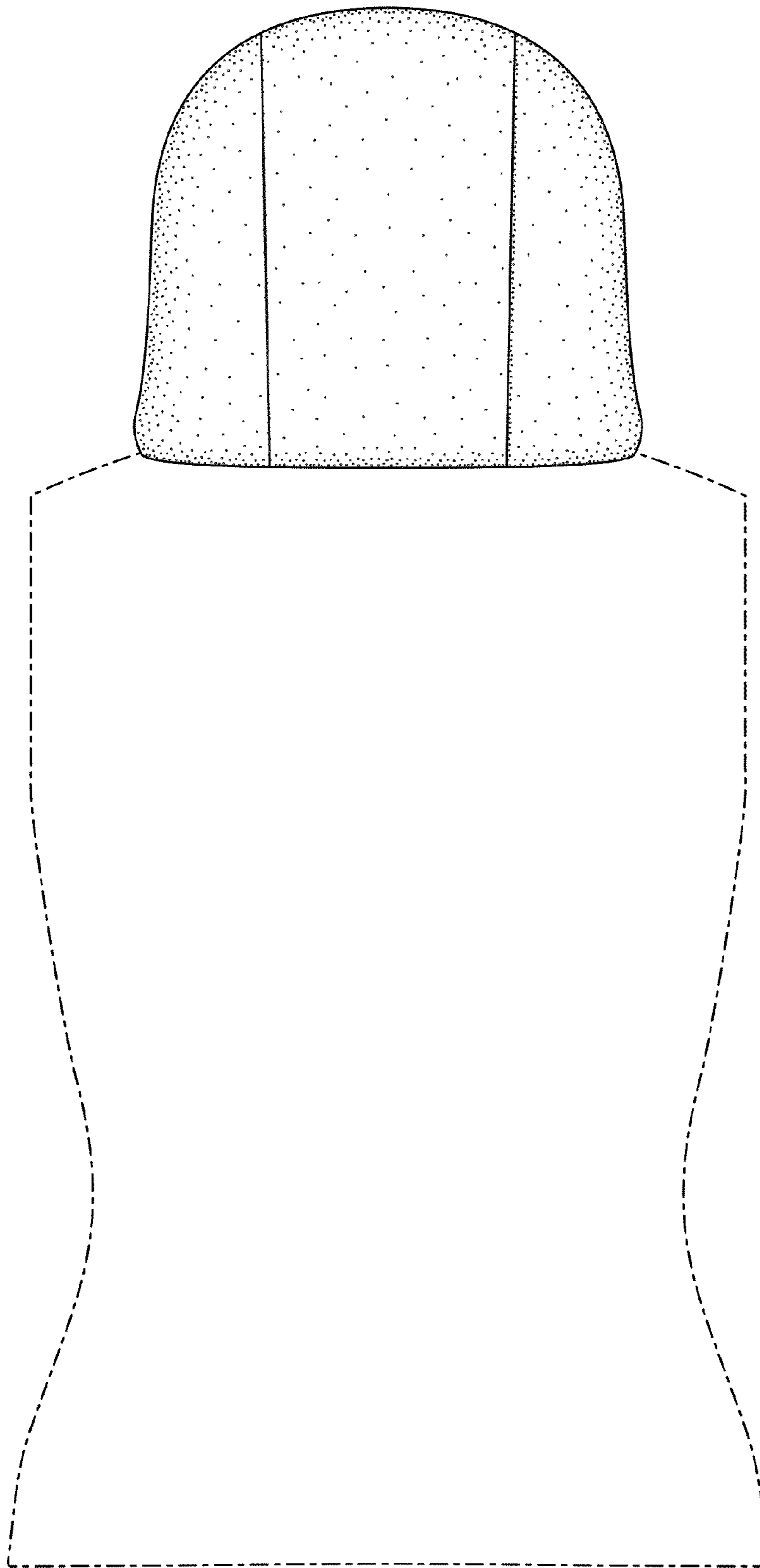

FIG. 4

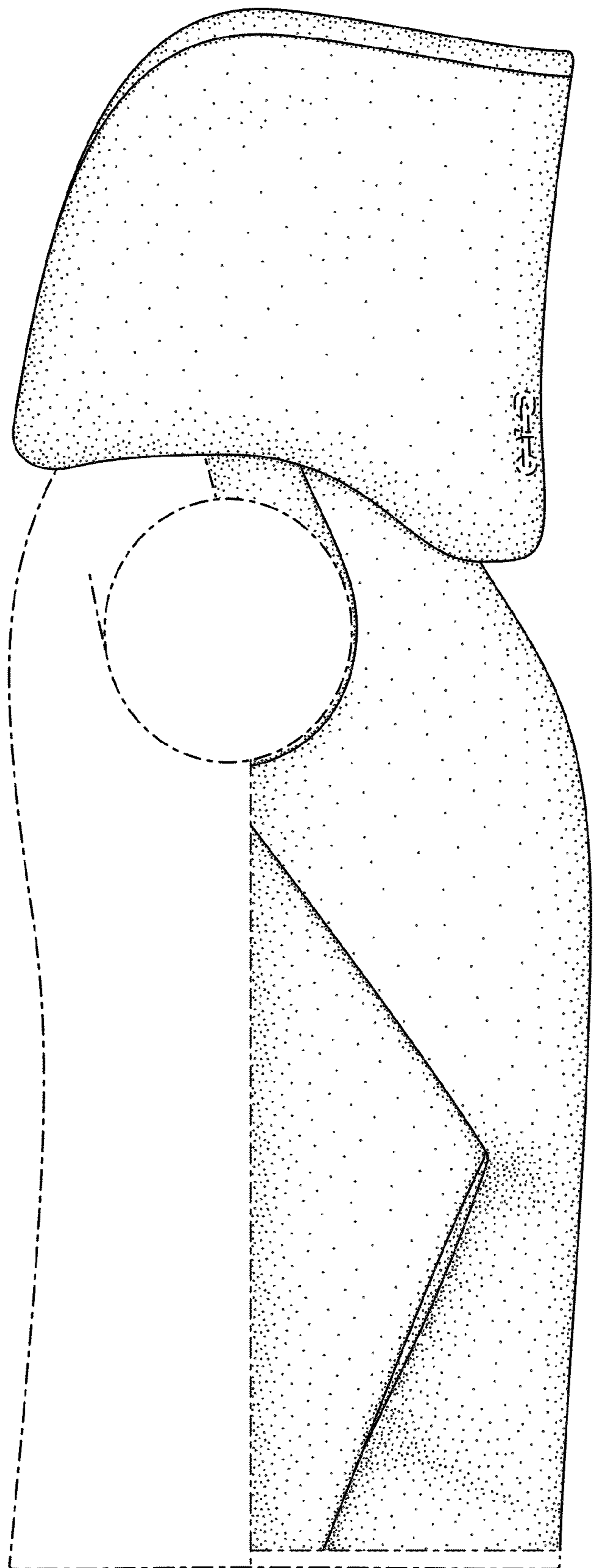

FIG. 5

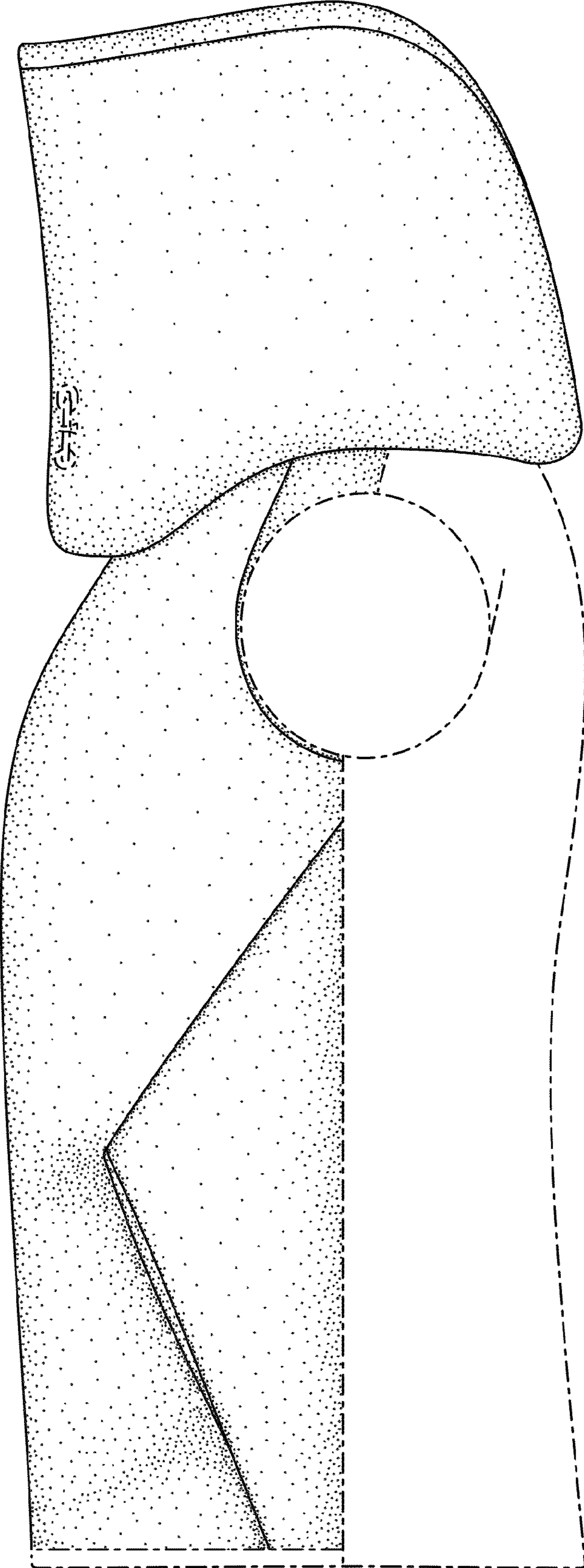

FIG. 6

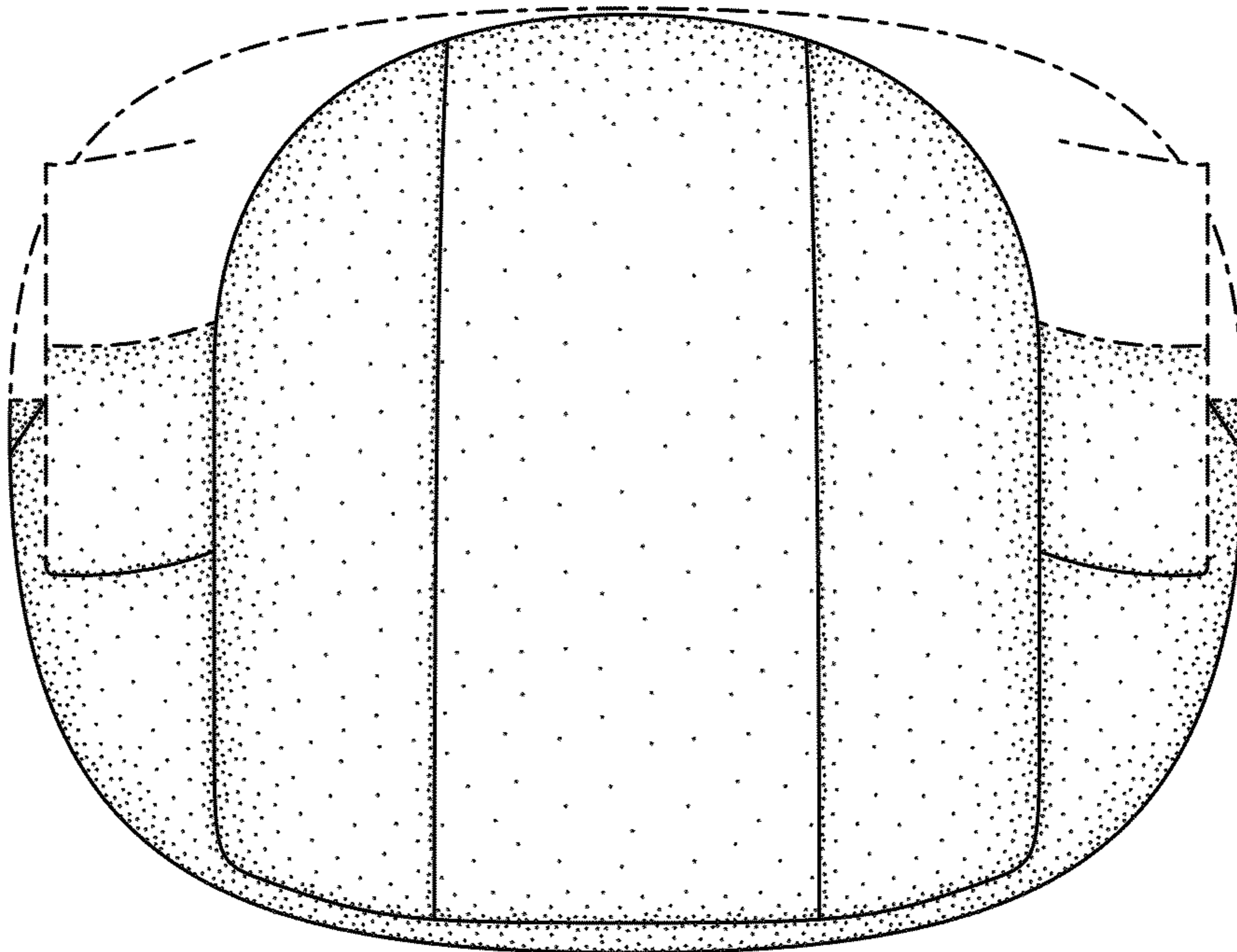

FIG. 7