



US00D758609S

(12) **United States Design Patent**  
**Schindler et al.**

(10) **Patent No.:** **US D758,609 S**  
(45) **Date of Patent:** **\*\* Jun. 7, 2016**

(54) **GUARDRAIL BASE**

(71) Applicants: **Braxton Schindler**, Heber, UT (US);  
**Nathan Sargent**, Heber, UT (US);  
**Tyson Matheson Munford**, Heber, UT  
(US); **Joshua Paul Adam**, Heber, UT  
(US); **Kynan Wynne**, Heber City, UT  
(US)

(72) Inventors: **Braxton Schindler**, Heber, UT (US);  
**Nathan Sargent**, Heber, UT (US);  
**Tyson Matheson Munford**, Heber, UT  
(US); **Joshua Paul Adam**, Heber, UT  
(US); **Kynan Wynne**, Heber City, UT  
(US)

(\*\*) **Term:** **14 Years**

(21) **Appl. No.:** **29/483,173**

(22) **Filed:** **Feb. 26, 2014**

(51) **LOC (10) Cl.** ..... **25-01**

(52) **U.S. Cl.**  
USPC ..... **D25/38.1**

(58) **Field of Classification Search**  
USPC ..... 52/155, 157, 295; 405/259.1, 259.4,  
405/184.4; 135/118; 248/156, 530;  
256/65.14; D25/38.1, 46, 68, 35, 11  
CPC ..... E02D 5/80; E02D 5/805; E02D 2600/20;  
E04H 15/62; E04H 12/2253; E04H 12/2284;  
E04H 17/08; E04H 17/22; E04H 12/2261;  
E04H 2017/006; E04H 12/2292; F16M  
2200/08

See application file for complete search history.

(56) **References Cited**

**U.S. PATENT DOCUMENTS**

4,763,456 A 8/1988 Giannuzzi  
5,816,554 A 10/1998 McCracken  
6,053,281 A 4/2000 Murray

6,076,778 A 6/2000 Brown  
6,439,344 B1 8/2002 Cole  
6,554,257 B1 4/2003 Kenton  
D486,250 S \* 2/2004 Mettler et al. .... D25/133  
6,902,153 B1 6/2005 Kenton  
D513,536 S \* 1/2006 Walker ..... D25/133  
7,216,839 B2 \* 5/2007 Xiaoqiu et al. .... 248/346.2  
D571,486 S \* 6/2008 Miller et al. .... D25/133  
D625,433 S \* 10/2010 Preston ..... D25/133  
D673,306 S \* 12/2012 Chung ..... D25/133

(Continued)

**FOREIGN PATENT DOCUMENTS**

JP 2002021285 1/2002  
KR 102011089558 8/2011  
WO 2009065185 5/2009

**OTHER PUBLICATIONS**

Internet search URL<<http://rooftopanchors.dev09.net/products/>  
[date searched Jun. 10, 2015].\*

*Primary Examiner* — Philip S Hyder

*Assistant Examiner* — Keith Frank

(74) *Attorney, Agent, or Firm* — Brian J. Riddle; Fabian  
VanCott

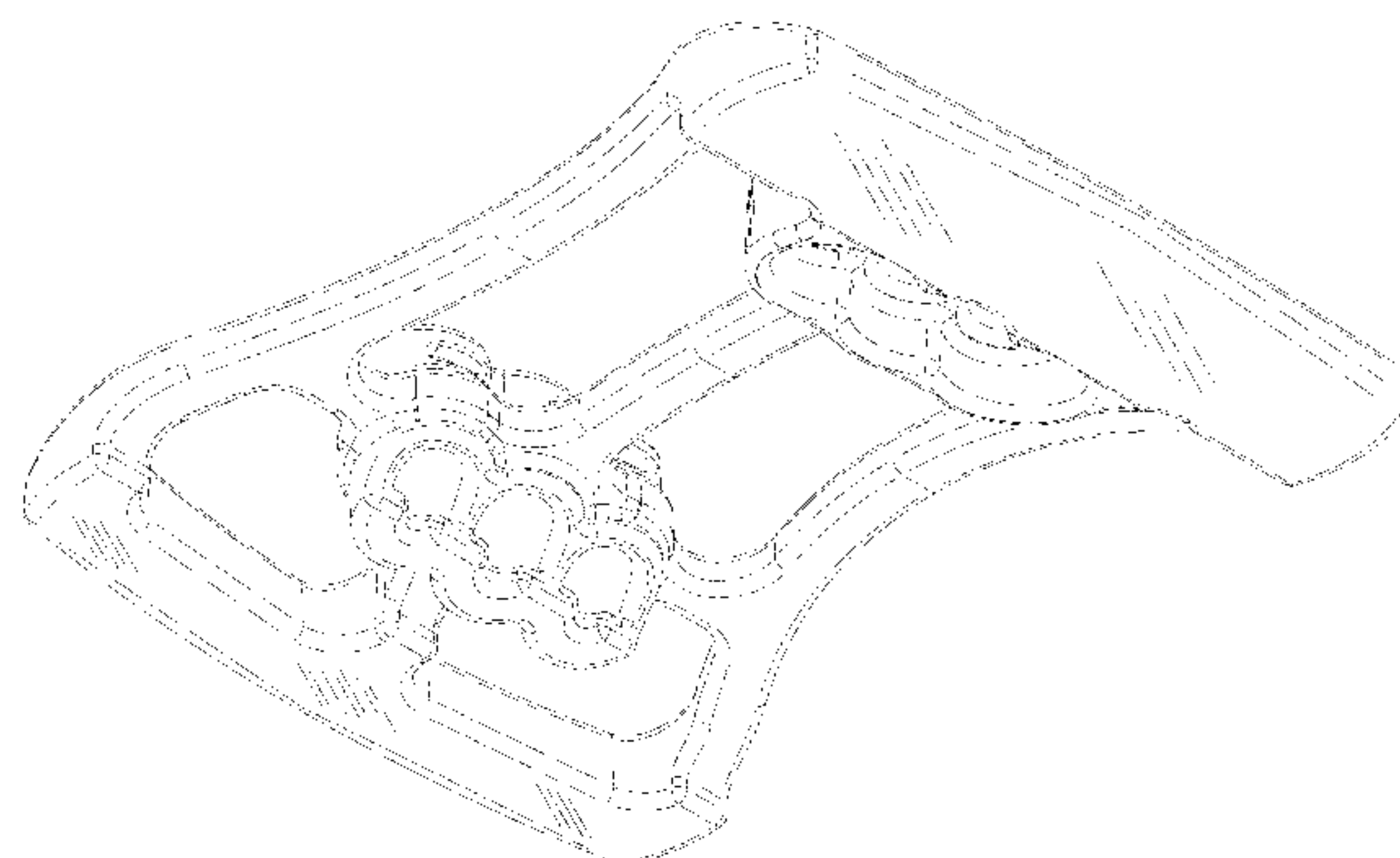
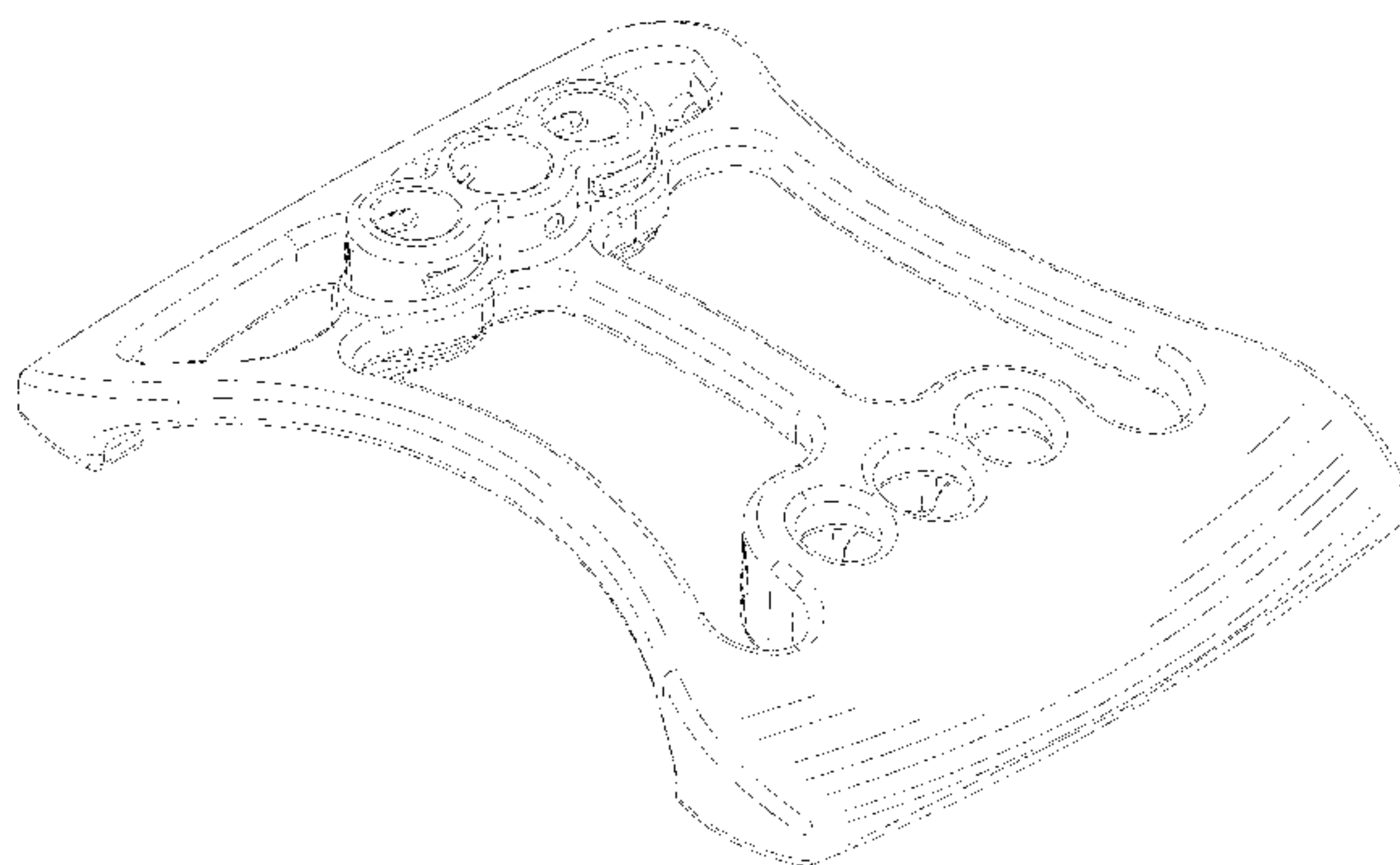
(57) **CLAIM**

The ornamental design for a guardrail base, as shown and  
described.

**DESCRIPTION**

FIG. 1 is a top perspective view of the guardrail base.  
FIG. 2 is a bottom perspective view of the guardrail base.  
FIG. 3 is a top plan view of the guardrail base.  
FIG. 4 is a bottom plan view of the guardrail base.  
FIG. 5 is a left side perspective view of the guardrail base.  
FIG. 6 is a right side perspective view of the guardrail base.  
FIG. 7 is a rear elevation view of the guardrail base; and,  
FIG. 8 is a front elevation view of the guardrail base.

**1 Claim, 8 Drawing Sheets**



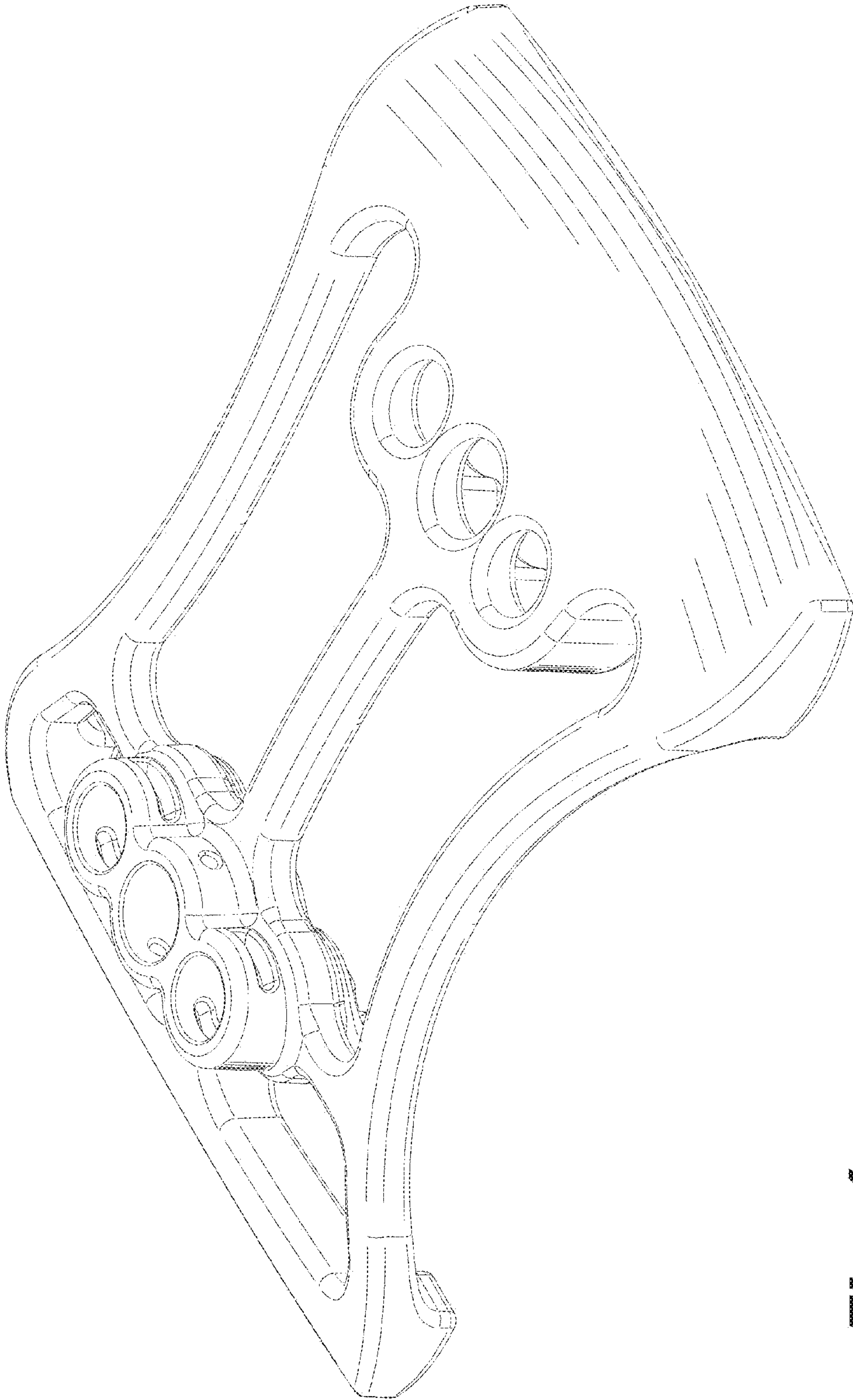
(56)

**References Cited**

U.S. PATENT DOCUMENTS

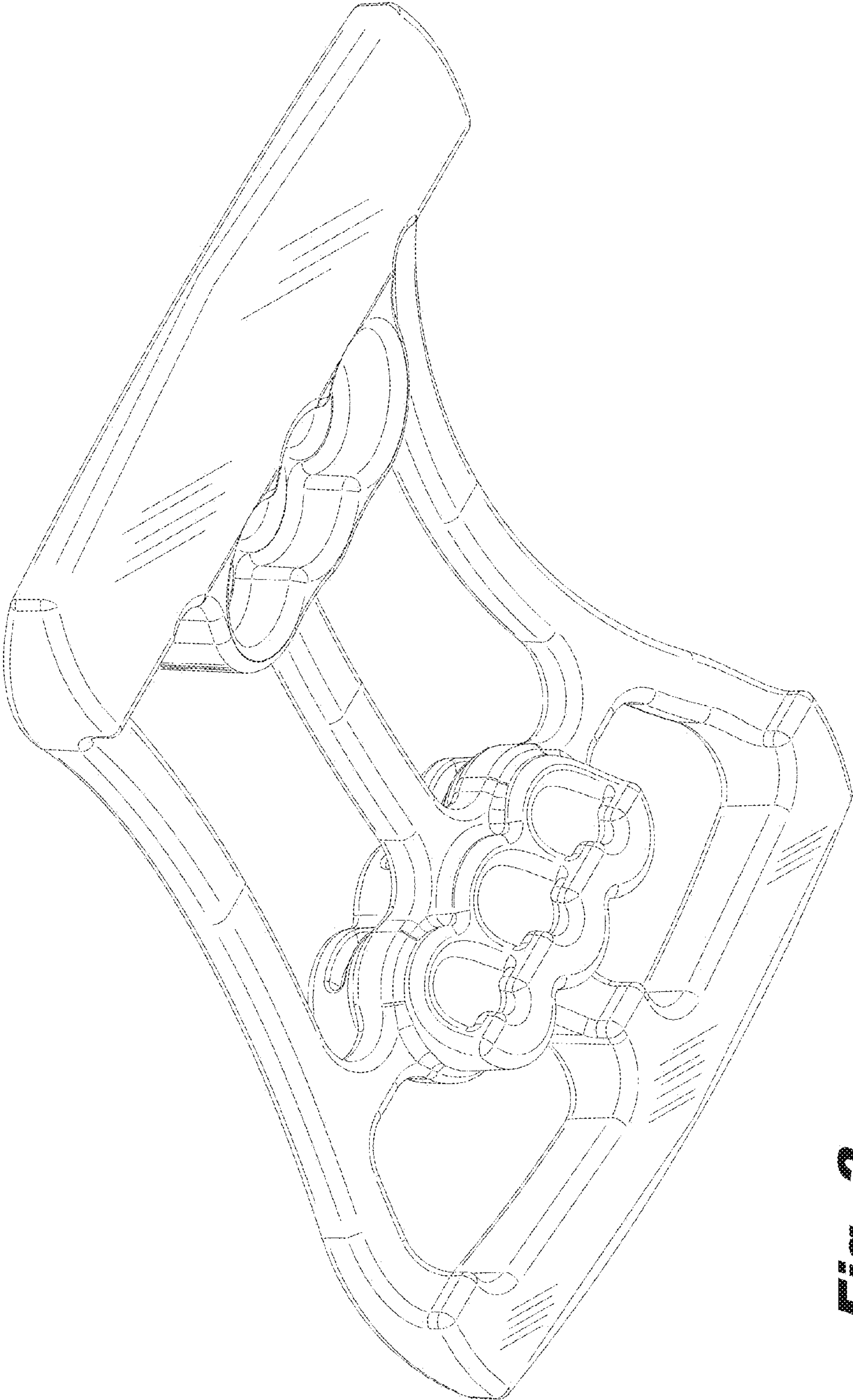
8,978,676	B2 *	3/2015	Williams	.....	135/16	2007/0117442	A1 *	5/2007	Melic	.....	439/328
9,004,439	B2 *	4/2015	Gross et al.	.....	248/507	2008/0237560	A1 *	10/2008	Dehlsen	.....	256/65.14
2001/0006231	A1	7/2001	McCracken			2011/0253962	A1 *	10/2011	Sadinsky et al.	.....	256/24
2002/0109065	A1 *	8/2002	Clores	.....	248/519	2013/0167470	A1	7/2013	Montgomery et al.		
2003/0213948	A1 *	11/2003	Striebel et al.	.....	256/67	2014/0008506	A1	1/2014	Schaefer et al.		
2004/0031902	A1 *	2/2004	Davis, Jr.	.....	248/519	2014/0013677	A1	1/2014	McPheeters et al.		
2004/0065794	A1 *	4/2004	Higgs et al.	.....	248/188.8	2014/0026486	A1	1/2014	Vavaris		
2005/0056741	A1 *	3/2005	Higgs et al.	.....	248/188.8	2014/0231737	A1 *	8/2014	Whiteley	.....	256/24
2006/0011901	A1	1/2006	Anson et al.			2015/0021535	A1 *	1/2015	Tomczak	.....	256/65.14
						2015/0041613	A1 *	2/2015	Ray	.....	248/523
						2015/0041744	A1 *	2/2015	Higgs	.....	256/65.01

\* cited by examiner

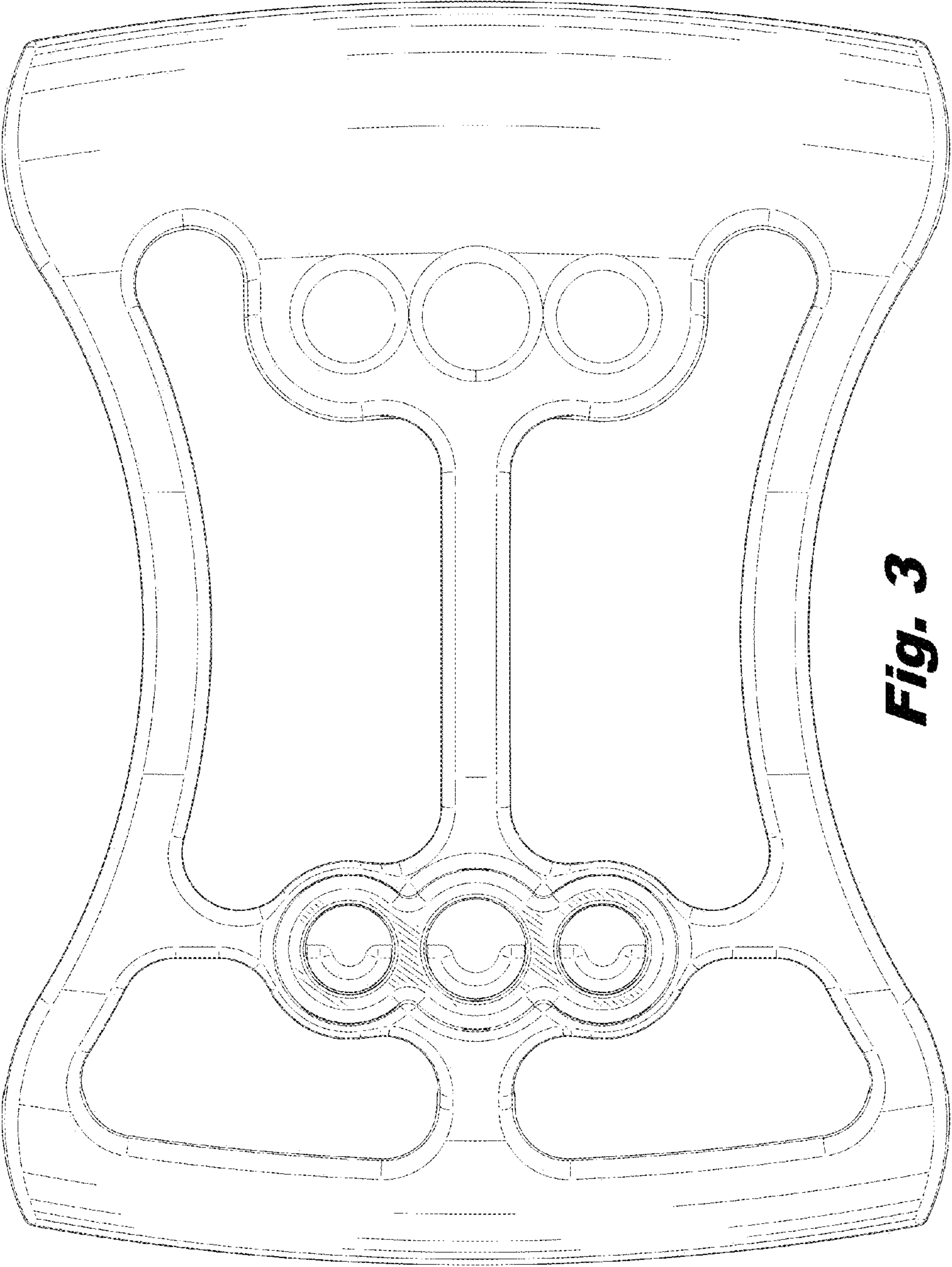


**Fig. 1**

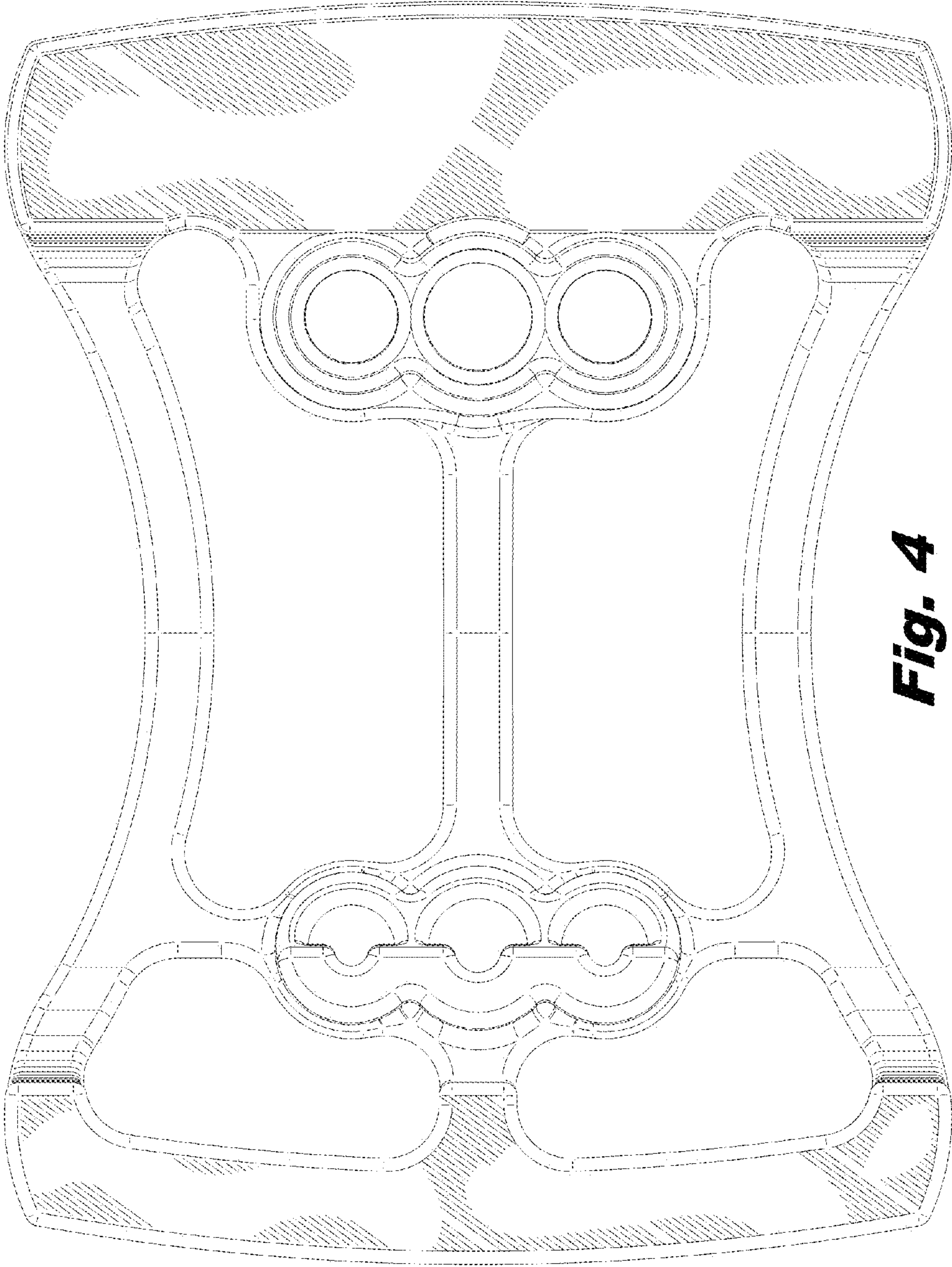




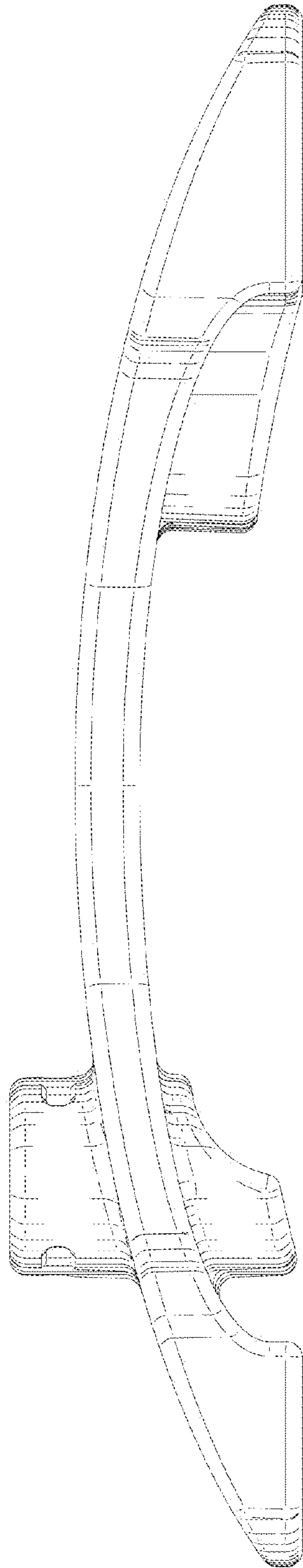
**Fig. 2**



**Fig. 3**

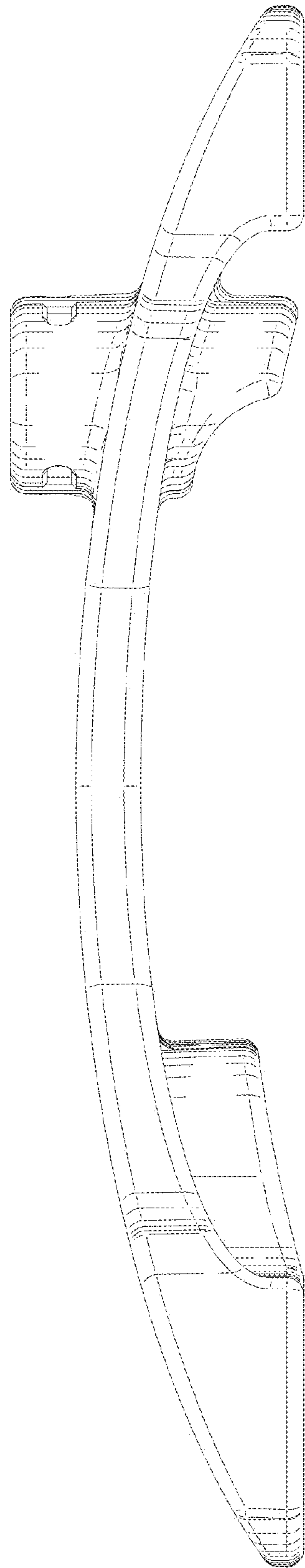


**Fig. 4**



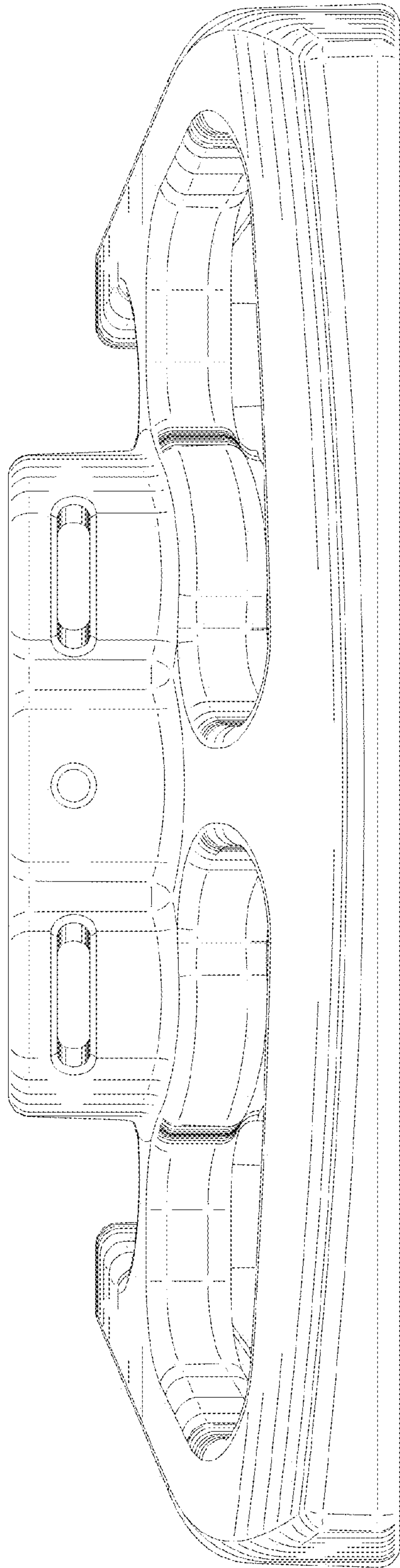
**Fig. 5**



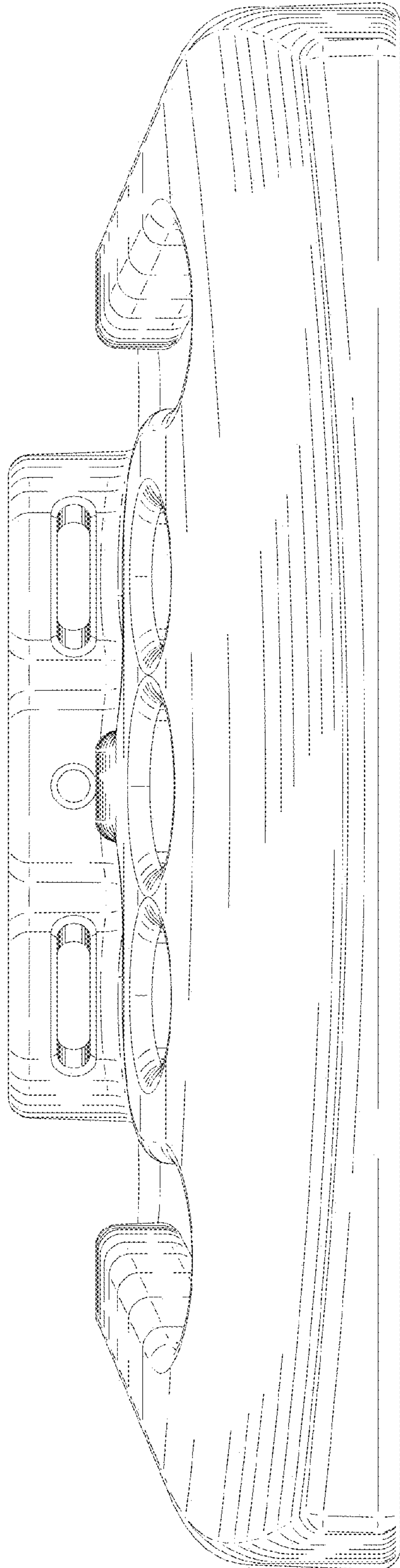


**Fig. 6**





**Fig. 7**



**Fig. 8**