



US00D758155S

(12) **United States Design Patent**
Kruzel

(10) **Patent No.:** **US D758,155 S**
(45) **Date of Patent:** **** Jun. 7, 2016**

(54) **CABLE TIE TOOL**
(71) Applicant: **Panduit Corp.**, Tinley Park, IL (US)
(72) Inventor: **Mateusz Kruzel**, Orland Park, IL (US)
(73) Assignee: **Panduit Corp.**, Tinley Park, IL (US)
(**) Term: **14 Years**
(21) Appl. No.: **29/517,523**
(22) Filed: **Feb. 13, 2015**
(51) **LOC (10) Cl.** **08-05**
(52) **U.S. Cl.**
USPC **D8/51; D8/44**
(58) **Field of Classification Search**
USPC D8/4, 5, 44, 51-60
CPC .. B65B 13/027; B65B 13/022; B65B 13/025;
B65B 13/327
See application file for complete search history.

7,210,506 B2 * 5/2007 Magno, Jr. B23Q 17/00
140/123.6
7,216,679 B2 * 5/2007 Magno, Jr. B65B 59/04
140/123.6
D543,811 S * 6/2007 Lueschen D8/44
7,231,944 B2 * 6/2007 Magno, Jr. B65B 13/027
140/123.6
D547,626 S * 7/2007 Lueschen D8/44
7,299,830 B2 * 11/2007 Levin B65B 13/027
140/123.6
D692,738 S * 11/2013 Dyer D8/44
8,955,556 B2 * 2/2015 Myers B26D 7/08
140/123.6
2013/0167698 A1 7/2013 Dyer
2013/0167699 A1 7/2013 Dyer
2013/0167969 A1 7/2013 Myers et al.
2013/0167970 A1 7/2013 Dyer

* cited by examiner

Primary Examiner — Deanna L Pratt
(74) *Attorney, Agent, or Firm* — Christopher S. Clancy;
James H. Williams; Aimee E. McVady

(57) **CLAIM**
The ornamental design for a cable tie tool, as shown and described.

(56) **References Cited**

U.S. PATENT DOCUMENTS

3,433,275 A 3/1969 Eppler
5,101,693 A * 4/1992 Chambers H02G 1/1212
81/9.41
5,492,156 A 2/1996 Dyer et al.
5,832,964 A 11/1998 Joshi
5,921,290 A * 7/1999 Dyer B65B 13/027
140/123.6
D430,781 S * 9/2000 Hillegonds D8/44
6,206,053 B1 * 3/2001 Hillegonds B65B 13/027
140/123.6
D473,773 S * 4/2003 Hillegonds D8/68
D491,430 S * 6/2004 Magno, Jr. D8/44
6,840,289 B2 * 1/2005 Hillegonds B65B 27/10
140/123.6
7,185,680 B2 * 3/2007 Magno, Jr. B65B 13/027
140/123.6
D541,610 S * 5/2007 Segroves D8/51

DESCRIPTION

FIG. 1 is a front left side perspective view of a cable tie tool;
FIG. 2 is a rear left side perspective view thereof;
FIG. 3 is a left side elevation view thereof;
FIG. 4 is a front right side perspective view thereof;
FIG. 5 is a rear right side perspective view thereof;
FIG. 6 is a right side elevation view thereof;
FIG. 7 is a top plan view thereof;
FIG. 8 is a bottom plan view thereof;
FIG. 9 is a front elevation view thereof; and,
FIG. 10 is a rear elevation view thereof.
The broken lines illustrate portions of the cable tie tool that form no part of the claimed design.

1 Claim, 10 Drawing Sheets

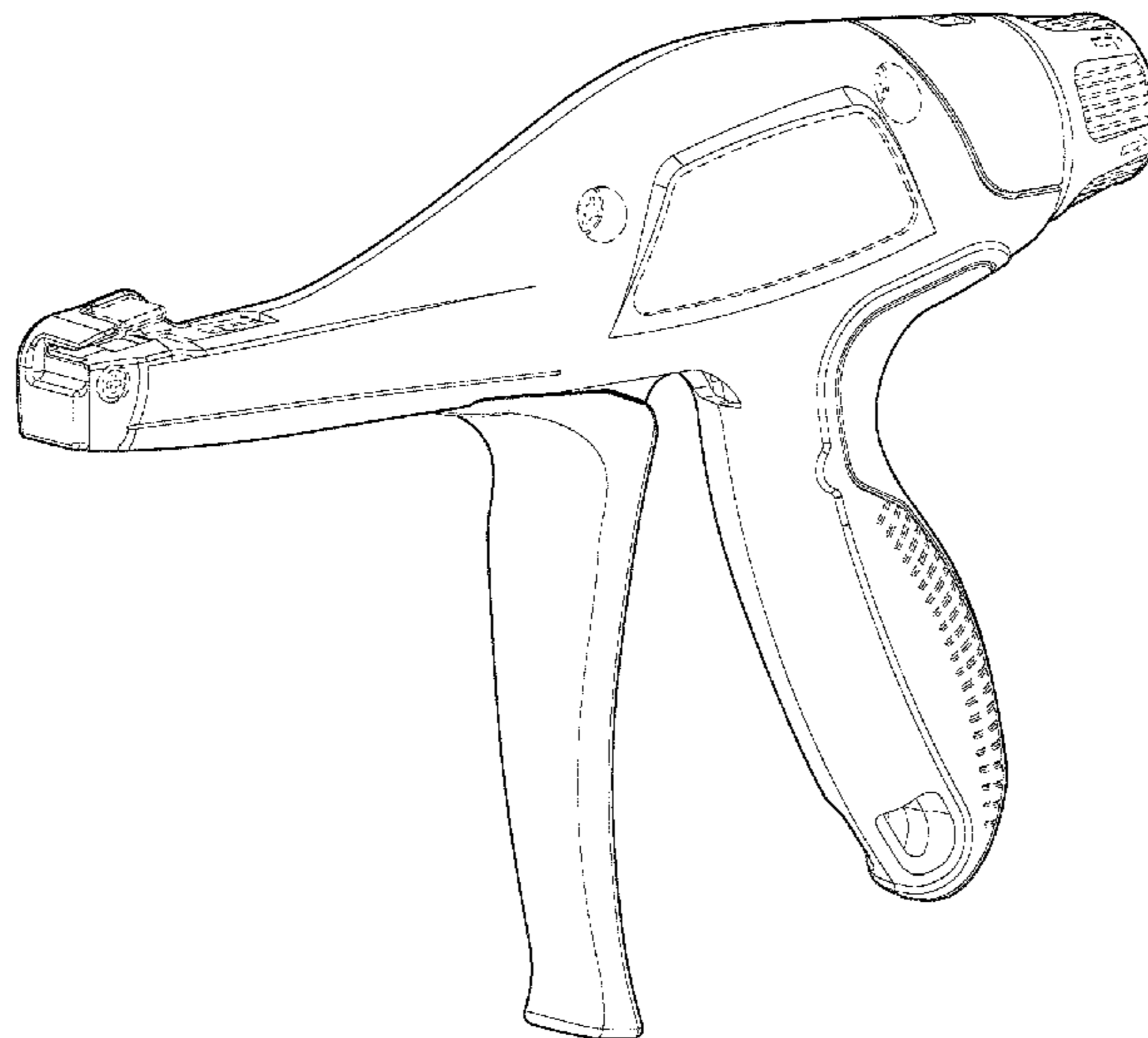

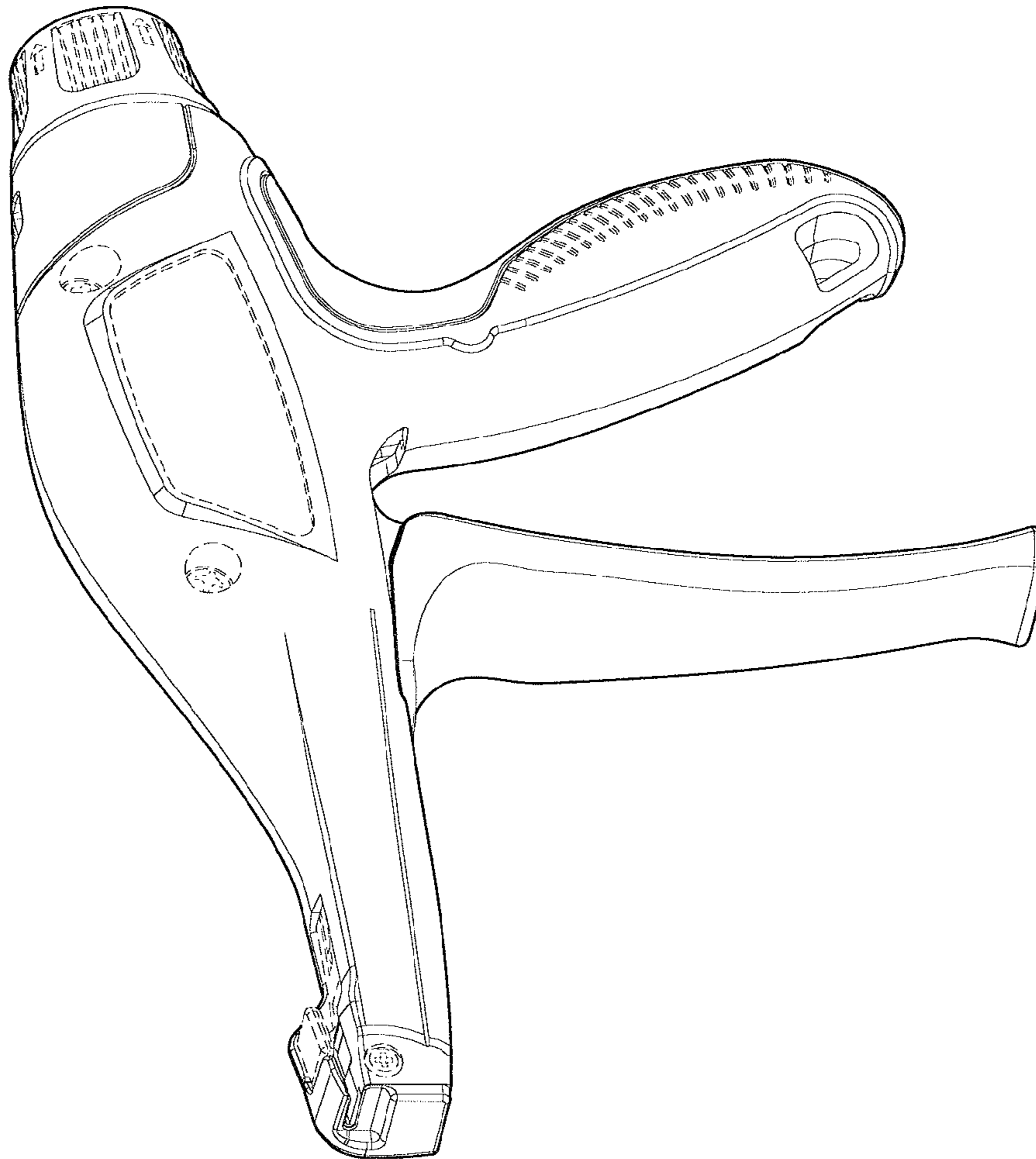

FIG. 1

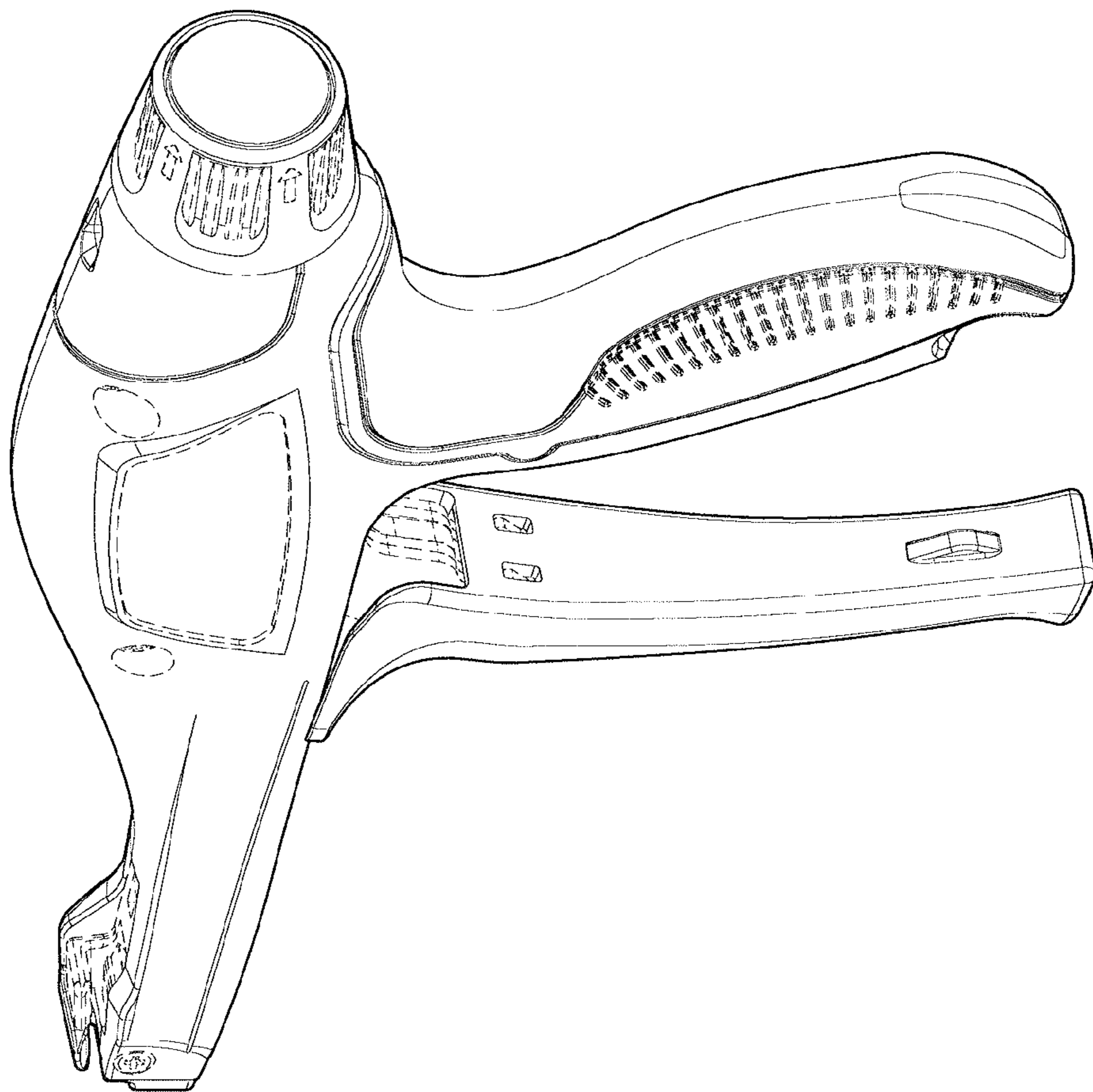

FIG.2

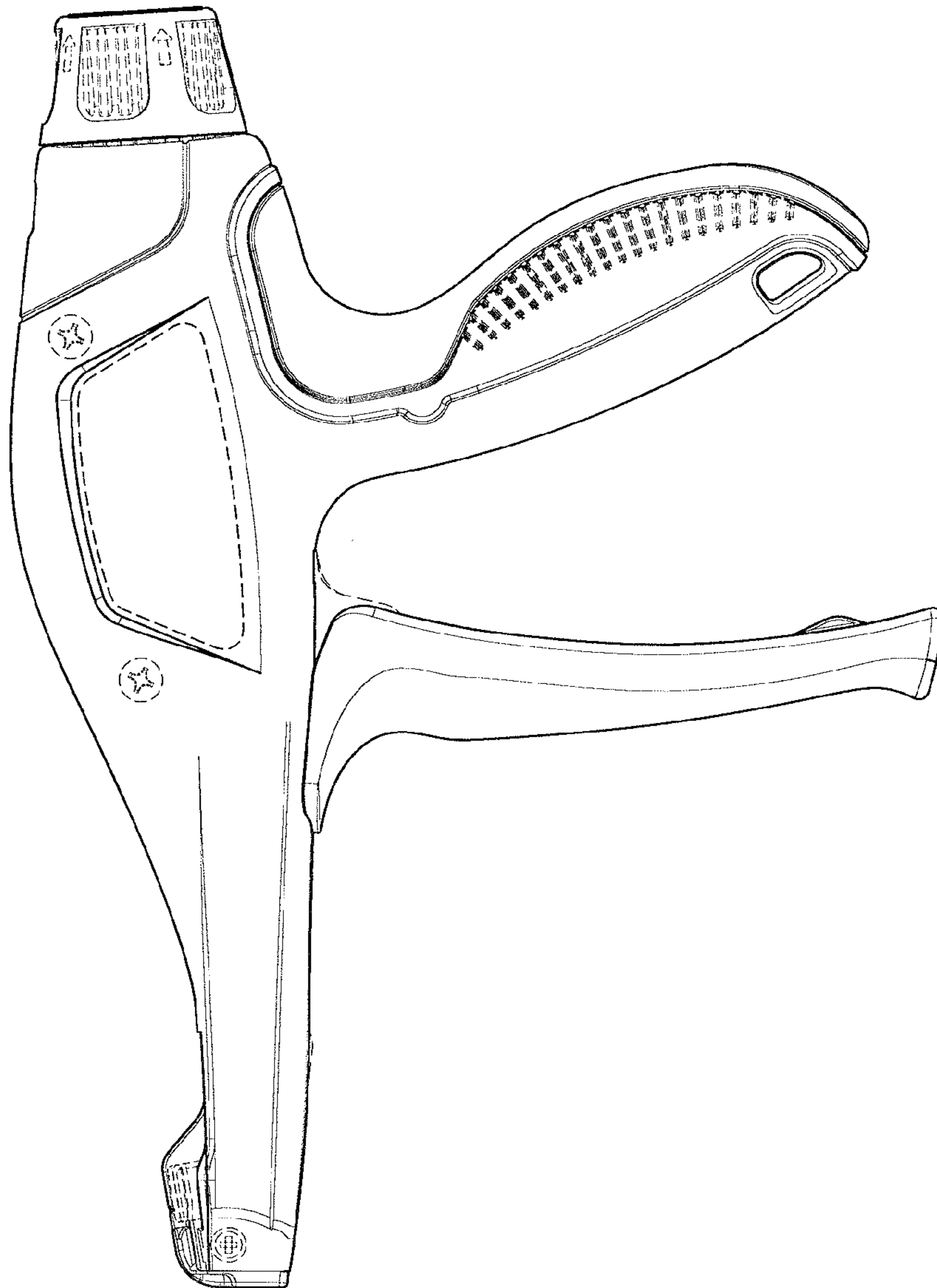

FIG. 3

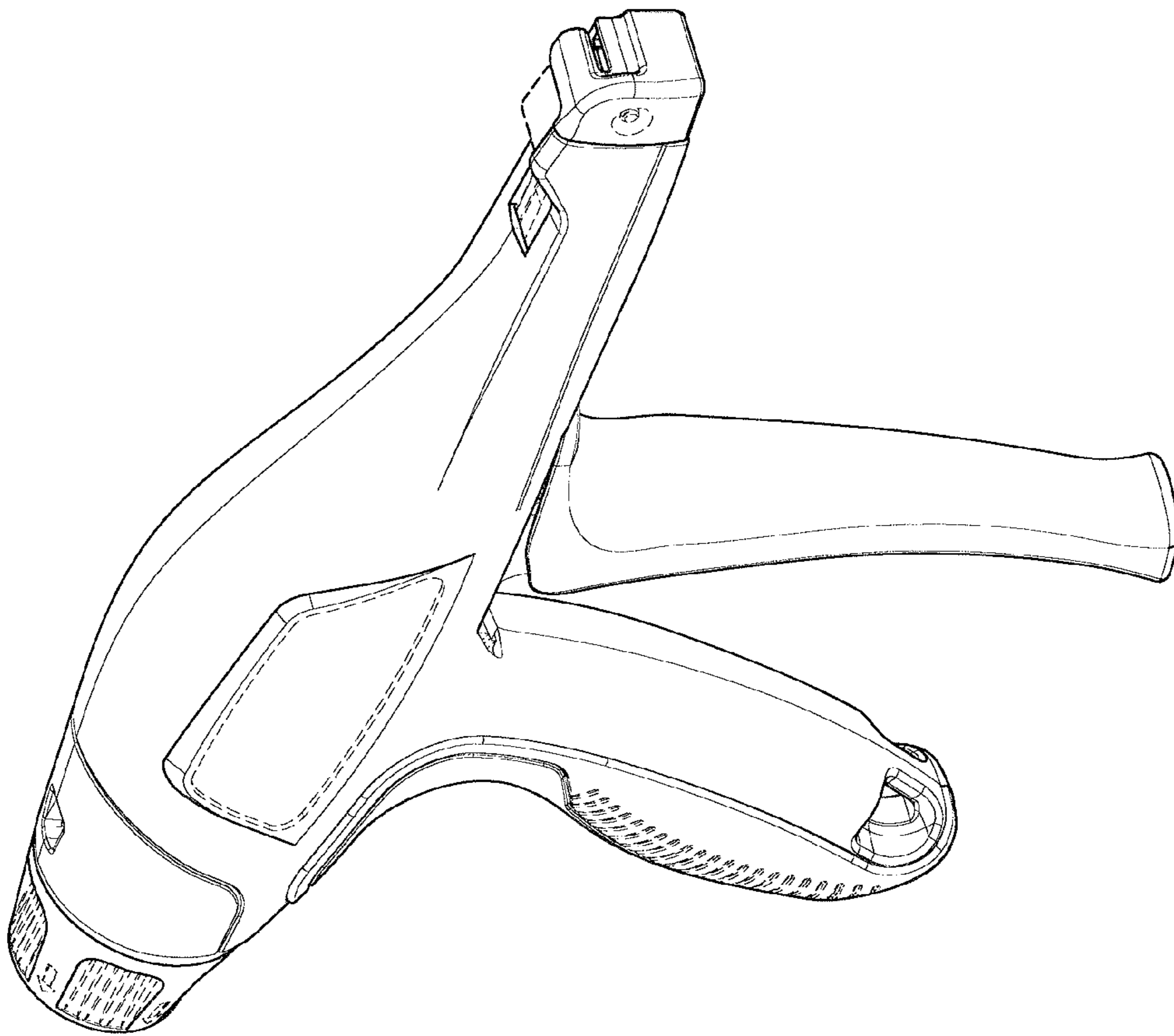

FIG.4

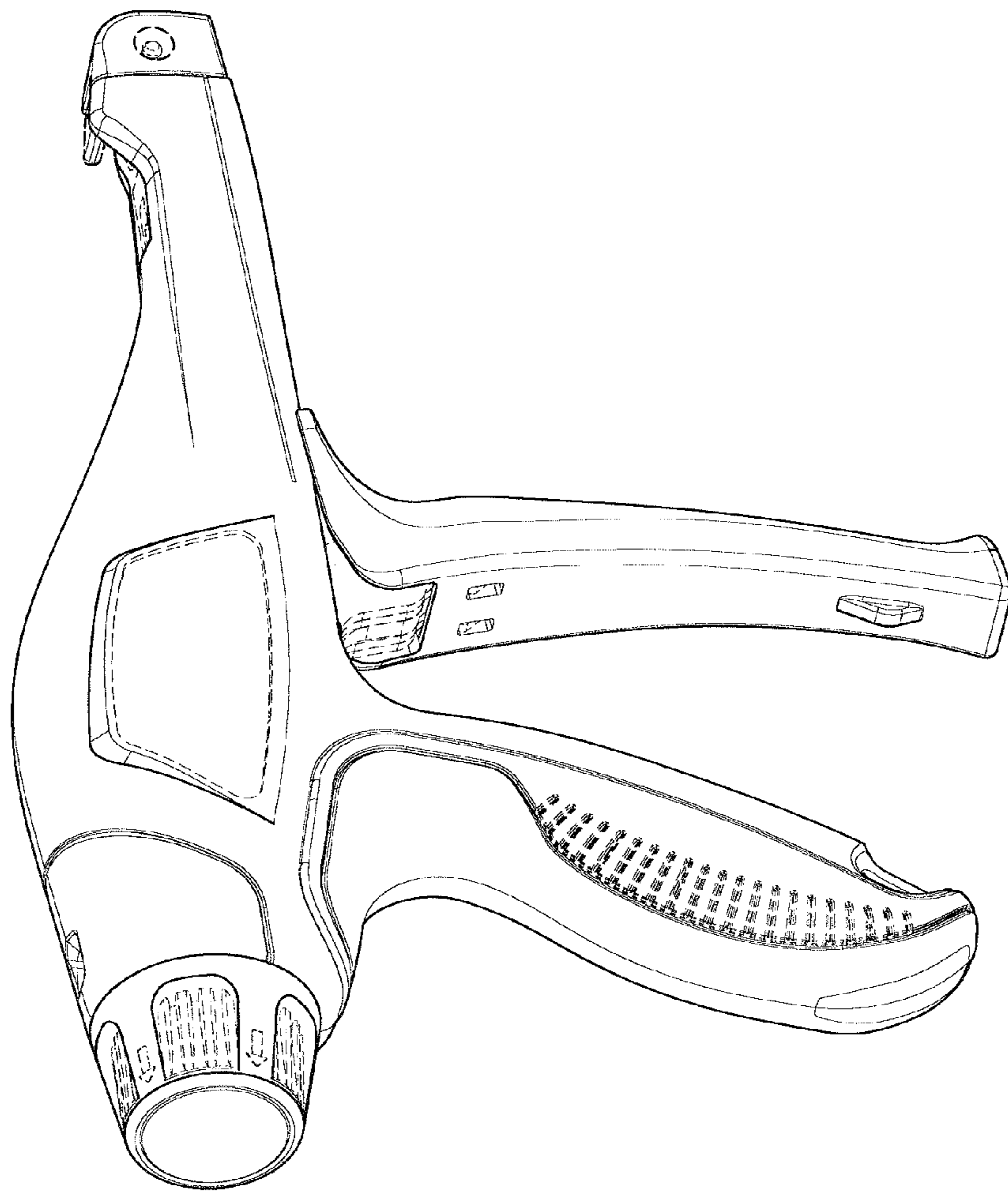

FIG. 5

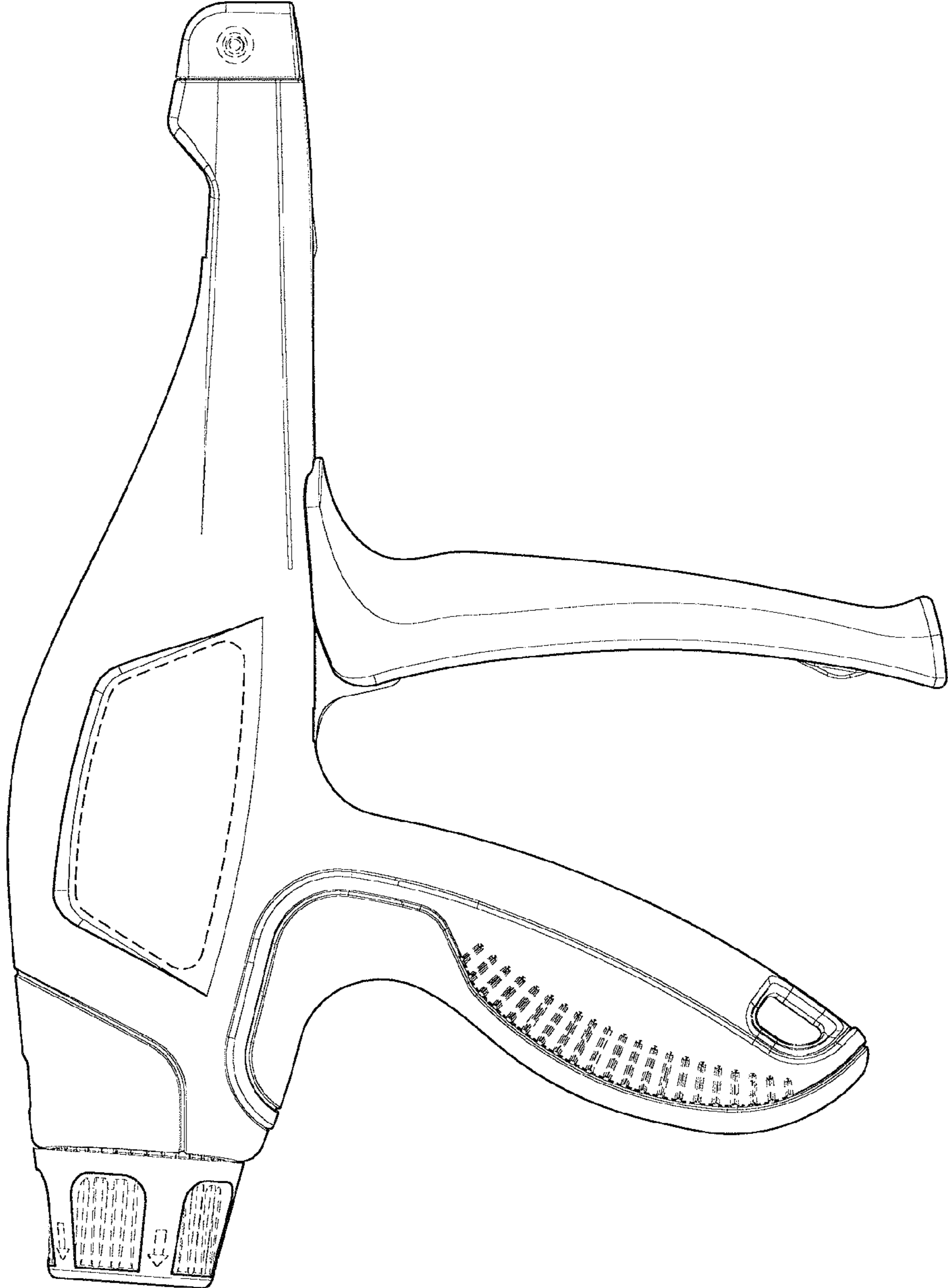

FIG.6

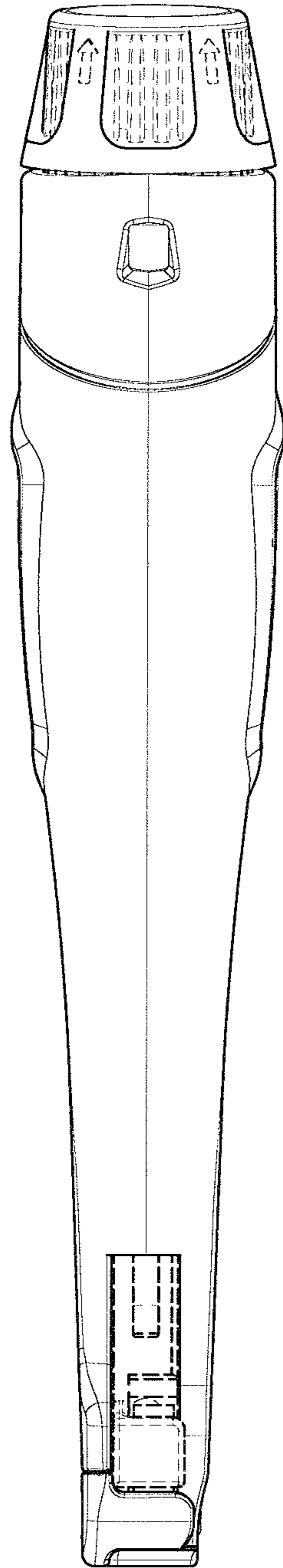

FIG. 7

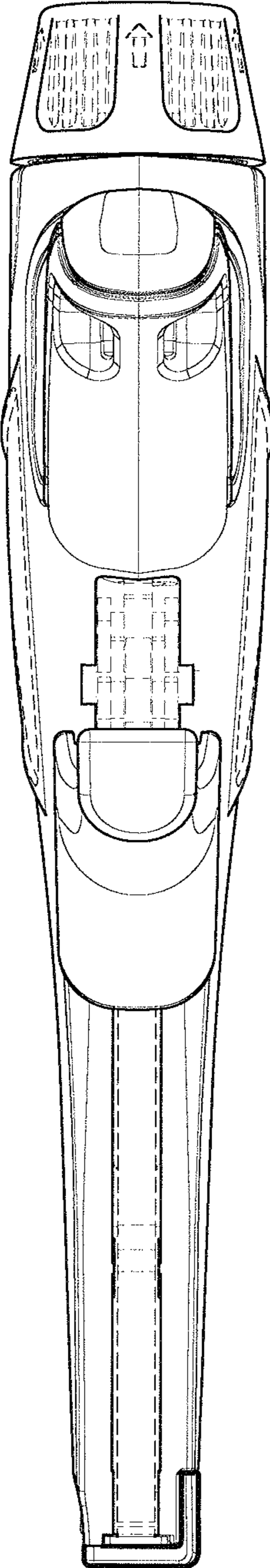

FIG. 8

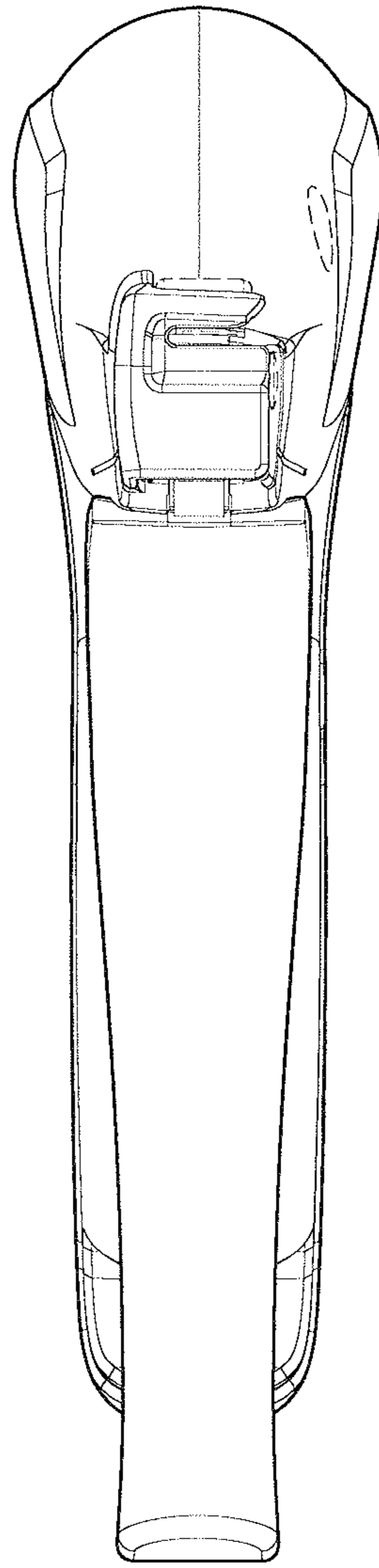

FIG.9

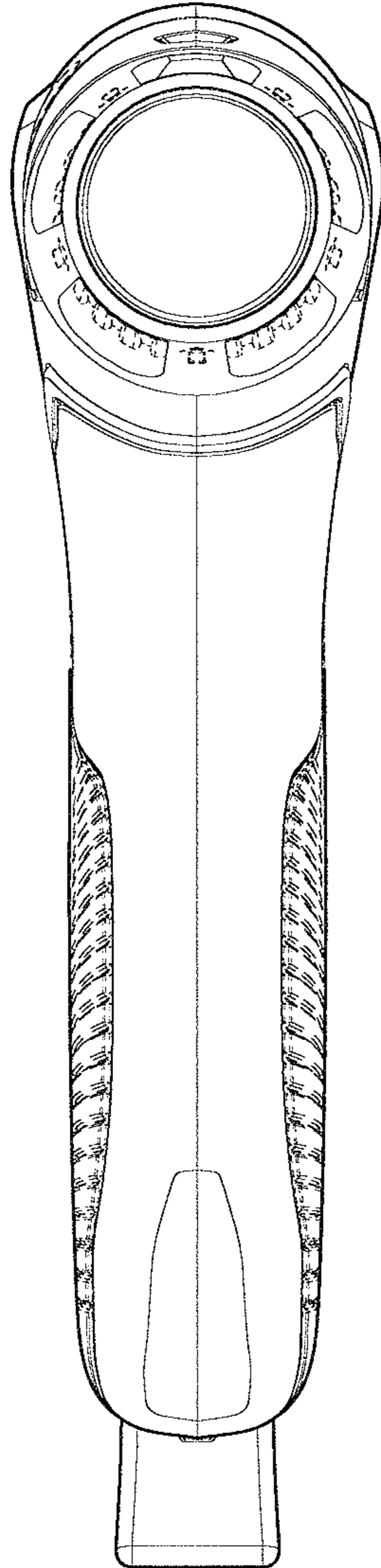

FIG.10