



US00D758081S

(12) **United States Design Patent**  
**Harmoush**

(10) **Patent No.:** **US D758,081 S**  
(45) **Date of Patent:** **\*\* Jun. 7, 2016**

- (54) **TOOTHBRUSH HEAD**
- (71) Applicant: **Michael Harmoush**, Tampa, FL (US)
- (72) Inventor: **Michael Harmoush**, Tampa, FL (US)
- (\*\*) Term: **14 Years**
- (21) Appl. No.: **29/526,040**
- (22) Filed: **May 5, 2015**
- (51) **LOC (10) Cl.** ..... **04-02**
- (52) **U.S. Cl.**  
USPC ..... **D4/105**
- (58) **Field of Classification Search**  
USPC ..... D4/100-102, 104-118, 124-125,  
D4/127-132, 136, 138  
CPC ..... A46B 5/00; A46B 5/0004; A46B 5/0008;  
A46B 5/0012; A46B 5/002; A46B 5/0095;  
A46B 9/04; A46B 11/0006; A46B 2200/1066;  
A61B 17/24; A61C 17/16  
See application file for complete search history.

D364,740 S *	12/1995	Loew	.....	D4/104
D399,349 S *	10/1998	Barth	.....	D4/106
D424,809 S *	5/2000	Bernard	.....	D4/105
D489,533 S *	5/2004	Yost	.....	D4/106
RE39,185 E *	7/2006	Noe	.....	A46B 9/005 15/104.94
D544,212 S *	6/2007	Hsieh	.....	D4/114
D561,475 S *	2/2008	Wang	.....	D4/101
8,955,528 B1 *	2/2015	Escobar	.....	A61Q 11/02 132/308

\* cited by examiner

*Primary Examiner* — Catheri Oliver-Garcia  
*Assistant Examiner* — Rebekah Caruso  
(74) *Attorney, Agent, or Firm* — Gulf Coast Intellectual Property Group

(57) **CLAIM**  
The ornamental design for a toothbrush head, as shown and described.

**DESCRIPTION**

FIG. 1 is a perspective view of the present invention;  
FIG. 2 is a front view thereof;  
FIG. 3 is a rear view thereof;  
FIG. 4 is a left side view thereof;  
FIG. 5 is a right side view thereof;  
FIG. 6 is a top view thereof; and,  
FIG. 7 is a bottom view thereof.  
The broken lines shown in the drawings illustrate environment and do not form any part of the claimed design.

**1 Claim, 3 Drawing Sheets**

- (56) **References Cited**  
U.S. PATENT DOCUMENTS  
D75,971 S \* 8/1928 Faubert ..... D4/106  
2,236,034 A \* 3/1941 Luce ..... A46B 9/04  
15/106  
2,807,820 A \* 10/1957 Dinhofer ..... A46B 7/04  
15/110  
5,331,704 A \* 7/1994 Rosen ..... A46B 9/02  
15/106  
5,465,449 A \* 11/1995 Lewkowicz ..... A46B 5/02  
15/106

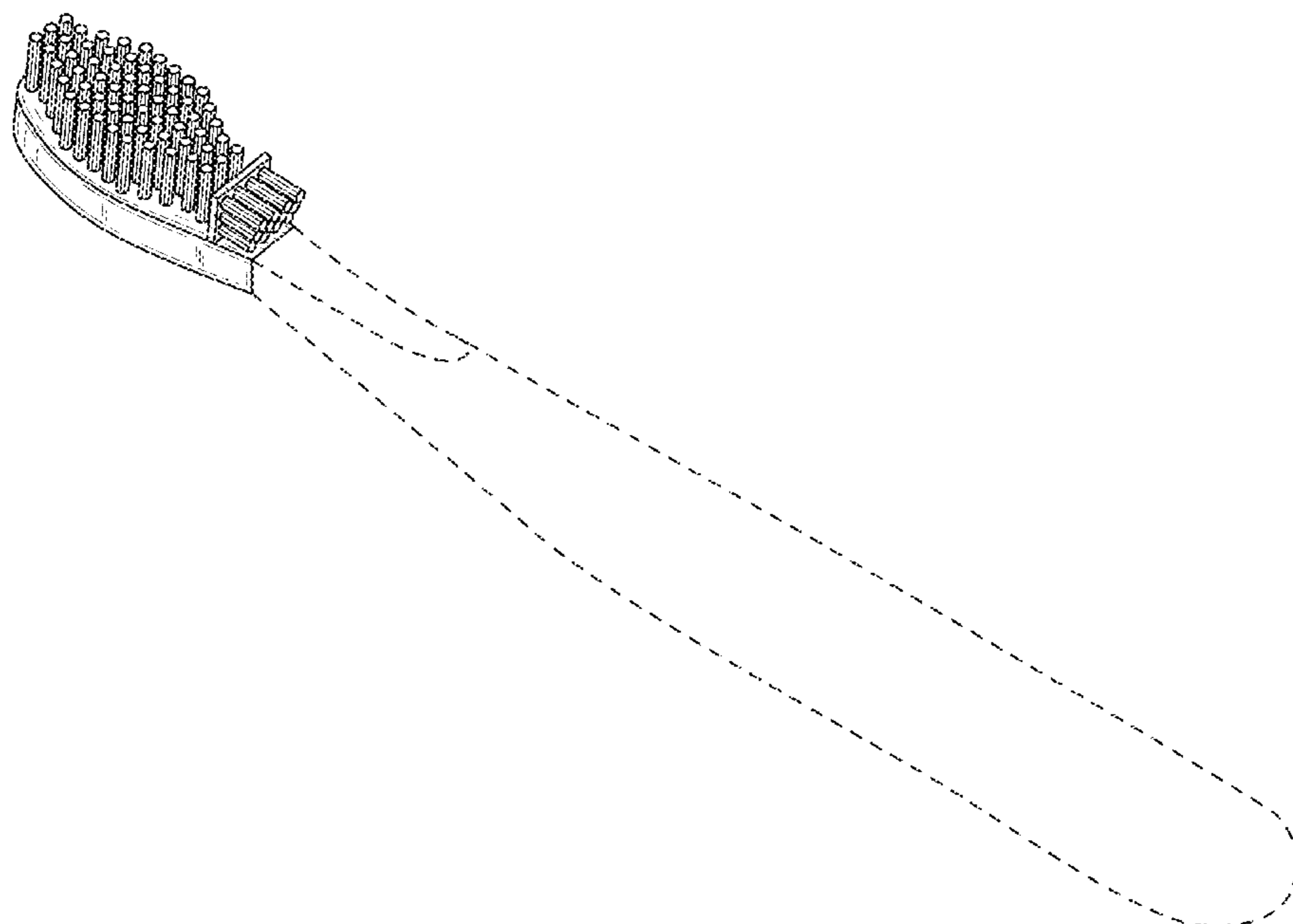

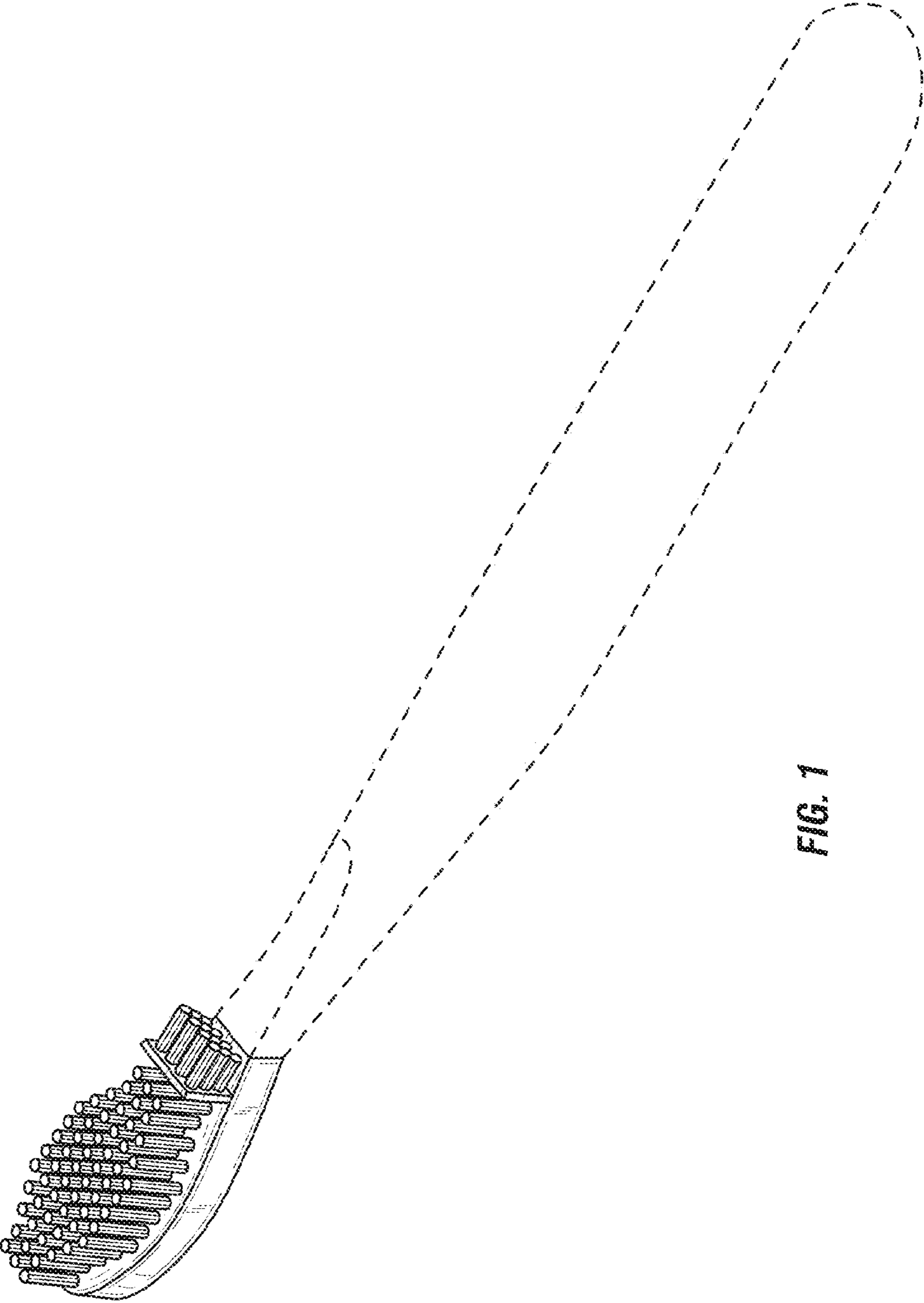

FIG. 1

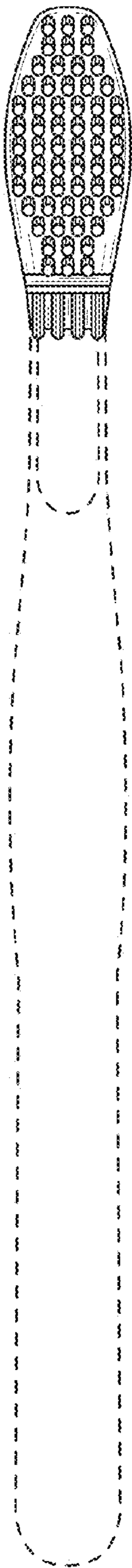

FIG. 2

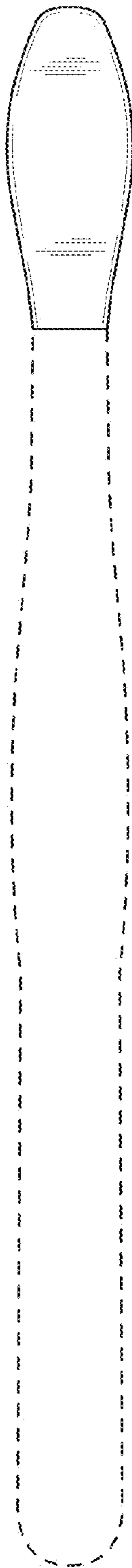

FIG. 3

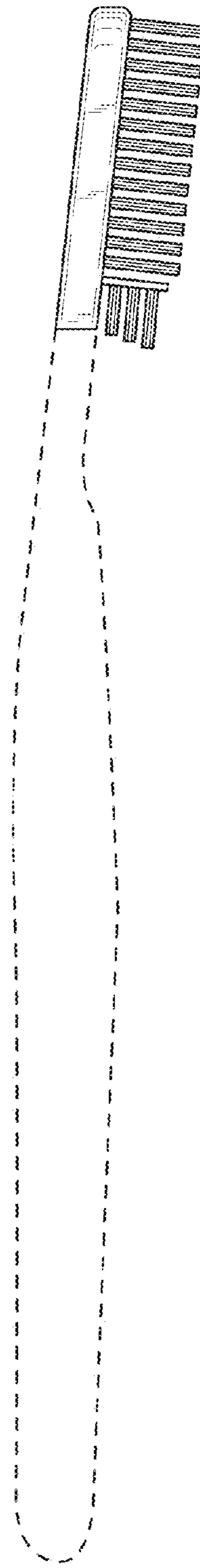

FIG. 4

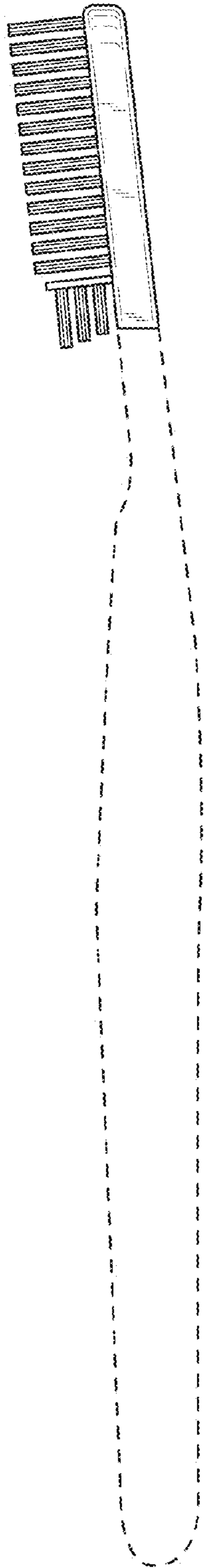

FIG. 5

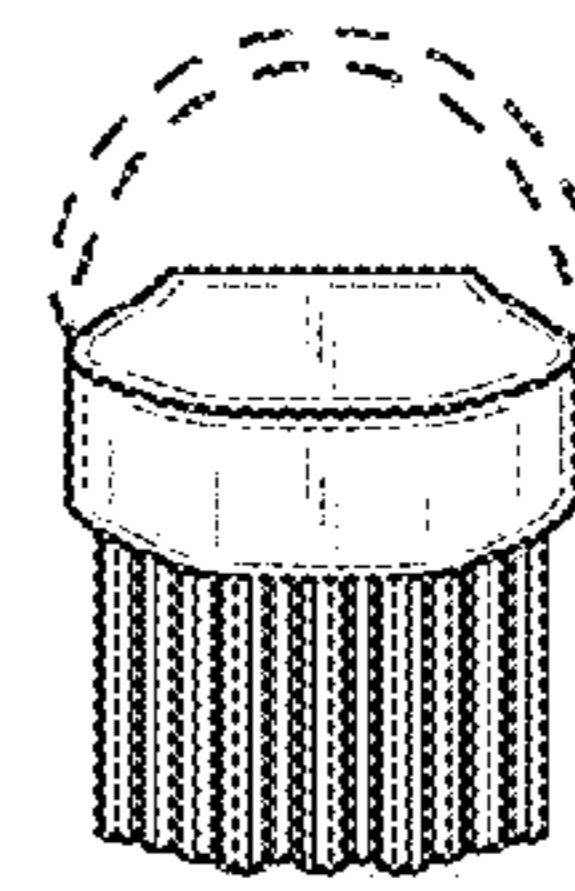

FIG. 6

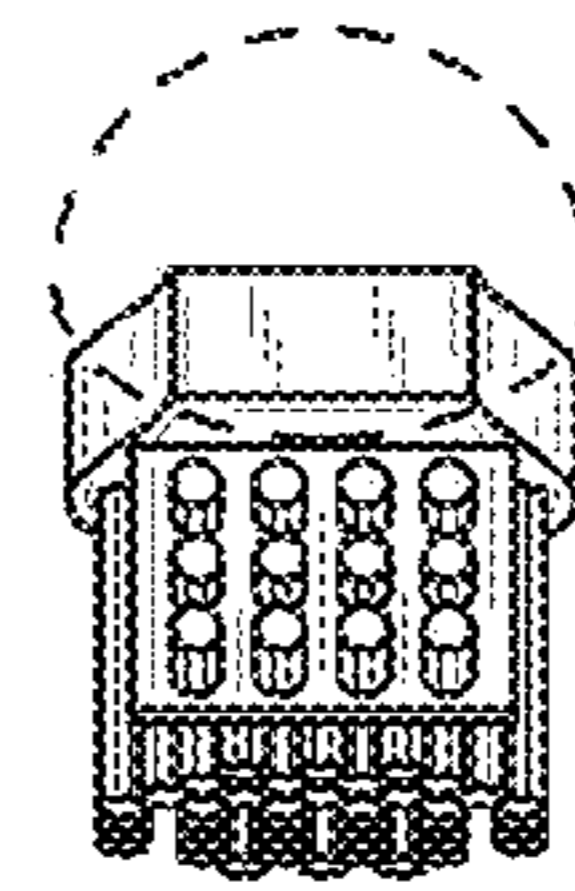

FIG. 7