



US00D758026S

(12) **United States Design Patent**  
**Choi**

(10) **Patent No.:** **US D758,026 S**

(45) **Date of Patent:** **\*\* May 31, 2016**

(54) **DISHWASHER**

(71) Applicant: **Samsung Electronics Co., Ltd.**,  
Suwon-si, Gyeonggi-do (KR)

(72) Inventor: **Woo-Joo Choi**, Anyang-si (KR)

(73) Assignee: **SAMSUNG ELECTRONICS CO., LTD.** (KR)

(\*\*) Term: **14 Years**

(21) Appl. No.: **29/509,844**

(22) Filed: **Nov. 21, 2014**

(30) **Foreign Application Priority Data**

May 21, 2014 (KR) ..... 30-2014-0025050

(51) **LOC (10) Cl.** ..... **15-05**

(52) **U.S. Cl.**  
USPC ..... **D32/3**

(58) **Field of Classification Search**  
USPC ..... D32/2-3; D14/486, 489  
CPC ... A47L 15/4285; A47L 15/42; A47L 15/481;  
A47L 15/507; B08B 3/024  
See application file for complete search history.

(56) **References Cited**

**U.S. PATENT DOCUMENTS**

D253,770	S	*	12/1979	Flynn	.....	D32/3
D320,489	S	*	10/1991	Marks	.....	D32/3
D373,860	S	*	9/1996	Manke	.....	D32/3
D385,069	S	*	10/1997	Hughes	.....	D32/3
D385,071	S	*	10/1997	Hughes	.....	D32/3
D424,257	S	*	5/2000	Umeda	.....	D32/2
D591,464	S	*	4/2009	Green	.....	D32/3
D593,126	S	*	5/2009	Danton	.....	D14/489
D618,406	S	*	6/2010	Ott	.....	D32/3
D625,475	S	*	10/2010	Kim	.....	D32/3
D627,939	S	*	11/2010	Kim	.....	D32/2
D642,751	S	*	8/2011	Jenkins	.....	D32/3
D645,621	S	*	9/2011	Jenkins	.....	D32/3

D653,821	S	*	2/2012	Grobleben	.....	D32/3
D656,946	S	*	4/2012	Judy	.....	D14/486
D667,838	S	*	9/2012	Magee	.....	D14/486
D683,748	S	*	6/2013	Chutani	.....	D14/487
D689,069	S	*	9/2013	Edwards	.....	D14/486
D689,088	S	*	9/2013	Yang	.....	D14/489
D689,515	S	*	9/2013	Yang	.....	D14/489
D693,069	S	*	11/2013	Grobleben	.....	D32/3
D701,359	S	*	3/2014	Eng	.....	D32/3
D702,899	S	*	4/2014	Eng	.....	D32/3
D706,821	S	*	6/2014	Park	.....	D14/489
D712,926	S	*	9/2014	Meegan	.....	D14/489
D733,370	S	*	6/2015	Roberson	.....	D32/3
D733,980	S	*	7/2015	Grobleben	.....	D32/3
D739,618	S	*	9/2015	Shoemaker	.....	D32/3
D744,176	S	*	11/2015	Roberson	.....	D32/3

(Continued)

*Primary Examiner* — T. Chase Nelson

*Assistant Examiner* — Michelle E Wilson

(74) *Attorney, Agent, or Firm* — Cantor Colburn LLP

(57) **CLAIM**

The ornamental design for a dishwasher, as shown and described.

**DESCRIPTION**

FIG. 1 is a perspective view of a dishwasher, showing my new design;

FIG. 2 is a front view thereof;

FIG. 3 is a rear view thereof;

FIG. 4 is a side view thereof;

FIG. 5 is a another side view thereof;

FIG. 6 is a top view thereof;

FIG. 7 is a bottom view thereof; and,

FIG. 8 is an enlarged view of the encircled portion shown in FIG. 2.

The broken lines are for environmental purpose only and form no part of the claimed design.

The dot-dash broken lines encircle portions of the claimed design that are illustrated in enlargements and form no part of the claimed design.

**1 Claim, 8 Drawing Sheets**

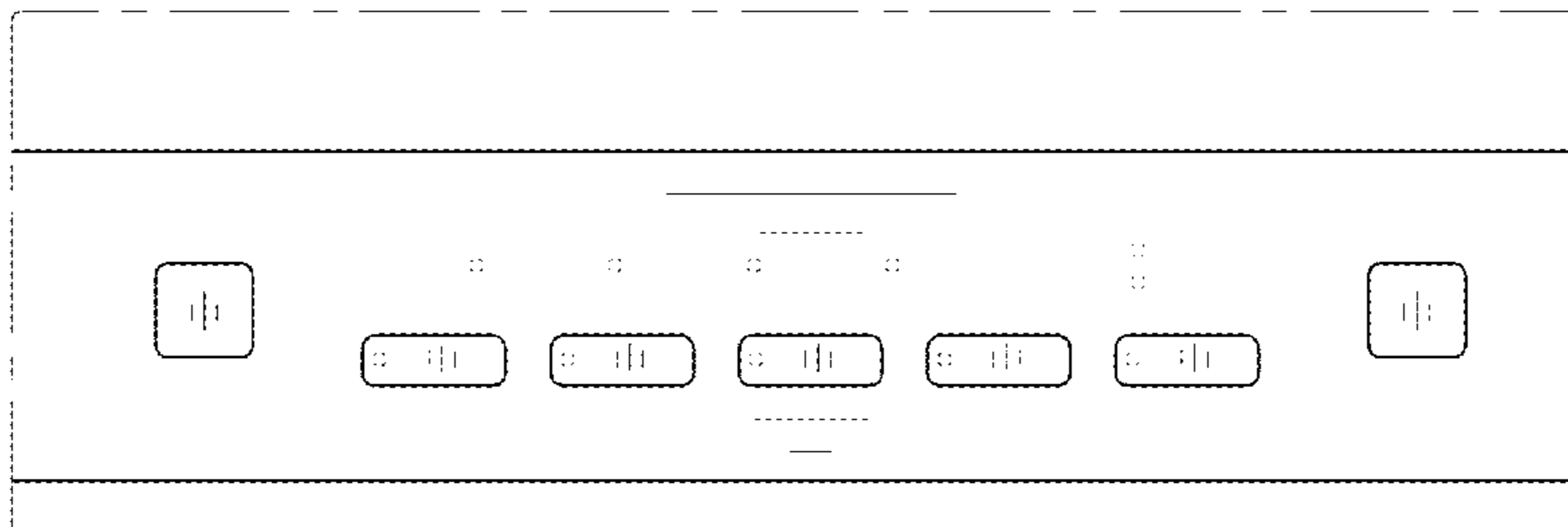

# US D758,026 S

Page 2

---

(56)

## References Cited

### U.S. PATENT DOCUMENTS

D745,753 S \* 12/2015 Roberson ..... D32/3  
2008/0072896 A1\* 3/2008 Setzer ..... A61M 16/00  
128/200.24

D745,751 S \* 12/2015 Roberson ..... D32/3 \* cited by examiner

FIG. 1

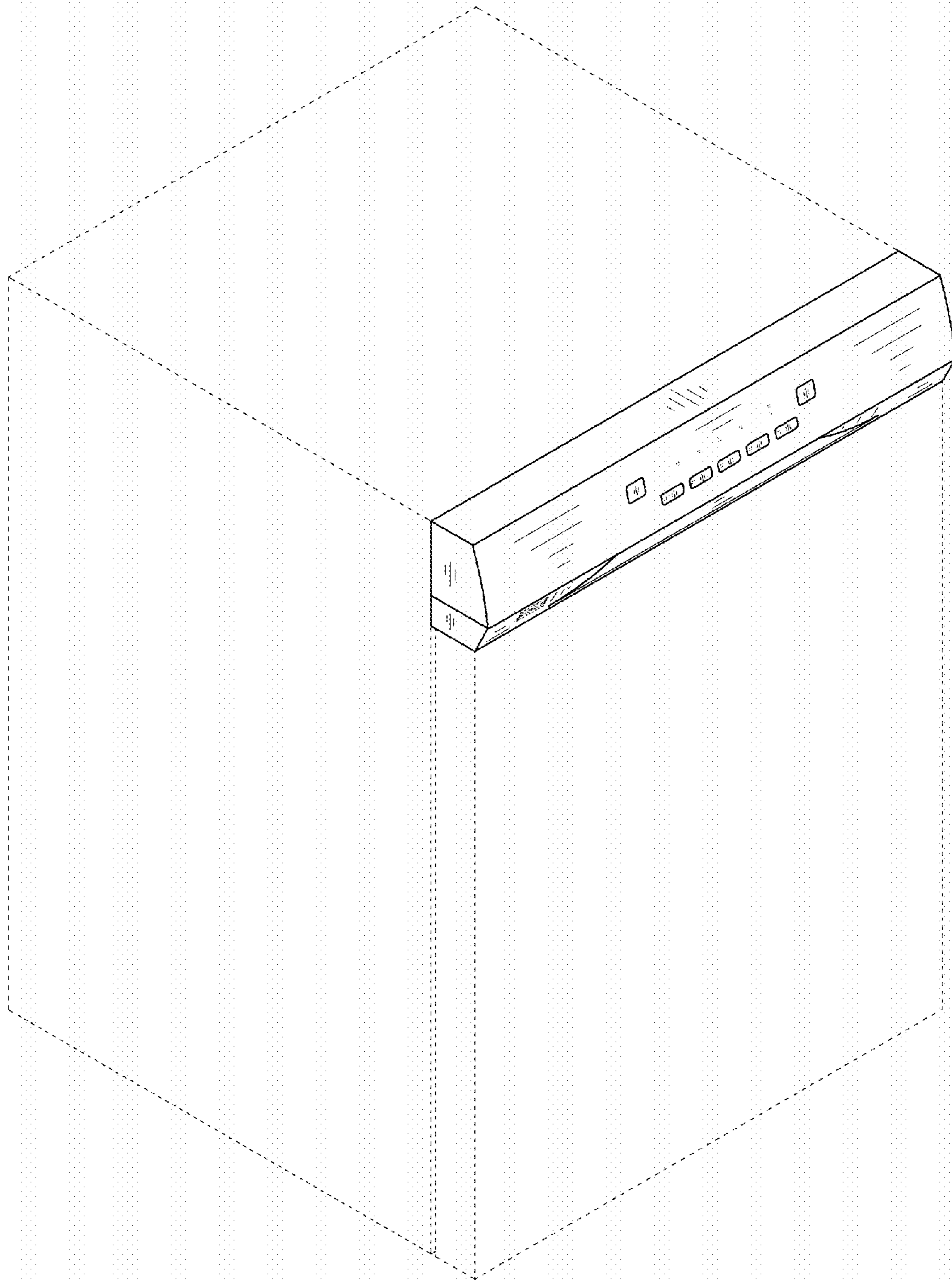

FIG. 2

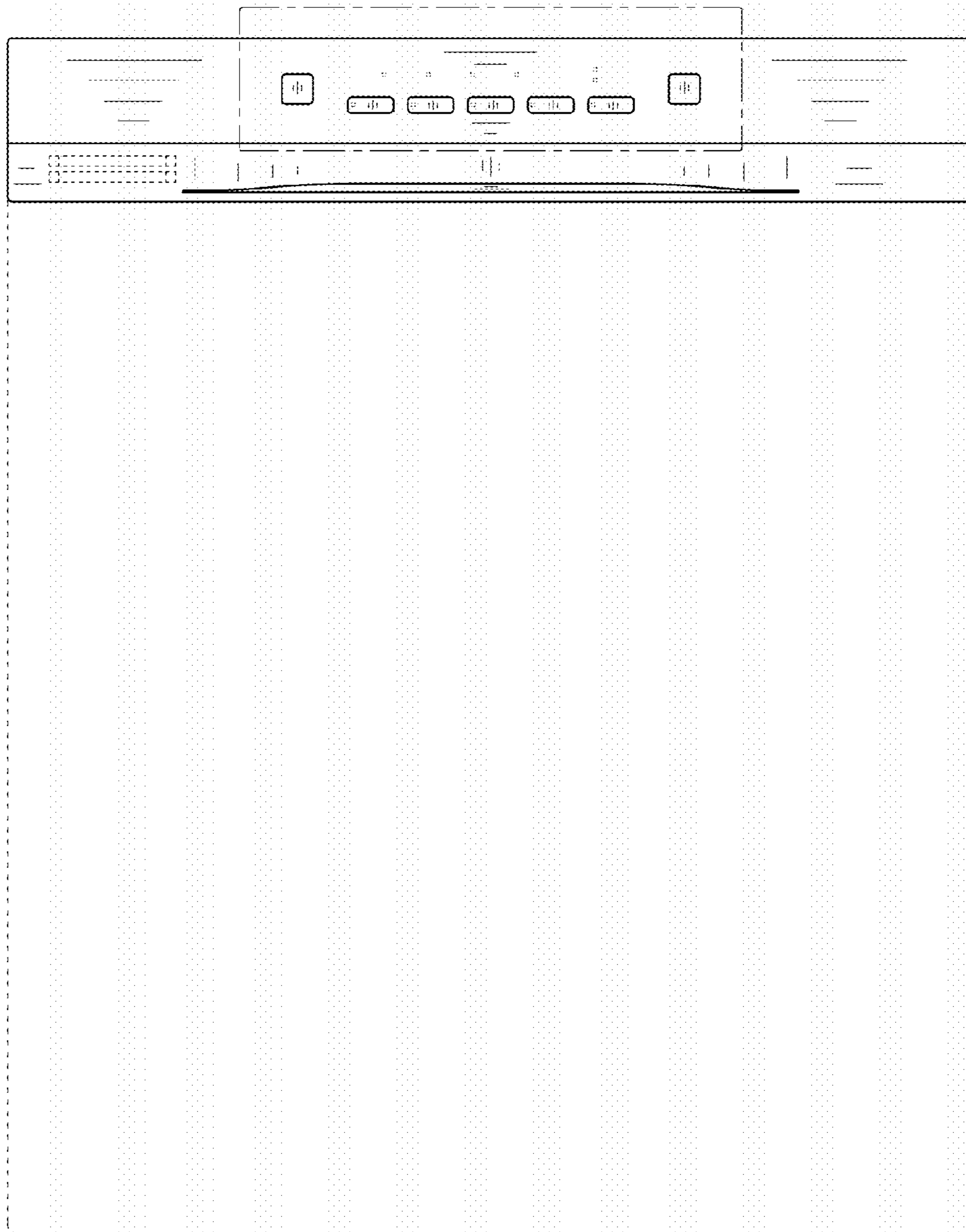

FIG. 3

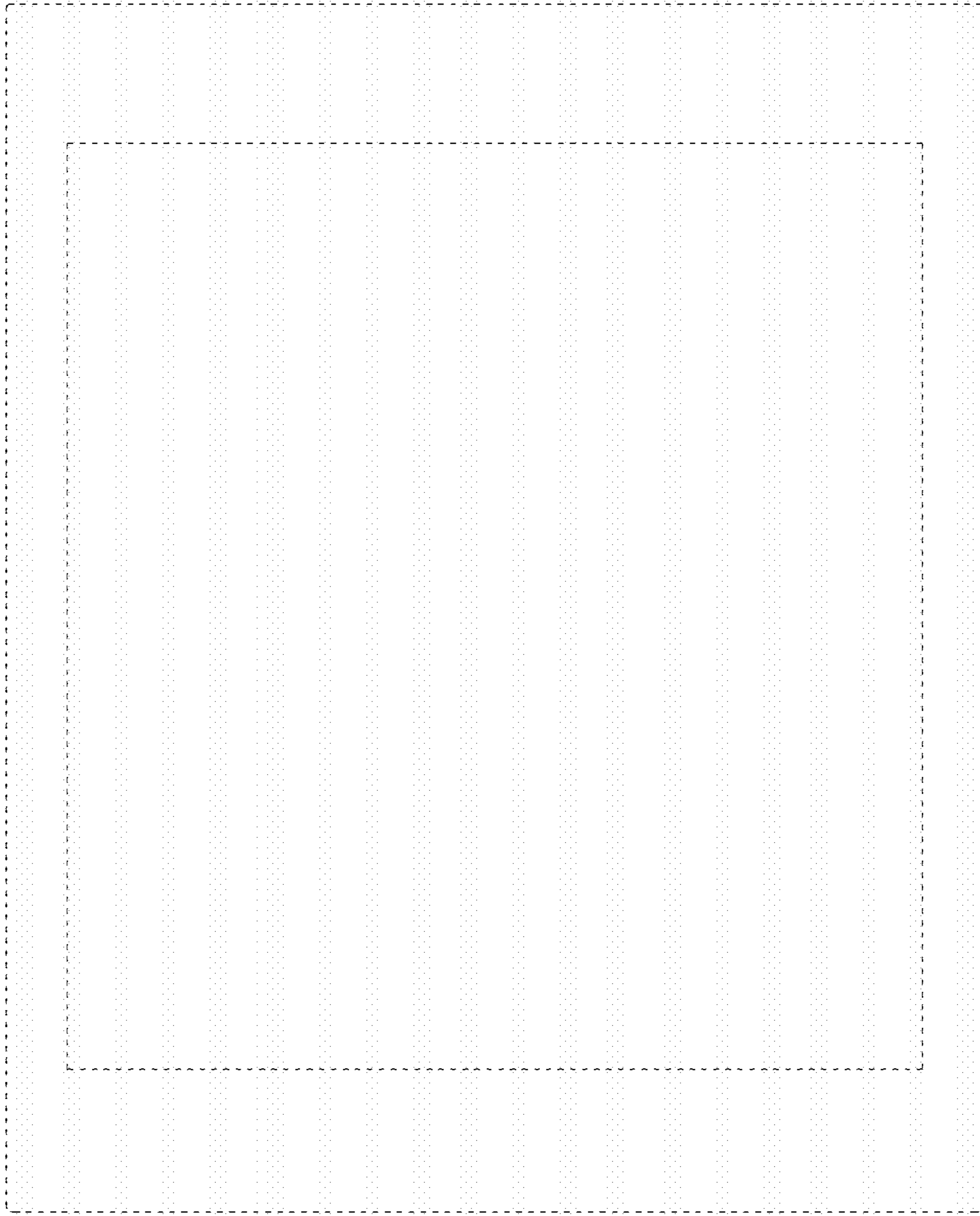

FIG. 4

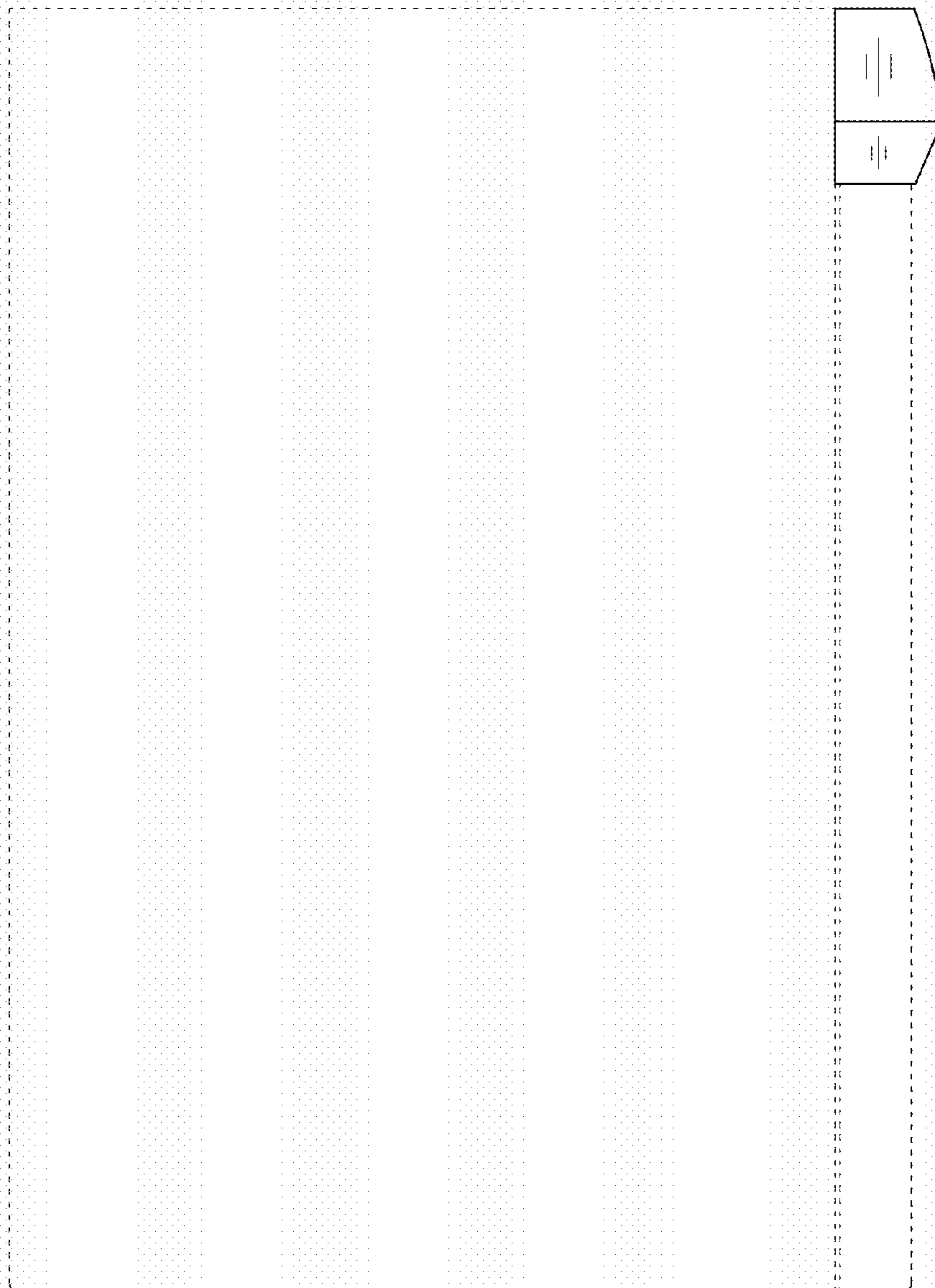

FIG. 5

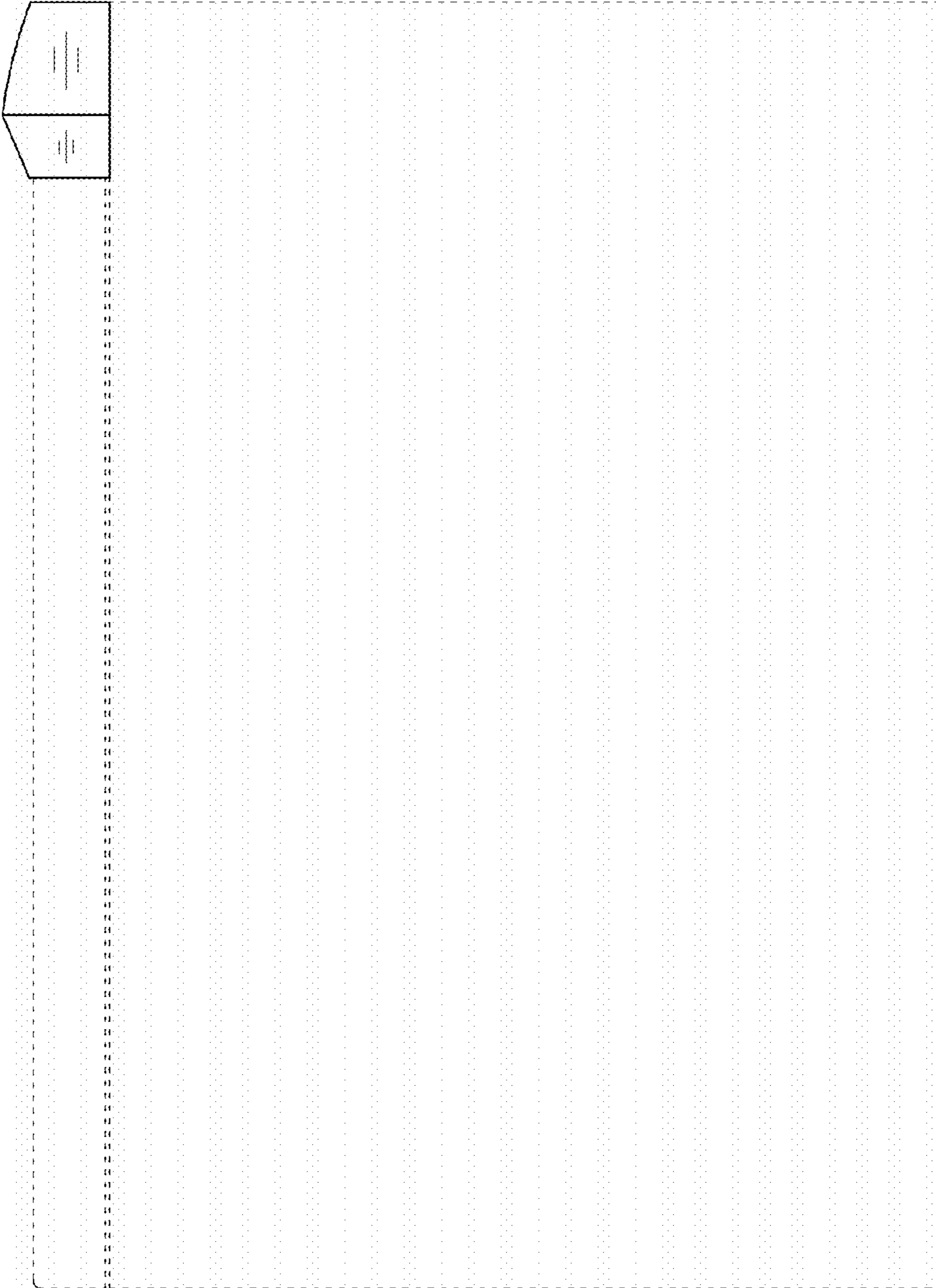

FIG. 6

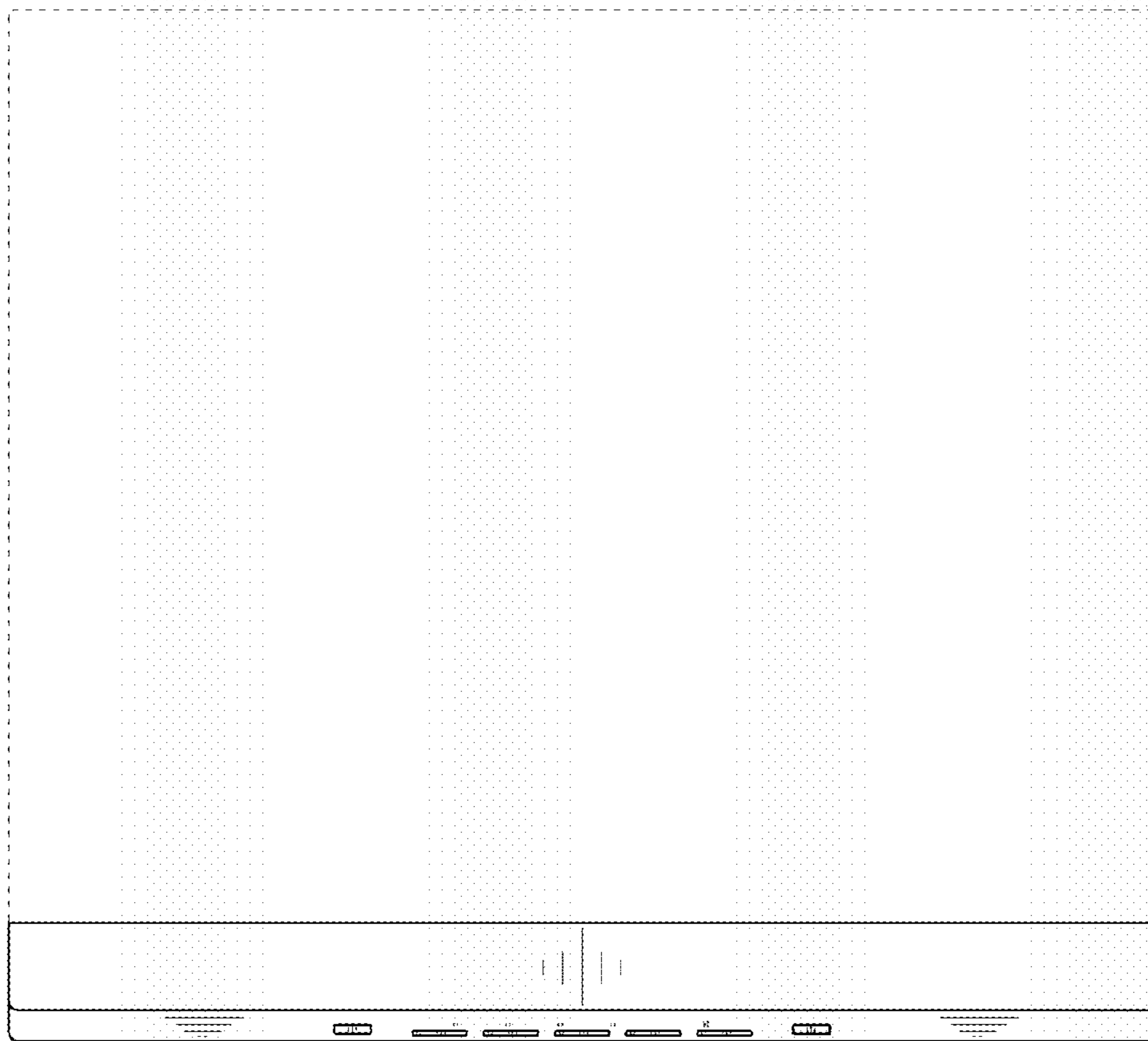



FIG. 7



FIG. 8

