



US00D758019S

(12) **United States Design Patent**
Takiguchi et al.

(10) **Patent No.:** **US D758,019 S**
(45) **Date of Patent:** **** May 31, 2016**

(54) **HAND DRYER**

(71) Applicant: **TOTO, Ltd.**, Kitakyushu-shi, Fukuoka (JP)

(72) Inventors: **Yusuke Takiguchi**, Kitakyushu (JP);
Masafumi Ishikawa, Kitakyushu (JP)

(73) Assignee: **TOTO, Ltd.**, Kitakyushu-shi, Fukuoka (JP)

(**) Term: **14 Years**

(21) Appl. No.: **29/487,570**

(22) Filed: **Apr. 10, 2014**

(30) **Foreign Application Priority Data**

Oct. 11, 2013 (JP) 2013-023751

(51) **LOC (10) Cl.** **28-03**

(52) **U.S. Cl.**
USPC **D28/54.1**; D32/8

(58) **Field of Classification Search**
USPC D32/8; D28/12, 54.1, 58; D23/357,
D23/361, 385; D6/601, 604; D21/803, 804,
D21/322, 352, 504, 505, 662; D14/188,
D14/204; D26/72, 88
CPC A47K 10/48
See application file for complete search history.

(56) **References Cited**

U.S. PATENT DOCUMENTS

D304,101 S * 10/1989 Mango D28/54.1
D309,037 S * 7/1990 Morrow D28/54.1
D359,582 S * 6/1995 Schremmer D28/54.1
D415,857 S * 10/1999 Ayre D28/54.1
D432,266 S * 10/2000 Lefebvre D28/54.1
D441,139 S * 4/2001 Hansen D28/54.1
D532,552 S * 11/2006 Hsu D28/54.1

D533,306 S * 12/2006 Hsu D28/54.1
D580,596 S * 11/2008 Hsu D28/54.1
D599,059 S * 8/2009 Clerch D28/54.1
D614,812 S * 4/2010 Liu D28/54.1
D622,908 S * 8/2010 Sau Clerch D28/54.1
D652,988 S * 1/2012 Schumann D28/19
D672,091 S * 12/2012 Dyson D28/54.1
D676,604 S * 2/2013 Liu D28/54.1
D742,591 S * 11/2015 Takiguchi D28/54.1
2008/0256825 A1 * 10/2008 Hsu A47K 10/48
34/529
2014/0141710 A1 * 5/2014 Turrini-Rochford . F26B 21/004
454/284
2014/0212304 A1 * 7/2014 Michael F04D 25/082
417/363
2015/0320268 A1 * 11/2015 Steele A47K 10/48
34/241

* cited by examiner

Primary Examiner — T. Chase Nelson
Assistant Examiner — Michelle E Wilson
(74) *Attorney, Agent, or Firm* — Banner & Witcoff, Ltd.

(57) **CLAIM**
The ornamental design for a hand dryer, as shown and described.

DESCRIPTION

FIG. 1 is a perspective view of a hand dryer showing our new design;
FIG. 2 is a front view thereof;
FIG. 3 is a rear view thereof;
FIG. 4 is a left side view thereof;
FIG. 5 is a right side view thereof;
FIG. 6 is a top view thereof; and,
FIG. 7 is a bottom view thereof.
The broken lines shown are included for the purpose of illustrating the unclaimed portions of the hand dryer and form no part of the claimed design.

1 Claim, 6 Drawing Sheets

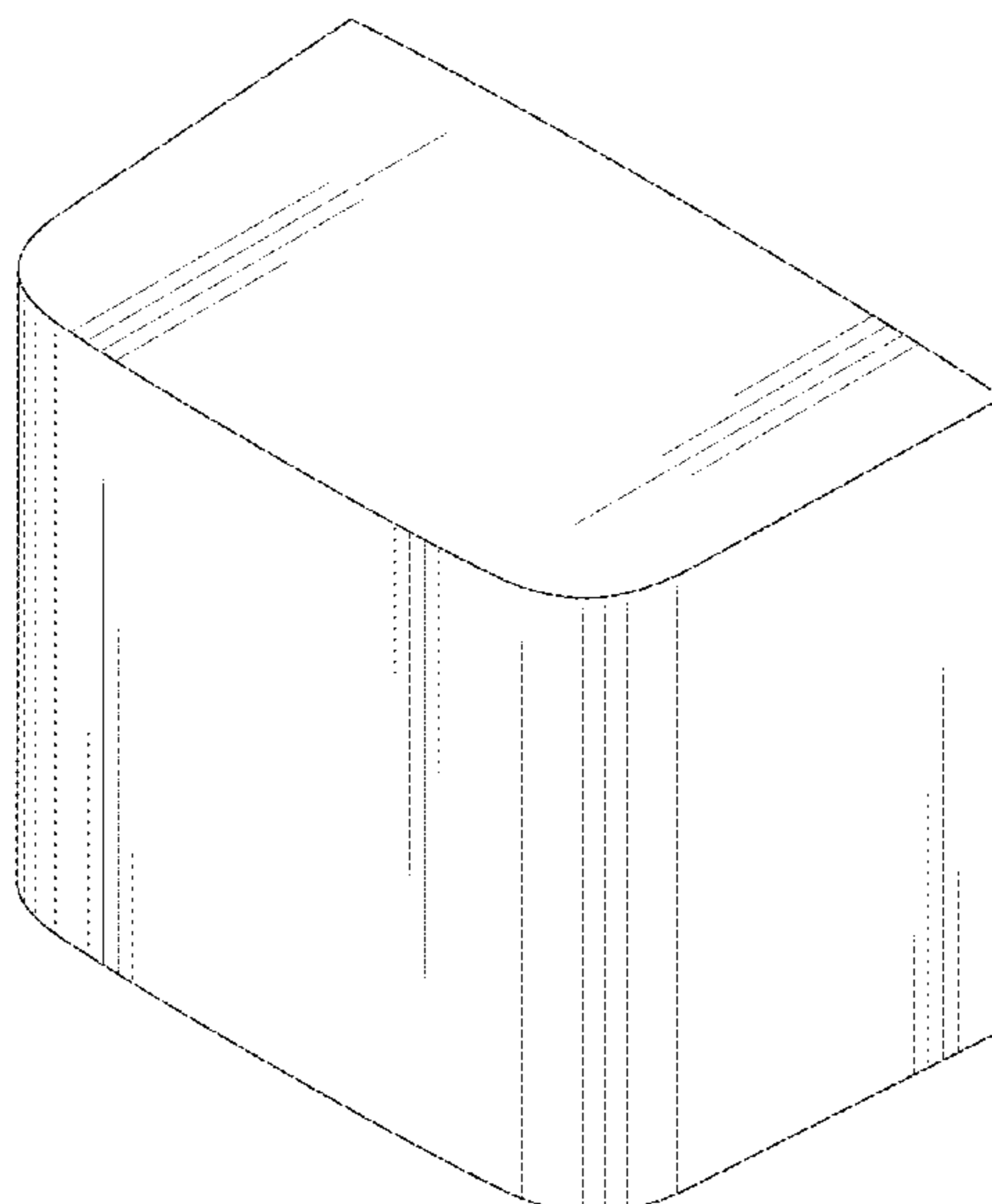

Fig. 1

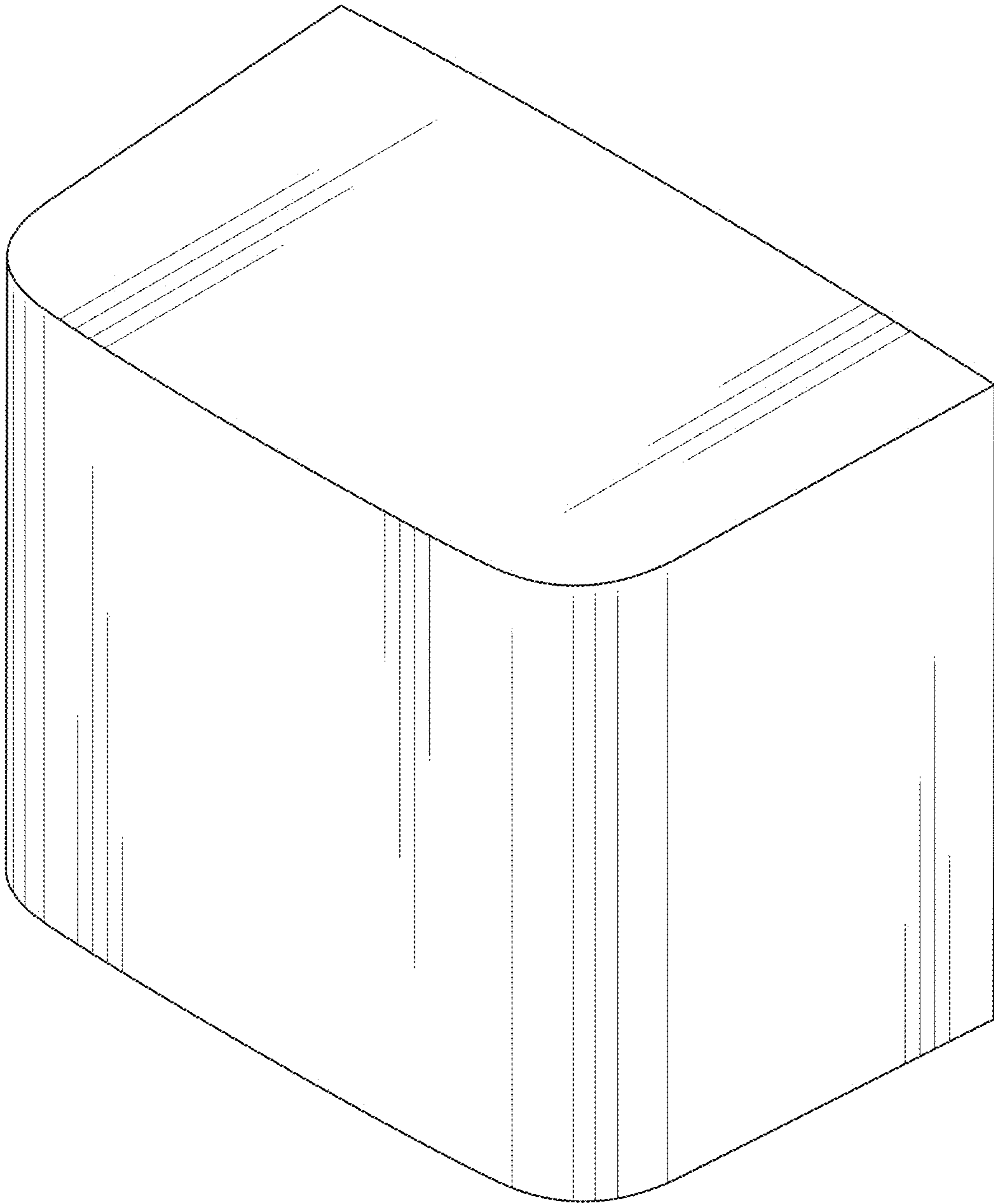

Fig. 2

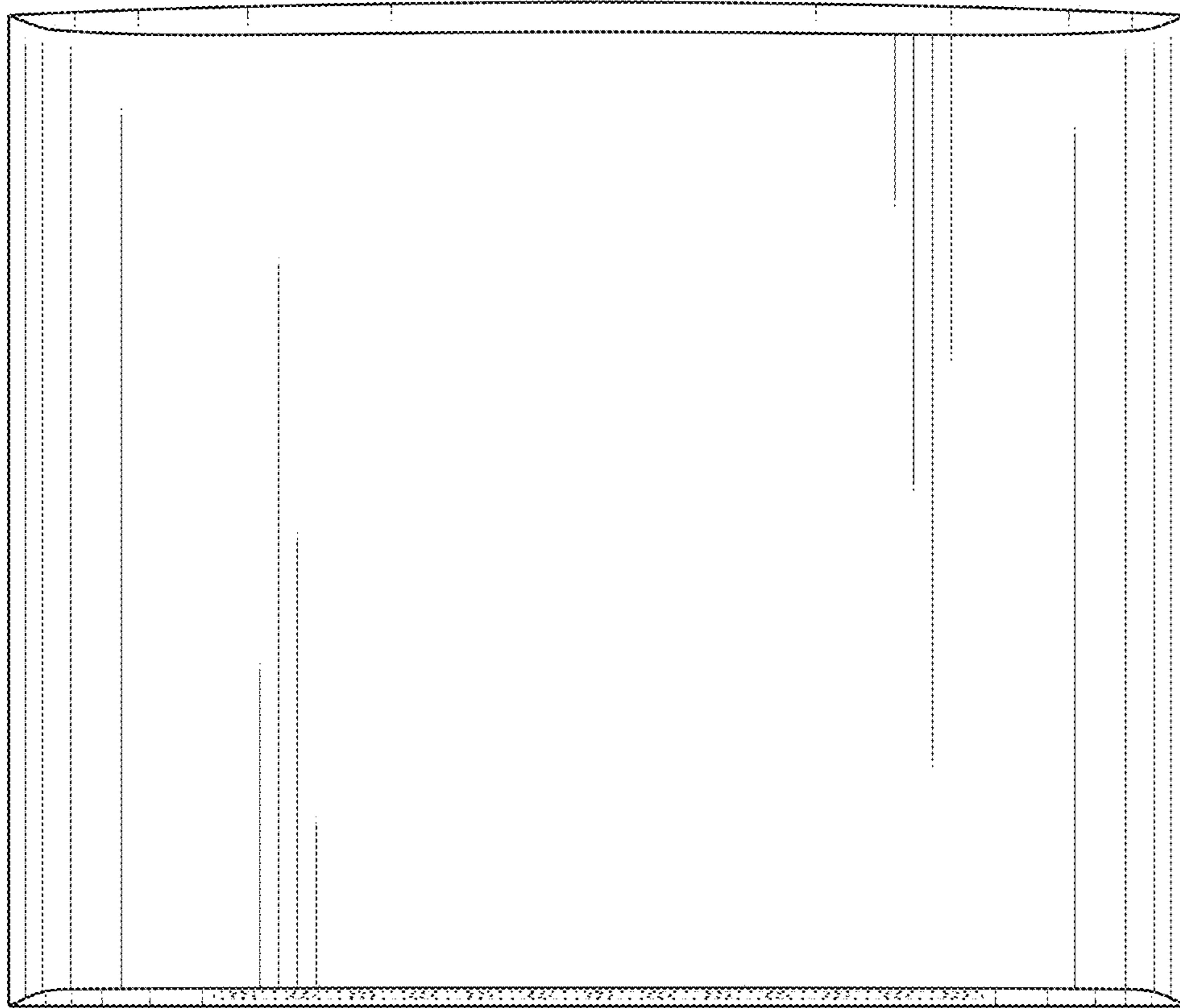

Fig. 3

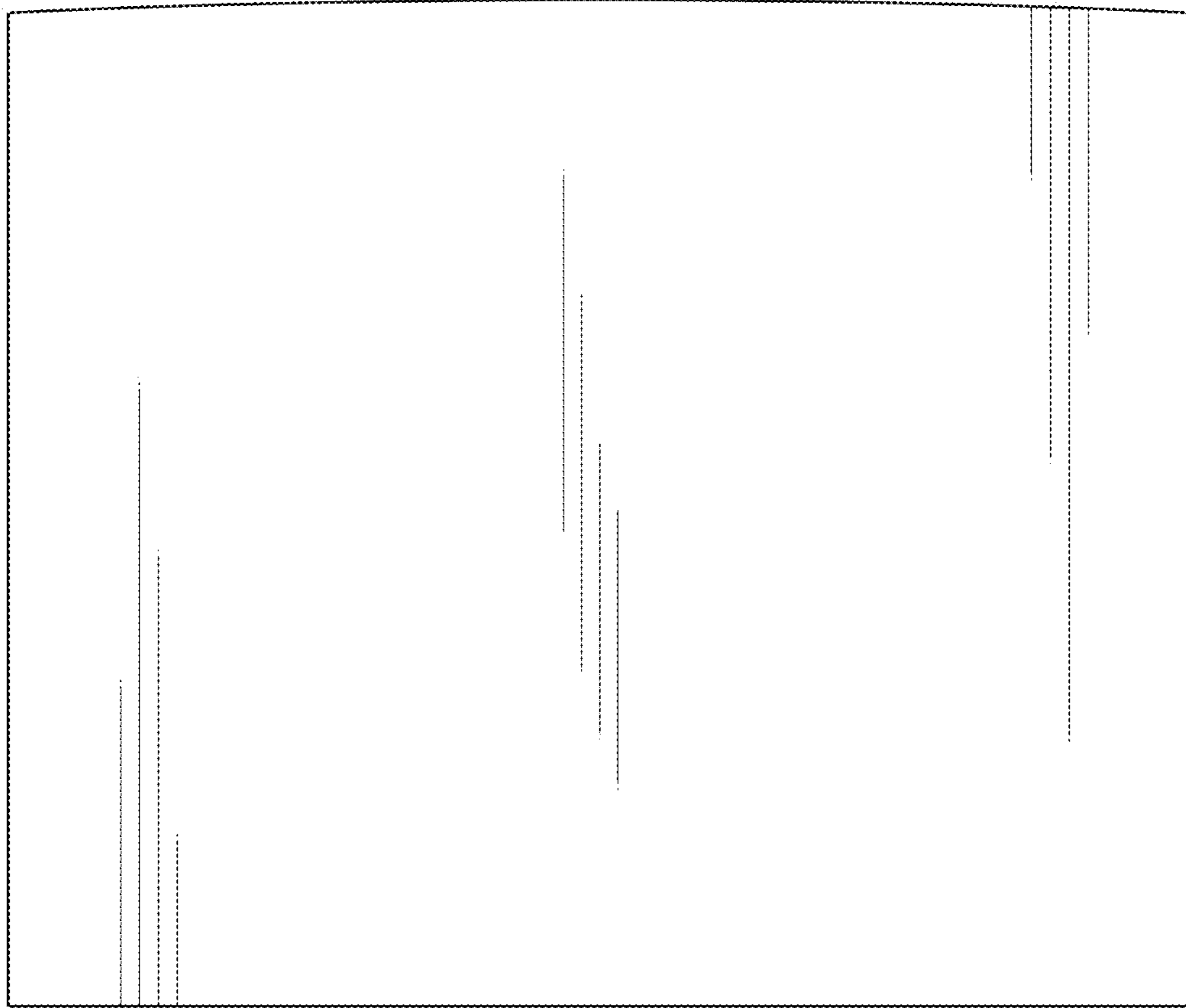

Fig. 4

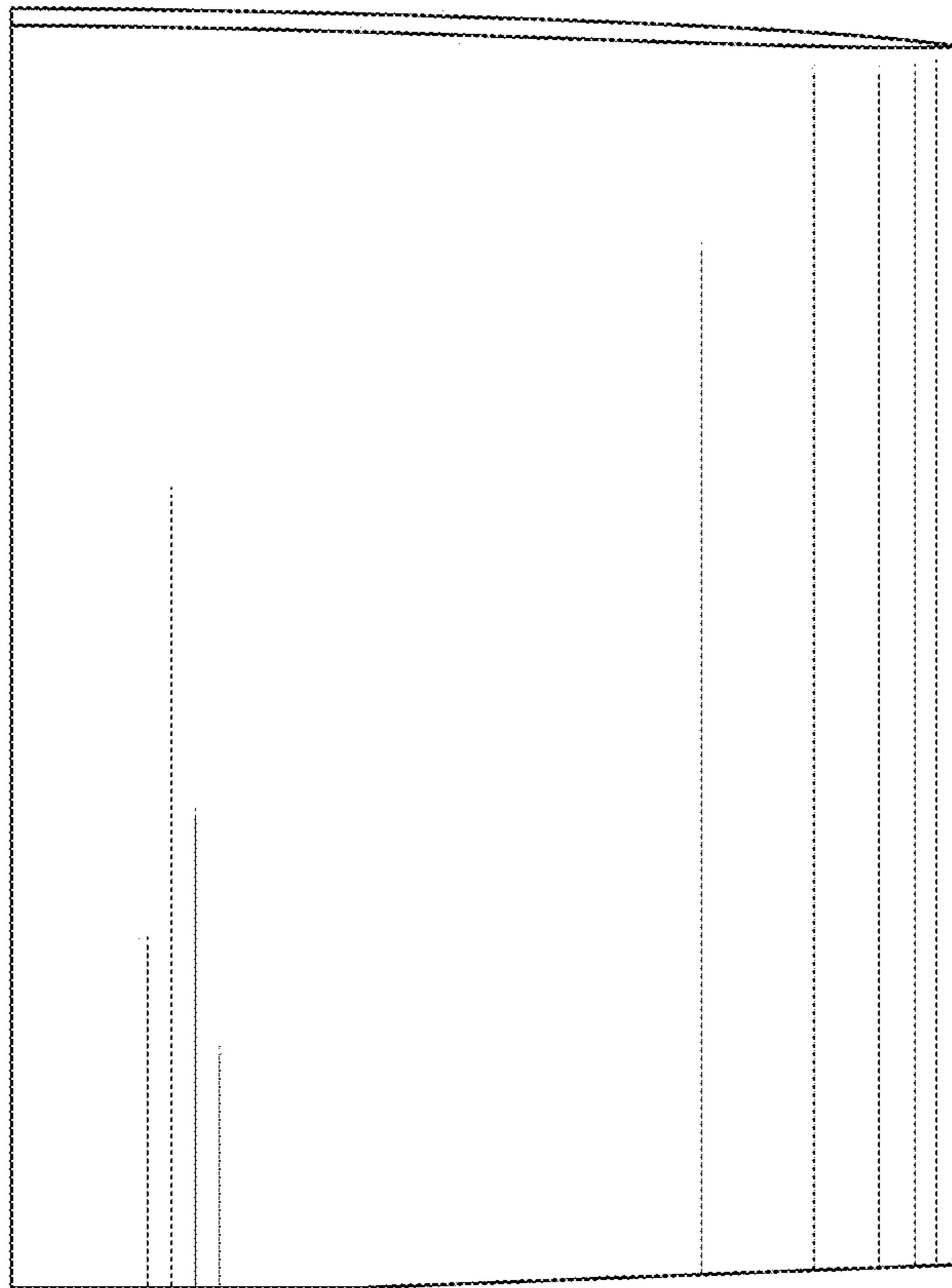

Fig. 5

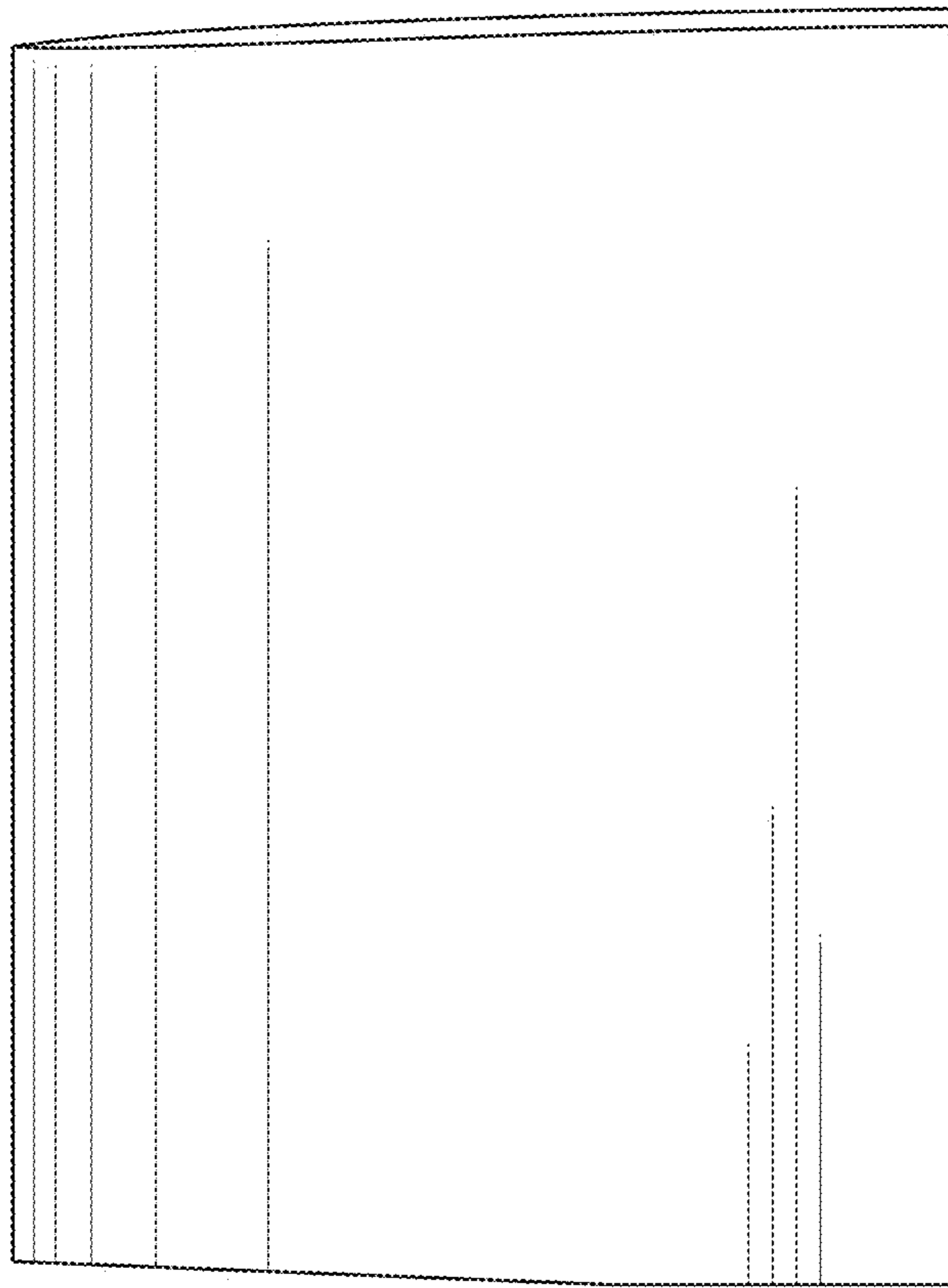

Fig. 6

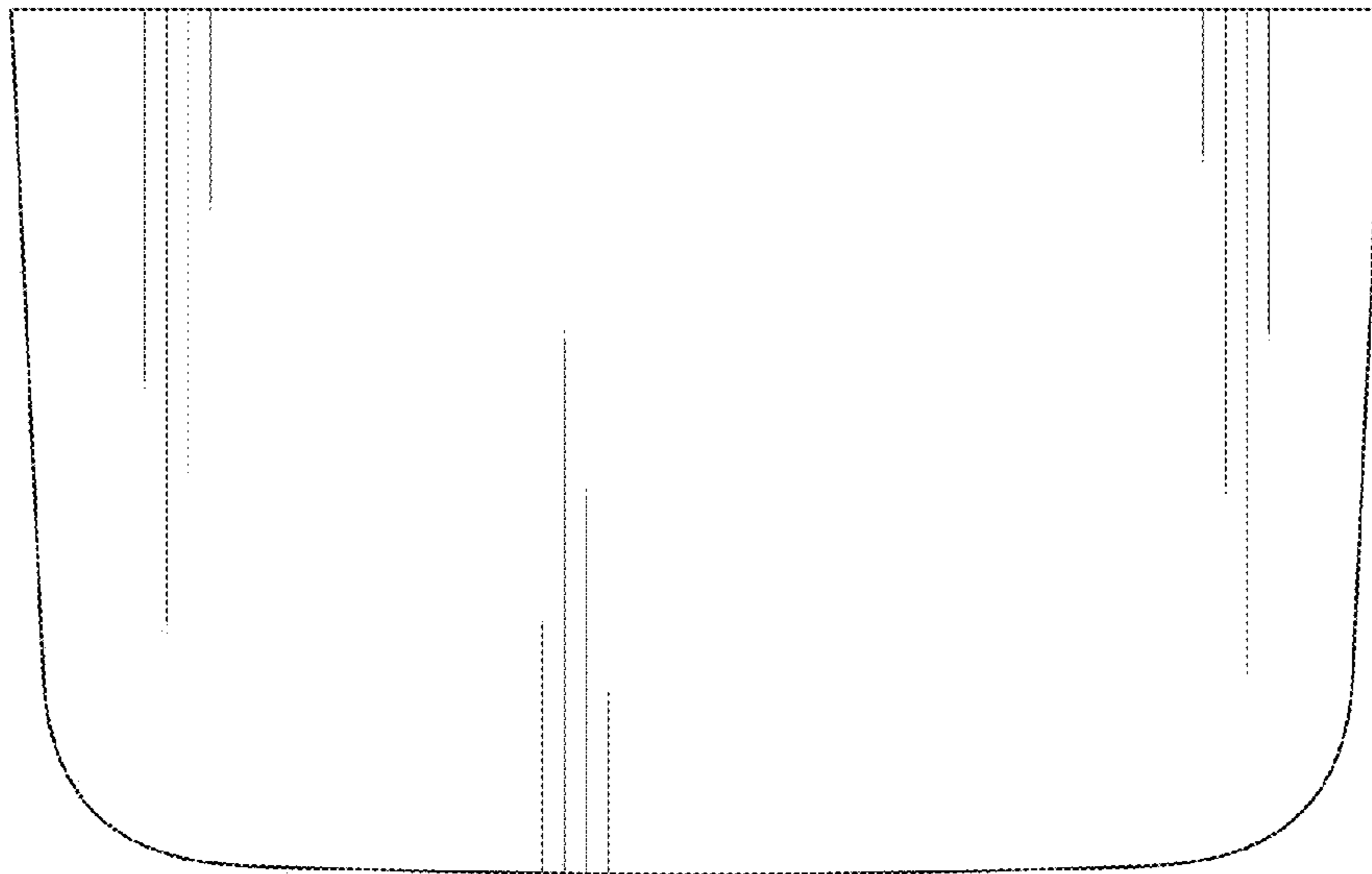

Fig. 7

