



US00D757905S

(12) **United States Design Patent**
Rexach

(10) **Patent No.:** **US D757,905 S**
(45) **Date of Patent:** **** May 31, 2016**

- (54) **FAUCET**
- (71) Applicant: **Kohler Co.**, Kohler, WI (US)
- (72) Inventor: **Rafael A. Rexach**, Sheboygan, WI (US)
- (73) Assignee: **KOHLER CO.**, Kohler, WI (US)
- (**) Term: **15 Years**
- (21) Appl. No.: **29/543,034**
- (22) Filed: **Oct. 20, 2015**

- D478,153 S 8/2003 Friedrich
- D482,757 S 11/2003 Blomstrom
- D482,758 S 11/2003 Bates et al.
- D483,093 S 12/2003 Bates et al.
- D487,916 S 3/2004 Lord
- D500,549 S 1/2005 Blomstrom
- D508,108 S 8/2005 Blomstrom
- D516,177 S 2/2006 Ouyoung
- D516,681 S 3/2006 Gilbert
- D530,795 S 10/2006 Sutopo
- D531,273 S 10/2006 Tsai
- D534,621 S 1/2007 Chu et al.
- D534,987 S 1/2007 Eilmus
- D562,947 S 2/2008 Zhang
- D579,080 S 10/2008 Zhang
- D582,011 S 12/2008 Yuan
- D591,402 S 4/2009 Eckhaus
- 7,533,683 B2 5/2009 Ortega et al.
- D636,850 S 4/2011 Shieh

Related U.S. Application Data

- (62) Division of application No. 29/509,192, filed on Nov. 14, 2014.
- (51) **LOC (10) Cl.** **23-01**
- (52) **U.S. Cl.**
USPC **D23/238**
- (58) **Field of Classification Search**
USPC D23/238-243, 249, 253, 255, 257, 250,
D23/252
CPC E03C 1/04; E03C 1/0401; E03C 1/0402;
E03C 1/0404
See application file for complete search history.

(Continued)

Primary Examiner — Robert Delehanty
(74) *Attorney, Agent, or Firm* — Foley & Lardner LLP

(57) **CLAIM**
I claim the ornamental design for a faucet, as shown and described.

DESCRIPTION

FIG. 1 is a top, front, left perspective view of an embodiment of the claimed design;
FIG. 2 is a right elevation view thereof;
FIG. 3 is a left elevation view thereof;
FIG. 4 is a front elevation view thereof;
FIG. 5 is a rear elevation view thereof;
FIG. 6 is a top plan view thereof; and,
FIG. 7 is a bottom plan view thereof.
The ornamental design which is claimed is shown in solid lines in the drawings. The broken lines in the drawings form no part of the claimed design. Broken lines formed by equal length dashes show unclaimed subject matter.

1 Claim, 6 Drawing Sheets

- (56) **References Cited**
U.S. PATENT DOCUMENTS
- 1,838,290 A 12/1931 Steckel
- D318,905 S 8/1991 Reid
- D348,509 S 7/1994 Bollenbacher
- D349,208 S 8/1994 Bollenbacher
- D349,328 S 8/1994 Bollenbacher
- D349,331 S 8/1994 Bollenbacher
- D349,948 S 8/1994 Bollenbacher et al.
- D350,184 S 8/1994 Kohler, Jr.
- D350,390 S 9/1994 Bollenbacher
- D352,095 S 11/1994 Bollenbacher
- D354,548 S 1/1995 Bollenbacher et al.
- D471,964 S 3/2003 Bates et al.

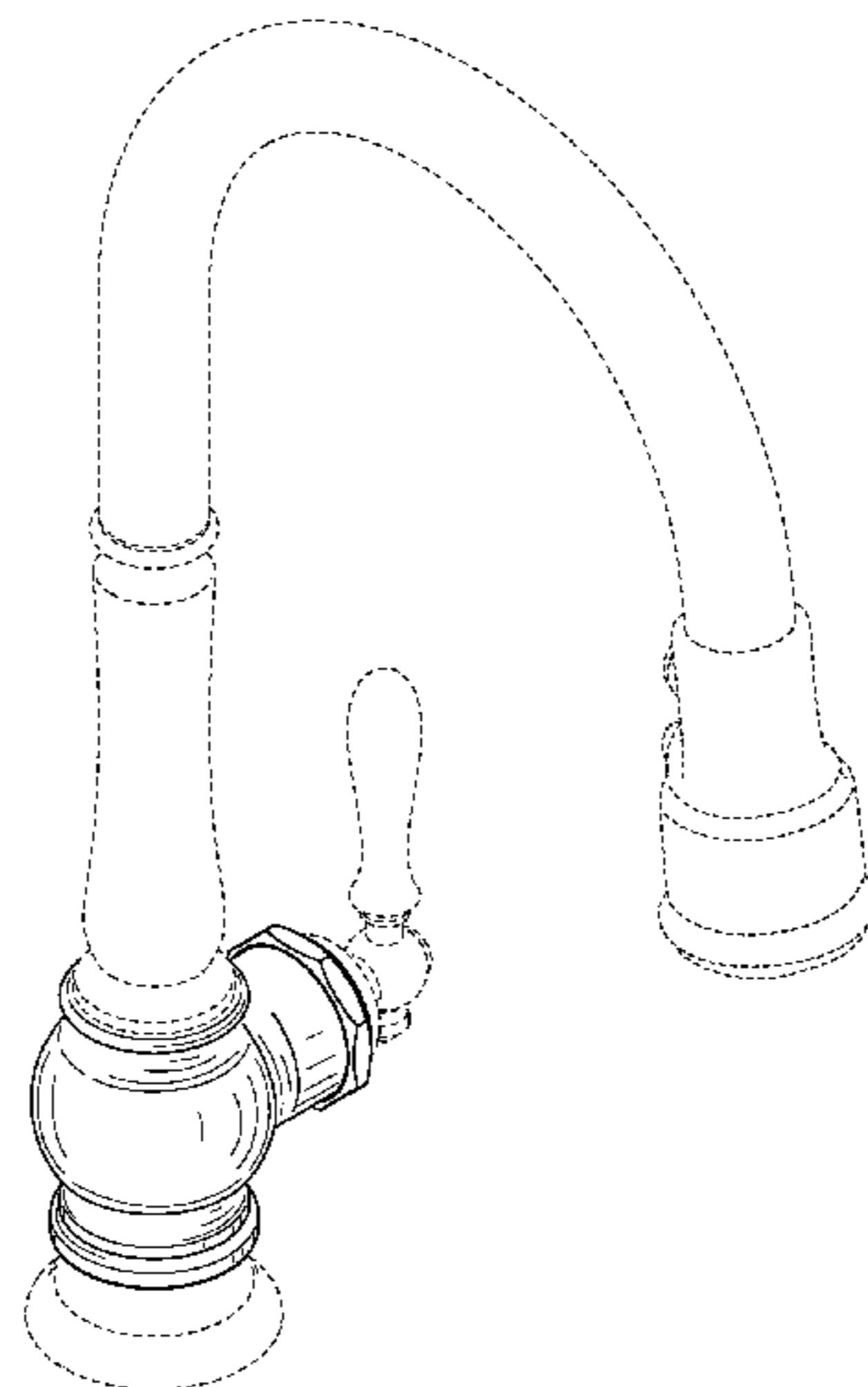

(56)

References Cited

U.S. PATENT DOCUMENTS

D641,454 S 7/2011 Mckeone
D645,944 S 9/2011 Gilbert
D651,454 S 1/2012 Chin

D713,508 S 9/2014 Downey et al.
D713,510 S 9/2014 Downey et al.
D717,928 S 11/2014 Rexach et al.
D718,420 S 11/2014 Rexach et al.
D718,425 S 11/2014 Rexach et al.
D718,426 S 11/2014 Rexach et al.
9,151,405 B2 10/2015 Marotz et al.

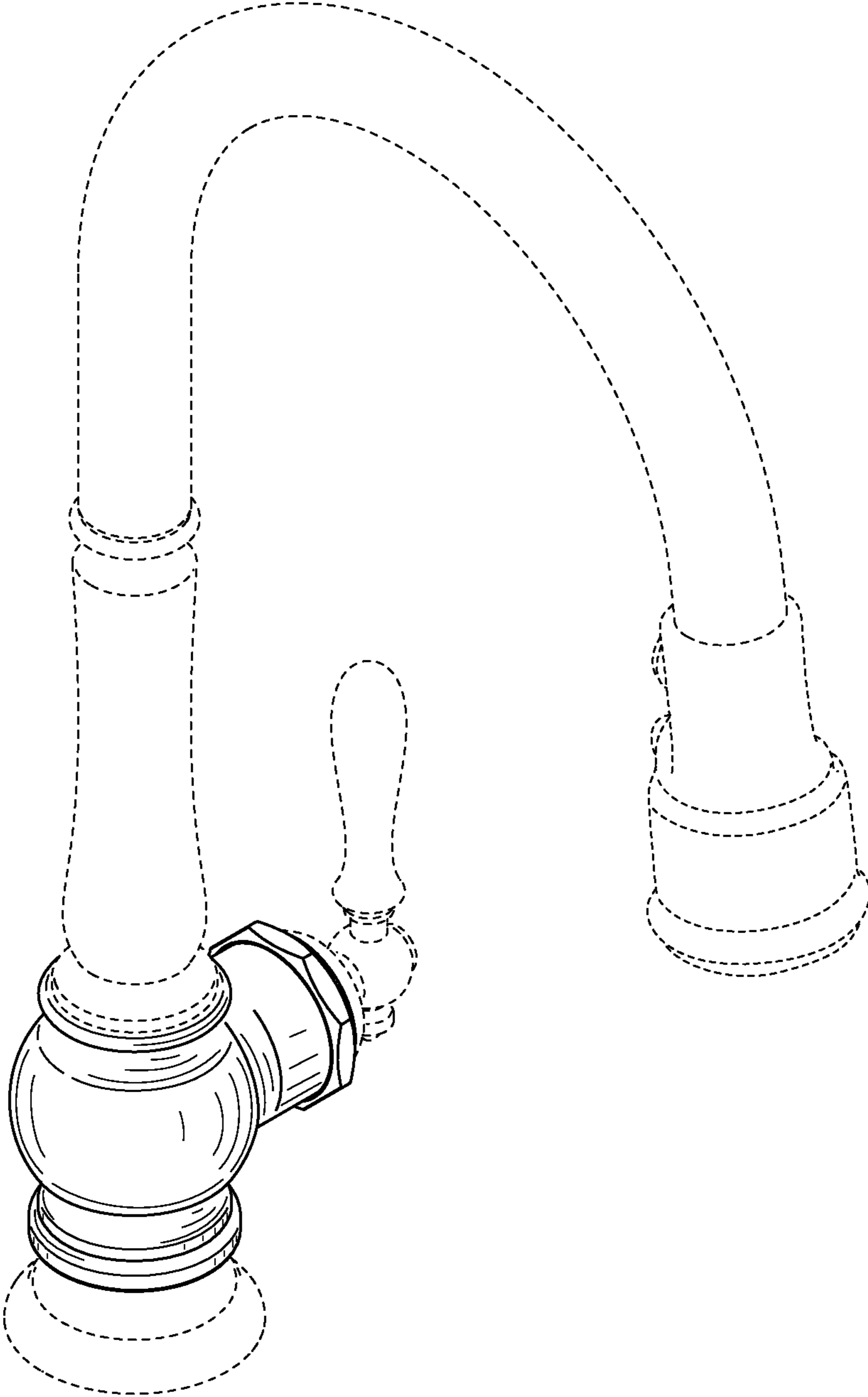

FIG. 1

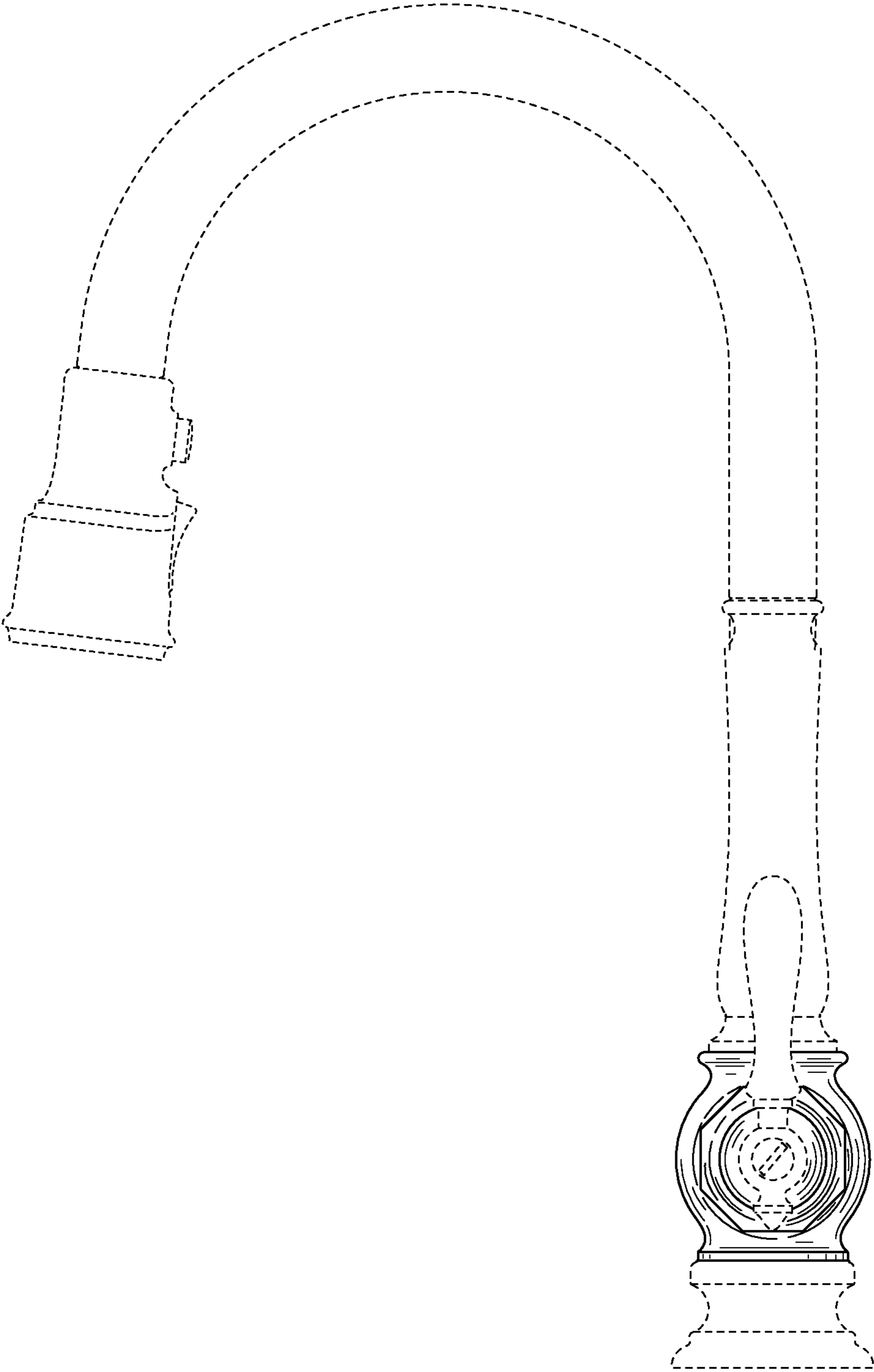

FIG. 2

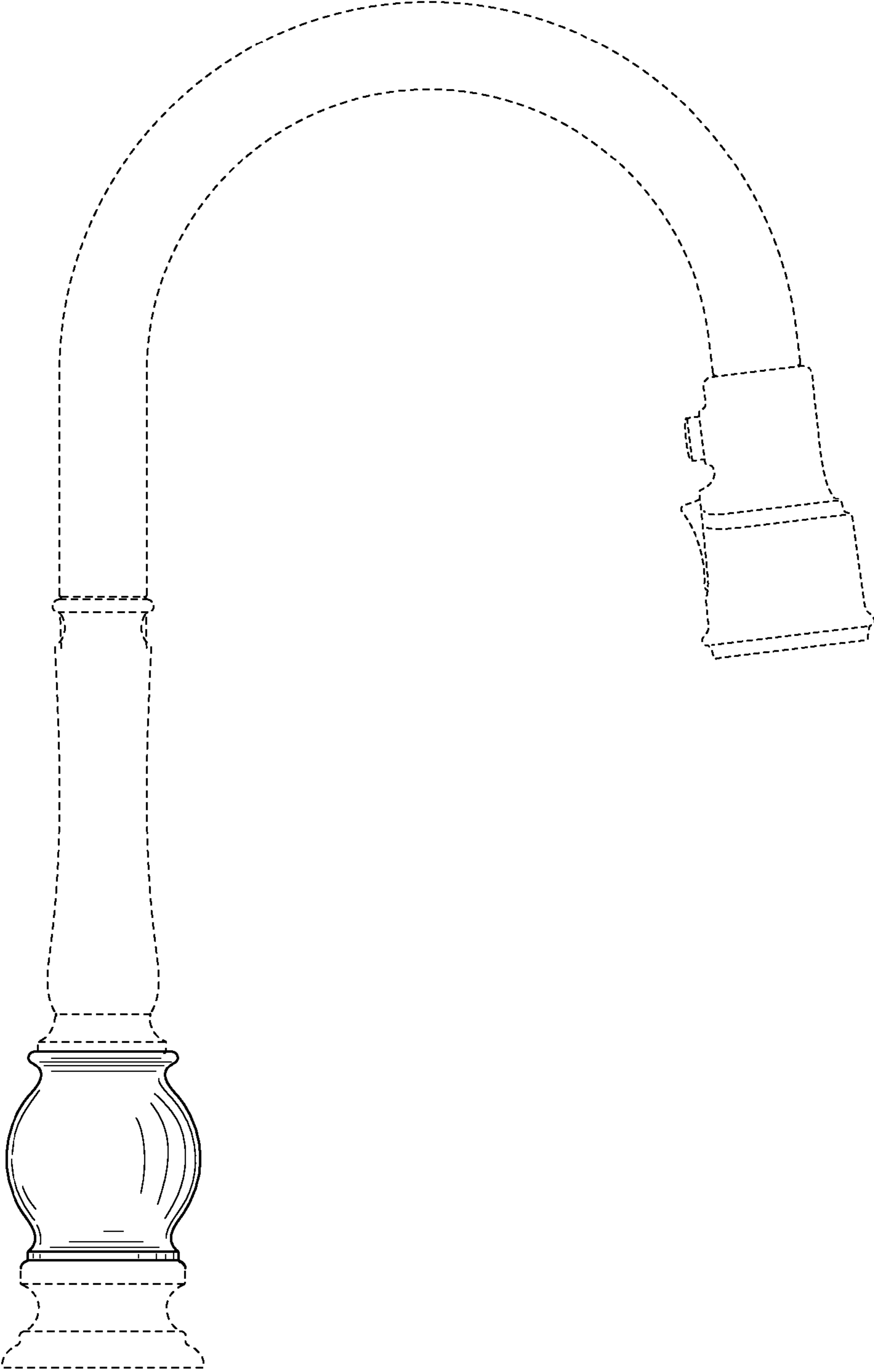

FIG. 3

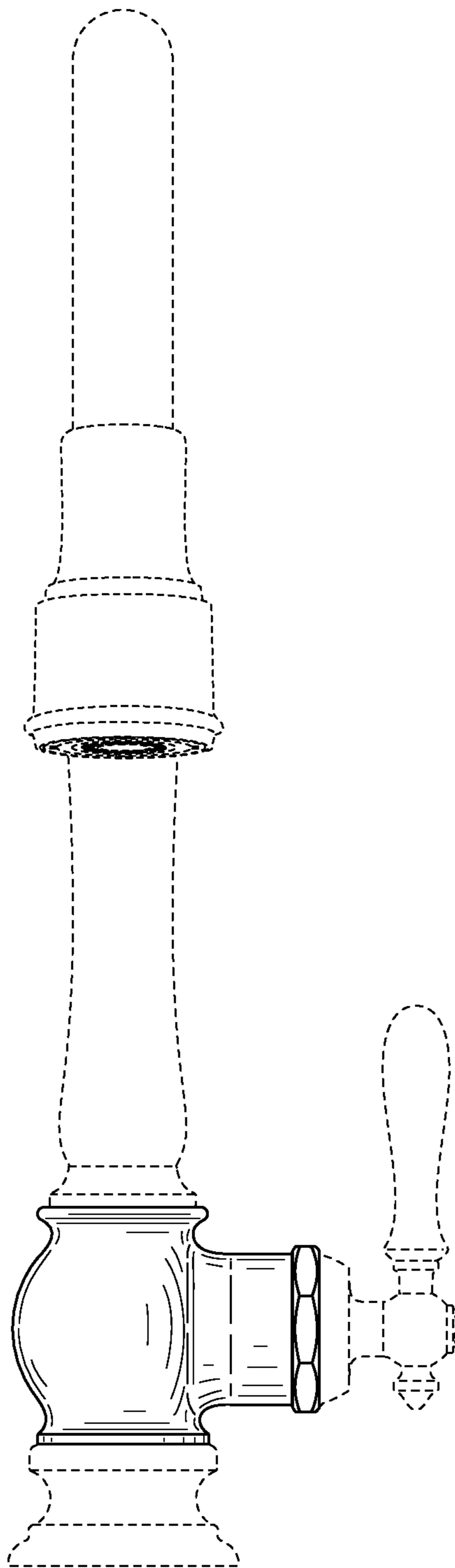

FIG. 4

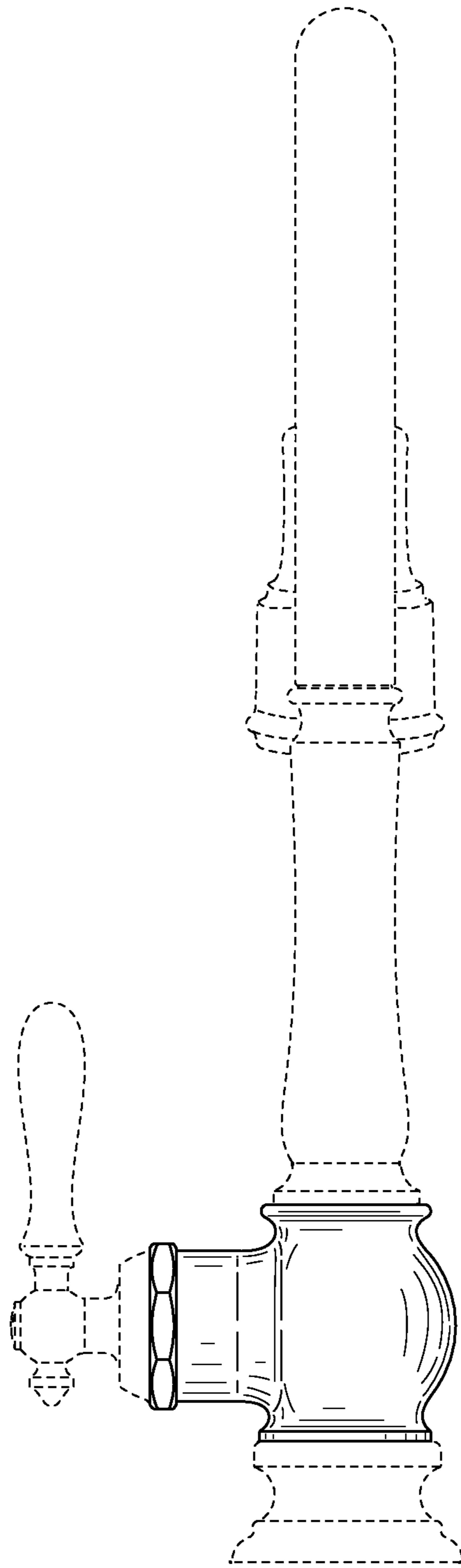

FIG. 5

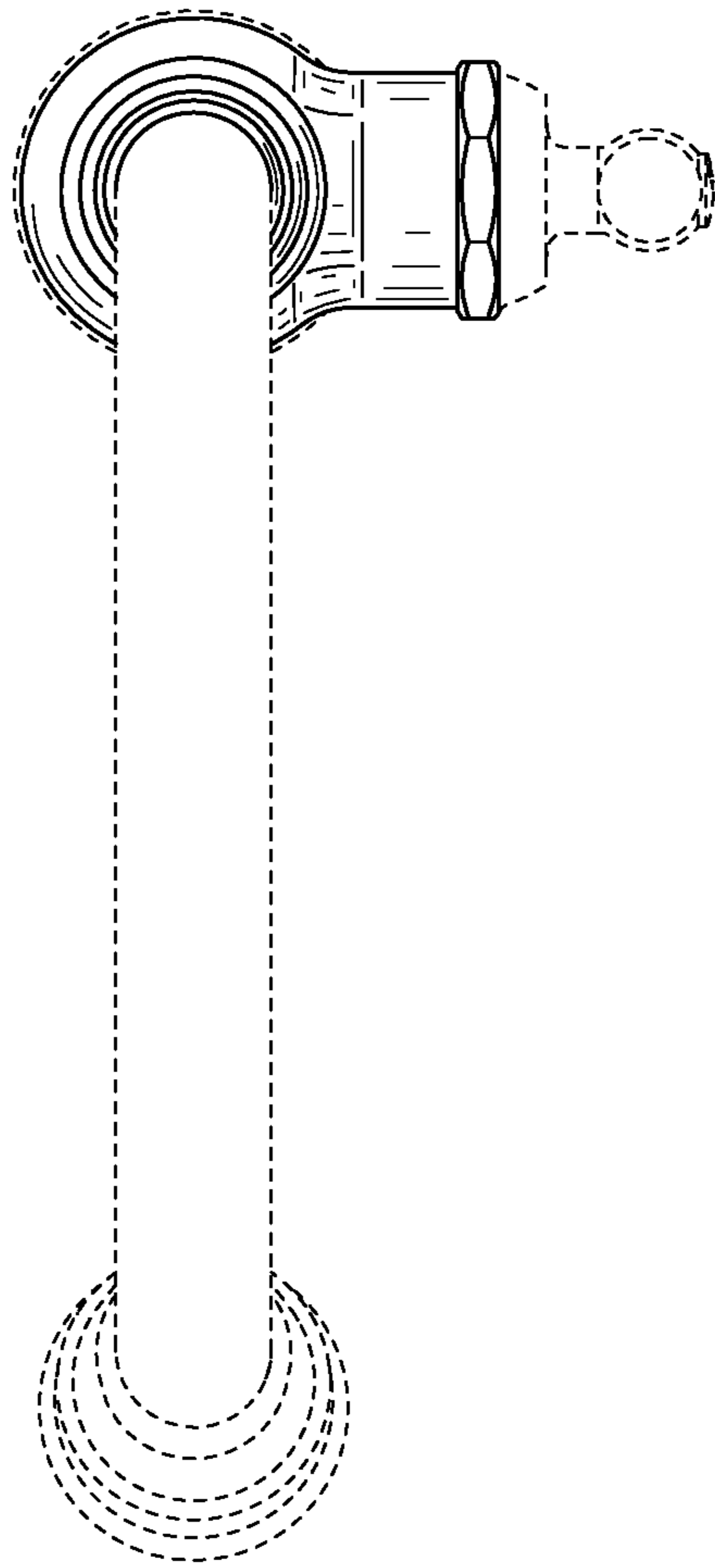

FIG. 6

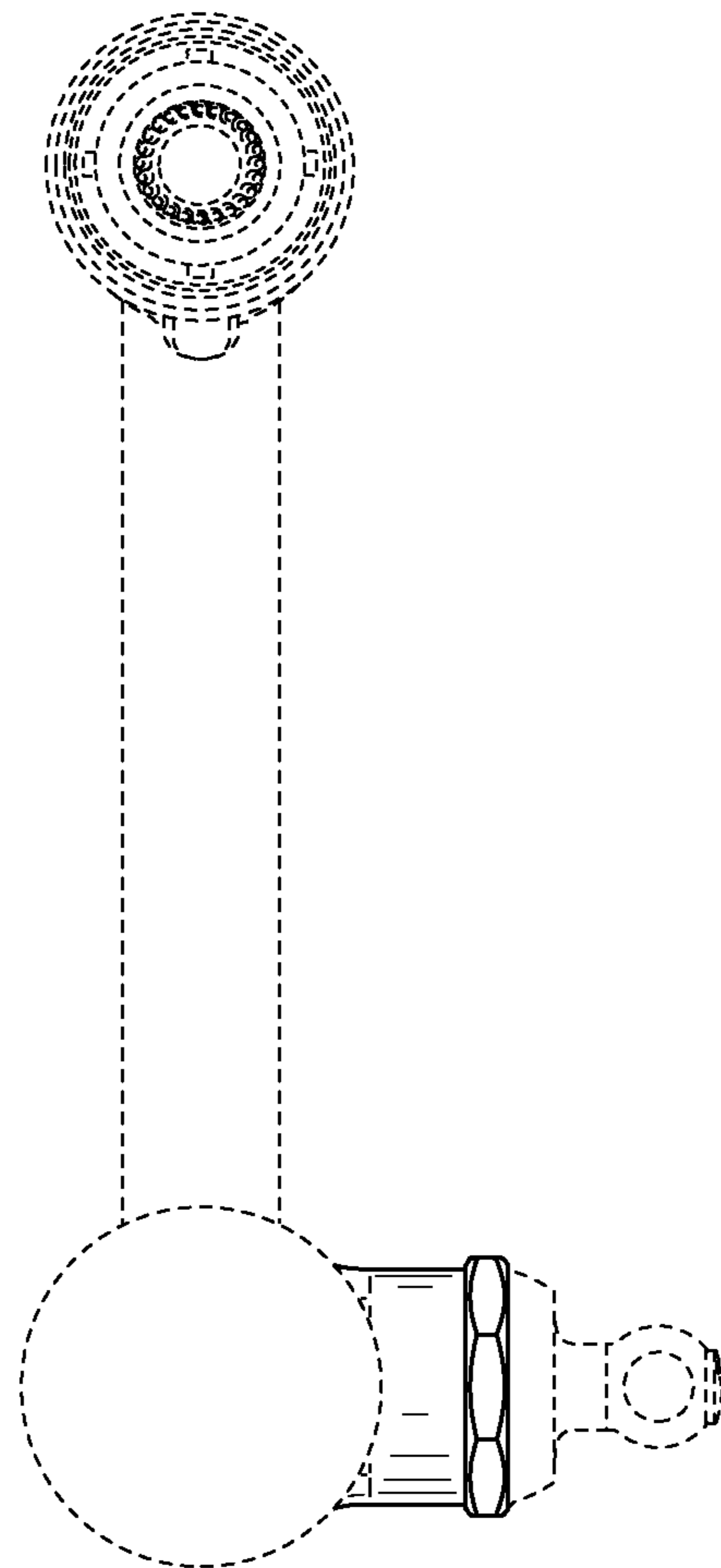

FIG. 7