



US00D757852S

(12) **United States Design Patent**
Bonacina et al.

(10) **Patent No.:** **US D757,852 S**

(45) **Date of Patent:** **** *May 31, 2016**

(54) **CLIP**

(71) Applicant: **Poppin Inc.**, New York, NY (US)

(72) Inventors: **Matteo Bonacina**, Astoria, NY (US);
Won Sik Keum, New York, NY (US);
Jeffrey Frederick Miller, New York,
NY (US); **Michael Shuman**, New York,
NY (US)

(73) Assignee: **Poppin, Inc.**, New York, NY (US)

(*) Notice: This patent is subject to a terminal disclaimer.

(**) Term: **14 Years**

(21) Appl. No.: **29/466,103**

(22) Filed: **Sep. 4, 2013**

(51) **LOC (10) Cl.** **19-06**

(52) **U.S. Cl.**
USPC **D19/197**

(58) **Field of Classification Search**
USPC D14/411; D19/115-186, 190-204;
24/11 F, 11 P, 11 R; 401/52, 99, 192,
401/195, 196
CPC B43K 23/08; B43K 23/10; B43K 23/12;
B43K 23/124; B43K 23/126; B43K 25/02;
B43K 25/022; B43K 25/024; B43K 25/026;
B43K 25/028

See application file for complete search history.

(56) **References Cited**

U.S. PATENT DOCUMENTS

D266,769 S * 11/1982 Camps D19/51
D327,911 S * 7/1992 Poisson D19/49
D334,408 S * 3/1993 Takemura D19/56
D345,578 S * 3/1994 Zier D19/48

D403,706 S * 1/1999 Fukami D19/51
D448,407 S * 9/2001 Huang D19/43
D455,180 S * 4/2002 Hasegawa D19/57
D467,970 S * 12/2002 Pellissa Beneyto D19/43
D539,847 S * 4/2007 Roeloffs D19/123
D545,366 S * 6/2007 Ternovits D19/51
D568,932 S * 5/2008 Qiu et al. D19/43
D570,415 S * 6/2008 Richter et al. D19/56
D601,627 S * 10/2009 Liu D19/51
D605,695 S * 12/2009 Leibeck D19/43
D607,934 S * 1/2010 Liu D19/49
D616,935 S * 6/2010 Zhang D19/48
D642,621 S * 8/2011 Keum et al. D19/56
D662,986 S * 7/2012 Liu D19/51
D668,293 S * 10/2012 Chen D19/49
D670,289 S * 11/2012 Bae et al. D14/411
D693,877 S * 11/2013 Lv D19/163
D694,324 S * 11/2013 Cambianica D19/186
D694,325 S * 11/2013 Cambianica D19/186
D717,301 S * 11/2014 Groene D14/411
D728,688 S * 5/2015 Hung D19/166
D736,317 S * 8/2015 Miller D19/173
2009/0265859 A1 * 10/2009 Bhavnani B43K 25/026
7/160

* cited by examiner

Primary Examiner — Elizabeth Albert

(74) *Attorney, Agent, or Firm* — K&L Gates LLP

(57) **CLAIM**

The ornamental design for a clip, as shown and described.

DESCRIPTION

FIG. 1 is a perspective view of a clip;
FIG. 2 is a front elevation view thereof;
FIG. 3 is a rear elevation view thereof;
FIG. 4 is a right side elevation view thereof;
FIG. 5 is a left side elevation view thereof;
FIG. 6 is a top plan view thereof; and,
FIG. 7 is a bottom plan view thereof.

1 Claim, 4 Drawing Sheets

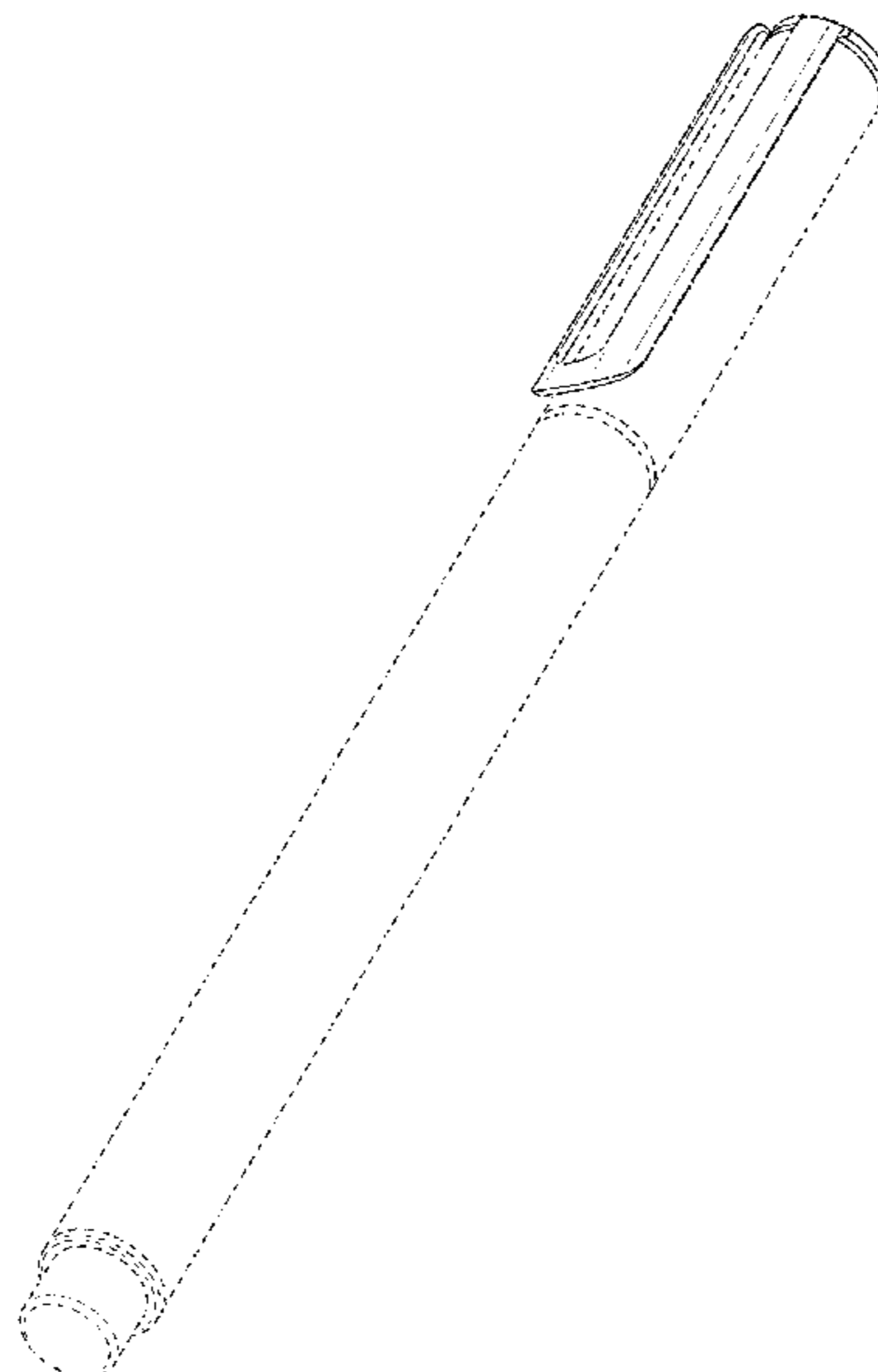

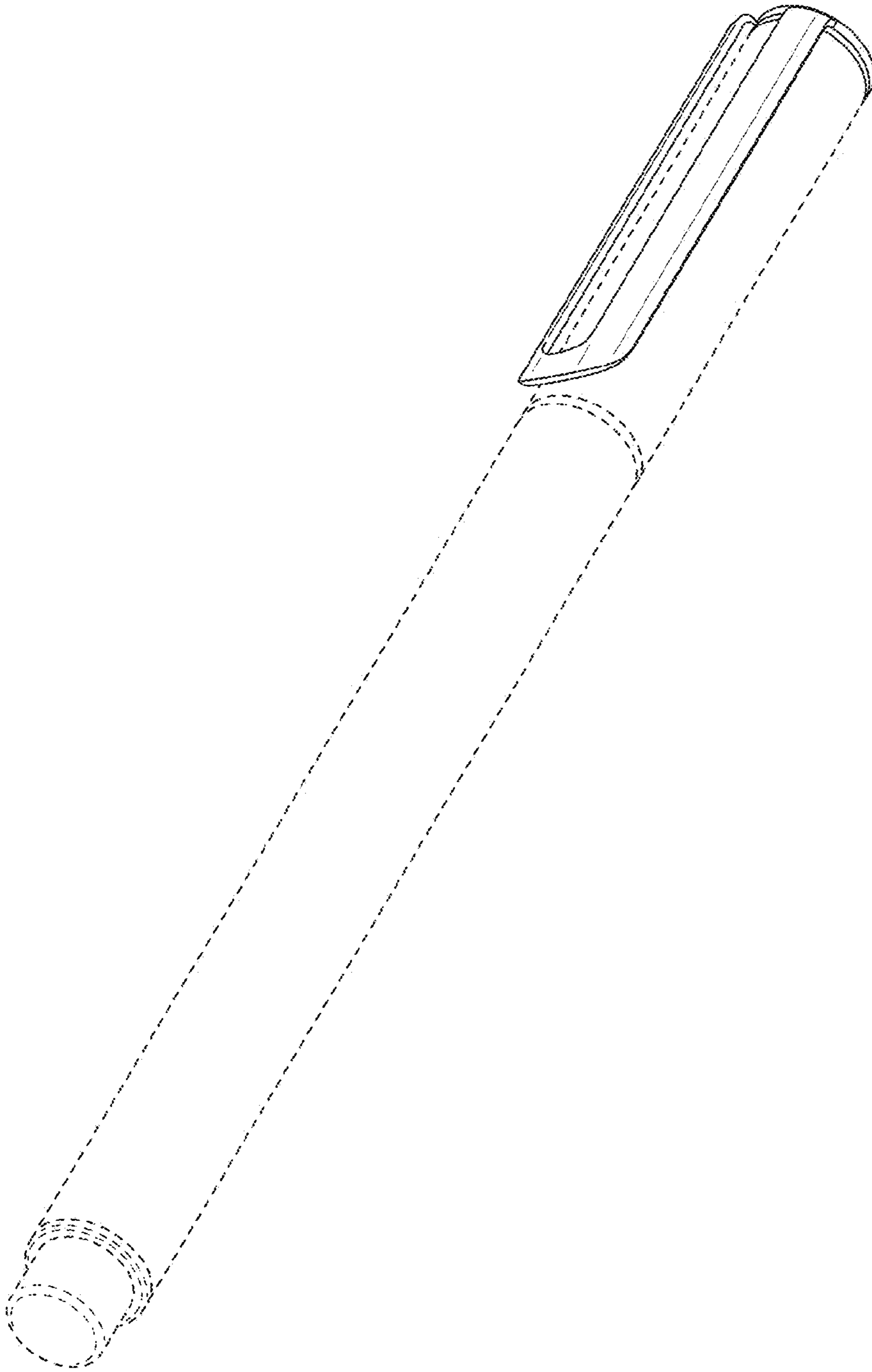

FIG. 1

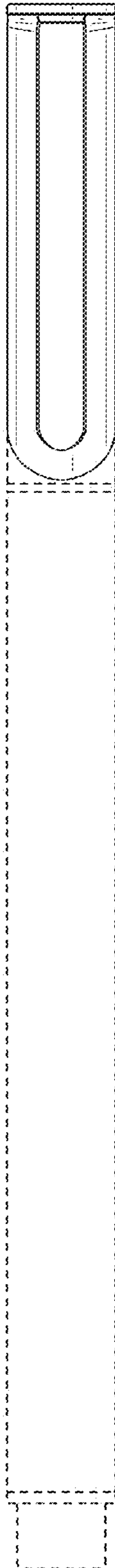

FIG. 2

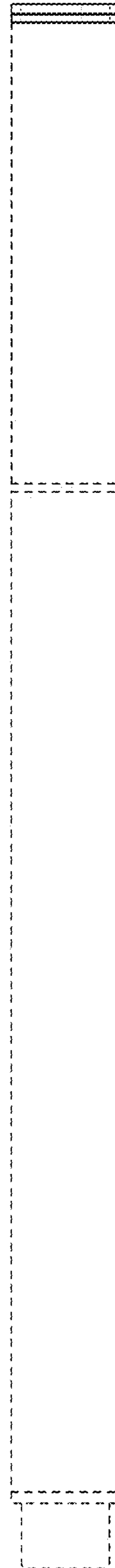

FIG. 3



FIG. 4

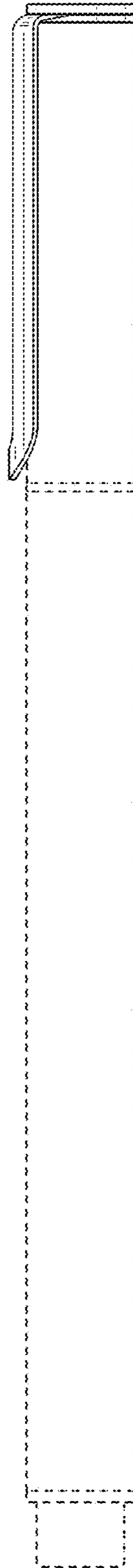

FIG. 5

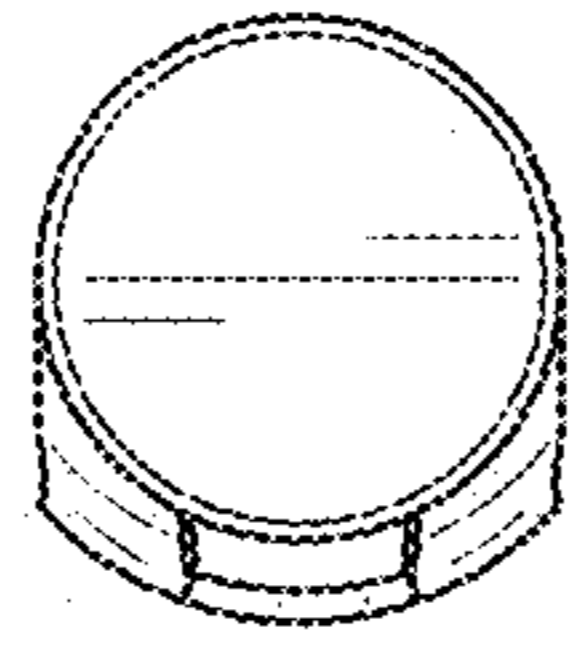

FIG. 6

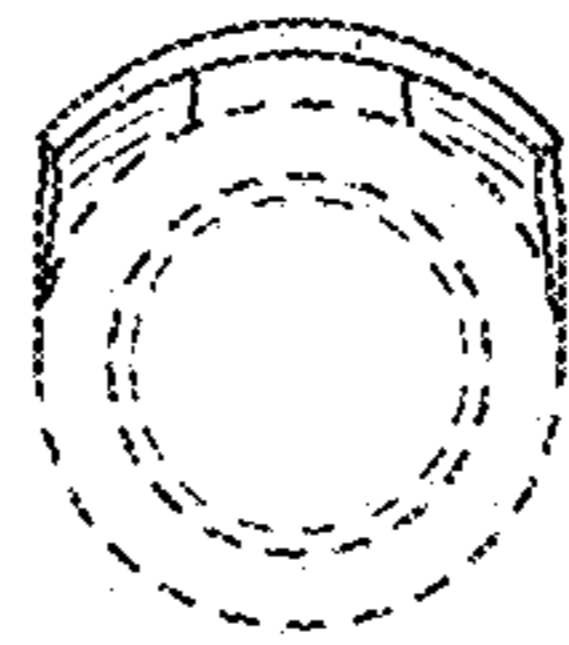

FIG. 7