

US00D757851S

(12) **United States Design Patent**
Nichols et al.

(10) **Patent No.:** **US D757,851 S**
(45) **Date of Patent:** **** May 31, 2016**

- (54) **MARKER**
- (71) Applicant: **Lanard Toys Limited**, Kowloon (HK)
- (72) Inventors: **Blake Christopher Nichols**, Tarzana, CA (US); **Logan James Williams**, Thousand Oaks, CA (US)
- (73) Assignee: **Lanard Toys Limited**, Hong Kong (CN)
- (**) Term: **14 Years**
- (21) Appl. No.: **29/509,601**
- (22) Filed: **Nov. 19, 2014**
- (51) **LOC (10) Cl.** **19-06**
- (52) **U.S. Cl.**
USPC **D19/163; D19/902**
- (58) **Field of Classification Search**
USPC **D14/411; D19/115-204**
CPC **B43K 5/00; B43K 5/005; B43K 7/00;**
B43K 7/10; B43K 7/12; B43K 8/04
See application file for complete search history.

D497,640 S *	10/2004	Qiu	D19/167
D508,948 S *	8/2005	Metaxatos	D19/164
7,004,660 B2 *	2/2006	Kaempf	B43K 23/08 401/198
D541,340 S *	4/2007	Qiu	D19/163
D559,311 S *	1/2008	Qiu	D19/166
D567,852 S *	4/2008	Qiu	D19/163
D597,133 S *	7/2009	Hung	D19/166
D601,193 S *	9/2009	Li	D19/163
D612,421 S *	3/2010	Suero, Jr.	D19/163
D676,621 S *	2/2013	Florkiewicz	D32/35
D725,704 S *	3/2015	Jiang	D19/163
D725,706 S *	3/2015	Jiang	D19/194
D742,966 S *	11/2015	Lir	D19/187

* cited by examiner

Primary Examiner — Elizabeth Albert

(74) *Attorney, Agent, or Firm* — Lerner, David, Littenberg, Krumholz & Mentlik, LLP

(57) **CLAIM**

The ornamental design for a marker, as shown and described.

DESCRIPTION

FIG. 1 is a perspective view of a marker with a cap showing our new design;
 FIG. 2 is a front elevation view thereof;
 FIG. 3 is a rear elevation view thereof;
 FIG. 4 is a left side elevation view thereof;
 FIG. 5 is a right side elevation view thereof;
 FIG. 6 is a top plan view thereof; and,
 FIG. 7 is a bottom plan view thereof.
 The broken lines represent the portions of the marker that form no part of the claimed design.

1 Claim, 4 Drawing Sheets

(56) **References Cited**

U.S. PATENT DOCUMENTS

3,039,132 A *	6/1962	Hambley	A45D 34/041 192/16
4,183,685 A *	1/1980	Hofmann	B43K 8/02 106/31.35
D325,931 S *	5/1992	Sekiguchi	D19/166
D399,253 S *	10/1998	Raymond	D19/117
D476,363 S *	6/2003	Hung	D19/166
D492,347 S *	6/2004	Qiu	D19/163

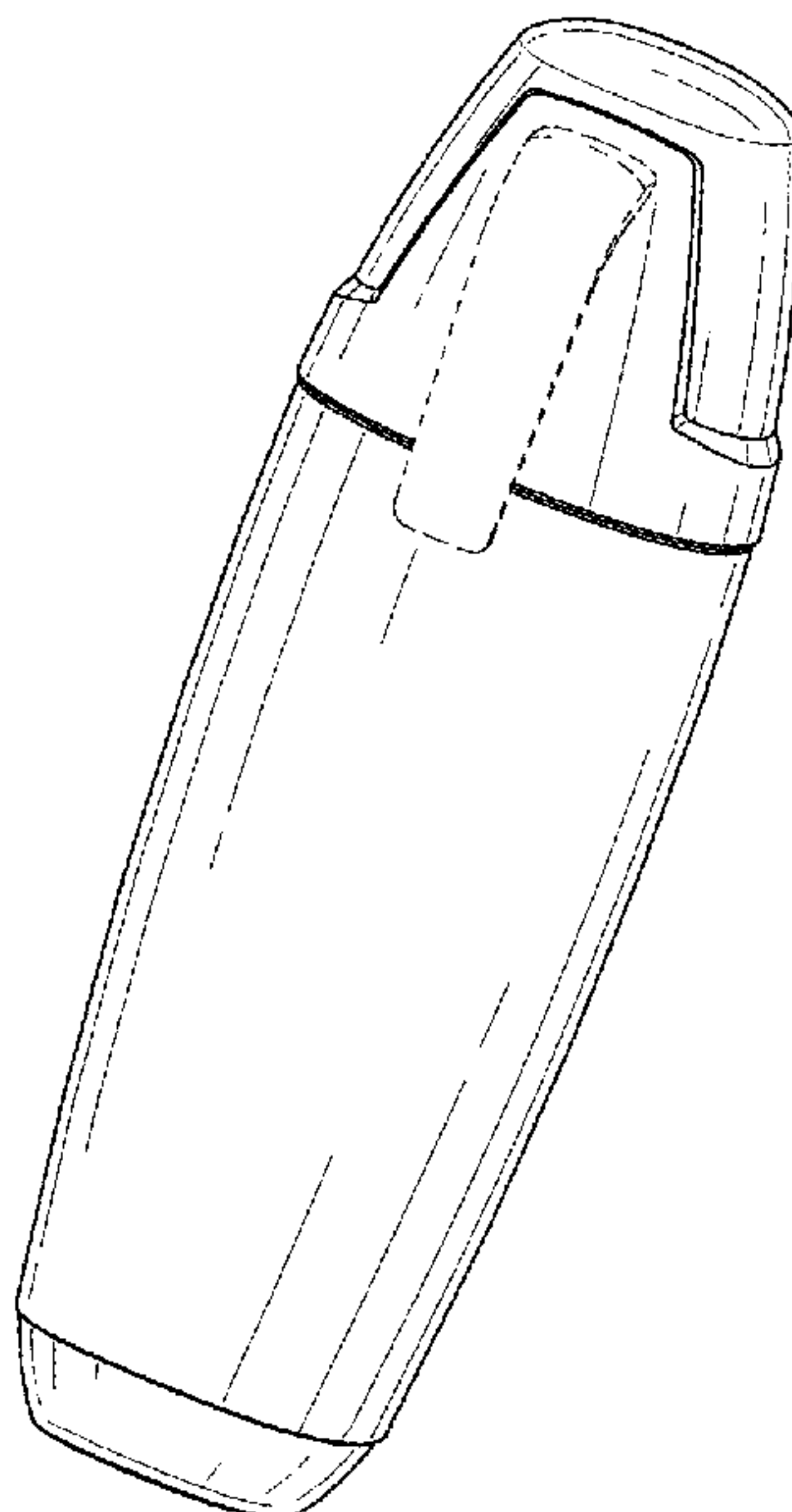

FIG. 1

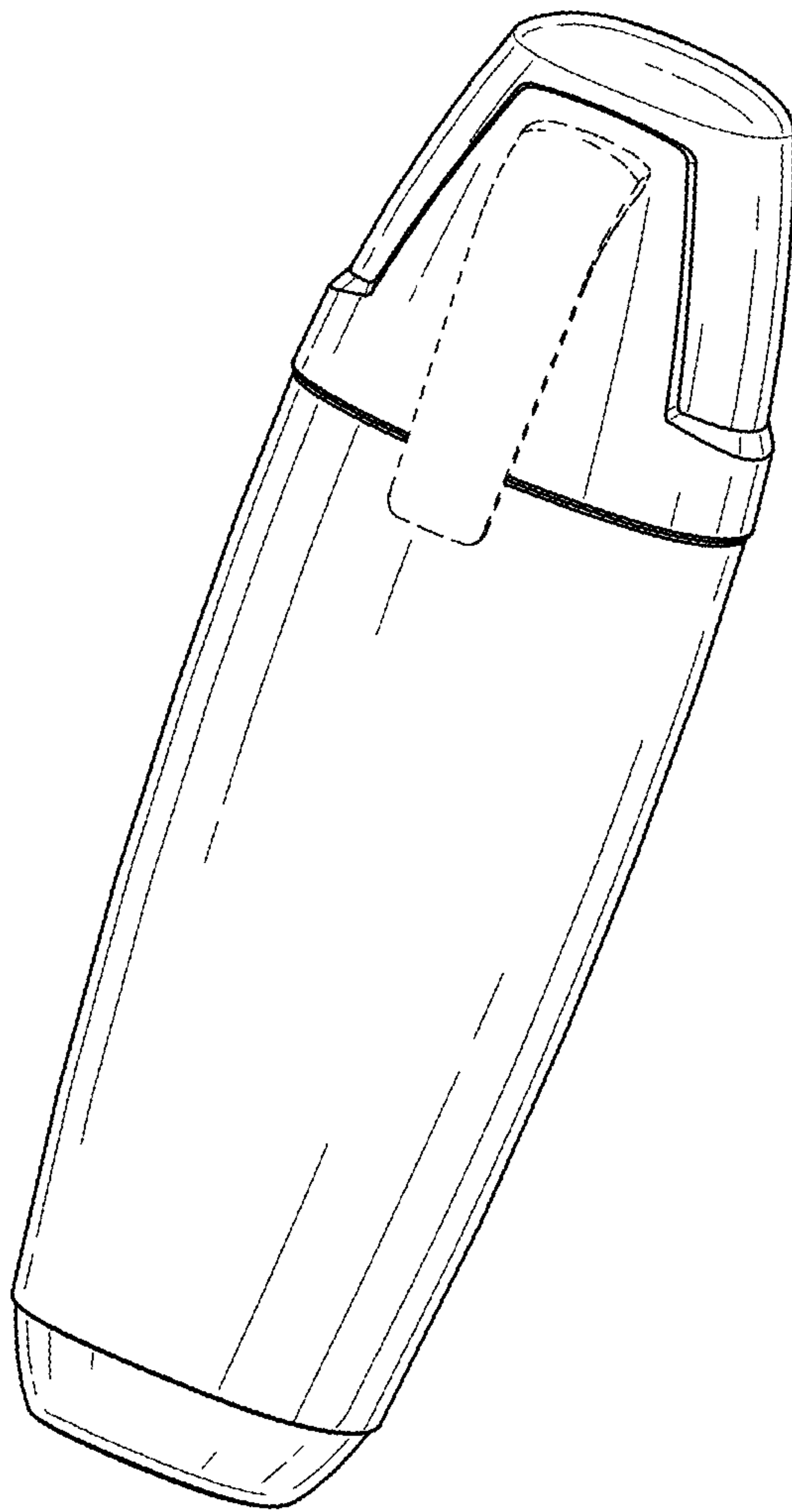

FIG. 2

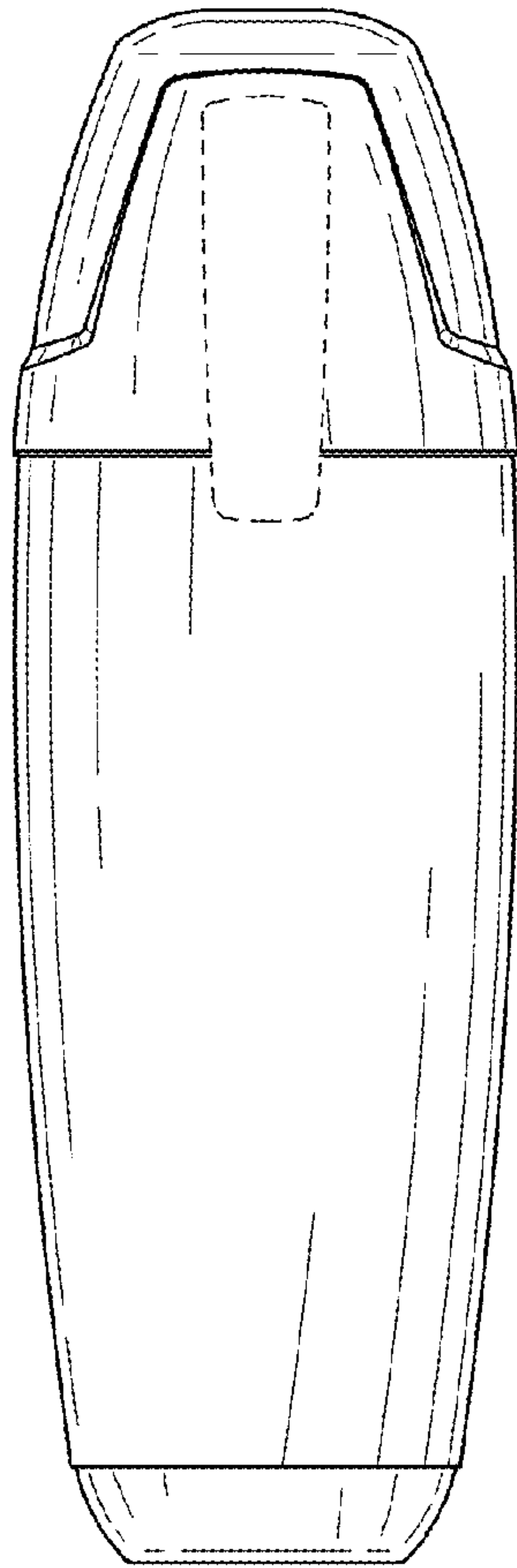

FIG. 3

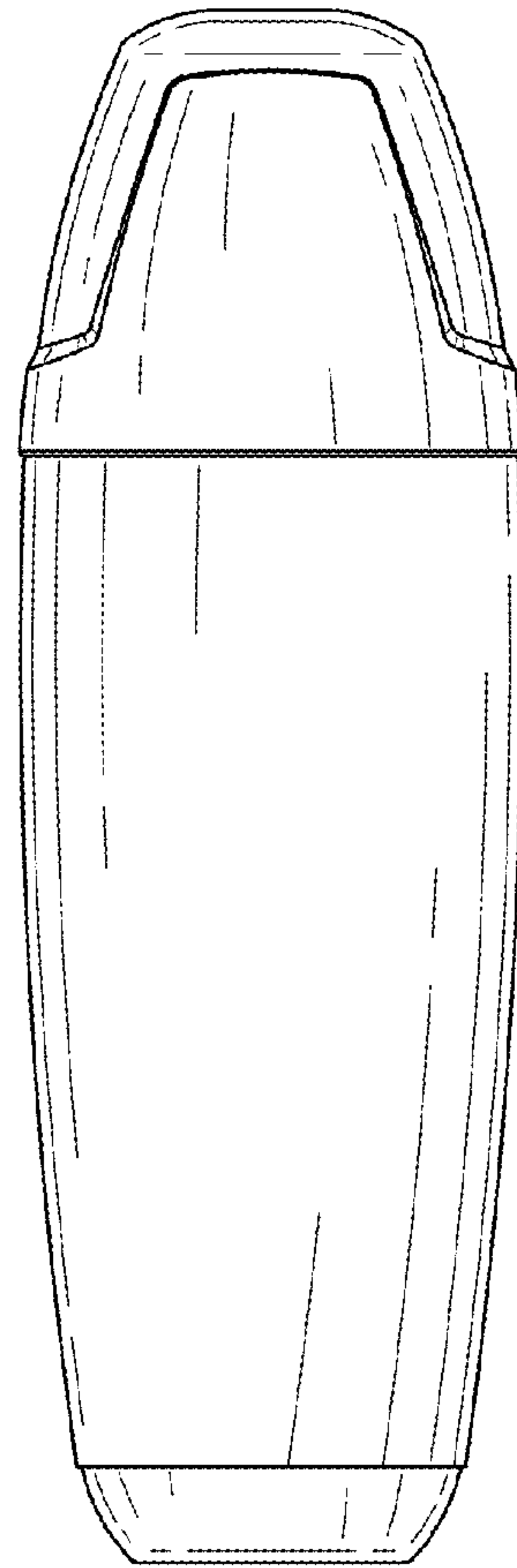

FIG. 4

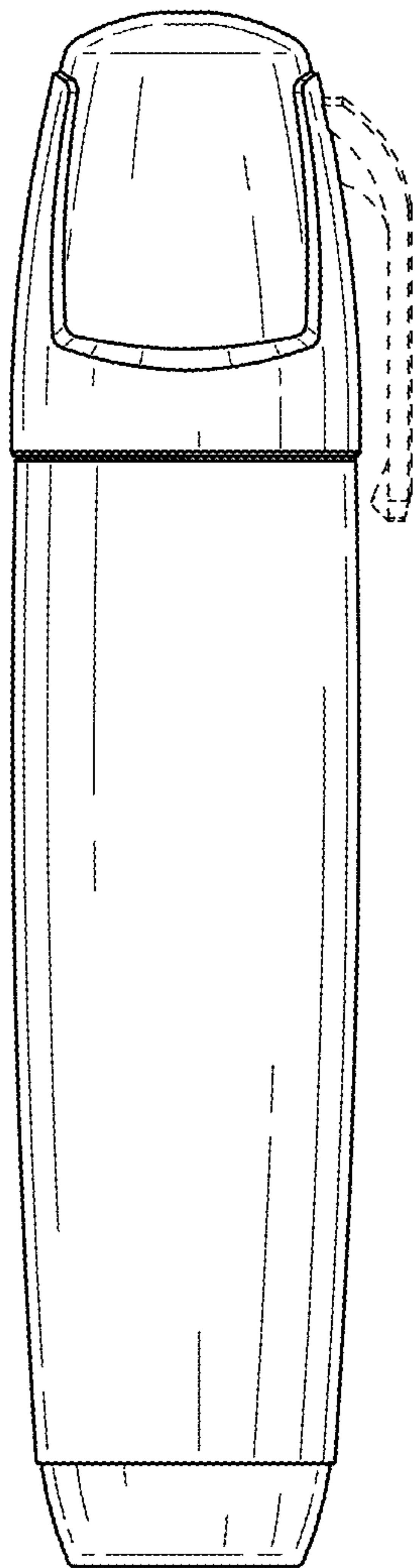

FIG. 5

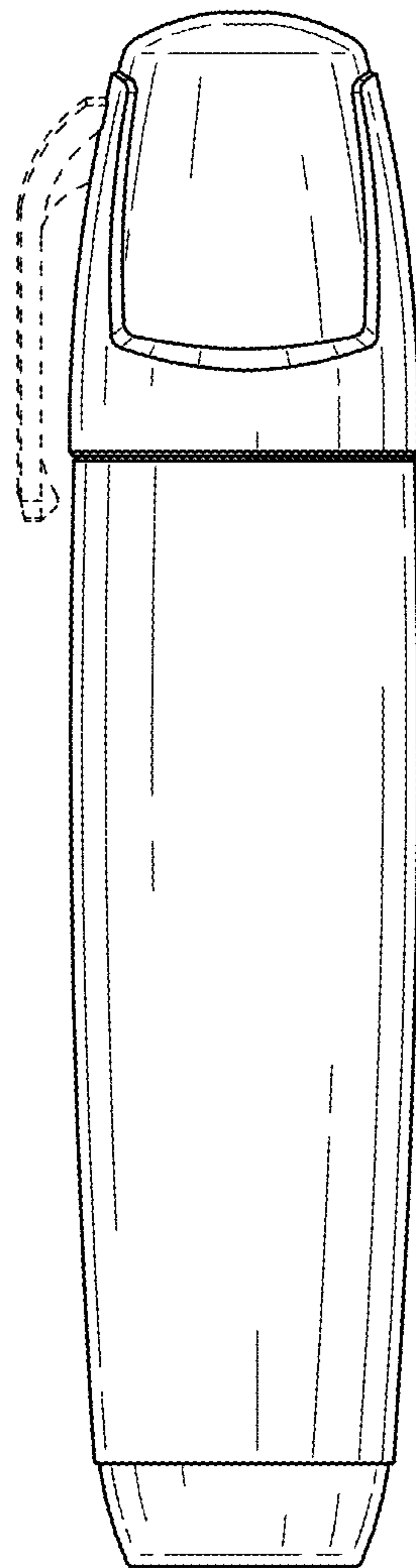

FIG. 6

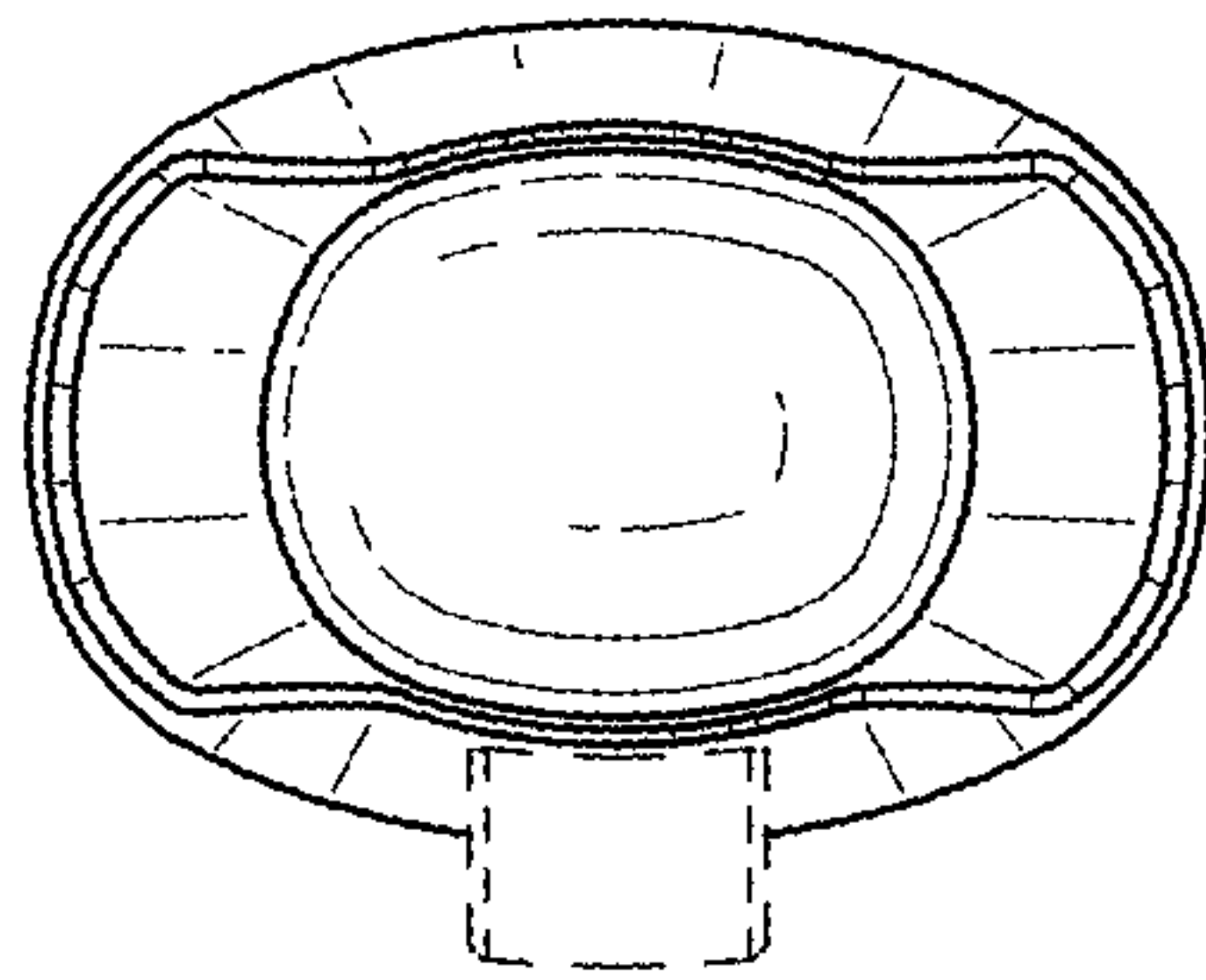

FIG. 7

