



US00D757694S

(12) **United States Design Patent**  
**Itai et al.**

(10) **Patent No.:** **US D757,694 S**  
(45) **Date of Patent:** **\*\* May 31, 2016**

- (54) **TELEVISION SET**
- (71) Applicant: **SHARP KABUSHIKI KAISHA**,  
Osaka-shi, Osaka (JP)
- (72) Inventors: **Noriaki Itai**, Osaka (JP); **Akihiko Hotta**, Osaka (JP); **Takeshi Koderu**, Osaka (JP); **Keiichi Takao**, Osaka (JP); **Lance Hussey**, Thousand Oaks, CA (US)
- (73) Assignee: **SHARP KABUSHIKI KAISHA**,  
Osaka-shi, Osaka (JP)
- (\*\*) Term: **14 Years**
- (21) Appl. No.: **29/513,526**
- (22) Filed: **Dec. 31, 2014**
- (51) **LOC (10) Cl.** ..... **14-03**
- (52) **U.S. Cl.**  
USPC ..... **D14/239**
- (58) **Field of Classification Search**  
USPC ..... D14/125–134, 239, 371, 136, 374–377,  
D14/440, 450, 448, 336, 342, 159; 312/7.2;  
348/836, 838, 180, 184, 325, 739;  
248/917–924, 465; 345/104, 133, 156,  
345/168, 87, 173; D21/329, 515, 577, 622,  
D21/333, 433, 448, 452, 450, 331, 505;  
D10/15, 26; 446/484, 175, 356;  
D6/477, 479, 300  
CPC ... G06F 1/1601; G06F 1/1643; H05K 5/0004;  
H05K 5/0017; H05K 5/02; H05K 5/0217  
See application file for complete search history.

- D342,497 S 12/1993 Saito et al.
- D342,501 S 12/1993 Saeki et al.
- D342,509 S 12/1993 Saito et al.
- D351,155 S 10/1994 Usami et al.
- D351,156 S 10/1994 Usami et al.
- D351,157 S 10/1994 Usami et al.
- D357,244 S 4/1995 Usami et al.
- D357,245 S 4/1995 Usami et al.
- D357,472 S 4/1995 Usami et al.
- D369,596 S 5/1996 Akiyama et al.
- D371,552 S 7/1996 Akiyama et al.

(Continued)

**OTHER PUBLICATIONS**

Design U.S. Appl. No. 29/446,834, filed Feb. 27, 2013, “Television Set”.

(Continued)

*Primary Examiner* — Randall Gholson

(74) *Attorney, Agent, or Firm* — Nixon & Vanderhye, P.C.

(57) **CLAIM**

The ornamental design for a “television set,” as shown and described.

**DESCRIPTION**

FIG. 1 is a front perspective view of a television set in accordance with our new design;  
 FIG. 2 is a front elevation view thereof;  
 FIG. 3 is rear elevation view thereof;  
 FIG. 4 is a top plan view thereof;  
 FIG. 5 is a bottom plan view thereof;  
 FIG. 6 is a right-side elevation view thereof; and  
 FIG. 7 is a left-side elevation view thereof.  
 FIG. 8 is a right side sectioned view taken along line 8-8 of FIG. 2, omitting internal structure; and,  
 FIG. 9 is a top sectioned view taken along line 9-9 of FIG. 2, omitting internal structure.  
 Subject matter shown in dashed lines is for environmental purposes only and forms no part of the claimed invention.

**1 Claim, 7 Drawing Sheets**

(56) **References Cited**  
U.S. PATENT DOCUMENTS

- D336,645 S 6/1993 Saito et al.
- D336,960 S 6/1993 Bedell
- D337,113 S 7/1993 Saito et al.
- D338,668 S 8/1993 Saito et al.

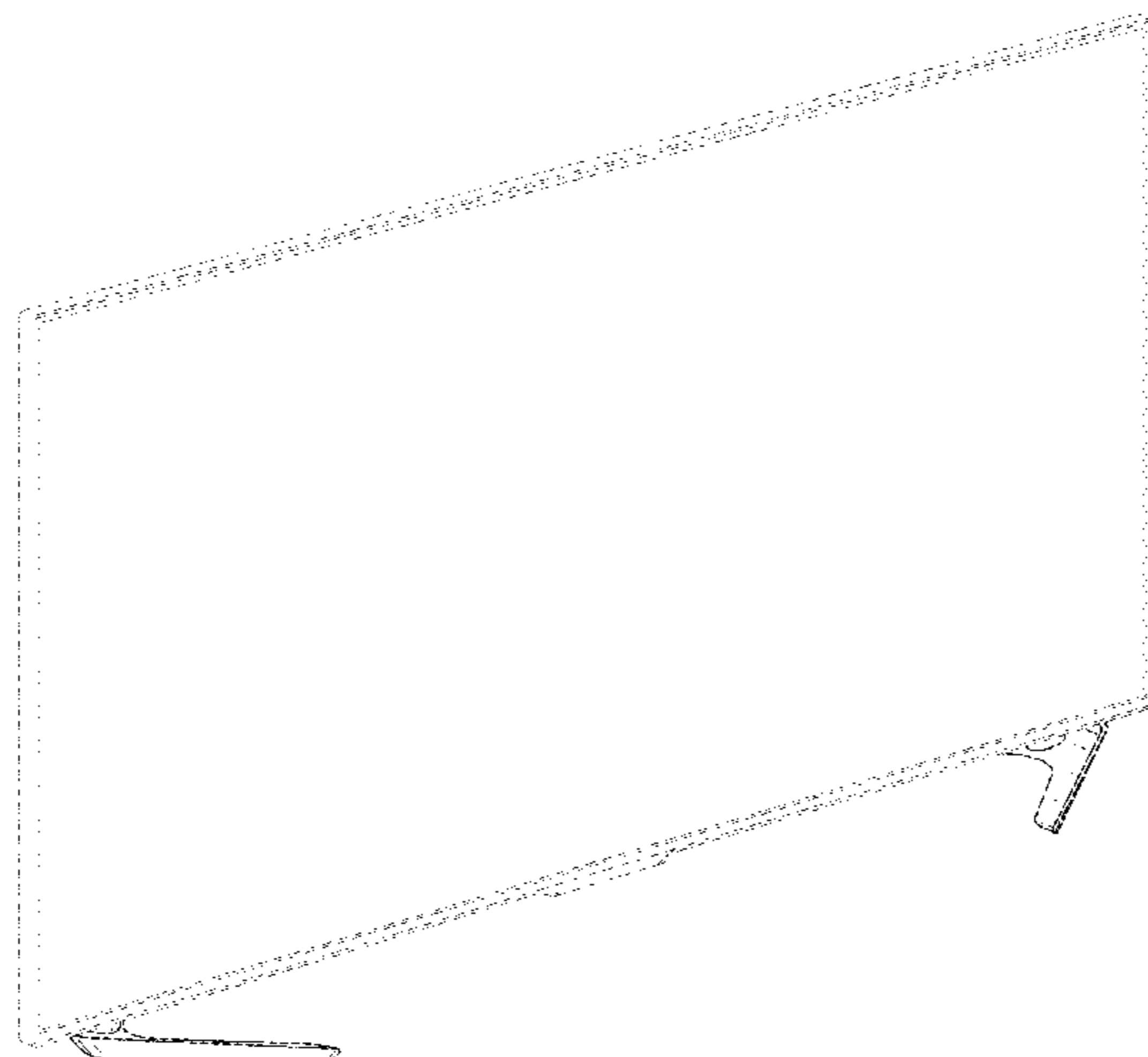

(56)

References Cited

U.S. PATENT DOCUMENTS

D372,026 S 7/1996 Akiyama et al.  
 D373,583 S 9/1996 Akiyama et al.  
 D427,169 S 6/2000 Saeki et al.  
 D429,227 S 8/2000 Shimizu  
 D431,537 S 10/2000 Saeki et al.  
 D438,848 S 3/2001 Kita  
 D439,224 S 3/2001 Kita  
 D439,225 S 3/2001 Kita  
 D453,747 S 2/2002 Kita  
 D453,748 S 2/2002 Kita  
 D456,370 S 4/2002 Kita  
 D458,910 S 6/2002 Kita  
 D492,269 S 6/2004 Kita  
 D496,915 S 10/2004 Kita  
 D497,351 S 10/2004 Kita  
 D497,599 S 10/2004 Kita  
 D499,076 S 11/2004 Kita  
 D501,186 S 1/2005 Kita  
 D501,654 S 2/2005 Kita  
 D502,451 S 3/2005 Kita  
 D502,931 S 3/2005 Kita  
 D505,123 S 5/2005 Kita  
 D505,403 S 5/2005 Kita  
 D510,731 S 10/2005 Kita  
 D512,385 S 12/2005 Kita  
 D512,386 S 12/2005 Kita  
 D512,387 S 12/2005 Kita  
 D536,678 S 2/2007 Kita  
 D538,242 S 3/2007 Kita  
 D538,762 S 3/2007 Fujii et al.  
 D538,763 S 3/2007 Fujii et al.  
 D539,766 S 4/2007 Kita  
 D540,281 S 4/2007 Kita  
 D540,282 S 4/2007 Kita  
 D540,284 S 4/2007 Kita  
 D540,285 S 4/2007 Kita  
 D541,237 S 4/2007 Kita  
 D541,240 S 4/2007 Kita  
 D541,766 S 5/2007 Kita  
 D541,772 S 5/2007 Kita  
 D541,774 S 5/2007 Kita  
 D541,775 S 5/2007 Kita  
 D543,519 S 5/2007 Kita  
 D544,850 S 6/2007 Kita  
 D545,282 S 6/2007 Kita  
 D545,775 S 7/2007 Kita  
 D545,779 S 7/2007 Kita  
 D545,780 S 7/2007 Kita  
 D546,301 S 7/2007 Kita  
 D546,302 S 7/2007 Kita  
 D546,303 S 7/2007 Fujii et al.  
 D551,187 S 9/2007 Kita  
 D552,050 S 10/2007 Fujii et al.  
 D552,569 S 10/2007 Kita  
 D552,571 S 10/2007 Fujii et al.

D554,085 S 10/2007 Kita  
 D562,275 S 2/2008 Iinuma et al.  
 D564,989 S 3/2008 Kita  
 D566,067 S 4/2008 Kita  
 D567,197 S 4/2008 Kita  
 D568,264 S 5/2008 Fujii et al.  
 D568,265 S 5/2008 Fujii et al.  
 D568,266 S 5/2008 Shimamoto  
 D568,844 S 5/2008 Fujii et al.  
 D570,311 S 6/2008 Kita  
 D570,312 S 6/2008 Kita  
 D571,320 S 6/2008 Kita  
 D575,248 S 8/2008 Fujii et al.  
 D584,255 S 1/2009 Kita  
 D584,256 S 1/2009 Kita  
 D584,257 S 1/2009 Kita  
 D584,702 S 1/2009 Iinuma et al.  
 D584,705 S 1/2009 Shimamoto  
 D585,396 S 1/2009 Kita  
 D586,769 S 2/2009 Kita  
 D637,168 S 5/2011 Kodera et al.  
 D638,388 S 5/2011 Fujii et al.  
 D656,472 S 3/2012 Iida et al.  
 D657,327 S 4/2012 Iida et al.  
 D661,270 S \* 6/2012 Cha et al. .... D14/126  
 D664,940 S \* 8/2012 Kim et al. .... D14/129  
 D671,923 S \* 12/2012 Seong et al. .... D14/239  
 D678,230 S 3/2013 Yamamizu et al.  
 D679,671 S 4/2013 Fujii et al.  
 D679,672 S 4/2013 Fujii et al.  
 D680,087 S 4/2013 Fujii et al.  
 D680,106 S \* 4/2013 Hwangbo et al. .... D14/239  
 D687,000 S 7/2013 Gomi et al.  
 8,537,531 B2 \* 9/2013 Gotham et al. .... 361/679.21  
 D691,573 S 10/2013 Iida et al.  
 D691,976 S 10/2013 Hotta et al.  
 D694,208 S \* 11/2013 Duys et al. .... D14/126  
 D694,210 S 11/2013 Fujii et al.  
 D695,027 S \* 12/2013 Zadro ..... D6/300  
 D705,200 S \* 5/2014 Choi ..... D14/239  
 D708,157 S \* 7/2014 Park ..... D14/126  
 D708,596 S \* 7/2014 Park ..... D14/126  
 D716,244 S \* 10/2014 Kim et al. .... D14/126

OTHER PUBLICATIONS

Design U.S. Appl. No. 29/472,802, filed Nov. 15, 2013, "Television Set".  
 Design U.S. Appl. No. 29/489,624, filed May 1, 2014, "Television Set".  
 Design U.S. Appl. No. 29/489,746, filed May 2, 2014, entitled "Television Set".  
 Design U.S. Appl. No. 29/510,770, filed Dec. 3, 2014, entitled "Television Set".  
 Design U.S. Appl. No. 29/511,565, filed Dec. 11, 2014, entitled "Television Set".

\* cited by examiner

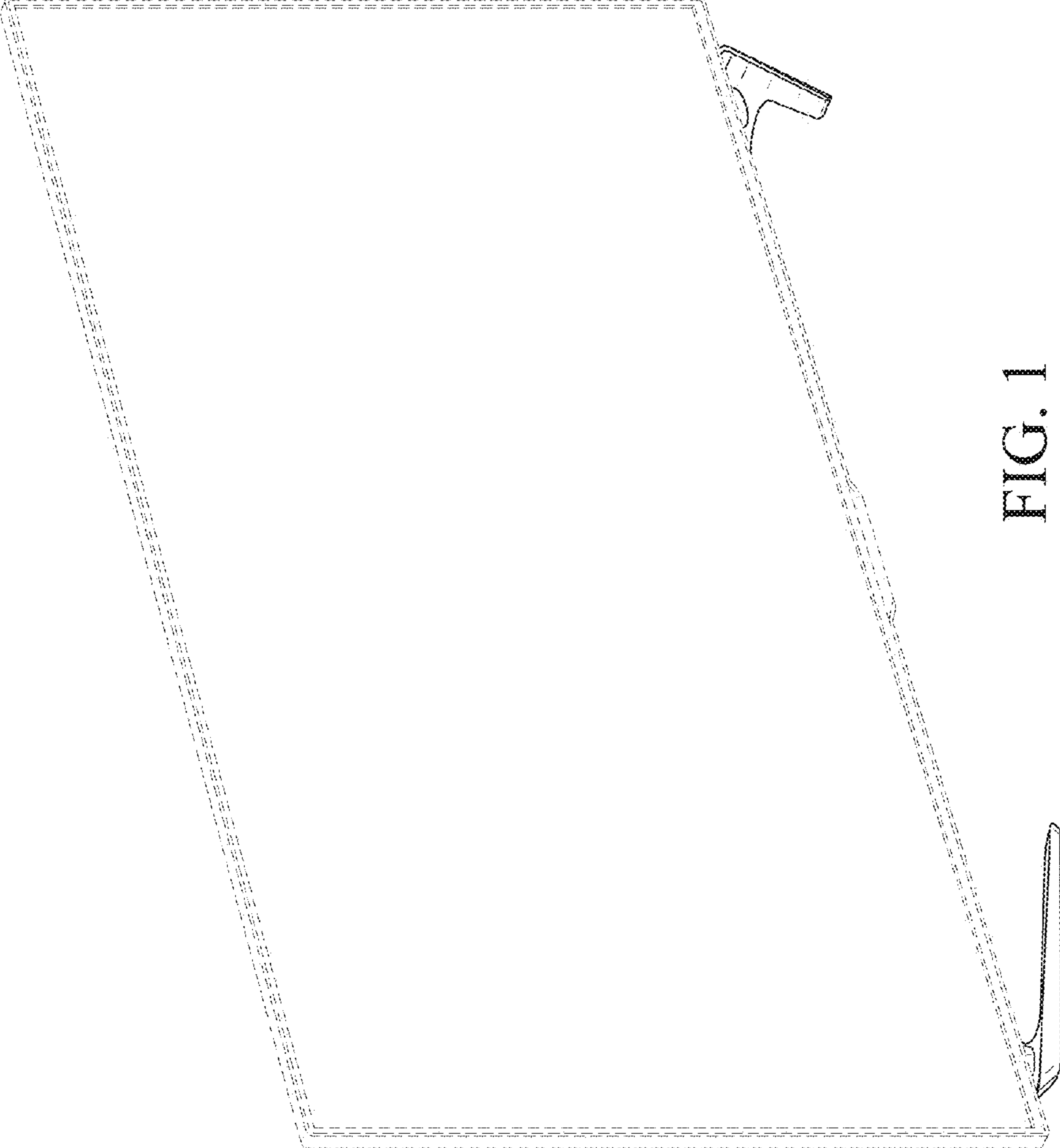

FIG. 1

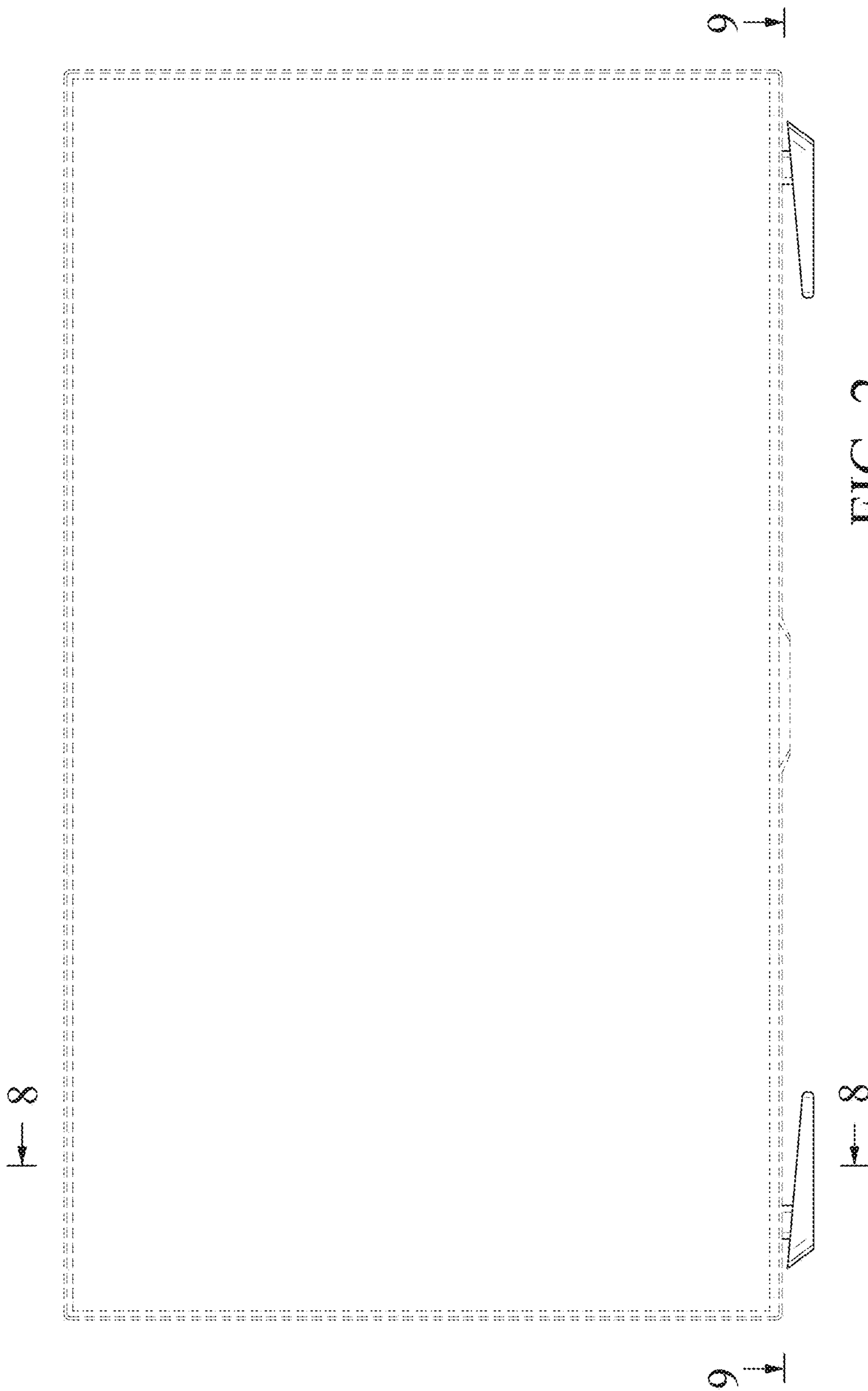

FIG. 2

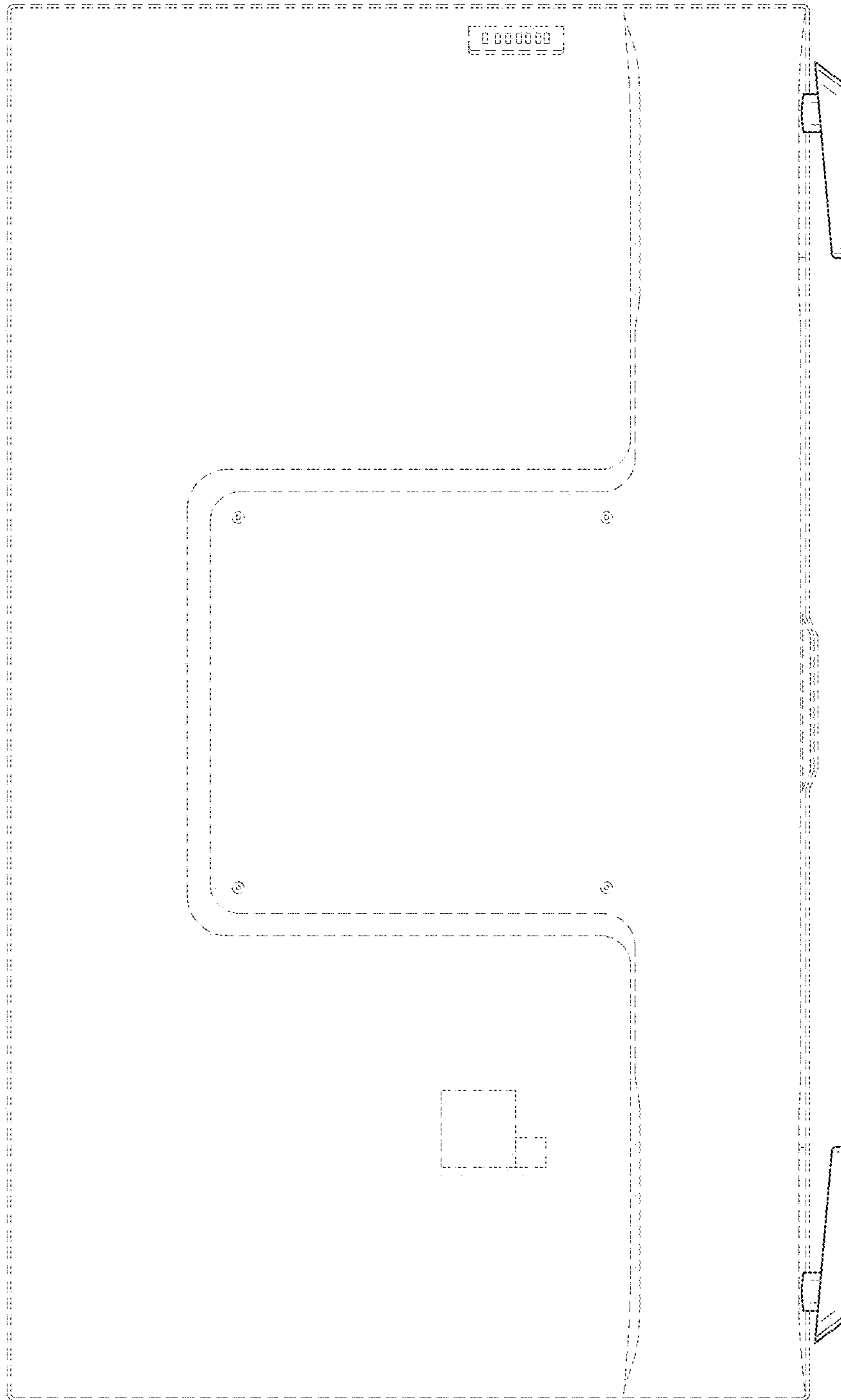
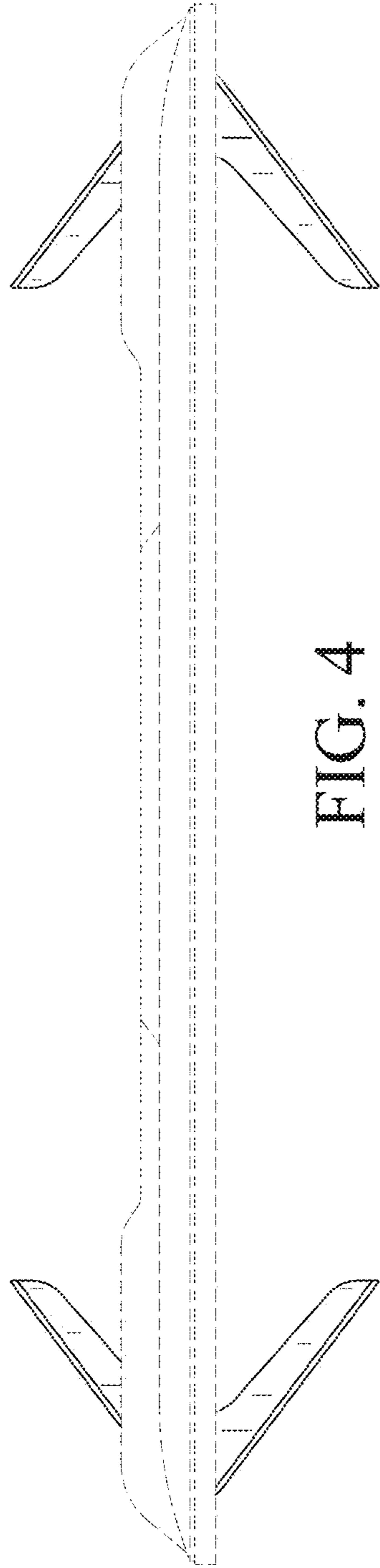

FIG. 3



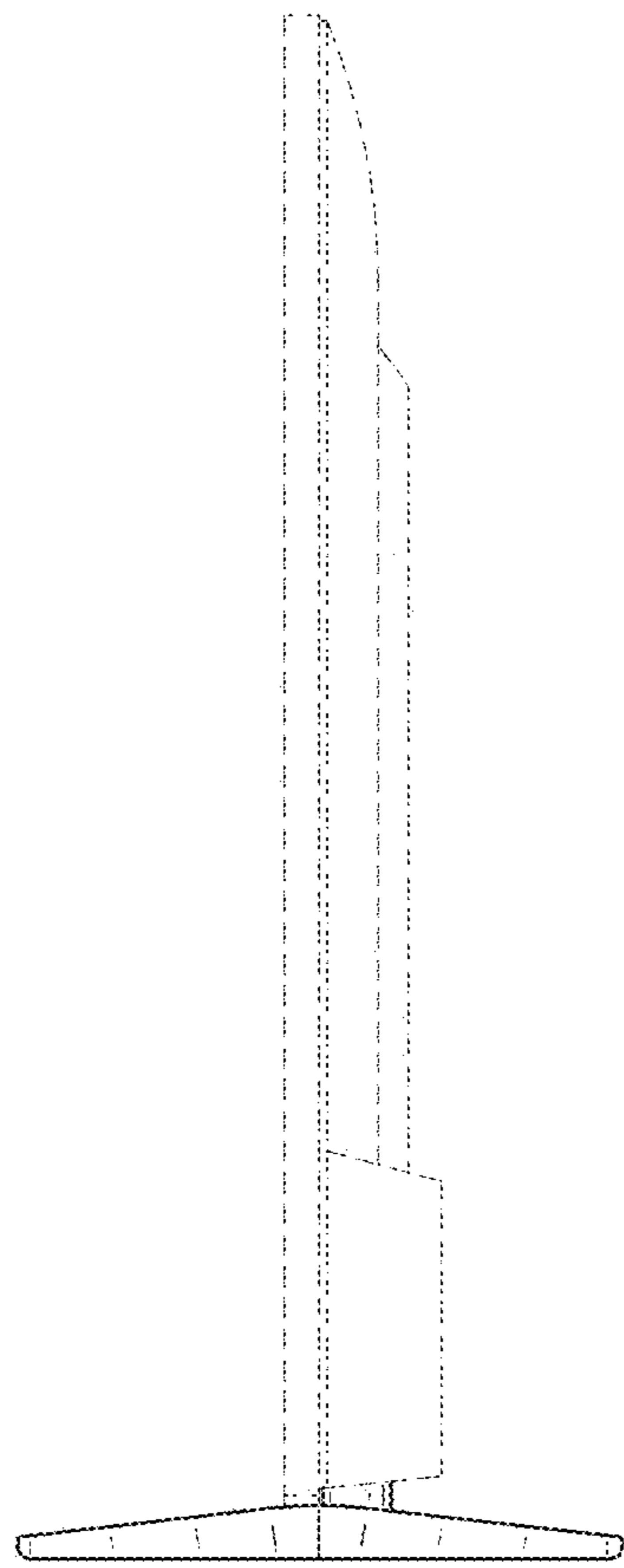

FIG. 6

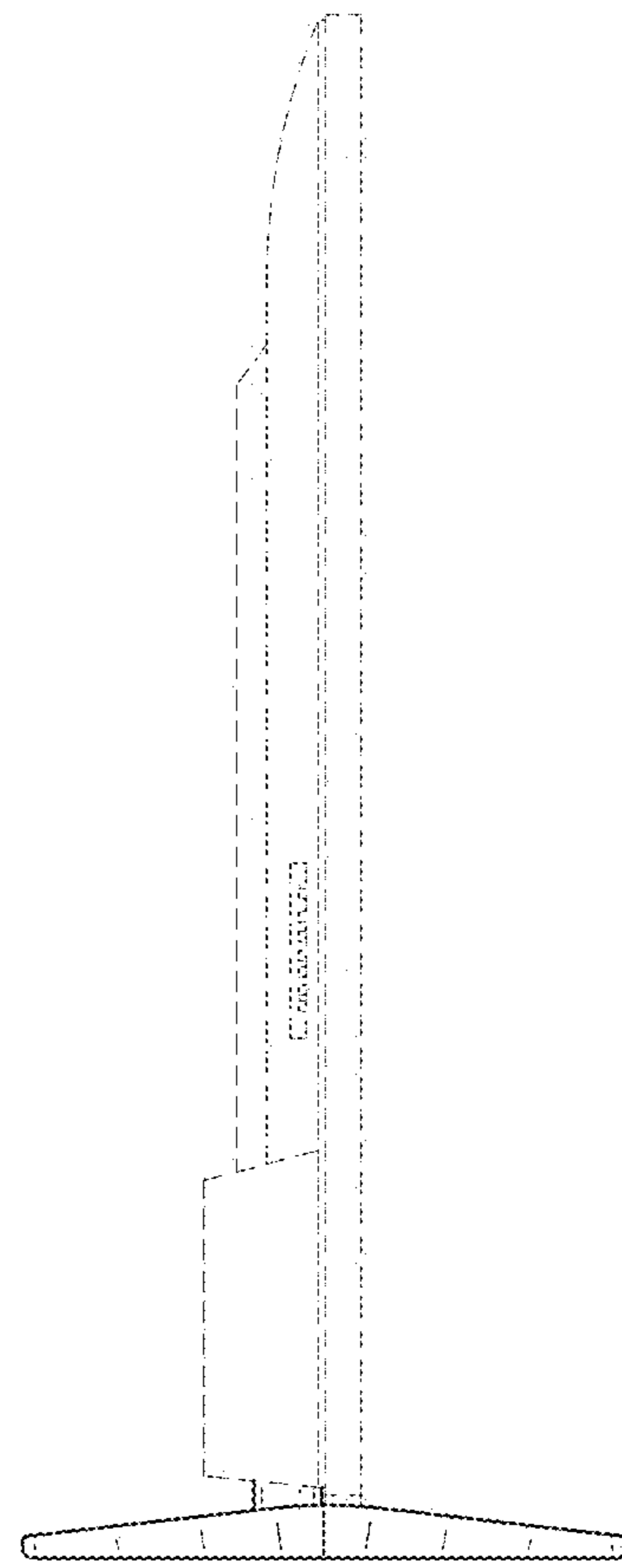

FIG. 7

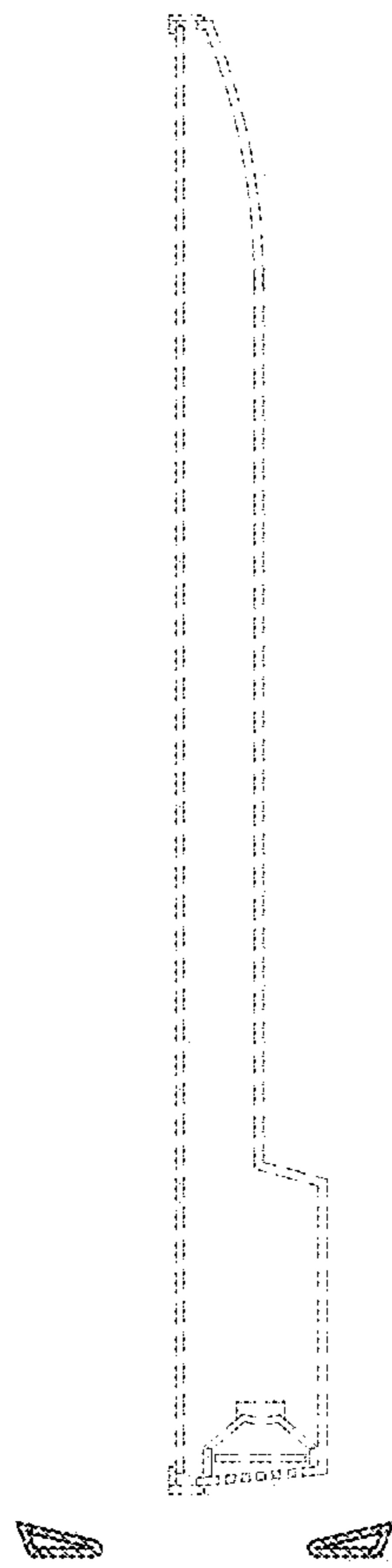

FIG. 8



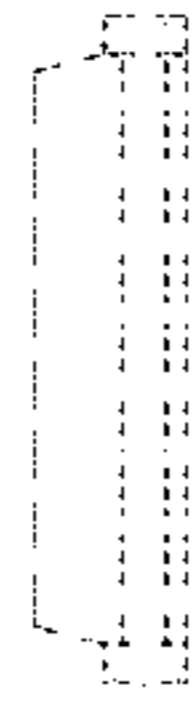
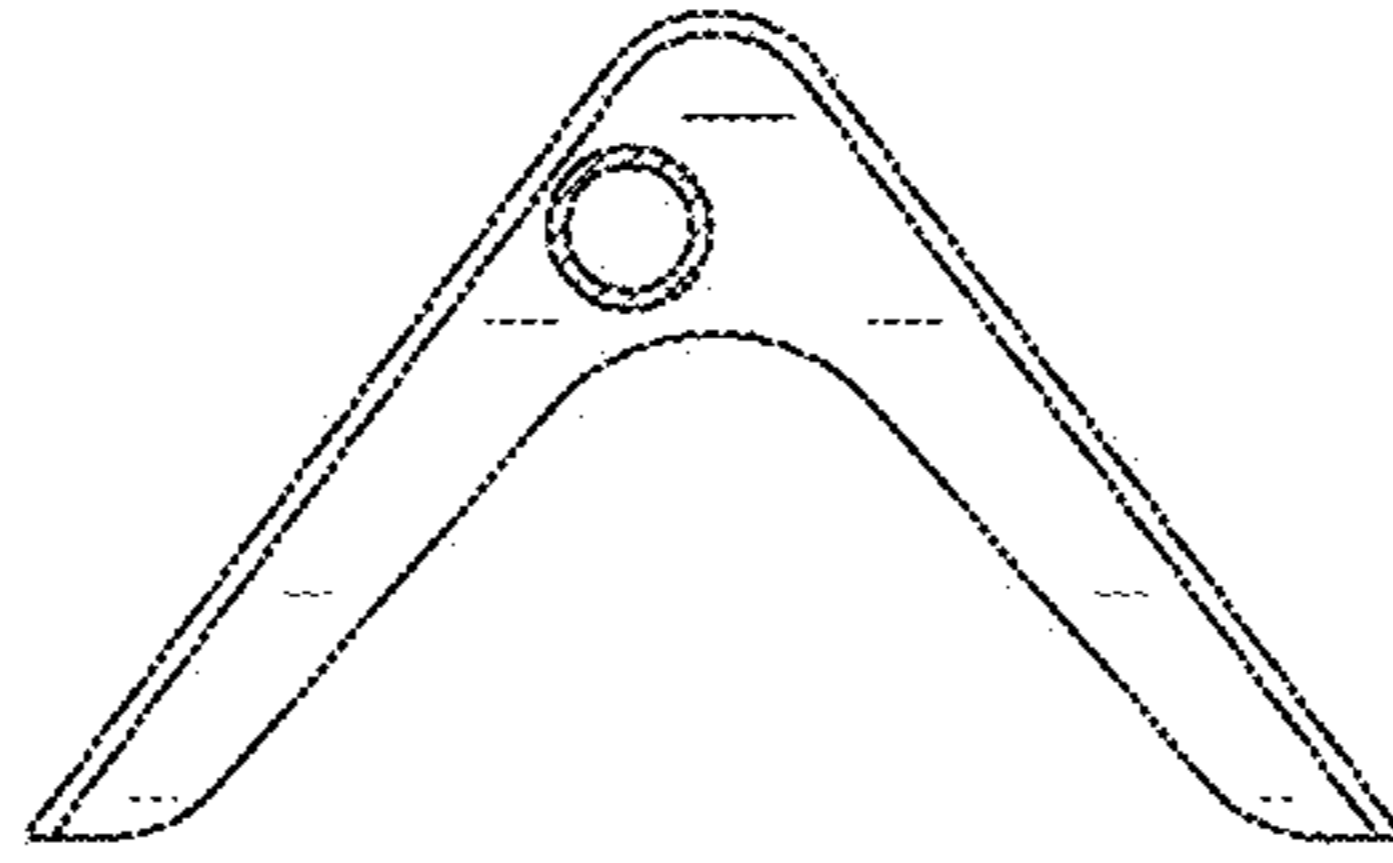

FIG. 9

