



US00D757677S

(12) **United States Design Patent**  
**Hutt et al.**

(10) **Patent No.:** **US D757,677 S**  
(45) **Date of Patent:** **\*\* May 31, 2016**

- (54) **TELEPHONE DESK SET**
- (71) Applicants: **Daron Hutt**, Christchurch (GB); **Roland Irving**, Christchurch (GB)
- (72) Inventors: **Daron Hutt**, Christchurch (GB); **Roland Irving**, Christchurch (GB)
- (73) Assignee: **4COM PLC**, Christchurch (GB)
- (\*\*) Term: **14 Years**
- (21) Appl. No.: **29/497,933**
- (22) Filed: **Jul. 30, 2014**
- (51) **LOC (10) Cl.** ..... **14-03**
- (52) **U.S. Cl.**  
USPC ..... **D14/151**
- (58) **Field of Classification Search**  
USPC ..... D14/137, 140, 142, 144, 147-151, 240,  
D14/244, 251, 252, 257; 379/419, 434-436,  
379/440, 446, 454, 455; 455/90.3, 550.1  
See application file for complete search history.

- D723,502 S \* 3/2015 Chun ..... D14/130
- D723,503 S \* 3/2015 Jeon ..... D14/130
- D725,623 S \* 3/2015 Hartmann ..... D14/140
- D729,758 S \* 5/2015 Okita ..... D14/151
- D733,675 S \* 7/2015 Jeon ..... D14/151
- D734,289 S \* 7/2015 Jeon ..... D14/142

**FOREIGN PATENT DOCUMENTS**

CN 3328003 \* 10/2003  
\* cited by examiner

*Primary Examiner* — Susan Bennett Hattan  
*Assistant Examiner* — Leanne Was

(74) *Attorney, Agent, or Firm* — Ober, Kaler, Grimes & Shriver; Royal W. Craig

(57) **CLAIM**

The ornamental design for a telephone desk set, as shown and described.

**DESCRIPTION**

FIG. 1 is a front perspective view of the telephone desk set showing our new design.  
 FIG. 2 is front view of the of the telephone desk set of FIG. 1.  
 FIG. 3 is a left side view of the telephone desk set of FIGS. 1-2.  
 FIG. 4 is a right side view of the telephone desk set of FIGS. 1-3.  
 FIG. 5 is a rear perspective view of the telephone desk set of FIGS. 1-4 thereof; and,  
 FIG. 6 is a bottom plan view of the telephone desk set of FIGS. 1-5.  
 The broken lines depict portions of the telephone desk set that form no part of the claimed design.

**1 Claim, 5 Drawing Sheets**

(56) **References Cited**

**U.S. PATENT DOCUMENTS**

- D323,156 S \* 1/1992 Nishida ..... D14/144
- D324,036 S \* 2/1992 Wakasa ..... D14/144
- D393,858 S \* 4/1998 Backs ..... D14/149
- D585,397 S \* 1/2009 Hwang ..... D14/130
- 7,778,411 B2 \* 8/2010 Dedieu ..... H04M 1/03  
379/428.02
- D652,816 S \* 1/2012 Compoginis ..... D14/151
- D675,592 S \* 2/2013 Fuxen ..... D14/151
- D686,184 S \* 7/2013 Takahata ..... D14/151
- D717,762 S \* 11/2014 Jeon ..... D14/130

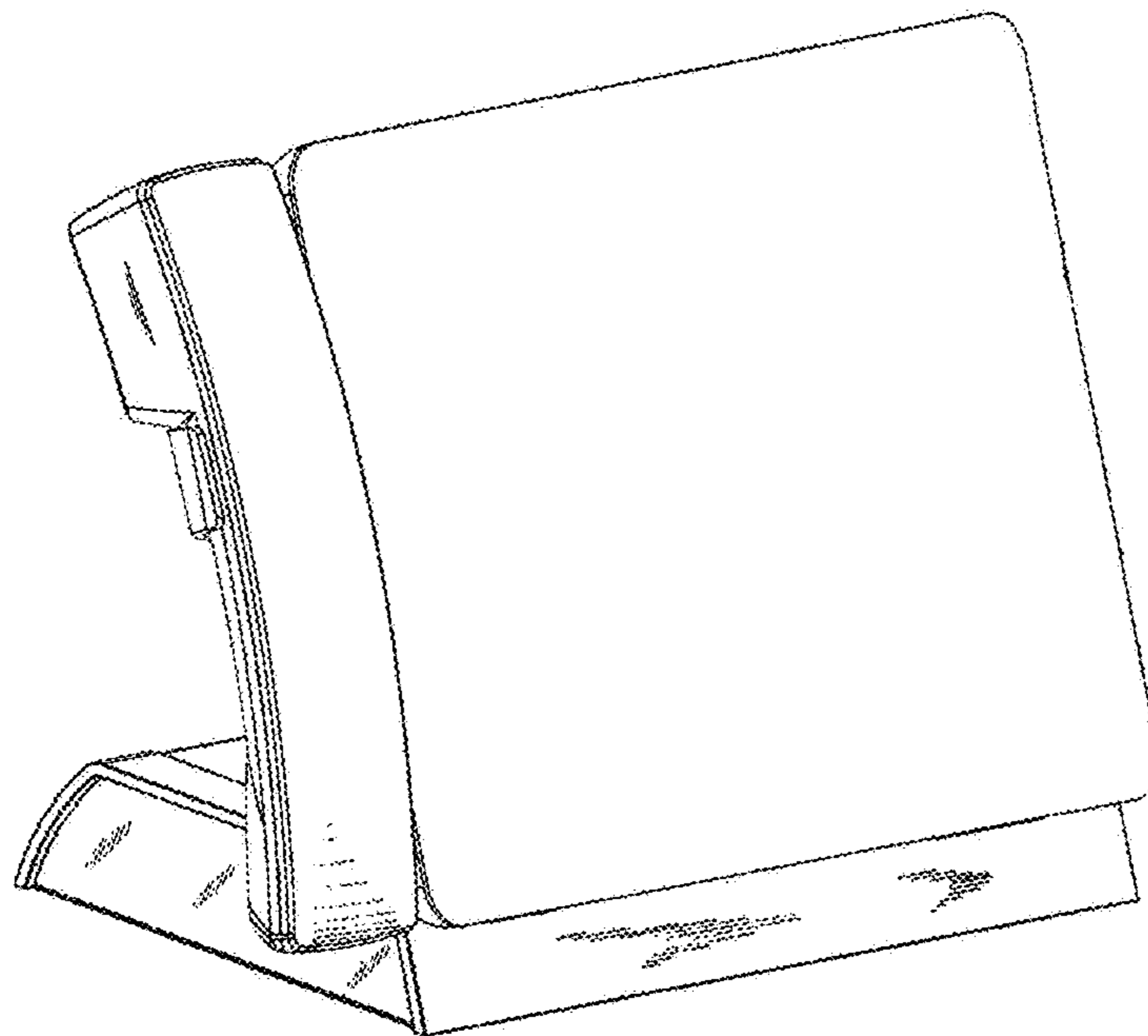

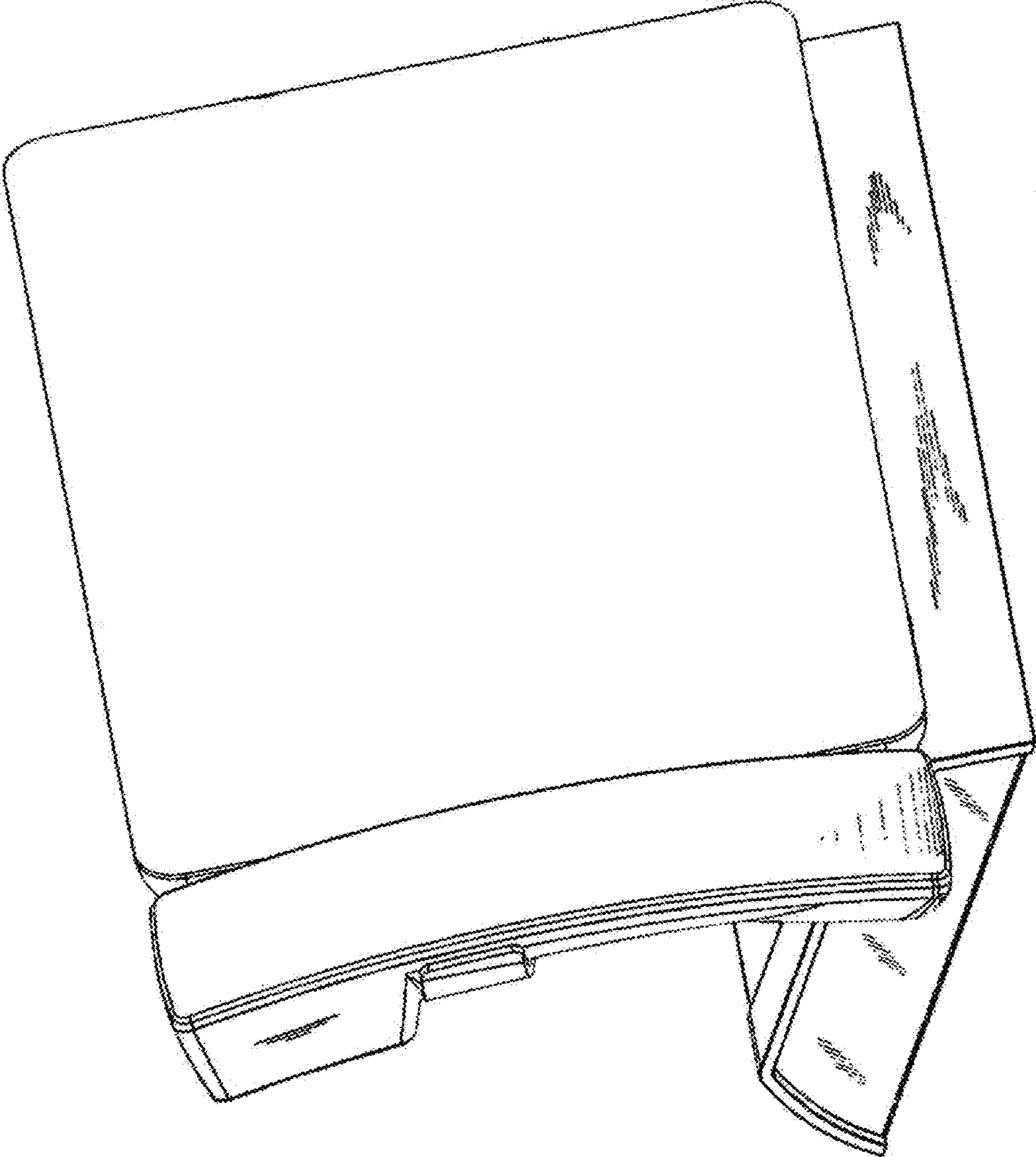

FIG. 1

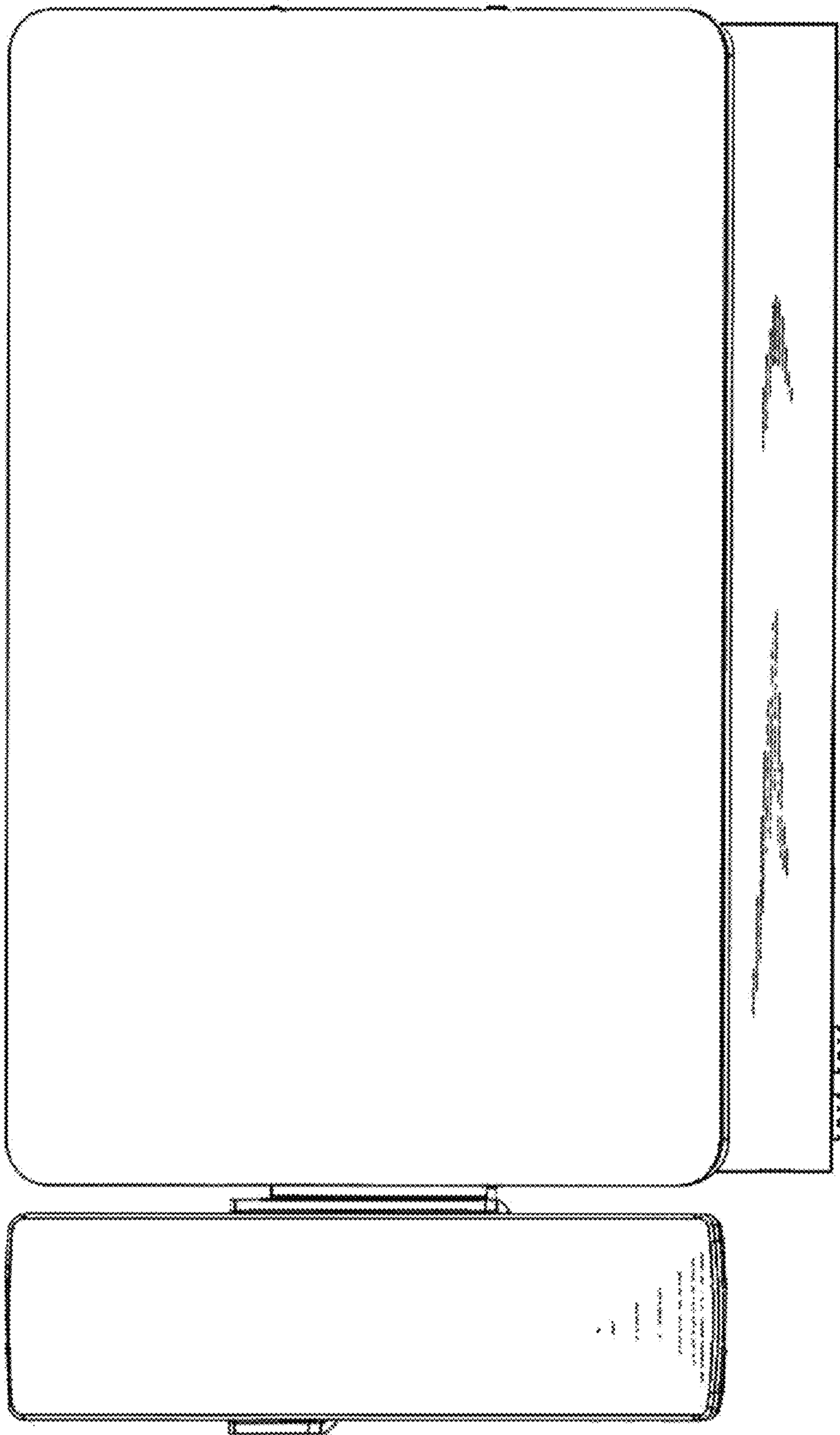

FIG. 2

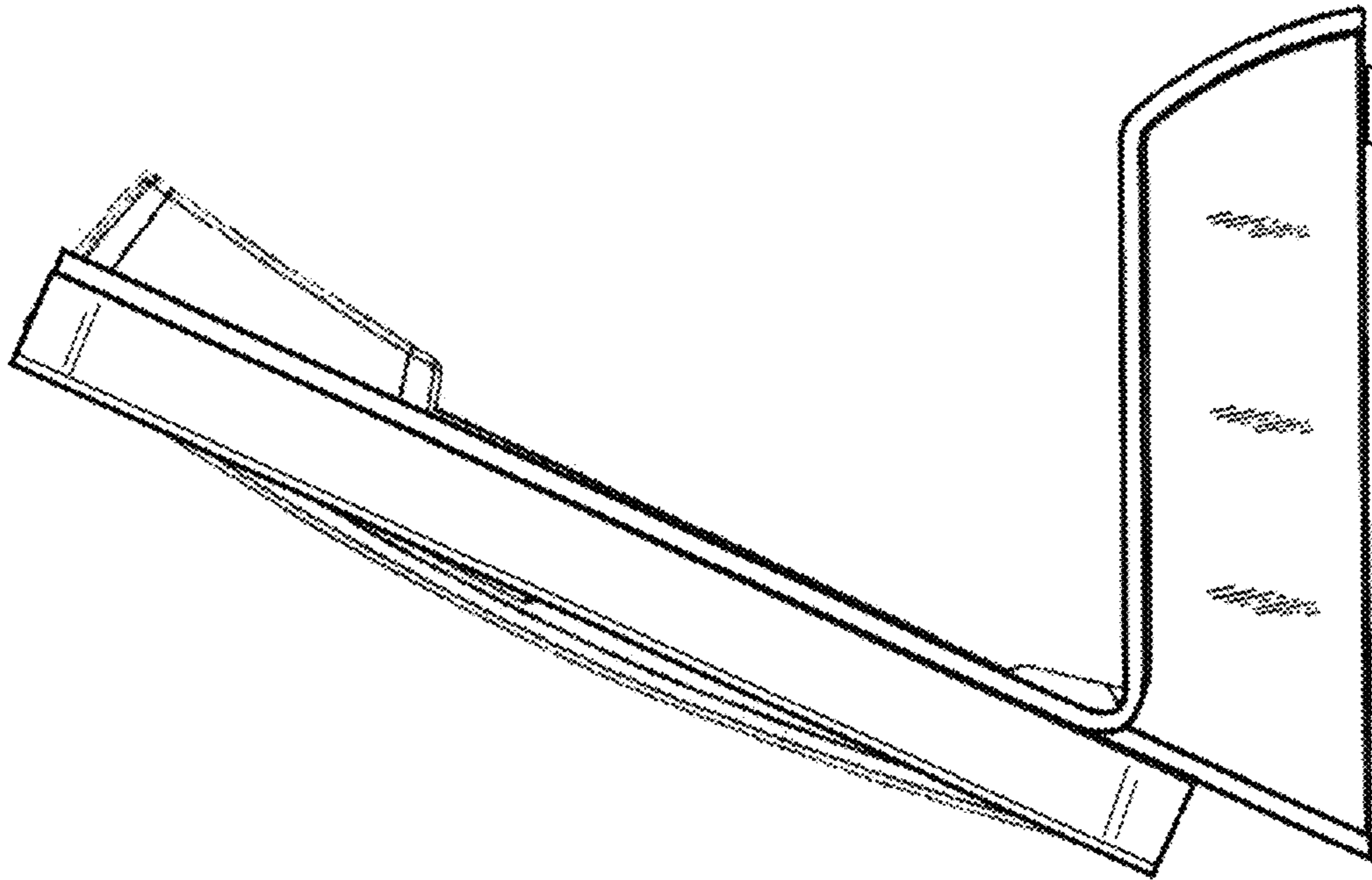

FIG. 4

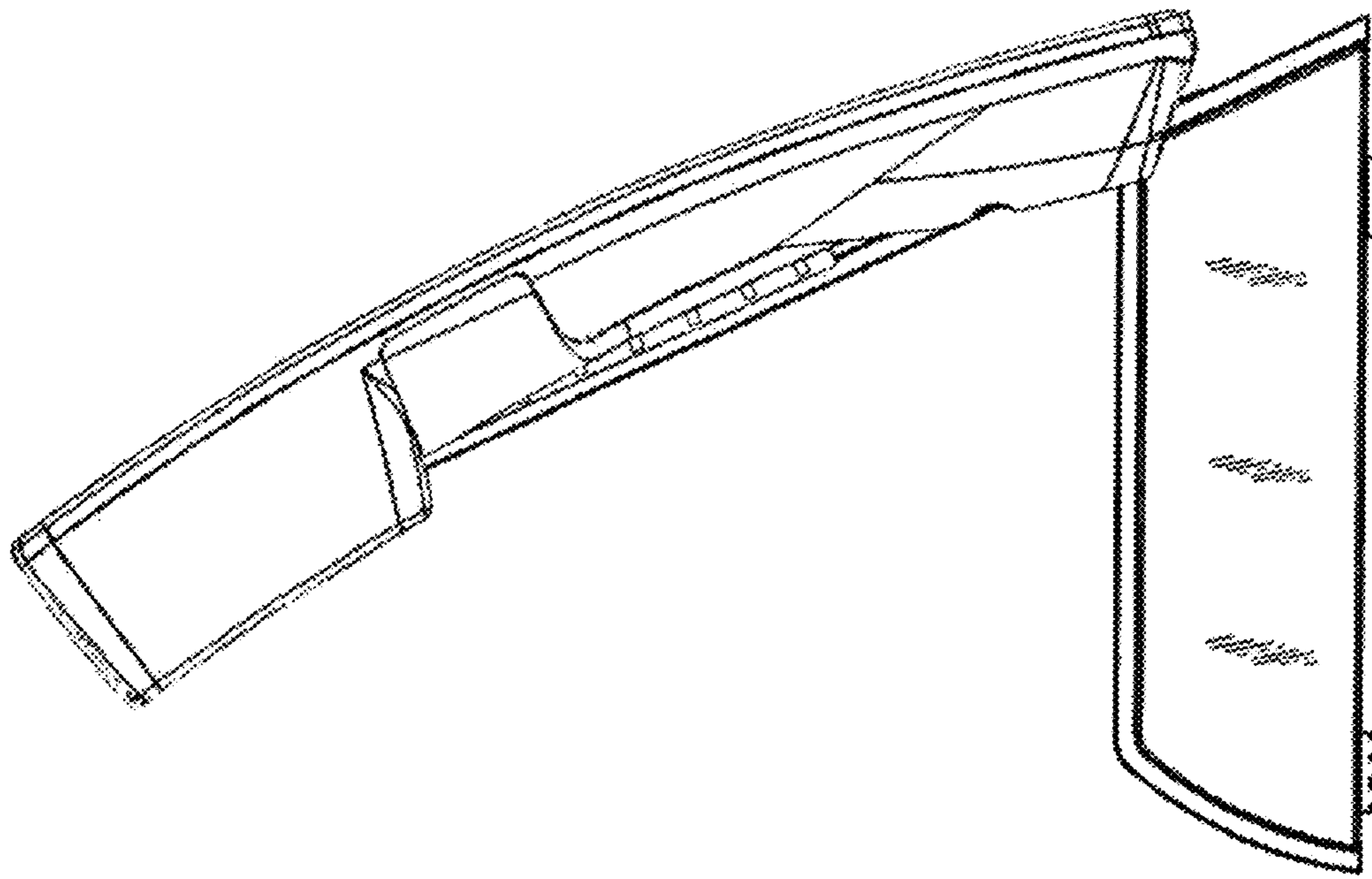

FIG. 3

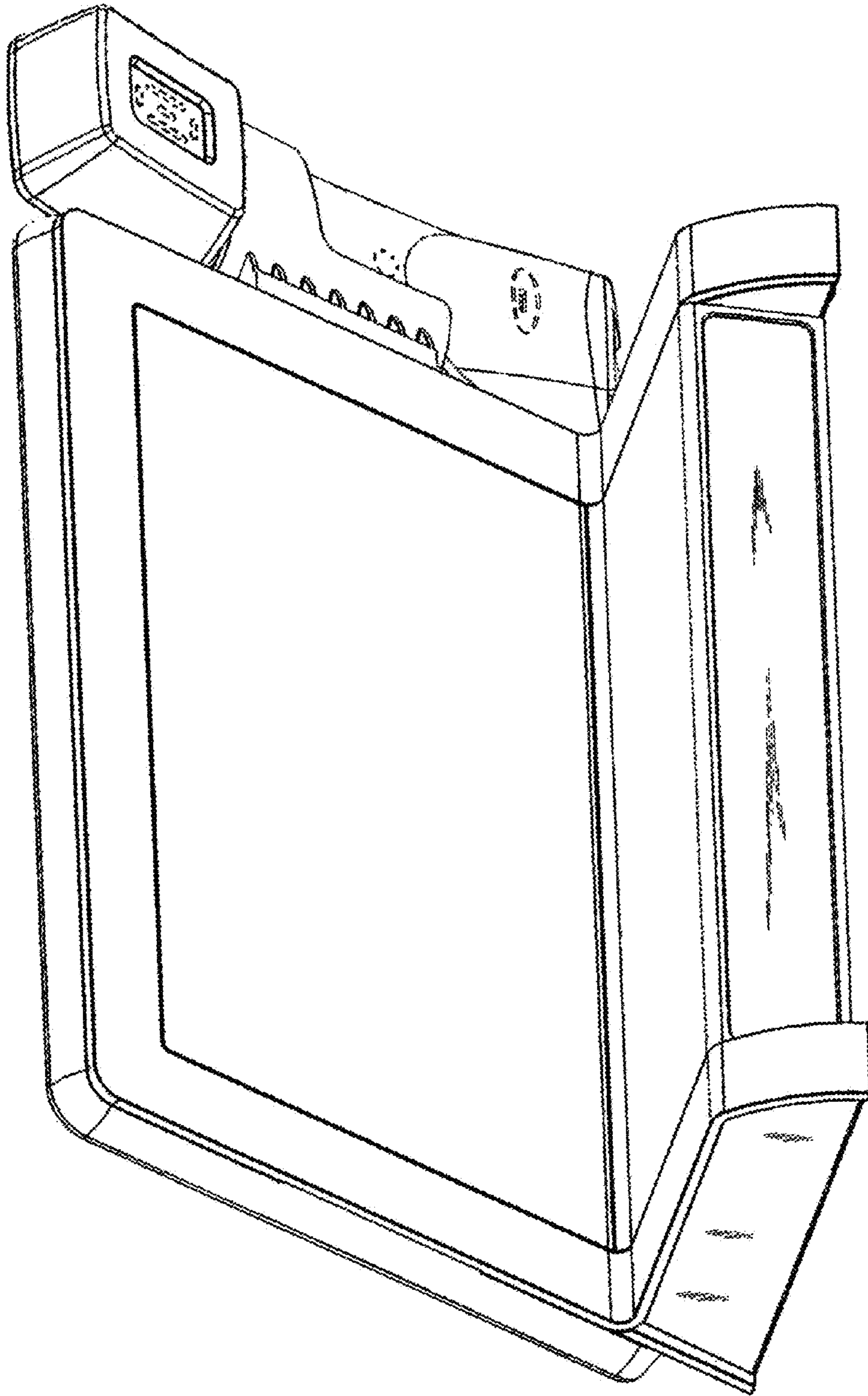

FIG. 5

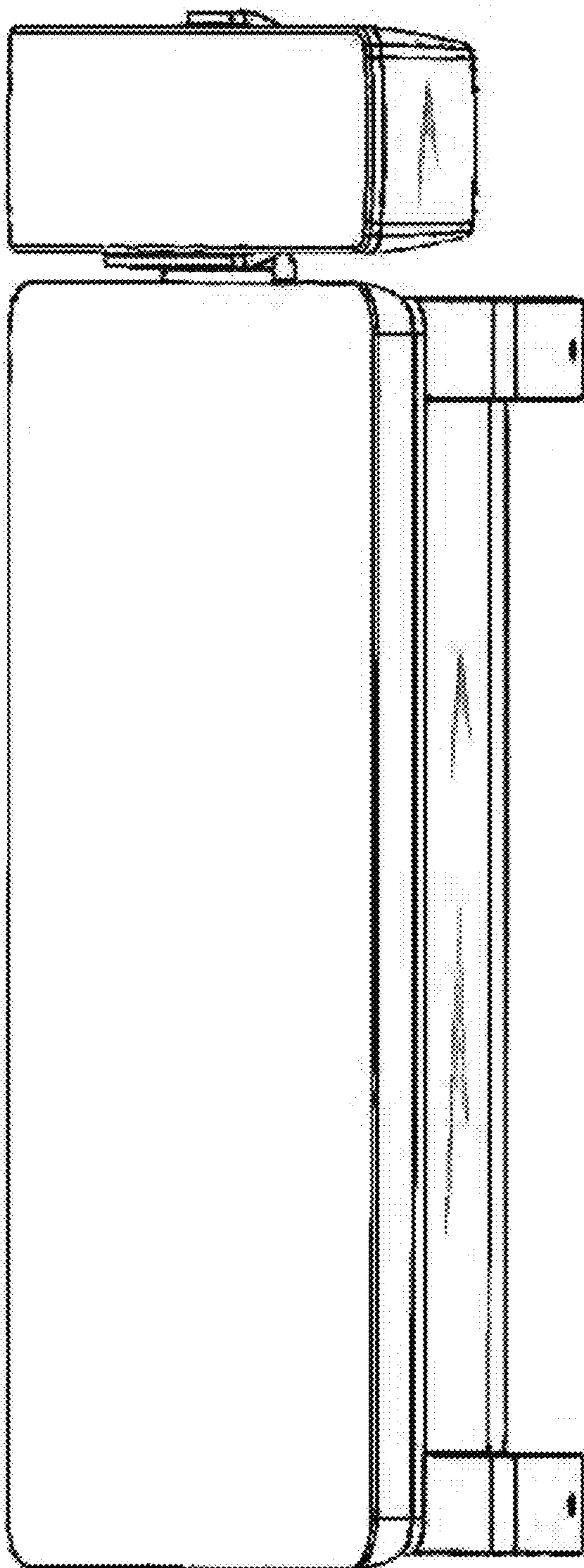

FIG. 6