



US00D757590S

(12) **United States Design Patent**  
**Akana et al.**

(10) **Patent No.:** **US D757,590 S**  
(45) **Date of Patent:** **\*\* May 31, 2016**

(54) **BAND**

(71) Applicant: **Apple Inc.**, Cupertino, CA (US)

(72) Inventors: **Jody Akana**, San Francisco, CA (US);  
**Bartley K. Andre**, Palo Alto, CA (US);  
**Shota Aoyagi**, San Francisco, CA (US);  
**Anthony Michael Ashcroft**, San Francisco, CA (US);  
**Jeremy Bataillou**, San Francisco, CA (US);  
**Daniel J. Coster**, San Francisco, CA (US);  
**Daniele De Iuliis**, San Francisco, CA (US);  
**M. Evans Hankey**, San Francisco, CA (US);  
**Julian Hoenig**, San Francisco, CA (US);  
**Richard P. Howarth**, San Francisco, CA (US);  
**Jonathan P. Ive**, San Francisco, CA (US);  
**Duncan Robert Kerr**, San Francisco, CA (US);  
**Marc A. Newson**, London (GB);  
**Matthew Dean Rohrbach**, San Francisco, CA (US);  
**Peter Russell-Clarke**, San Francisco, CA (US);  
**Benjamin Andrew Shaffer**, San Jose, CA (US);  
**Mikael Silvanto**, San Francisco, CA (US);  
**Christopher J. Stringer**, Woodside, CA (US);  
**Eugene Antony Whang**, San Francisco, CA (US);  
**Rico Zörkendörfer**, San Francisco, CA (US)

(73) Assignee: **Apple Inc.**, Cupertino, CA (US)

(\*\*) Term: **15 Years**

(21) Appl. No.: **29/528,818**

(22) Filed: **Jun. 1, 2015**

**Related U.S. Application Data**

(63) Continuation of application No. 29/498,996, filed on Aug. 11, 2014, now Pat. No. Des. 731,346.

(51) **LOC (10) Cl.** ..... **11-01**

(52) **U.S. Cl.**  
USPC ..... **D11/3**

(58) **Field of Classification Search**

USPC ..... D11/1-25, 86, 93, 94; D10/30-39, 70, D10/46; 24/456, 574.1, 587.11, 587.12, 24/578.15; 600/301; 224/164, 175; 368/276, 281, 282, 285

CPC .... G04B 37/1486; G04B 37/16; G04B 37/18; A44C 5/14; A44C 5/0053; A44C 5/0069; A44C 5/0076; A44C 5/00; A44C 5/0007; A44C 5/0015; A44C 5/0023; A44C 5/003;

A44C 5/0061; A44C 5/12; A44C 5/18; A44C 5/185

See application file for complete search history.

(56) **References Cited**

U.S. PATENT DOCUMENTS

1,738,407 A 12/1929 Tost  
1,764,440 A 6/1930 Gammell et al.

(Continued)

FOREIGN PATENT DOCUMENTS

CN 2613171 Y 4/2004  
DE 10311560 A1 9/2004

(Continued)

OTHER PUBLICATIONS

CBWatches.com, "Braun Men's Prestige Digital Watch BN0106BKBTG With Black Plated Stainless Steel Case and Bracelet," <<http://cbwatches.com/shop/braun-mens-prestige-digital-watch-bn0106bkbtg-with-black-plated-stainless-steel-case-and-bracelet/>>, accessed Dec. 17, 2014.

(Continued)

*Primary Examiner* — Garth Rademaker

*Assistant Examiner* — Melanie Pellegrini

(74) *Attorney, Agent, or Firm* — Sterne, Kessler, Goldstein & Fox P.L.L.C.

(57) **CLAIM**

The ornamental design for a band, as shown and described.

**DESCRIPTION**

FIG. 1 is a bottom front perspective view of a band showing our new design;

FIG. 2 is a bottom rear perspective view thereof;

FIG. 3 is a front view thereof;

FIG. 4 is a rear view thereof;

FIG. 5 is a right side view thereof;

FIG. 6 is a left side view thereof;

FIG. 7 is a top view thereof;

FIG. 8 is a bottom view thereof;

FIG. 9 is a perspective view thereof showing the band in an environment in which it may be used;

FIG. 10 is FIG. 7 enlarged to show detail; and,

FIG. 11 is FIG. 8 enlarged to show detail.

The broken lines in the Figures show portions of the band and environment that form no part of the claimed design.

The dot-dash broken lines in the Figures show boundaries that form no part of the claimed design.

**1 Claim, 7 Drawing Sheets**

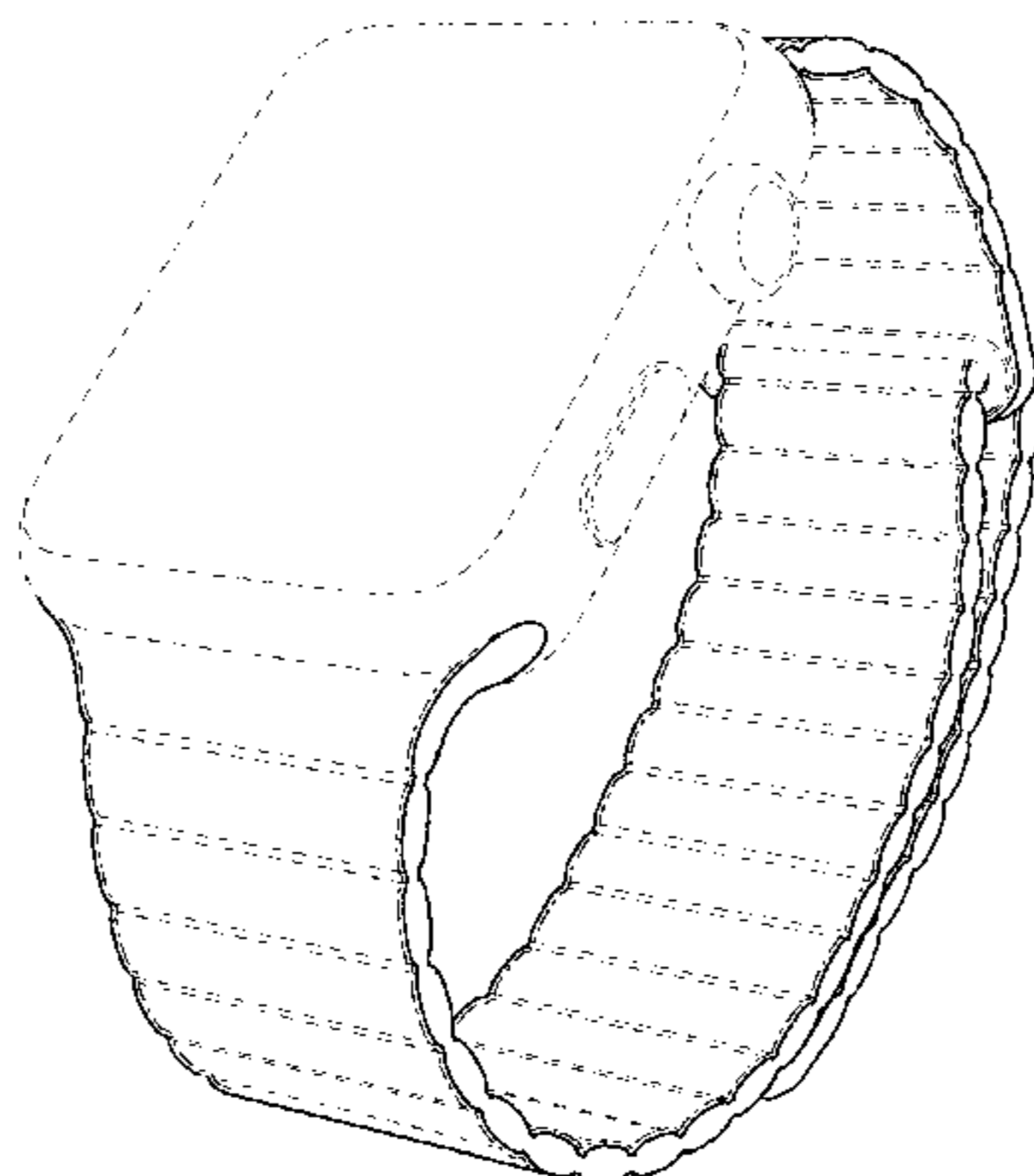

(56)

References Cited

FOREIGN PATENT DOCUMENTS

U.S. PATENT DOCUMENTS

1,786,943 A 12/1930 Gammell  
 D152,491 S 1/1949 Osier  
 3,030,686 A 4/1962 Burkhardt  
 3,372,500 A 3/1968 Claude  
 3,550,824 A \* 12/1970 Bohanski ..... 224/197  
 3,665,565 A 5/1972 Kruger  
 3,675,284 A 7/1972 Rieth  
 3,740,804 A \* 6/1973 Levinger ..... 24/265 WS  
 3,803,834 A 4/1974 Reese  
 D248,547 S \* 7/1978 Fernando ..... D10/32  
 D249,244 S 9/1978 Salter  
 D250,634 S 12/1978 Porsche  
 D256,568 S 8/1980 Young  
 4,266,400 A 5/1981 Tabata  
 D260,977 S \* 9/1981 Rimmler ..... D11/4  
 D269,254 S 6/1983 Kishimoto  
 D287,705 S 1/1987 Malamoud  
 D289,381 S \* 4/1987 Schneider ..... D10/32  
 D299,718 S 2/1989 Steer et al.  
 D305,422 S 1/1990 Steer et al.  
 D308,852 S \* 6/1990 Wakamatsu ..... D11/5  
 D310,334 S \* 9/1990 Jahan ..... D10/32  
 D331,020 S 11/1992 Ishii et al.  
 D333,626 S 3/1993 Chang  
 D349,864 S 8/1994 Dunlap et al.  
 5,363,351 A 11/1994 Carney  
 D355,375 S 2/1995 Bandy, II  
 D365,286 S 12/1995 Florian  
 D408,301 S 4/1999 Porsche et al.  
 D455,093 S 4/2002 Fitzgerald  
 D473,818 S 4/2003 Salvisberg  
 D488,392 S 4/2004 Tschumi  
 D494,098 S 8/2004 Cohen  
 6,782,690 B2 8/2004 Kwan  
 7,013,631 B2 3/2006 Carrola  
 D528,439 S 9/2006 Burton  
 D528,928 S 9/2006 Burton  
 7,107,790 B2 \* 9/2006 Frank ..... 63/21  
 D536,265 S 2/2007 Reynoso  
 D538,687 S 3/2007 Komulainen  
 D549,602 S 8/2007 Oberrieder et al.  
 D550,105 S 9/2007 Oberrieder et al.  
 D560,520 S 1/2008 Oberrieder et al.  
 D569,282 S 5/2008 Daniel  
 D573,905 S 7/2008 Poirier  
 D575,656 S \* 8/2008 Scholpp ..... D11/3  
 D581,811 S 12/2008 Messmer et al.  
 D588,472 S 3/2009 Messmer et al.  
 D610,476 S 2/2010 Daniel  
 D631,761 S 2/2011 Barbier  
 D645,360 S 9/2011 Kiser et al.  
 D670,583 S 11/2012 Shaanan  
 D672,667 S 12/2012 Mix  
 8,601,784 B2 12/2013 Kaltenrieder  
 D704,077 S 5/2014 Monachon  
 D724,469 S 3/2015 Akana et al.  
 D727,197 S 4/2015 Akana et al.  
 D727,198 S 4/2015 Akana et al.  
 D727,199 S 4/2015 Akana et al.  
 D727,787 S 4/2015 Akana et al.  
 D731,346 S \* 6/2015 Akana et al. .... D11/3  
 2005/0210857 A1 9/2005 Carrola  
 2014/0096345 A1 4/2014 Tschumi  
 2014/0098649 A1 4/2014 Tschumi

EP 2636328 A1 9/2013  
 FR 906187-001 2/1991  
 GB 618917 A 3/1949  
 GB 2047514 A 12/1980  
 GB 2082277 5/1984  
 GB 2033807 3/1994  
 JP D1130391 1/2002  
 JP D1194393 1/2004  
 JP D1329491 5/2008  
 JP D1337213 8/2008  
 JP D1348945 1/2009  
 JP D1350052 2/2009  
 JP D1465158 3/2013  
 KR 30-0476859 1/2008  
 KR 30-0476860 1/2008  
 WO WO-DM/024020-001 11/1992  
 WO WO-DM052310 6/2000  
 WO WO-DM/060838-003 9/2002  
 WO WO-2013182397 A1 12/2013

OTHER PUBLICATIONS

Haedges, "1 Set Silver End Cap Clasp—Findings Large Toggle Clasp End Caps Buckle Connector with Five Inside Loops for Jewelry Making 26mm," <<http://www.etsy.com/listing/101269004/1-set-silver-end-cap-clasp-findings?ref=market>>, Listed on Aug. 29, 2014, accessed Oct. 9, 2014.  
 Metal Watch Band Silver Tone Stainless Steel Simple Narrow Expansion Band with Expandable Ends 8-11MM, <<http://www.esslinger.com/11mm-silver-narrow-expansion-replacement-watch-band-for-women.aspx>>, accessed Dec. 5, 2014.  
 [Online] <http://cnet4.cbsistatic.com/hub/i/r/2014/09/09/1d101da2-7abd-40aa-b0c9-94e4f9b27b95/thumbnail/770x433/c2705e97ac76cc74f2c19abc83929de9/apple-event-apple-watch-5446.jpg>. Retrieved on Feb. 17, 2015.  
 U.S. Appl. No. 29/498,987, filed Aug. 11, 2014.  
 U.S. Appl. No. 29/499,052, filed Aug. 11, 2014.  
 U.S. Appl. No. 29/499,061, filed Aug. 11, 2014.  
 U.S. Appl. No. 29/499,067, filed Aug. 11, 2014.  
 U.S. Appl. No. 29/499,068, filed Aug. 11, 2014.  
 U.S. Appl. No. 29/499,069, filed Aug. 11, 2014.  
 U.S. Appl. No. 29/499,080, filed Aug. 11, 2014.  
 U.S. Appl. No. 29/499,081, filed Aug. 11, 2014.  
 U.S. Appl. No. 29/499,082, filed Aug. 11, 2014.  
 U.S. Appl. No. 29/499,088, filed Aug. 11, 2014.  
 U.S. Appl. No. 29/499,090, filed Aug. 11, 2014.  
 U.S. Appl. No. 29/499,091, filed Aug. 11, 2014.  
 U.S. Appl. No. 29/501,152, filed Sep. 2, 2014.  
 U.S. Appl. No. 29/501,624, filed Sep. 5, 2014.  
 U.S. Appl. No. 29/501,720, filed Sep. 8, 2014.  
 U.S. Appl. No. 29/501,722, filed Sep. 8, 2014.  
 U.S. Appl. No. 29/501,723, filed Sep. 8, 2014.  
 U.S. Appl. No. 29/501,733, filed Sep. 8, 2014.  
 U.S. Appl. No. 29/501,737, filed Sep. 8, 2014.  
 U.S. Appl. No. 29/501,746, filed Sep. 8, 2014.  
 U.S. Appl. No. 29/501,759, filed Sep. 8, 2014.  
 U.S. Appl. No. 29/501,760, filed Sep. 8, 2014.  
 U.S. Appl. No. 29/501,766, filed Sep. 8, 2014.  
 U.S. Appl. No. 29/501,772, filed Sep. 8, 2014.  
 JPO's Document No. HA23009178, Real Design No. 3, vol. 7, p. 11, Jan. 16, 2012, Ei Publishing Co., Ltd. (Japan).  
 JPOs Document No. HB26003714, Global Sources Gifts & Premiums No. 6, vol. 8, p. 17 Aug. 7, 2014, Trade Media Holdings Ltd. (Hong Kong).

\* cited by examiner

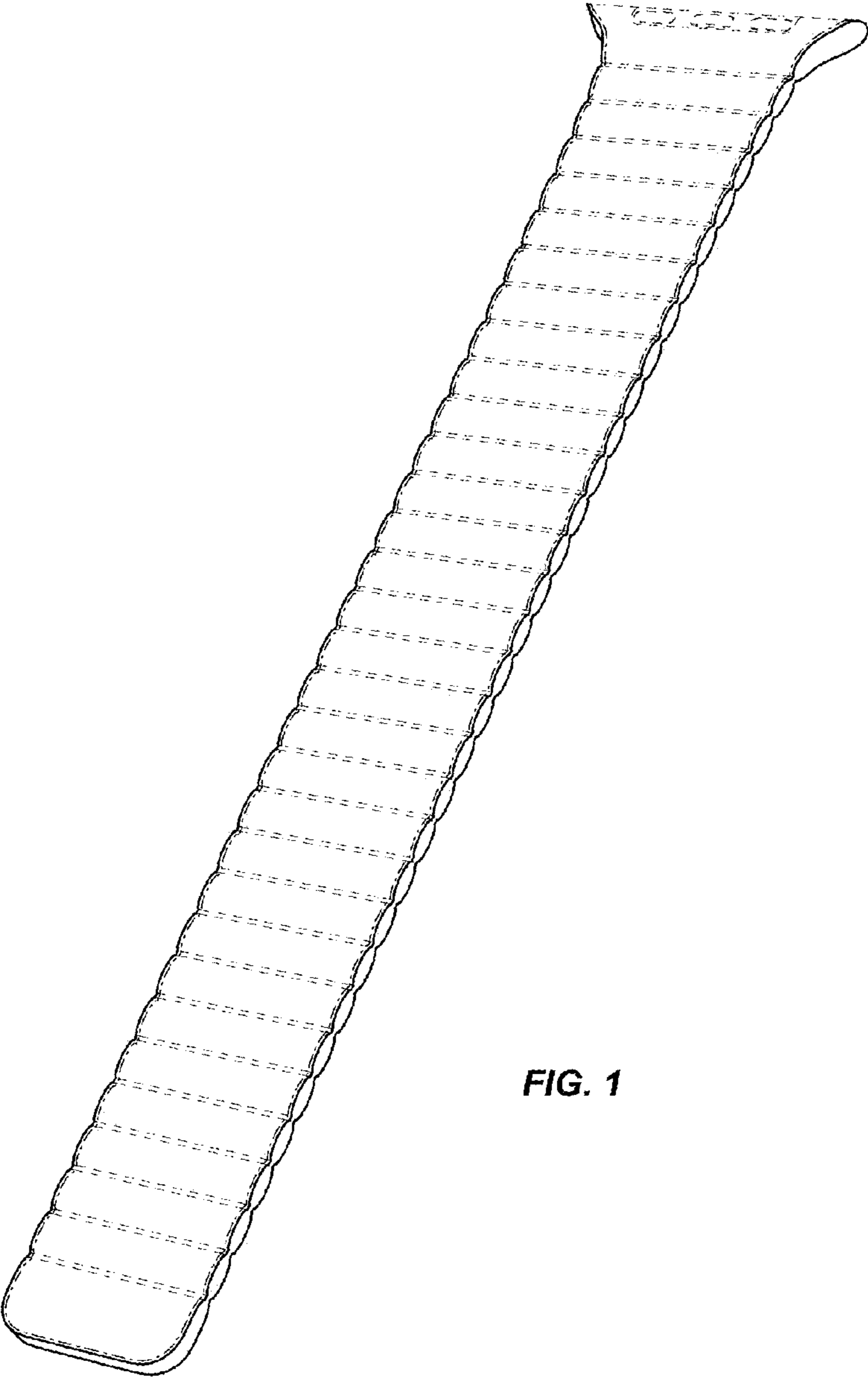
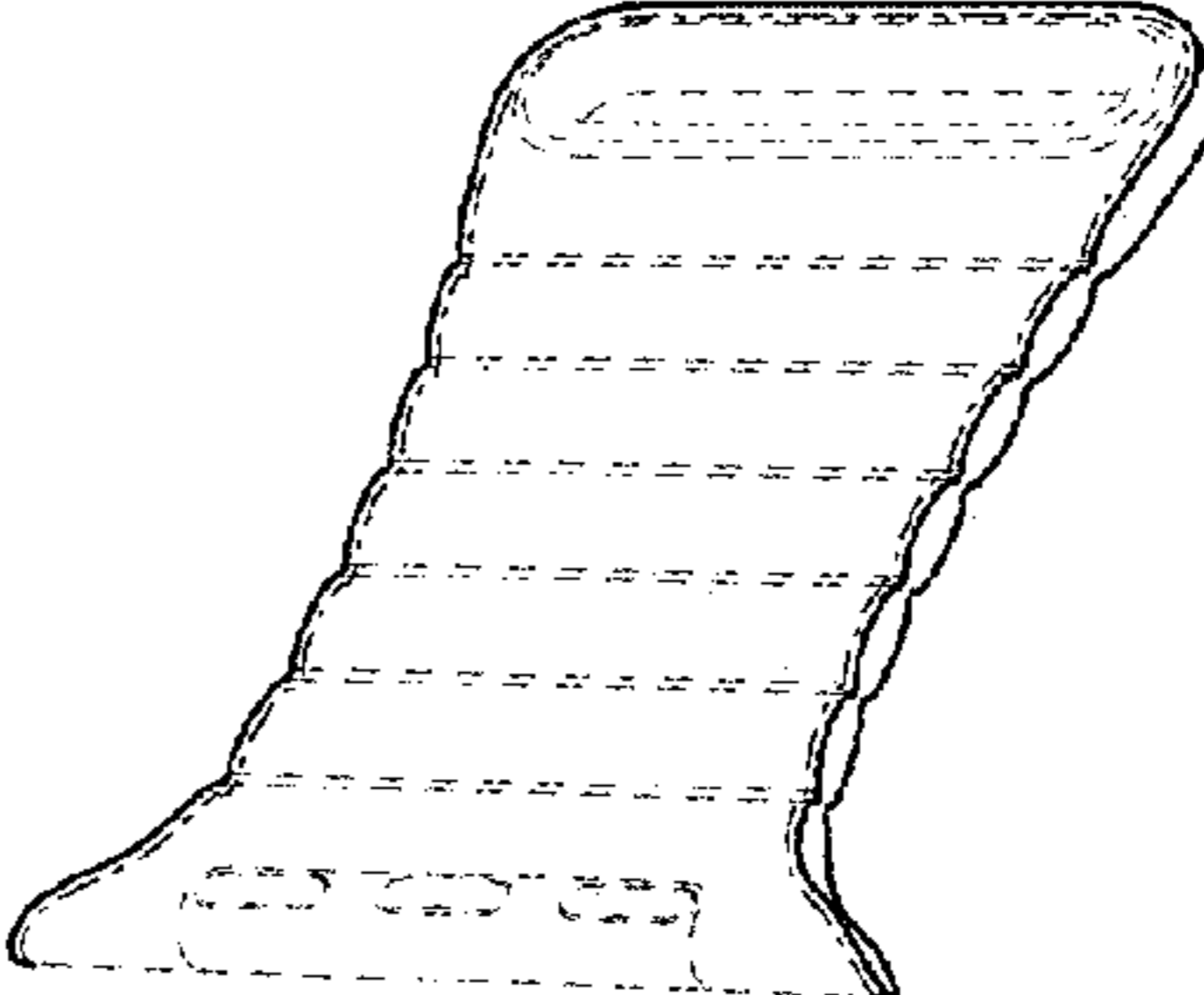

FIG. 1

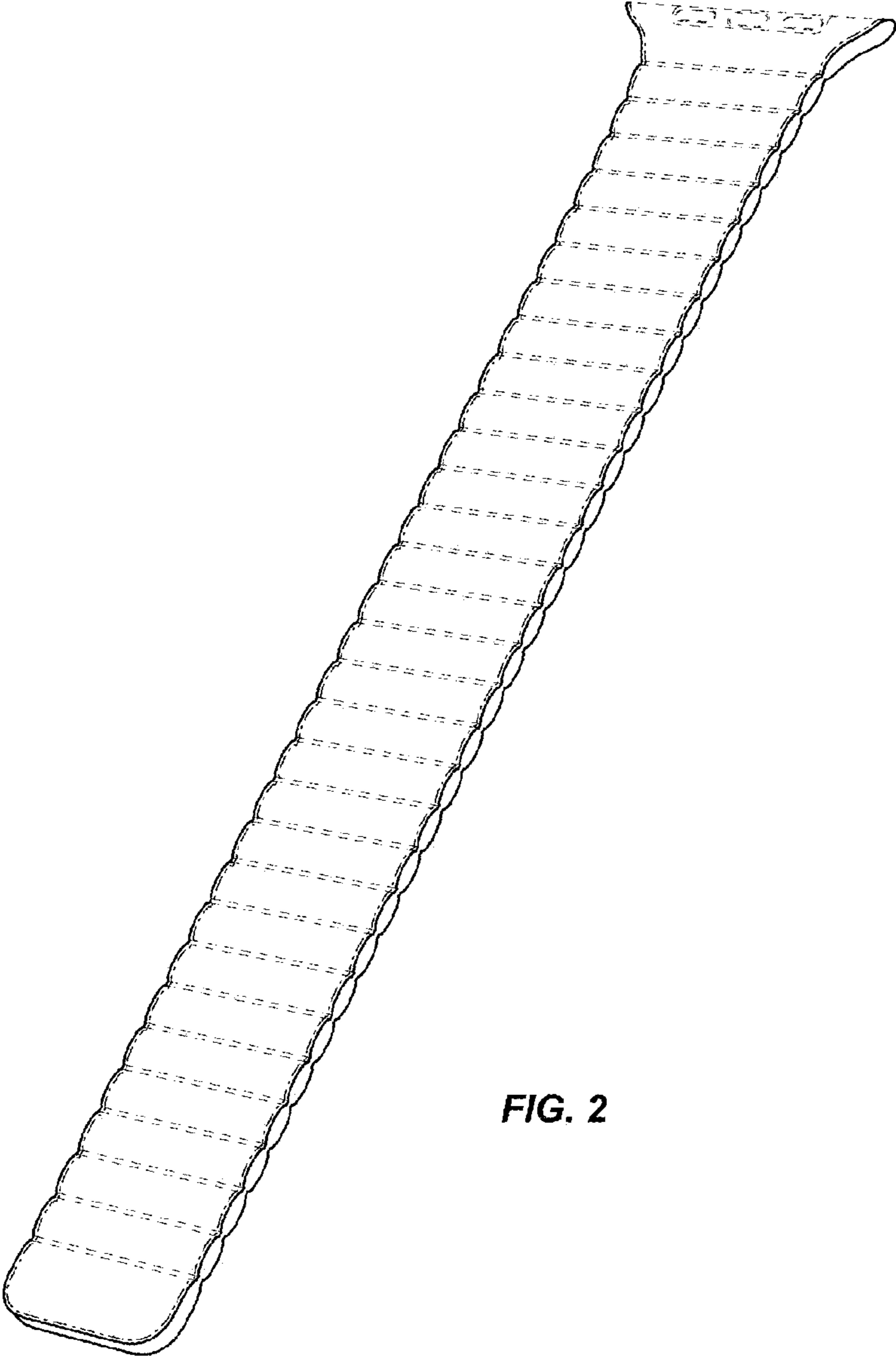
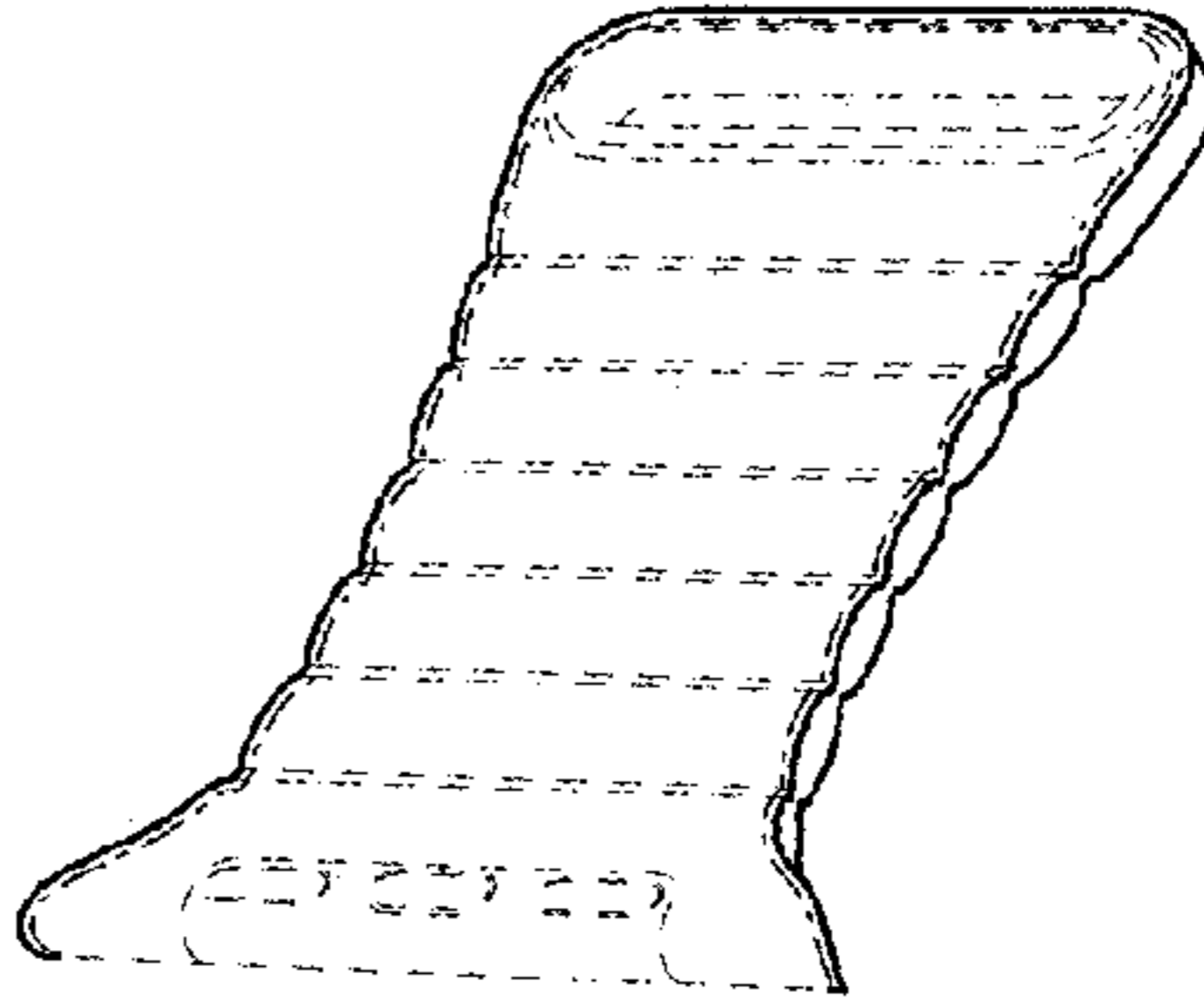

FIG. 2

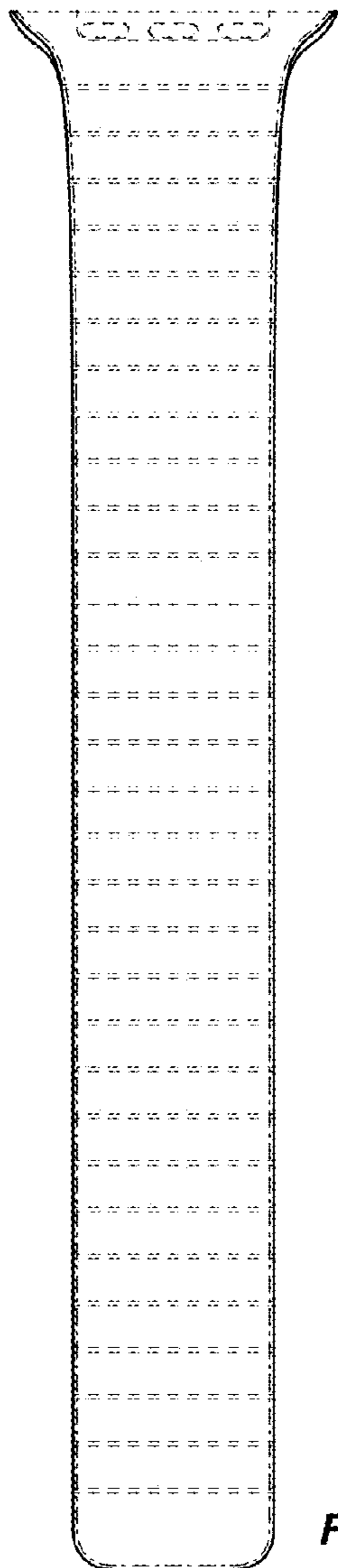
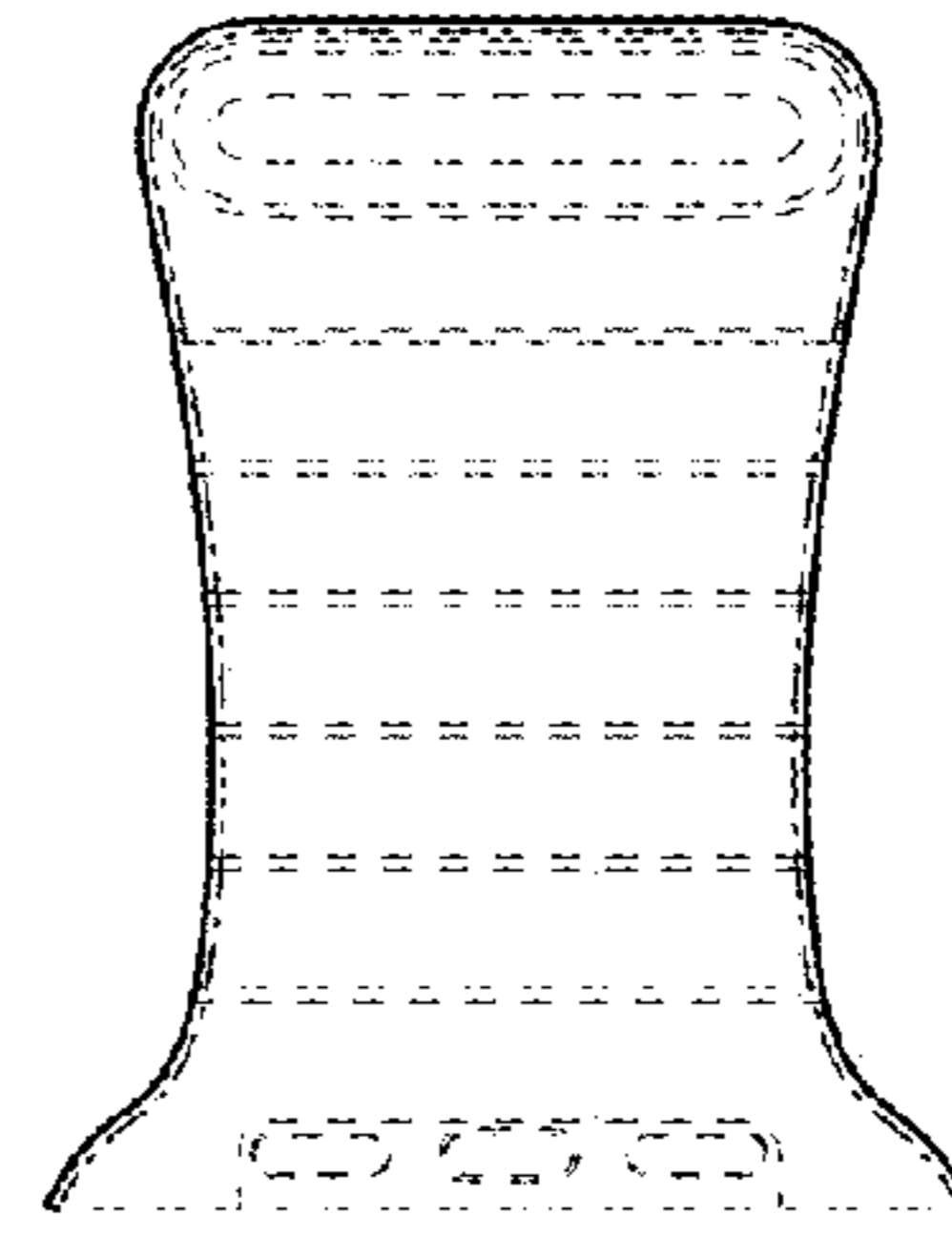
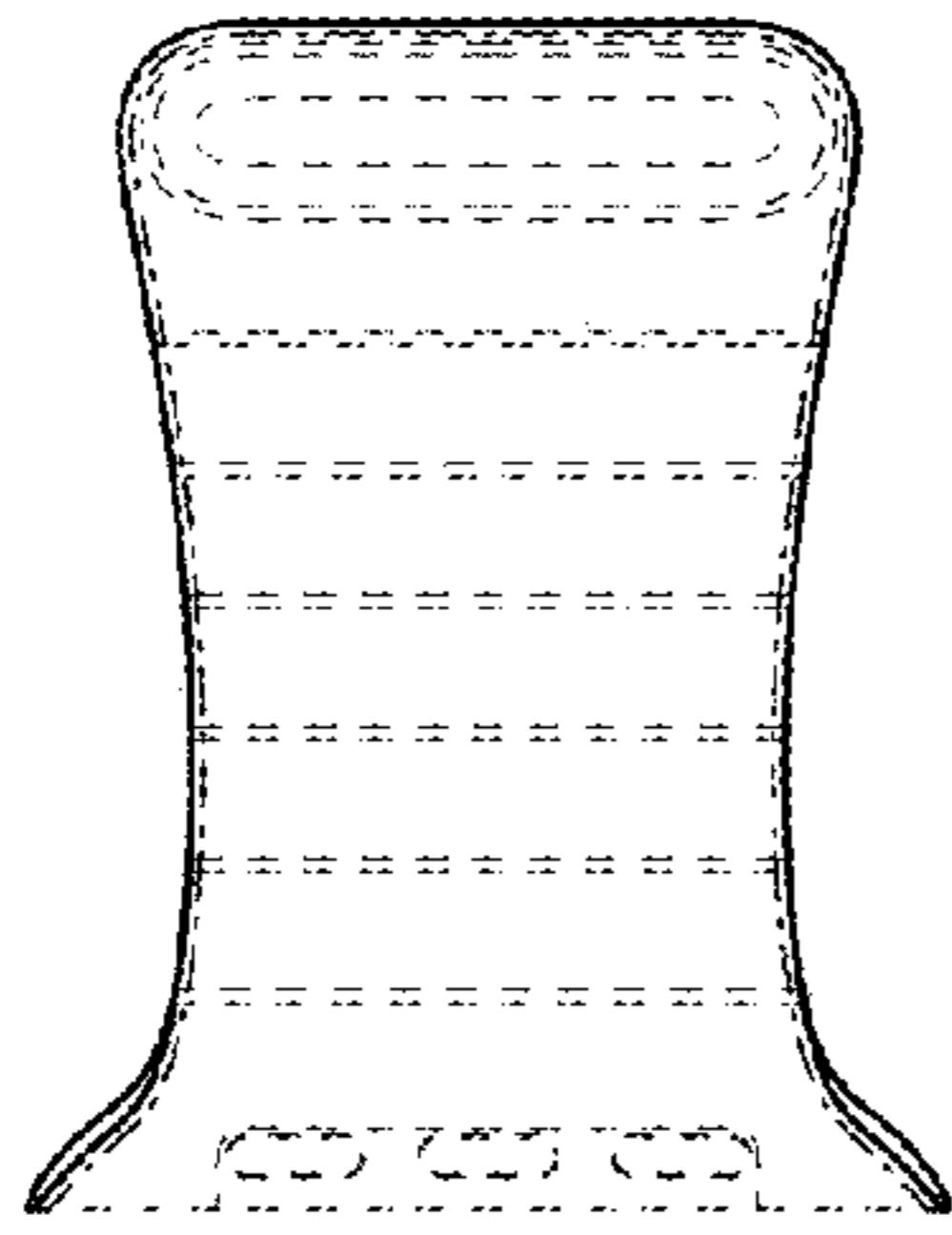

FIG. 3

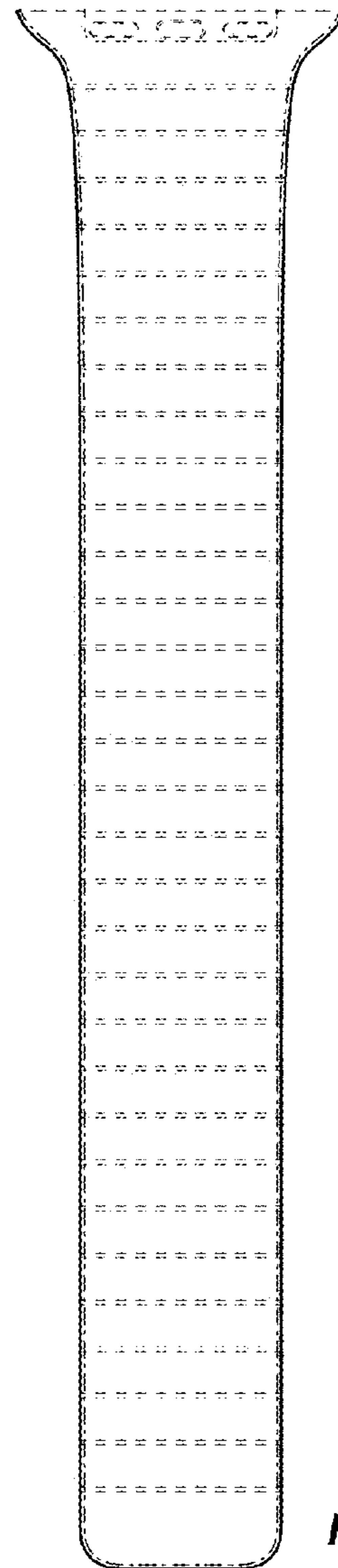
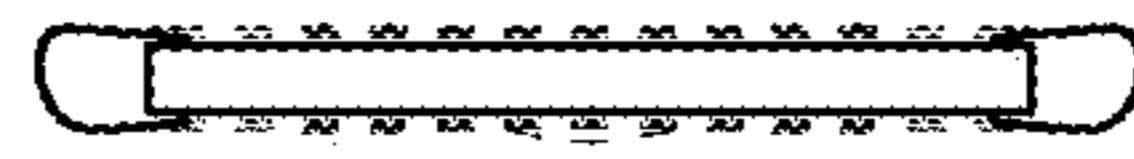

FIG. 4

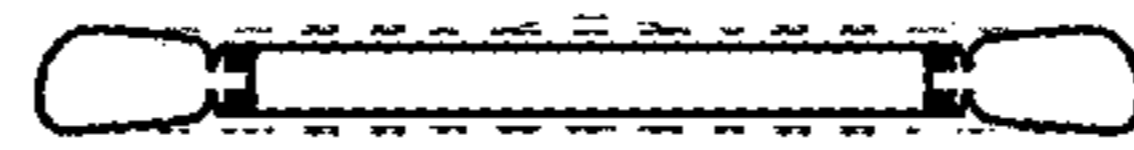

**FIG. 5**

**FIG. 6**



**FIG. 7**



**FIG. 8**

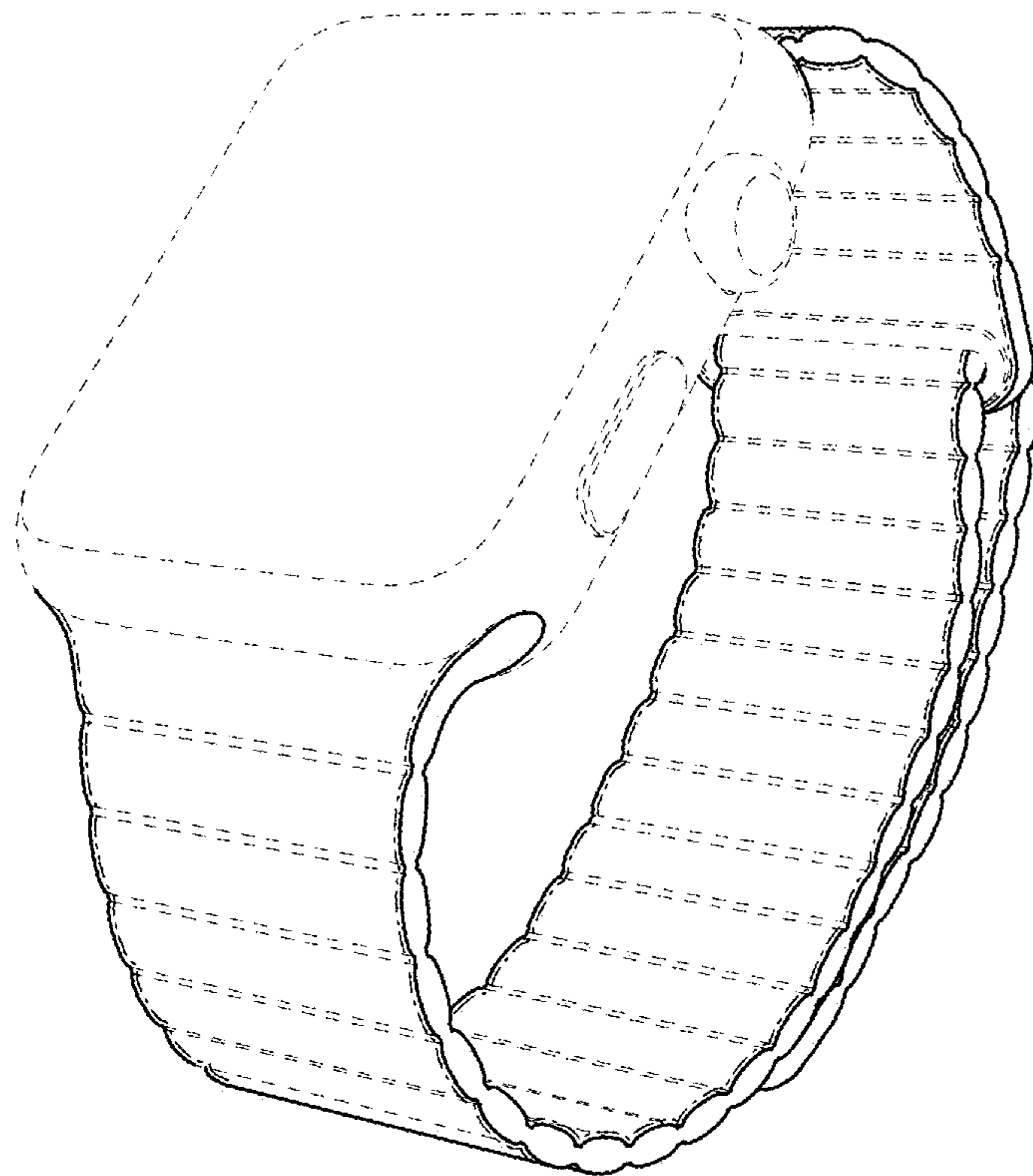
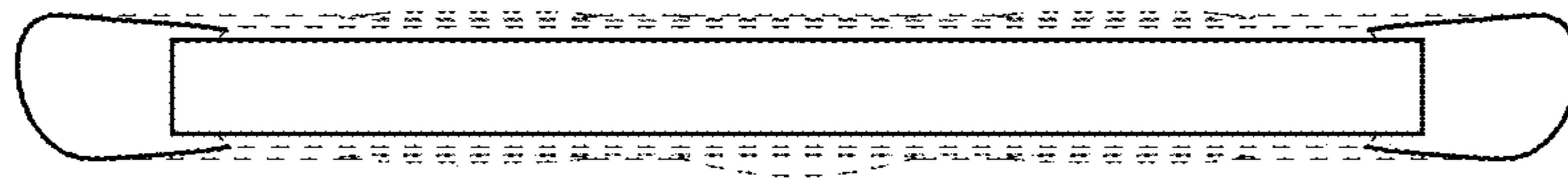
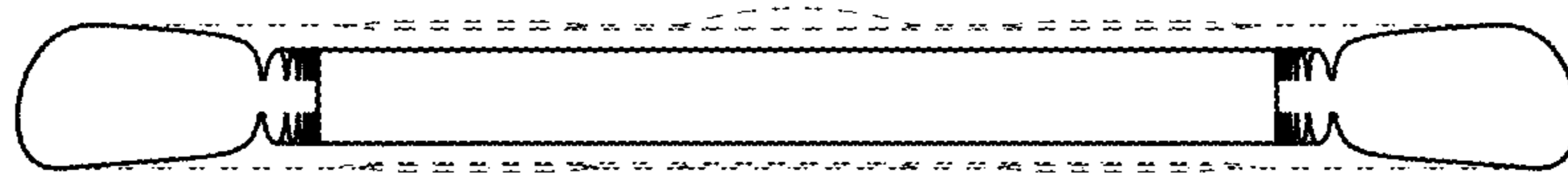

FIG. 9





**FIG. 10**



**FIG. 11**