



US00D757529S

(12) **United States Design Patent**
Chen

(10) **Patent No.:** **US D757,529 S**

(45) **Date of Patent:** **** May 31, 2016**

(54) **COVER FOR A SUCTION CUP**

(71) Applicant: **Fang Yin Chen**, Taichung (TW)

(72) Inventor: **Fang Yin Chen**, Taichung (TW)

(**) Term: **14 Years**

(21) Appl. No.: **29/517,767**

(22) Filed: **Feb. 17, 2015**

(51) **LOC (10) Cl.** **08-05**

(52) **U.S. Cl.**
USPC **D8/373**

(58) **Field of Classification Search**
USPC D8/375, 374, 381, 382, 380, 318, 373,
D8/377, 363, 358, 384, 376, 385, 388, 389,
D8/355, 394, 356, 396; D3/205; D6/553
CPC B25H 3/04; A47F 7/0021; A47B 81/007;
A47B 96/063
See application file for complete search history.

(56) **References Cited**

U.S. PATENT DOCUMENTS

D115,180 S *	6/1939	Holden	D6/317
D134,615 S *	12/1942	Pientkewic	D8/373
D216,458 S *	1/1970	Nestrock	D25/43
D322,554 S *	12/1991	Amussen	D8/373
D327,215 S *	6/1992	Pestone	D8/373
D332,390 S *	1/1993	Adams	D8/373

D499,635 S *	12/2004	Osborne	D8/373
D627,624 S *	11/2010	Brassard	D8/363
D646,558 S *	10/2011	Murray	D8/373
D668,531 S *	10/2012	Ito	D8/373
D706,610 S *	6/2014	Sakuma	D8/363
D715,132 S *	10/2014	McSweyn	D8/363
D730,723 S *	6/2015	McSweyn	D8/363

* cited by examiner

Primary Examiner — Robert M Spear

Assistant Examiner — Eliza Bennett-Hattan

(74) *Attorney, Agent, or Firm* — Raymond Y. Chan; David and Raymond Patent Firm

(57) **CLAIM**

The ornamental design for a cover for a suction cup, as shown and described.

DESCRIPTION

FIG. 1 is a perspective view of cover for a suction cup showing my new design.

FIG. 2 is a front view thereof.

FIG. 3 is a rear view thereof.

FIG. 4 is a right view thereof.

FIG. 5 is a left view thereof.

FIG. 6 is a top view thereof.

FIG. 7 is a bottom view thereof; and,

FIG. 8 is a perspective view showing the cover for a suction cup in a position of use.

The broken lines in the drawing depict environmental subject matter only and form no part of the claimed design.

1 Claim, 8 Drawing Sheets

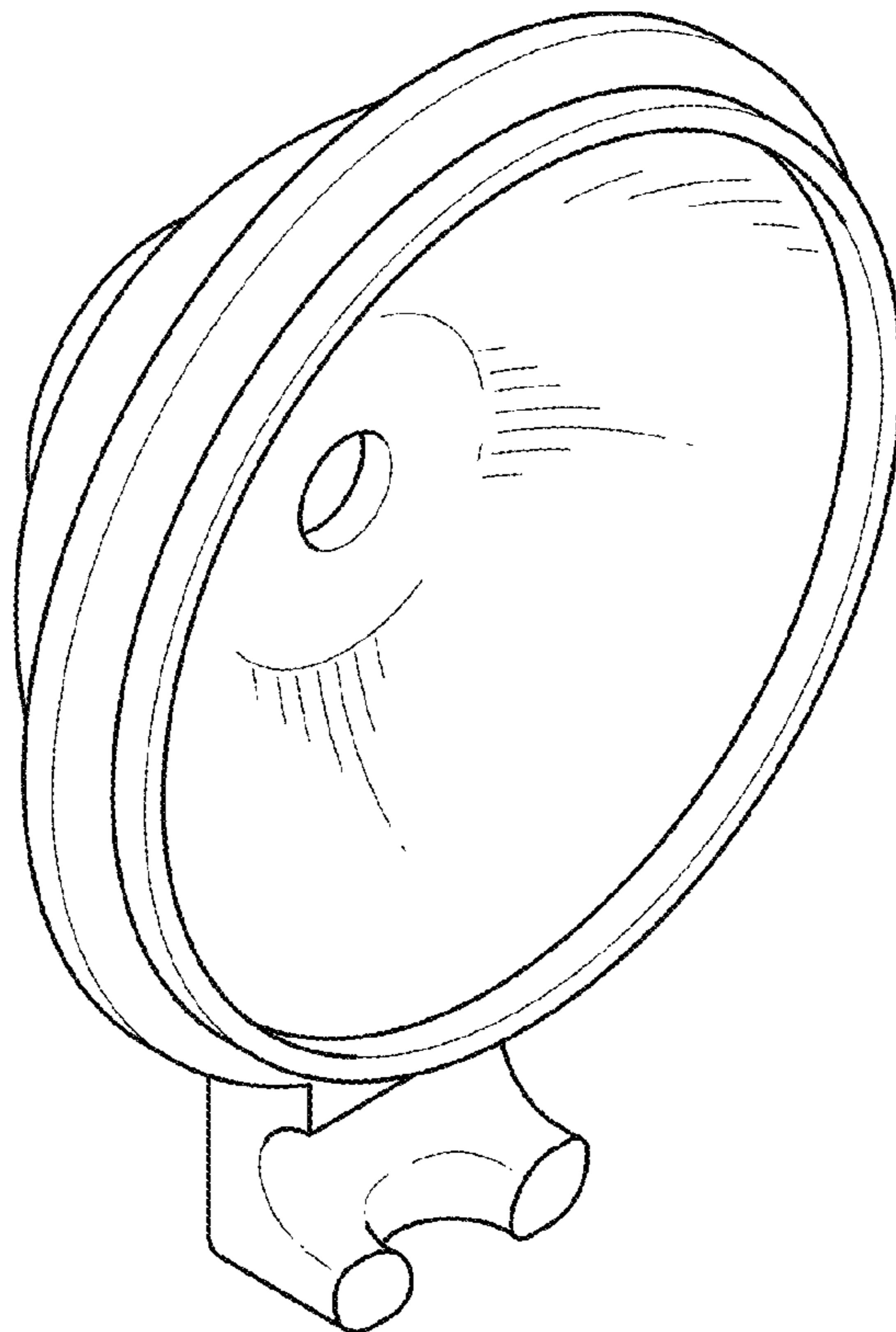

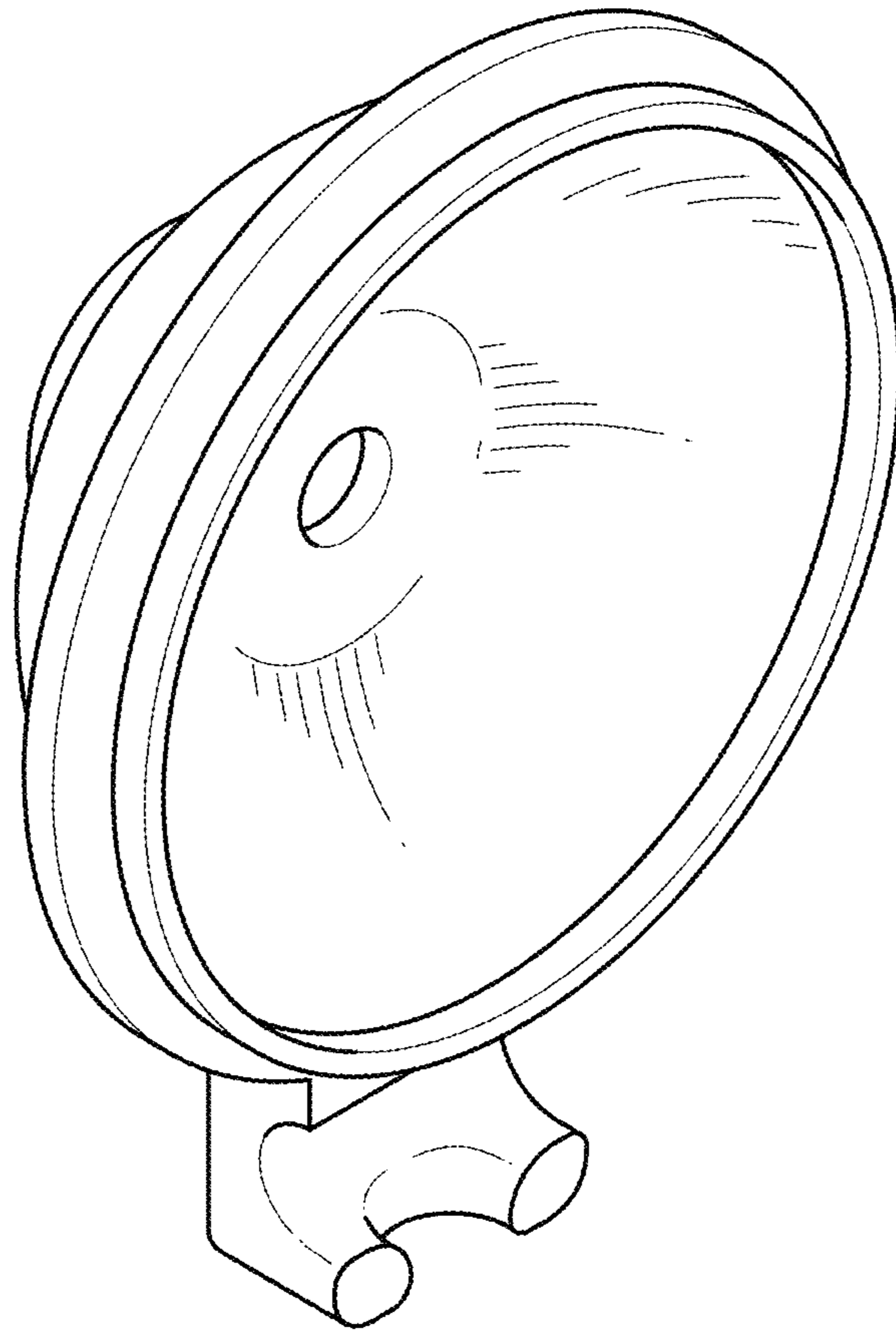

FIG. 1

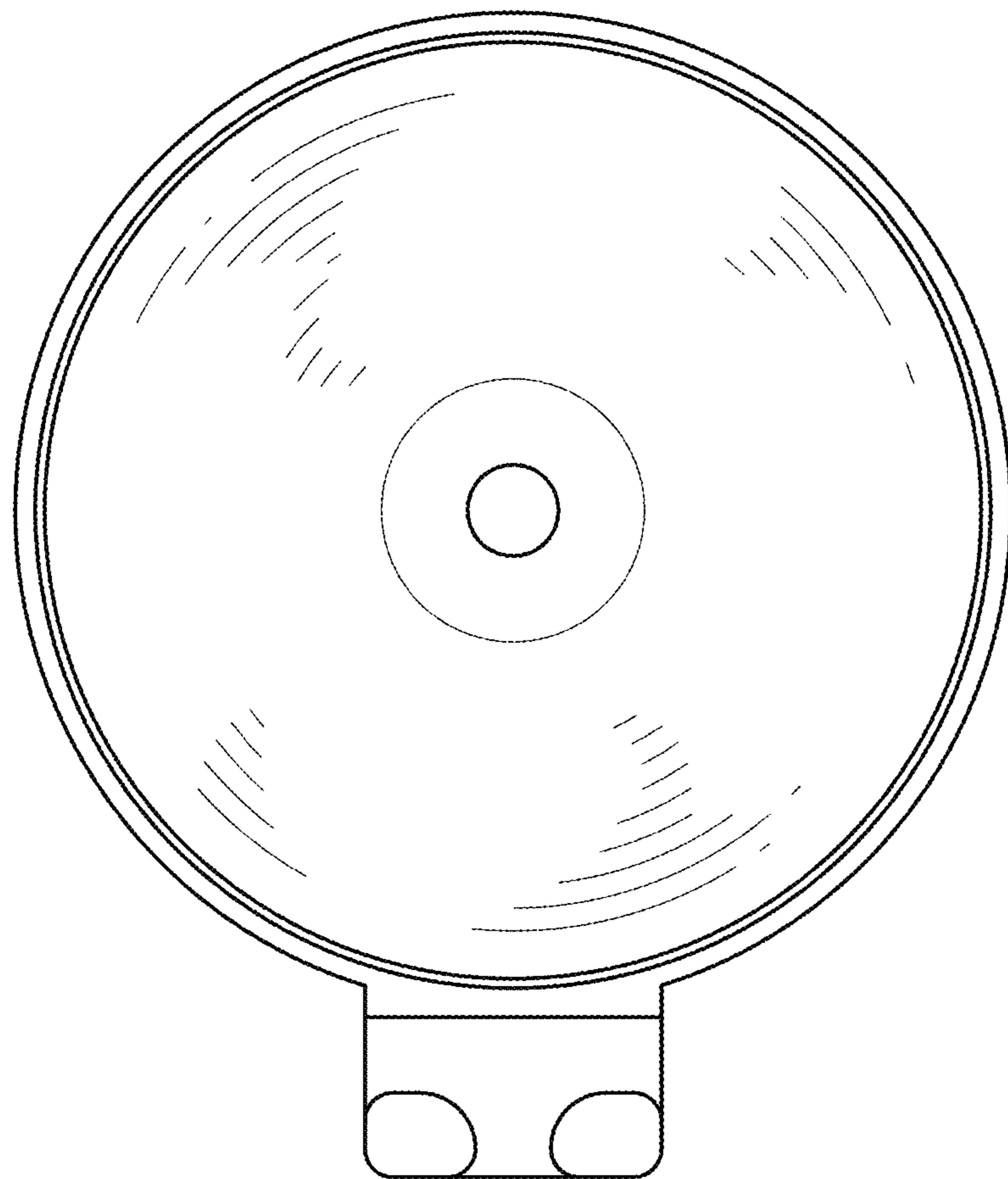

FIG. 2

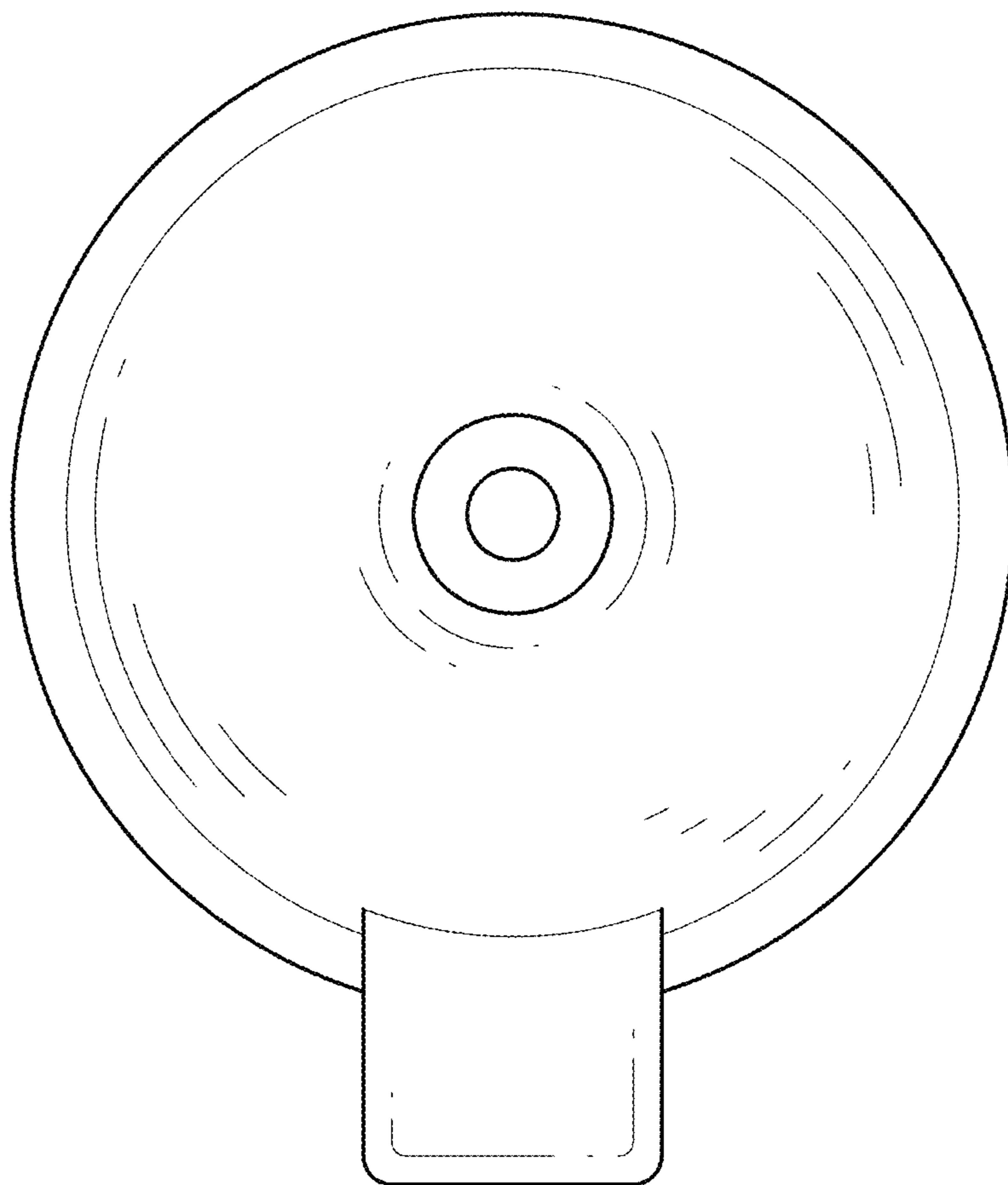

FIG. 3

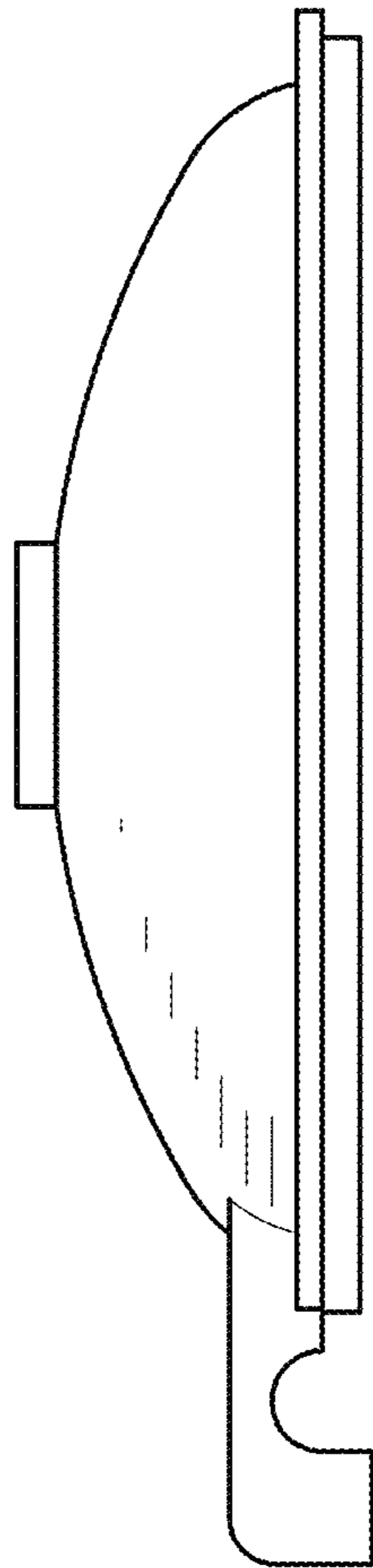

FIG. 4

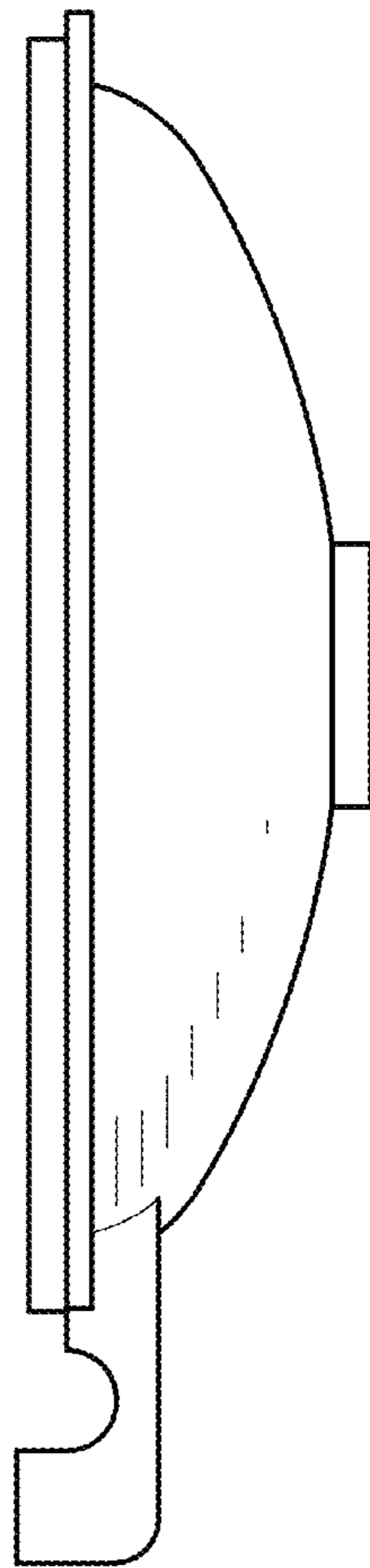

FIG. 5

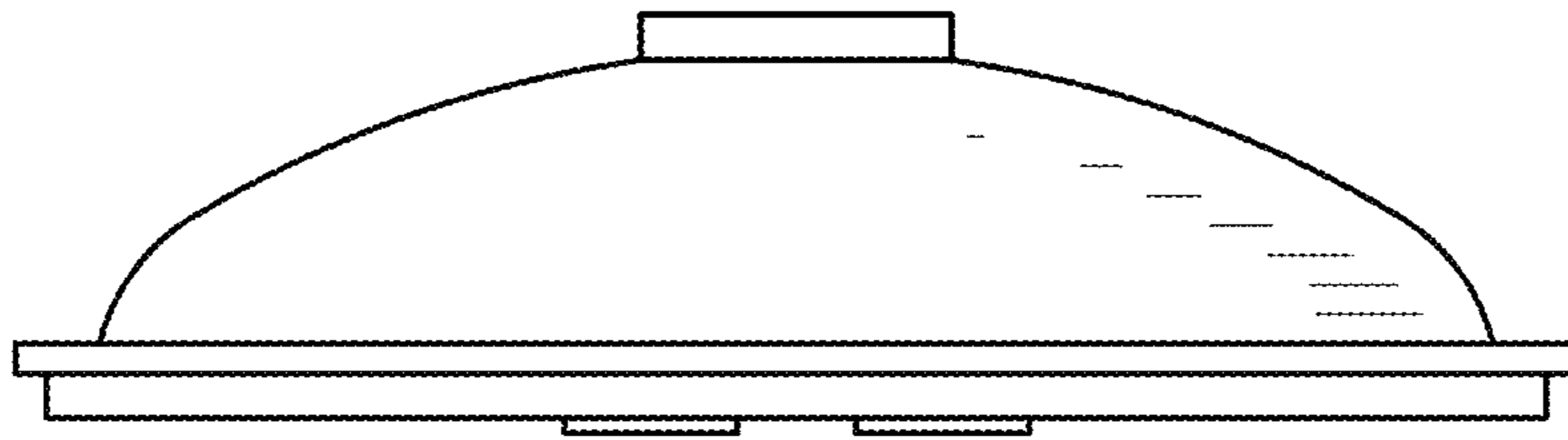

FIG. 6

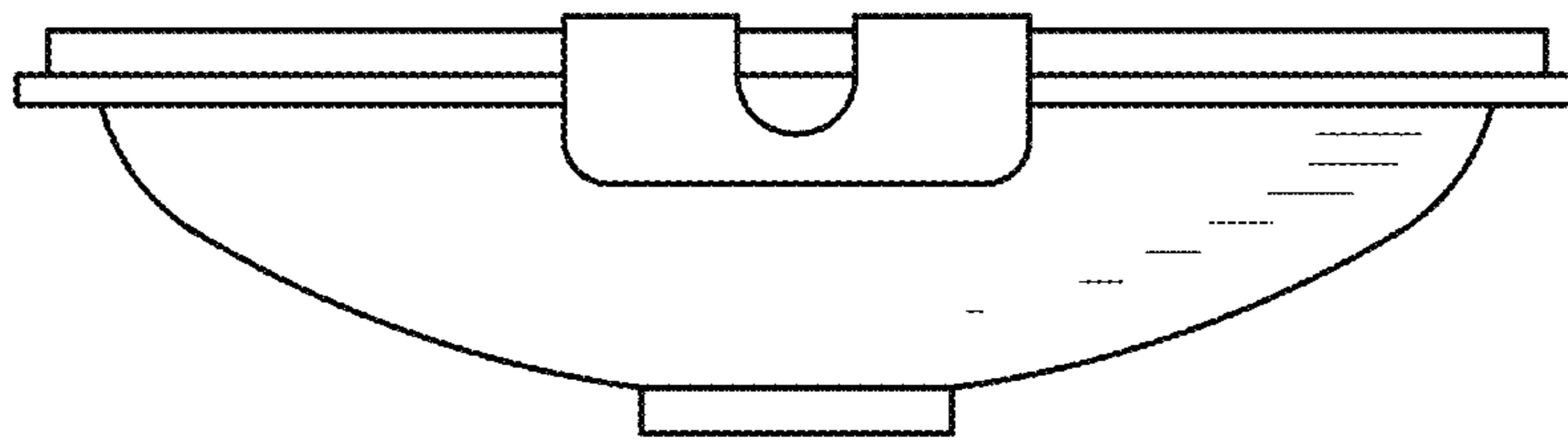

FIG. 7

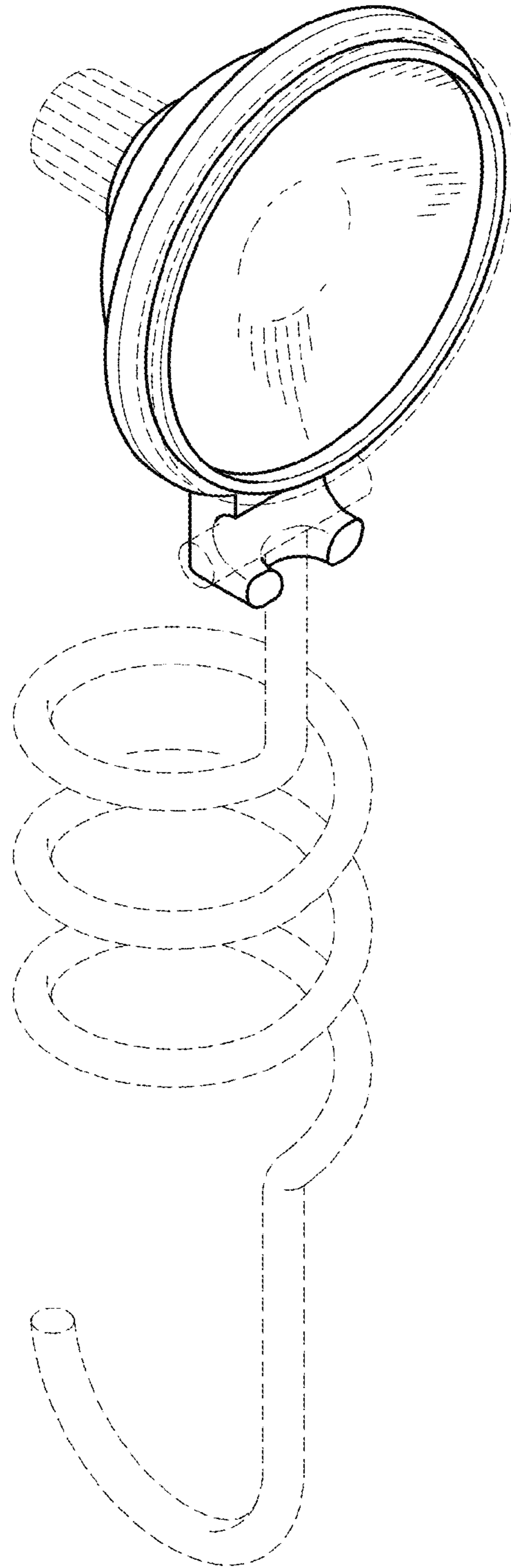

FIG. 8