



US00D757484S

(12) **United States Design Patent**
Brown et al.

(10) **Patent No.:** **US D757,484 S**
(45) **Date of Patent:** **** May 31, 2016**

(54) **BAKING PAN**

- (71) Applicant: **TARGET BRANDS, INC.**,
Minneapolis, MN (US)
- (72) Inventors: **Emily T. Brown**, Hudson, WI (US);
Patrick R. O’Connell, St. Louis Park,
MN (US); **Daniel Joseph Hoyord**,
Chaska, MN (US)
- (73) Assignee: **Target Brands, Inc.**, Minneapolis, MN
(US)
- (**) Term: **14 Years**

(21) Appl. No.: **29/495,152**

(22) Filed: **Jun. 27, 2014**

(51) **LOC (10) Cl.** **07-02**

(52) **U.S. Cl.**
USPC **D7/354**

(58) **Field of Classification Search**
USPC D6/601; D7/323, 354–361, 409, 543,
D7/545, 549, 550.1, 553.1–553.8,
D7/554.1–554.4, 555, 561, 584, 586, 688,
D7/698; D9/424, 425, 430–433, 455–456,
D9/737, 756–762; D24/230
CPC A21B 3/00; A21B 3/003; A21B 3/13;
A21B 3/15; A21B 3/134; A21B 5/00; A21B
5/02; A47J 36/022; A47J 36/025; A47J
36/027; A47J 37/00; A47J 37/04; A47J
37/067; A47J 43/28; A47J 43/284; B65D
1/22; B65D 1/24; B65D 1/34; B65D 1/36;
B65D 81/343; B65D 85/36; E04C 2/043
See application file for complete search history.

(56) **References Cited**

U.S. PATENT DOCUMENTS

D118,234 S	*	12/1939	Gundstrom	D7/409
D263,268 S	*	3/1982	Rein	D7/359
D287,104 S	*	12/1986	Holden	D9/425
D359,879 S	*	7/1995	Fielding	D7/354

(Continued)

OTHER PUBLICATIONS

Office Action from Canadian Patent Application No. 157,771, mailed
Dec. 23, 2014 (3 pages).

(Continued)

Primary Examiner — Ricky Pham
(74) *Attorney, Agent, or Firm* — Griffiths & Seaton PLLC;
JoAnn M. Seaton

(57) **CLAIM**

The ornamental design for baking pan, as shown and
described.

DESCRIPTION

FIG. 1 is a front, top perspective view of baking pan showing
a first embodiment of our new design;
FIG. 2 is a front view thereof;
FIG. 3 is a rear view thereof;
FIG. 4 is a right side view thereof;
FIG. 5 is a left side view thereof;
FIG. 6 is a top view thereof;
FIG. 7 is a bottom view thereof;
FIG. 8 is a front, top perspective view of baking pan showing
a second embodiment of our new design;
FIG. 9 is a front view thereof;
FIG. 10 is a rear view thereof;
FIG. 11 is a right side view thereof;
FIG. 12 is a left side view thereof;
FIG. 13 is a top view thereof; and,
FIG. 14 is a bottom view thereof.
The features shown in long dash-short dash bolded broken
lines indicate the bounds of the claimed design and otherwise
form no part of the claimed design.
Applicant reserves the right to amend the claimed invention
by showing in solid lines any and all features or portions
thereof originally shown in broken lines and/or by showing in
broken lines any and all features or portions thereof originally
shown in solid lines.

1 Claim, 10 Drawing Sheets

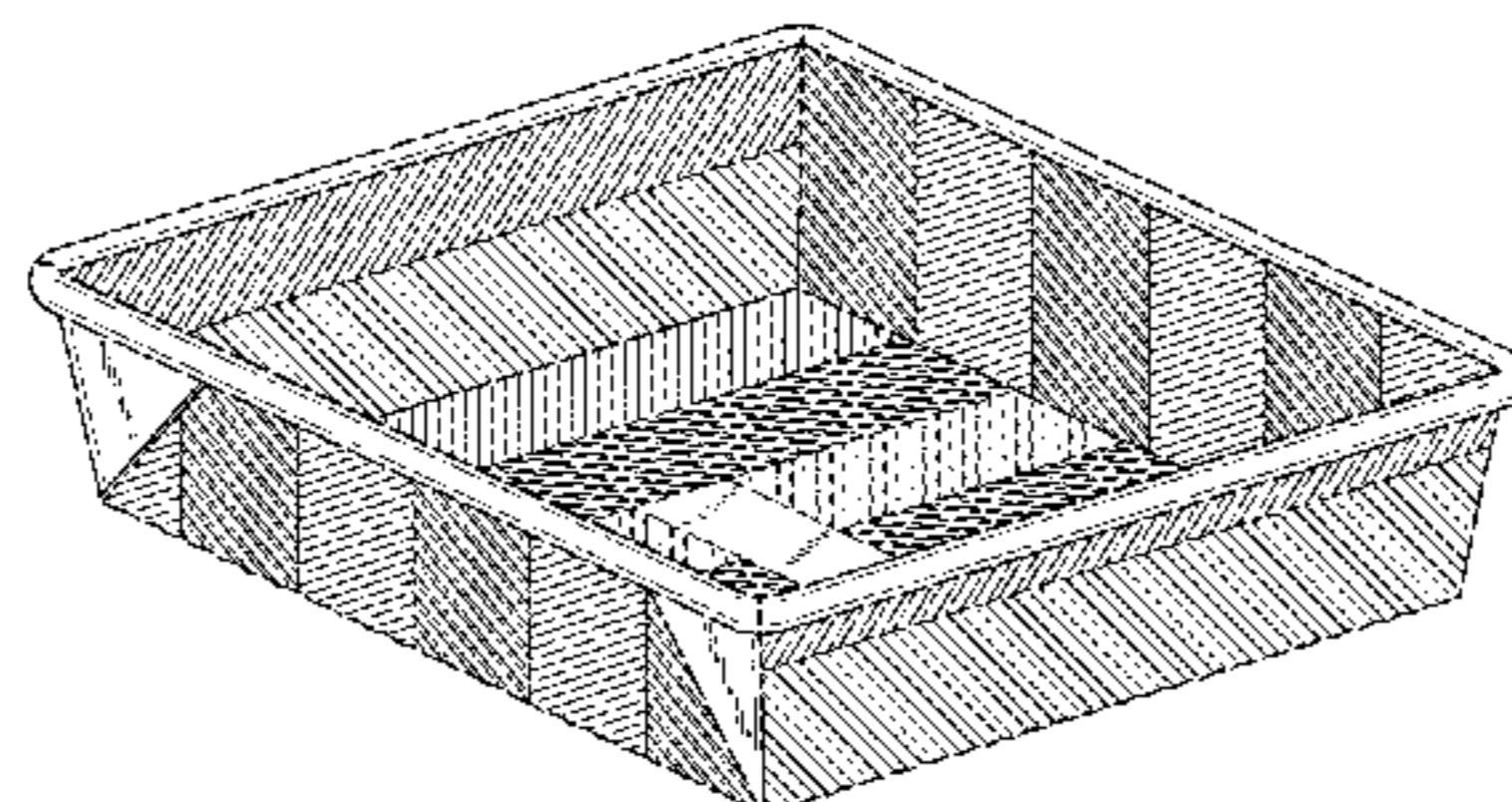
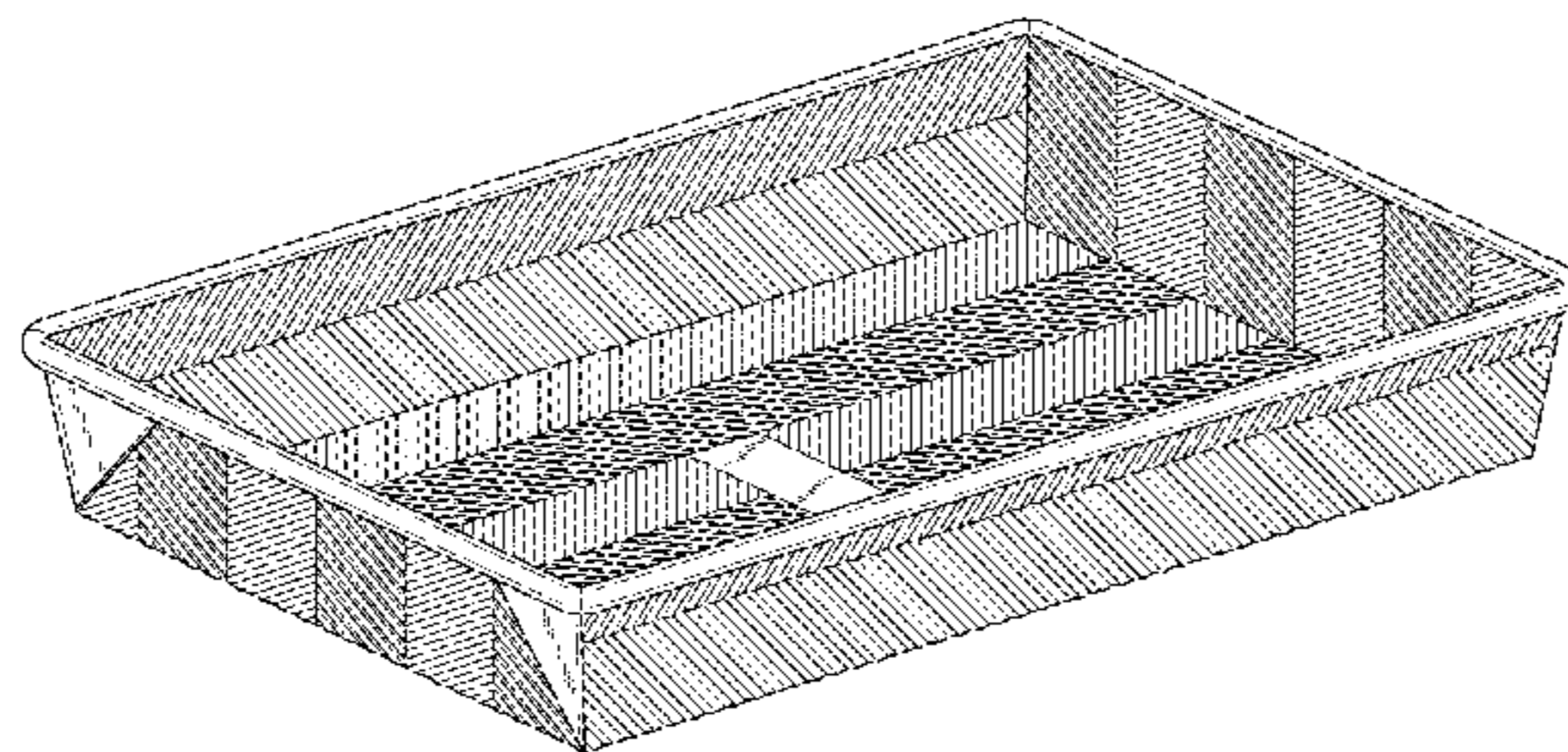

(56)

References Cited

U.S. PATENT DOCUMENTS

5,453,574	A *	9/1995	Zuran	A47J 37/067 126/25 R
D373,284	S	9/1996	Hirst		
D378,561	S *	3/1997	Ferris	D7/359
5,911,812	A *	6/1999	Stanek	A47J 37/067 126/25 R
5,921,173	A	7/1999	Grycan et al.		
D427,009	S *	6/2000	Iyengar	D7/354
D454,202	S *	3/2002	Pham	D24/216
D463,202	S *	9/2002	Smith	D7/359
D489,567	S *	5/2004	Groll	D7/354
D489,568	S *	5/2004	Groll	D7/354
D490,268	S *	5/2004	Groll	D7/354
D490,643	S *	6/2004	Groll	D7/354
D490,644	S *	6/2004	Groll	D7/354
7,325,325	B2 *	2/2008	Gleeson	E04C 2/043 33/1 B
D566,556	S *	4/2008	Baker	D9/456
D569,160	S *	5/2008	Mossbeck	D6/601
D593,805	S *	6/2009	Klimecki	D7/561
D604,556	S	11/2009	Zemel		
D622,094	S *	8/2010	Sarnoff	D7/354
D626,371	S *	11/2010	Sarnoff	D7/354
D628,434	S	12/2010	Sarnoff et al.		
D667,681	S	9/2012	Carsten		
D668,506	S *	10/2012	Zemel	D7/409
D682,634	S *	5/2013	Datavs	D7/698
D692,296	S *	10/2013	Cooper	D9/424
D697,757	S *	1/2014	Xin	D7/409
D723,324	S *	3/2015	Feriola	D7/354

OTHER PUBLICATIONS

Porter, Thyra, "Different Textures Surfacing from Bakeware Makers," HFN The Weekly Newspaper for the Home Furnishing Network, Feb. 10, 2003 (3 pages).

"Kaiser Bakeware Basic Tinplate 12-Inch Loaf Pan," printed from www.amazon.com/dp/B0009IK170/ref=asc_df_B0009IK170310352...0052238-20&creative=395261&creativeASIN=B0009IK170&linkCode=asn, publicly available at least as early as Jan. 21, 2008 (4 pages).

"USA Pans 6-Piece Bakeware Set," printed from www.amazon.com/USA-Pan-6-Piece-Bakeware-Set/dp/B008FK6G...%26camp%3D2025%26creative%3D165953%26creativeASIN%3DB008FK6GQY, publicly available at least as early as Sep. 30, 2012 (6 pages).

"Williams-Sonoma Goldtouch Nonstick Half Sheet Pan," printed from www.williams-sonoma.com/products/usa-pan-goldtouch-nonstick-half-sheet-pan/?cm_src=AutoRel, publicly available at least as early as Dec. 15, 2013 (3 pages).

"Bake King Metal Bake Pan Bread Pan Waffle Texture Vintage Kitchen Bakeware USA," circa 1950, printed from www.etsy.com/uk/listing/183506209/bake-king-metal-bake-pan-bread-pan?ref=market, publicly available at least as early as Apr. 25, 2014 (2 pages).

"Vintage Ovenex Starburst Embossed Roasting Pan Textured Tin Metal Baking Cake Pan Bright Metal Bakeware Ekco Vintage Baking Tray Rectangular," circa 1940, printed from www.etsy.com/listing/186025048/vintage-ovenex-starburst-embossed?ref=related-0, publicly available at least as early as Apr. 25, 2014 (2 pages).

"Vintage Waffle Textured Baking Pan Tin Tray Shallow Metal Roasting Pan Antique Bakeware Oven Ware Pressed Embossed Aged Metal Patina Willow," circa 1950, printed from www.etsy.com/listing/173830260/vintage-waffle-textured-baking-pan-tin?ref=market, publicly available at least as early as Apr. 25, 2014 (2 pages).

"USA Pan Pro Line Nonstick Baking Sheet," printed from www.crateandbarrel.com/usa-pan-pro-line-nonstick-baking-sheet/s677178, publicly available at least as early as Apr. 28, 2014 (2 pages).

"USA Pan Pro Line Nonstick Rectangular Cake Pan," printed from www.houzz.com/photos/4805926/USA-Pan-Pro-Line-Nonstick-Rectangular-Cake-Pan-contemporary-cake-pans-, publicly available at least as early as Apr. 28, 2014 (1 page).

"USA Pan Pro Line Nonstick Round Cake Pan," printed from www.houzz.com/photos/790287/USA-Pan-Pro-Line-Nonstick-Round-Cake-Pan-modern-cake-pans-, publicly available at least as early as Apr. 28, 2014 (1 page).

"Vintage Folded Metal Center Stamped Ovenex Perfect Bakeware Mini Loaf Pan," printed from www.ebay.com/itm/VINTAGE-Folded-metal-Center-stamped-Ovenex-perfect-bakeware-mini-loaf-pan, publicly available at least as early as Apr. 28, 2014 (4 pages).

"Vintage Ovenex Starburst Metal Baking Pan," printed from www.etsy.com/listing/168697882/vintage-ovenex-starburst-metal-baking-pan, publicly available at least as early as Apr. 28, 2014 (2 pages).

"Cooks Choice Bakeware Extra Large Oven Tray," printed from www.pinterest.com/pin/326018460494751435/, publicly available at least as early as Apr. 25, 2014 (1 page).

"Vintage Textured Tin Metal Baking Cake Pan Bakerex Crownware Embossed Radiant Crowns Aged Metal Bakeware Ovenware Vintage Baking Tray," circa 1940, printed from www.etsy.com/listing/179877916/bakerex-crownware-pan-vintag...pan&ga_original_query=2&ga_search_type=vintage&ga_view_type=gallery, publicly available at least as early as Apr. 28, 2014 (2 pages).

* cited by examiner

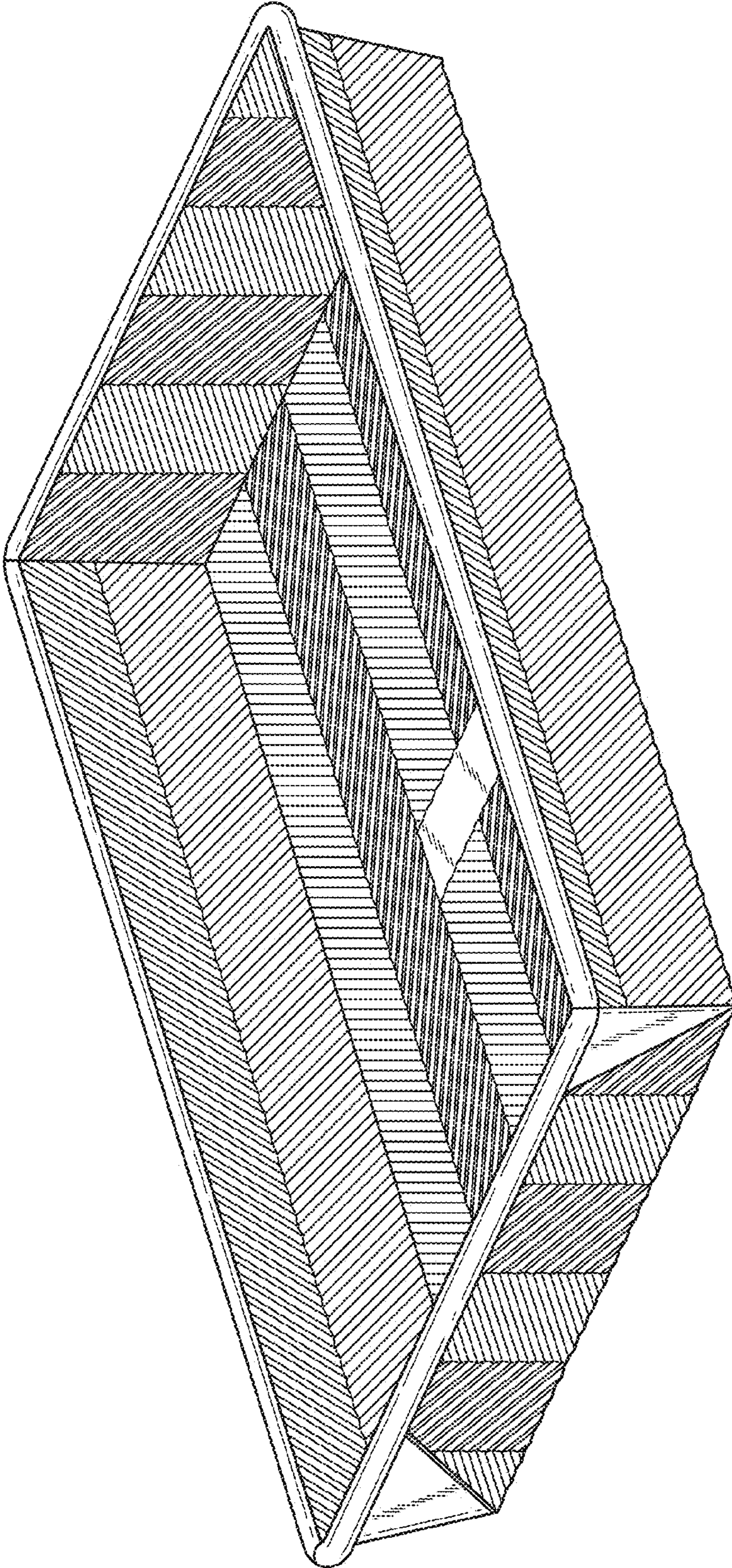

FIG. 1

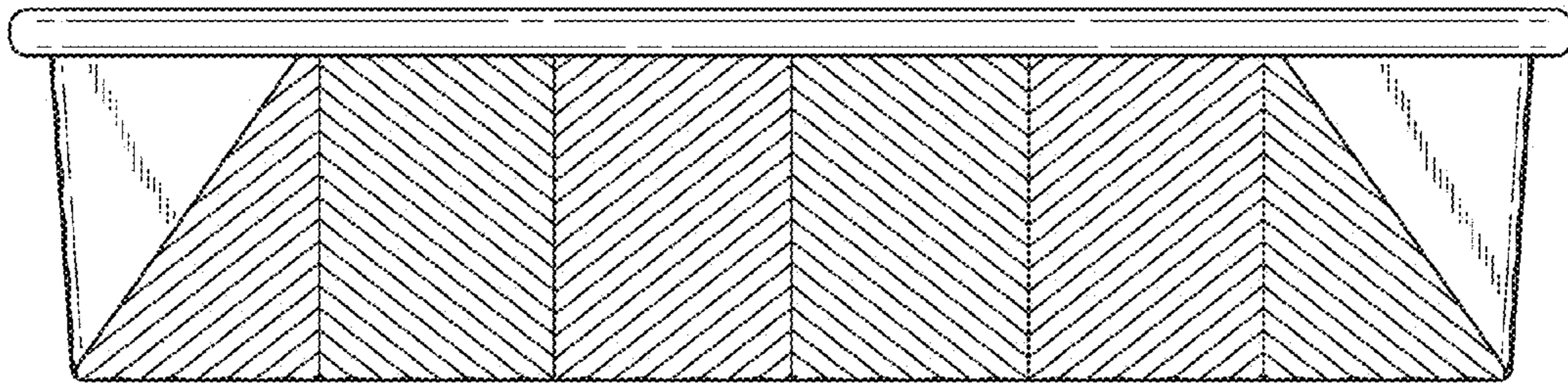

FIG. 2

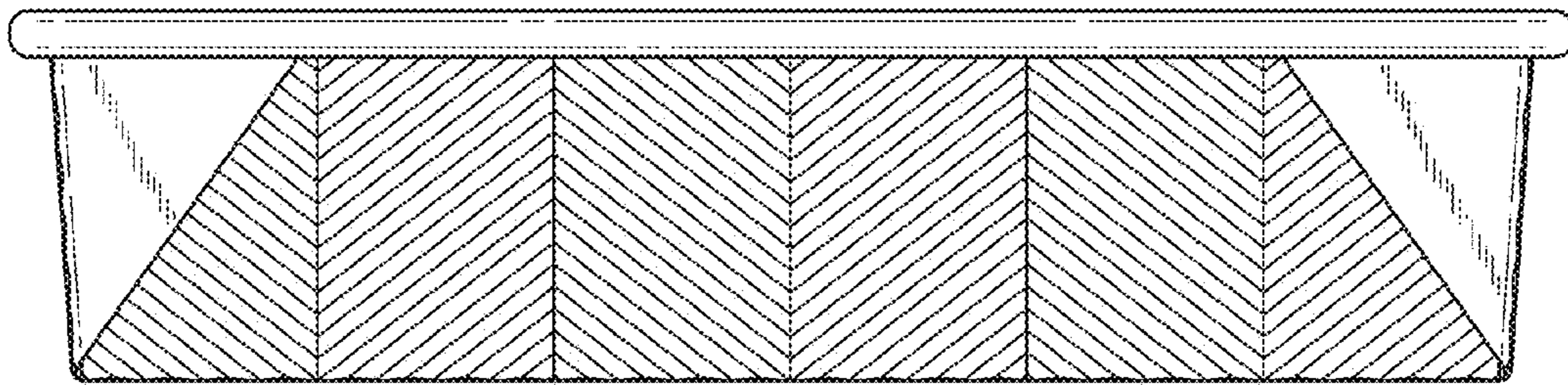

FIG. 3

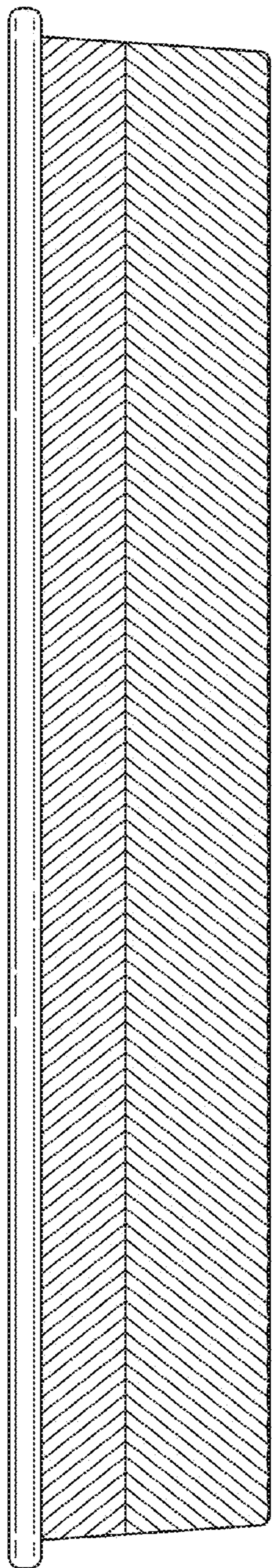

FIG. 4

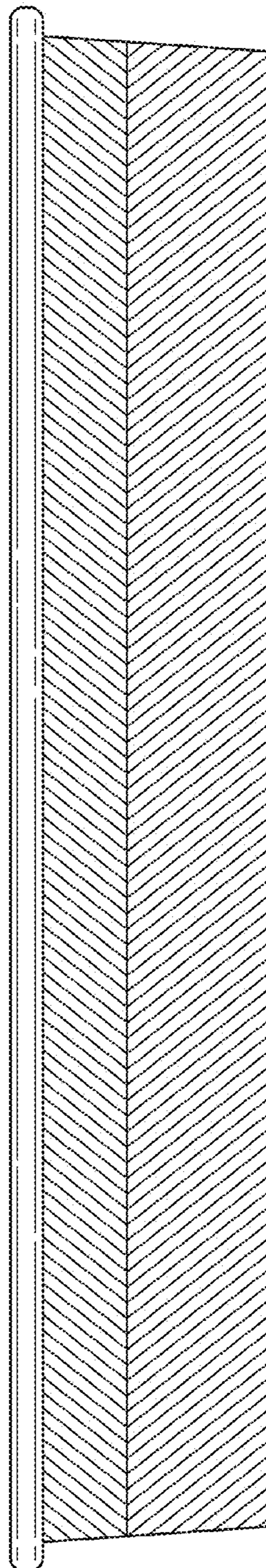

FIG. 5

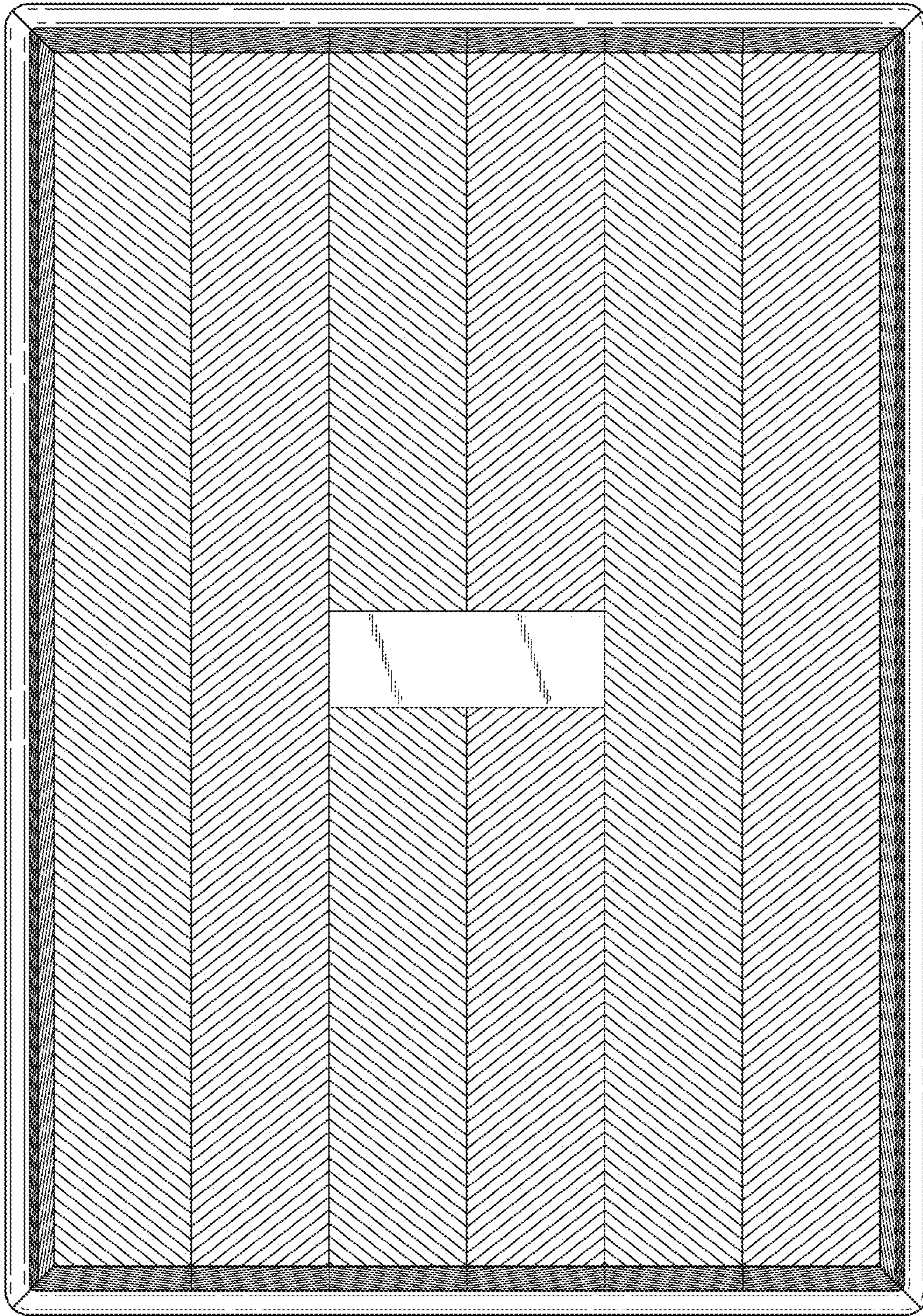

FIG. 6

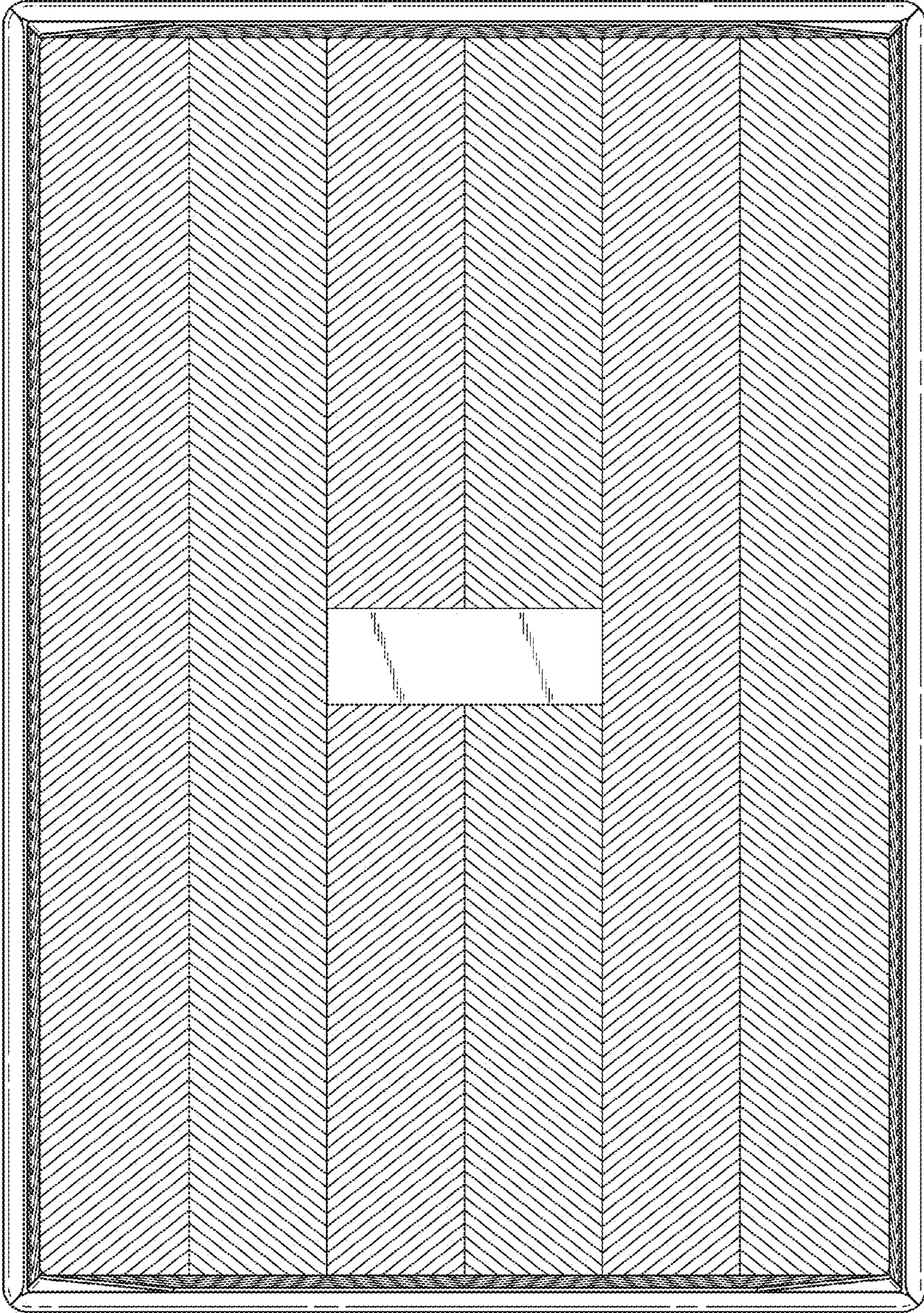

FIG. 7

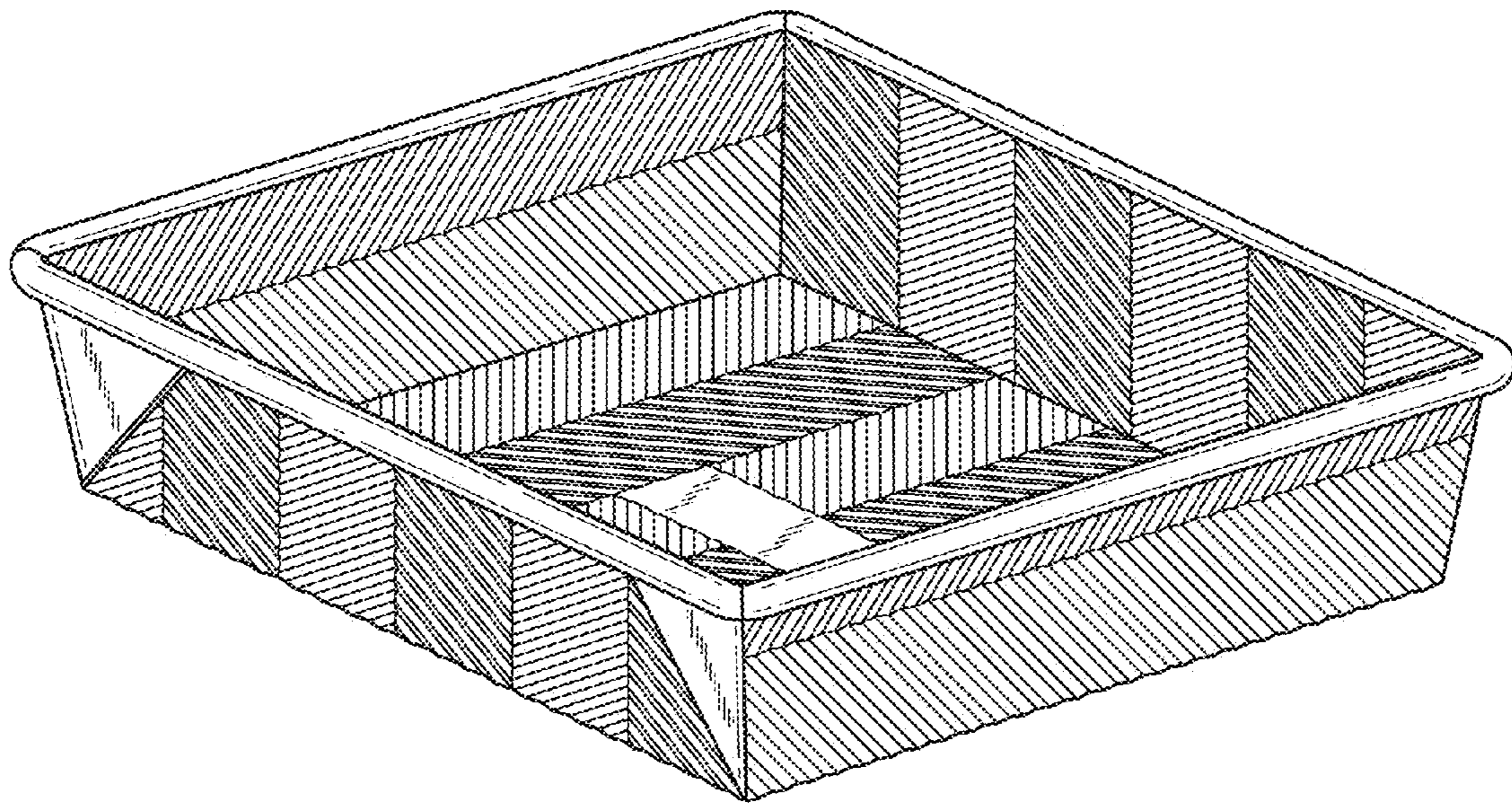

FIG. 8

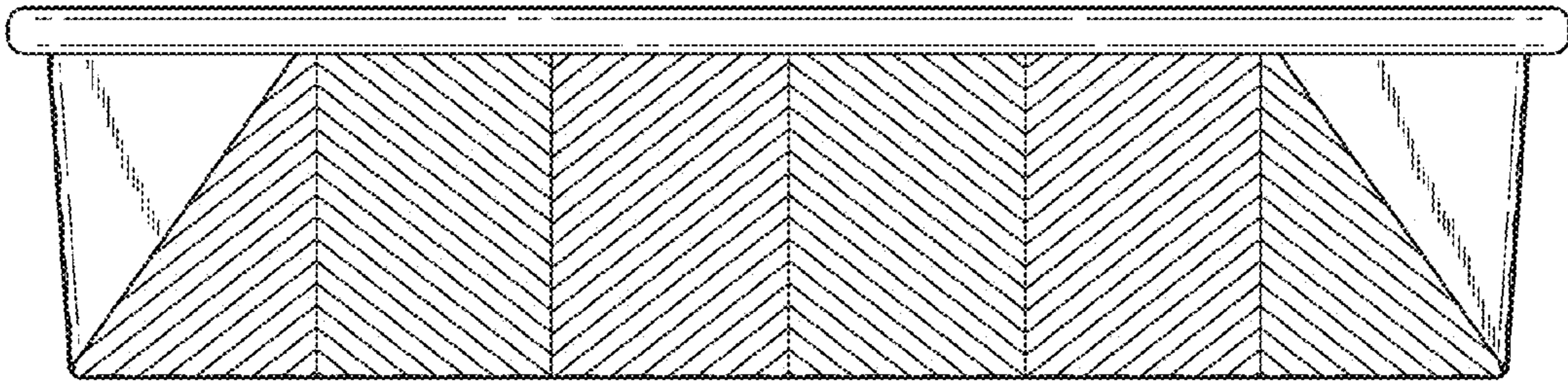

FIG. 9

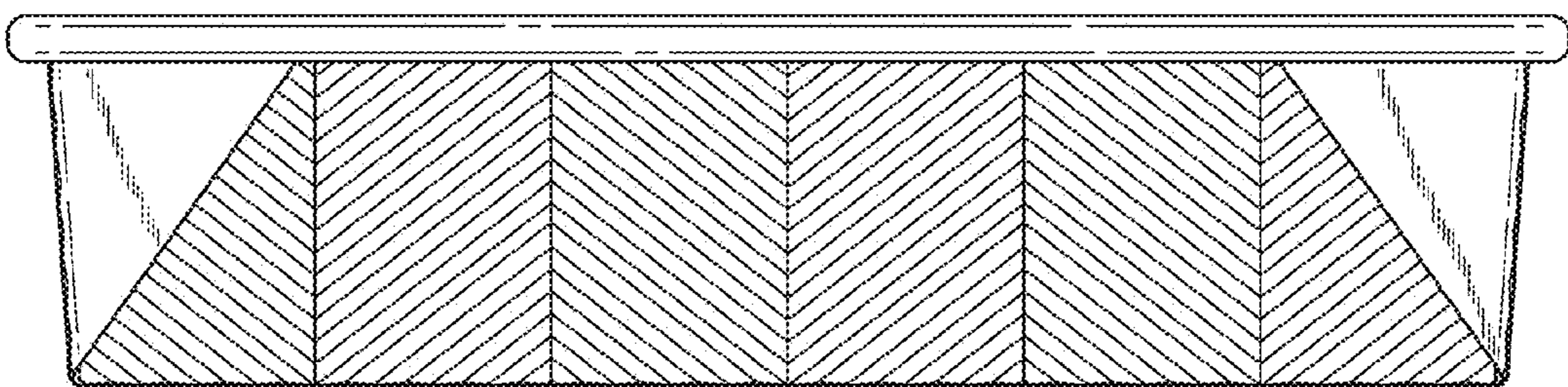

FIG. 10

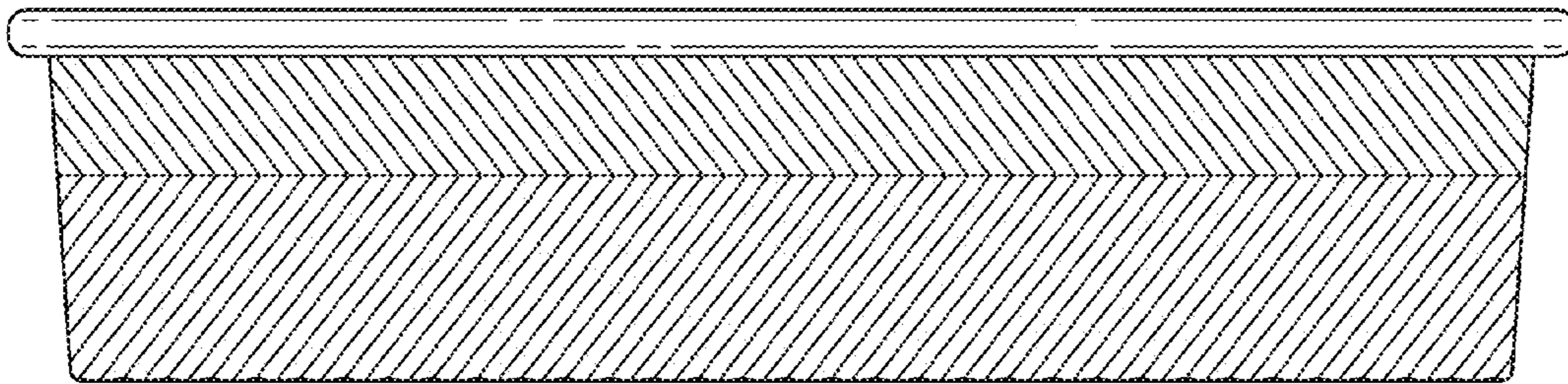

FIG. 11

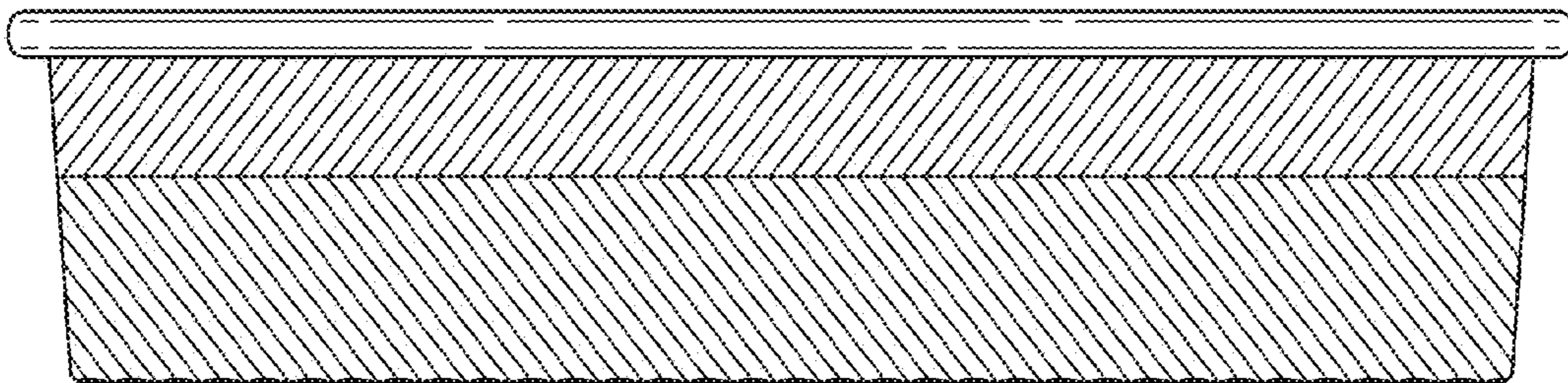

FIG. 12

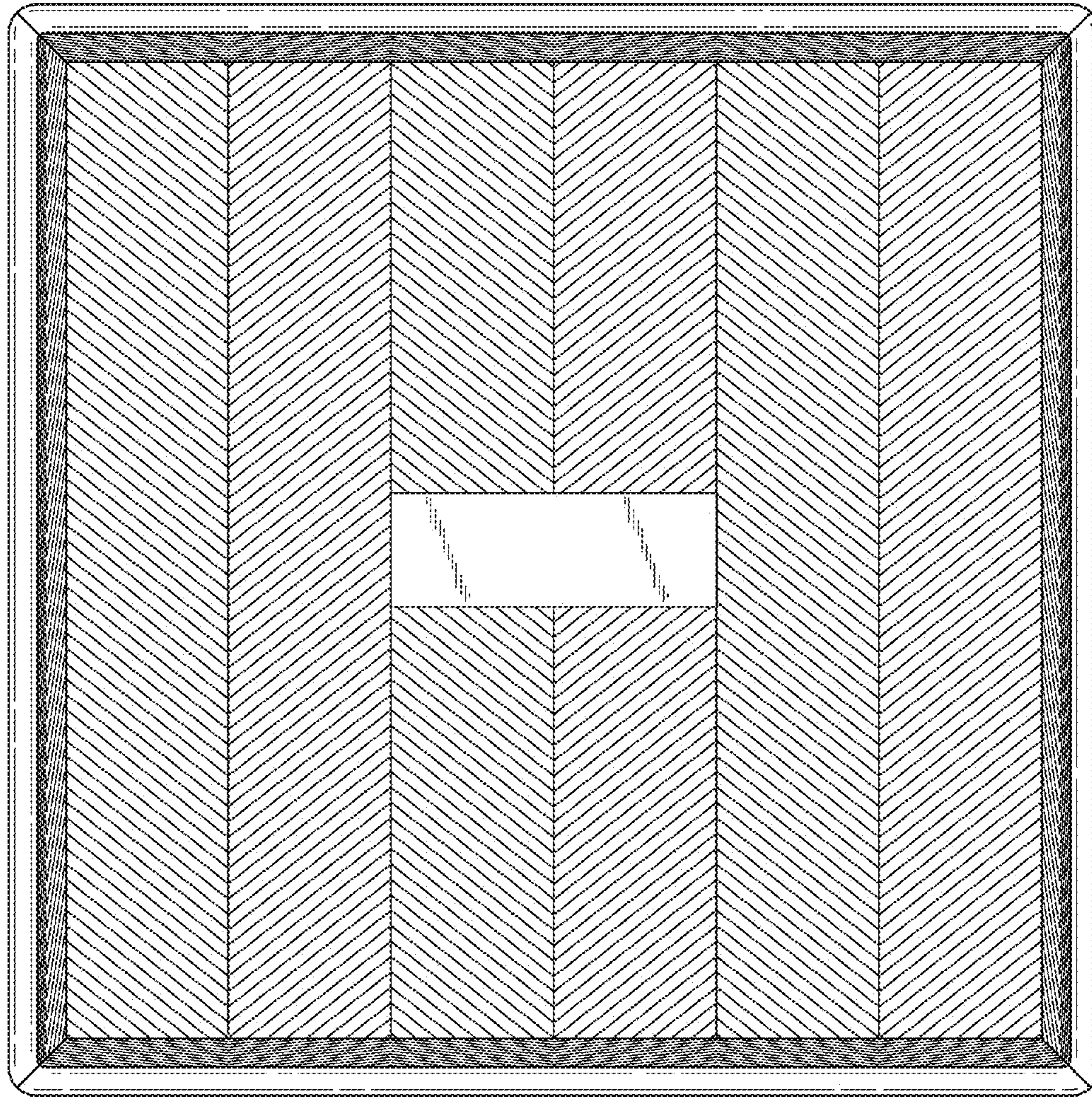

FIG. 13

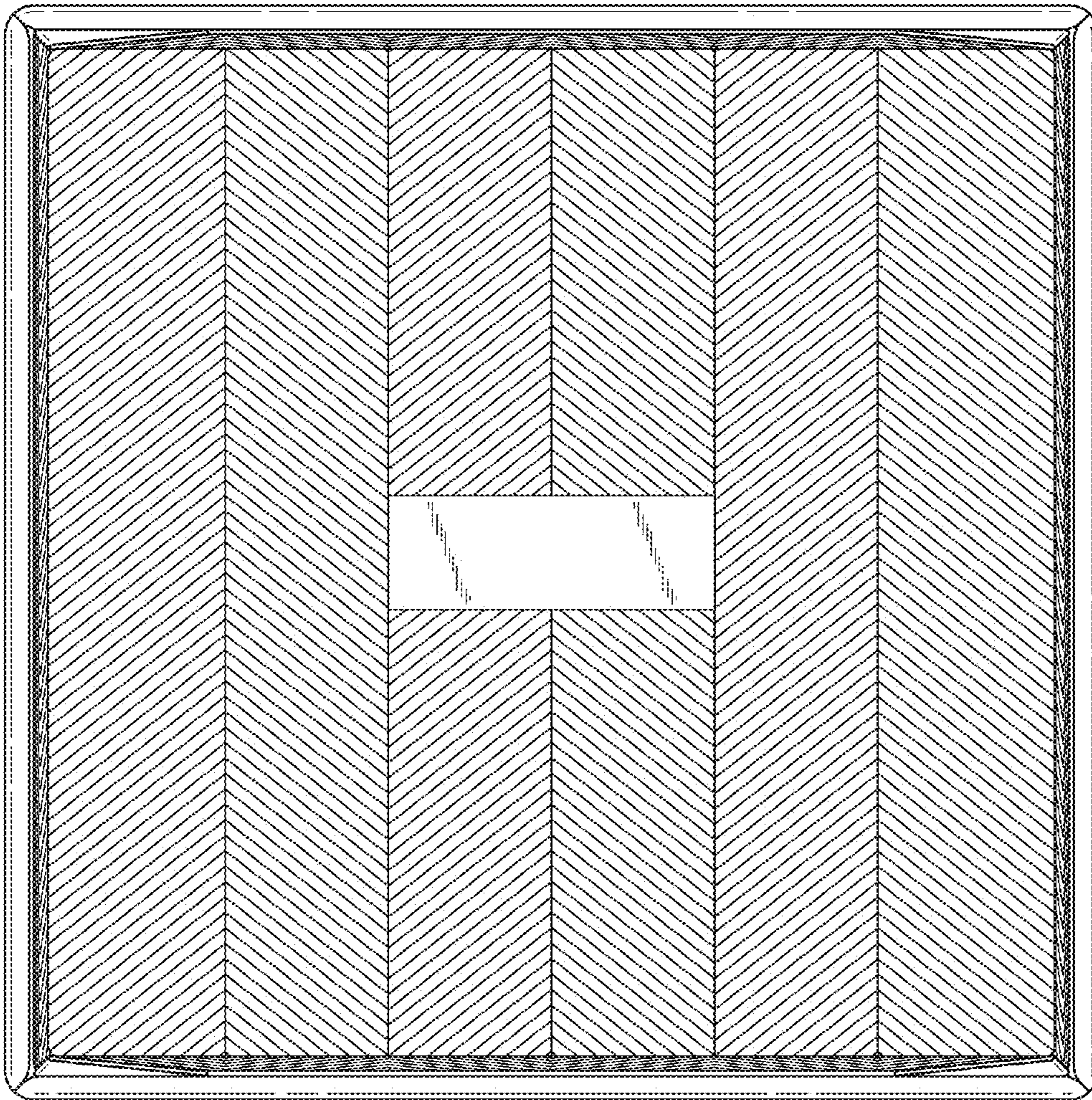

FIG. 14