



US00D757434S

(12) **United States Design Patent**
Beilman et al.

(10) **Patent No.:** **US D757,434 S**

(45) **Date of Patent:** **** May 31, 2016**

(54) **COSMETICS CASE**

2,916,841 A 12/1959 Denis
D230,773 S 3/1974 Arnold
3,921,649 A 11/1975 Milbrath

(Continued)

(71) Applicants: **Debra L Beilman**, Aventura, FL (US);
Florencia Crosa, North Miami, FL
(US); **Bea Moreno**, Davie, FL (US)

FOREIGN PATENT DOCUMENTS

(72) Inventors: **Debra L Beilman**, Aventura, FL (US);
Florencia Crosa, North Miami, FL
(US); **Bea Moreno**, Davie, FL (US)

GB 2363712 A 1/2002

OTHER PUBLICATIONS

(**) Term: **14 Years**

Avon Lady of NJ blog. "Are you set to give?!", posted Nov. 23, 2013.
Accessed Nov. 2, 2015. p. 2 "Gilded Treasures Makeup Set" (<http://avonladynj.com/2013/11/23/are-you-set-to-give/>).*

(Continued)

(21) Appl. No.: **29/495,147**

(22) Filed: **Jun. 27, 2014**

(51) **LOC (10) Cl.** **03-01**

Primary Examiner — Jennifer Rivard

(52) **U.S. Cl.**

Assistant Examiner — April Rivas

USPC **D3/284**; D3/290; D3/299; D3/901;
D28/76

(74) *Attorney, Agent, or Firm* — Malloy & Malloy, P.L.

(58) **Field of Classification Search**

(57) **CLAIM**

USPC D28/76, 78, 83, 82, 85, 86, 77, 64.3;
D3/273, 275, 276, 282, 284, 288, 290,
D3/292, 294, 295, 296, 297, 299, 301, 302,
D3/903, 901, 303

The ornamental design for cosmetics case, as shown and described.

CPC B65D 85/72; A45D 40/24; A45D 40/00;
A45D 40/18; A45D 40/22; A45D 33/00;
A45D 33/03; A45D 33/006; A45D 33/008;
A45D 33/20; A45D 2040/0012

DESCRIPTION

See application file for complete search history.

FIG. 1 is a front perspective view in first open orientation illustrating my design for a cosmetics case;
FIG. 2 is a front perspective view in a second open orientation view thereof;
FIG. 3 is a front perspective view in a third open orientation view thereof;
FIG. 4 is a front view thereof;
FIG. 5 is a left side view thereof;
FIG. 6 is a top view in a first open orientation thereof;
FIG. 7 is a right side view thereof;
FIG. 8 is a bottom view thereof;
FIG. 9 is a rearview thereof;
FIG. 10 is a front perspective view in closed orientation; and,
FIG. 11 is a front view in a closed orientation view thereof.
The broken lines illustrate stitching and form part of the claimed design.

(56) **References Cited**

U.S. PATENT DOCUMENTS

1,414,899 A 5/1922 Sabatelli
1,592,457 A 7/1926 Greenberg
2,003,824 A 6/1935 Cavalero
2,084,292 A 6/1937 Steiner
D108,590 S 2/1938 Zell
2,117,140 A 5/1938 Bowen
D111,177 S 9/1938 Gamble
2,278,866 A 4/1942 Dell'Elba
D139,428 S 11/1944 Morris
2,570,314 A 10/1951 Brand
2,649,799 A 8/1953 Spertus

1 Claim, 11 Drawing Sheets

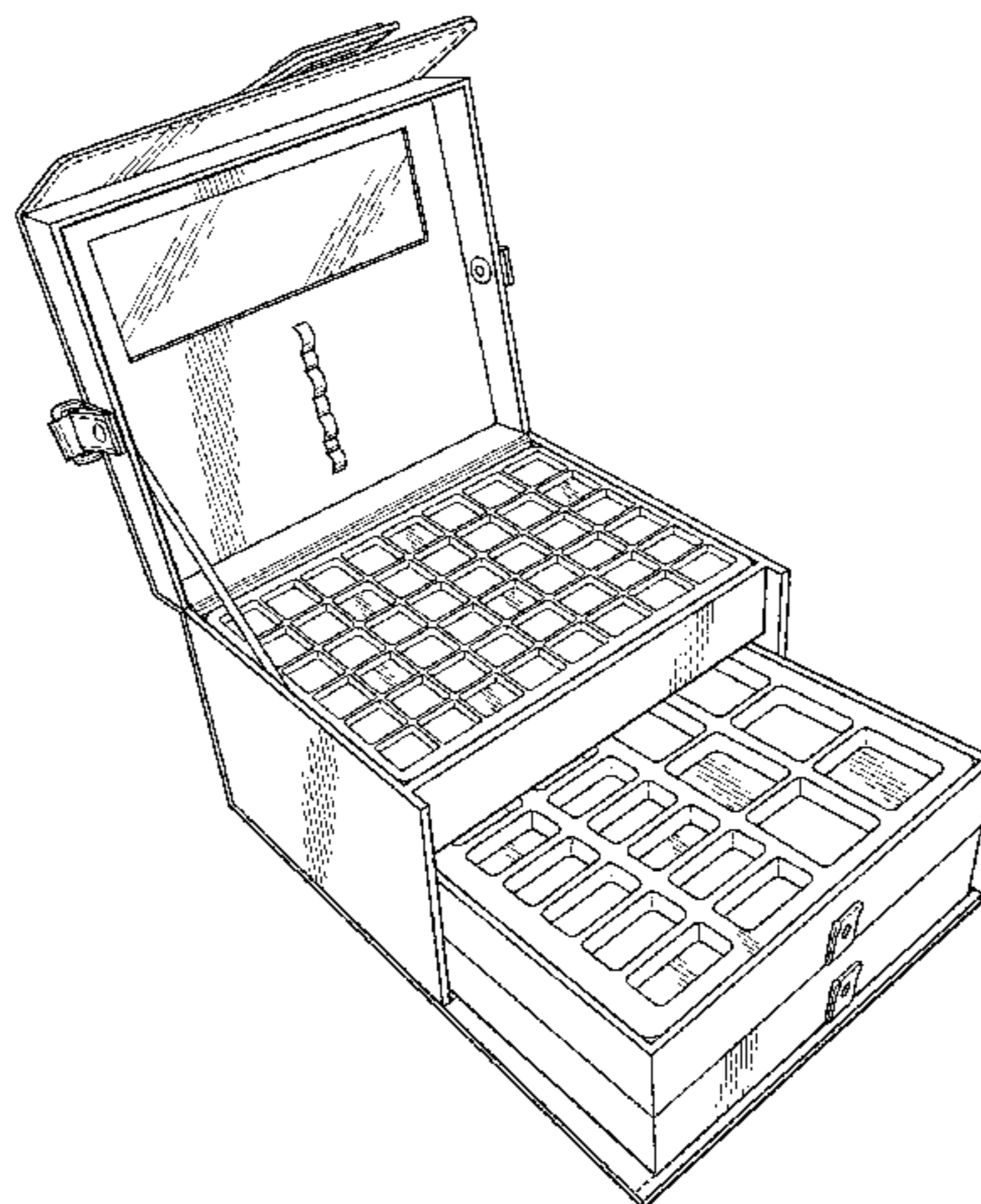

(56)

References Cited

U.S. PATENT DOCUMENTS

4,526,273 A 7/1985 Tsuji et al.
 4,574,944 A 3/1986 Gregory
 D293,724 S 1/1988 Kingsford et al.
 D308,756 S * 6/1990 Turner D28/83
 D321,284 S 11/1991 Marsella et al.
 D344,412 S 2/1994 Barnhart
 5,363,969 A 11/1994 Shen
 5,813,420 A 9/1998 Sussman
 D411,648 S 6/1999 Markham
 D413,627 S 9/1999 Gray
 D417,783 S * 12/1999 Wolf D3/275
 D444,596 S 7/2001 Lai
 6,349,494 B1 2/2002 Haggarty-Robbins
 D455,550 S 4/2002 Wolf
 D457,687 S 5/2002 Millar
 D467,428 S 12/2002 Wolf
 D471,010 S 3/2003 Wolf
 D475,197 S * 6/2003 Stoddard D3/284
 D475,811 S 6/2003 Bontempo
 D480,211 S 10/2003 Wolf
 D485,018 S 1/2004 Beilman
 D485,067 S * 1/2004 Wolf D3/291
 D485,682 S * 1/2004 Wolf D3/291
 D493,919 S 8/2004 Beilman
 D510,189 S * 10/2005 Greiner D3/284
 D517,737 S 3/2006 Lai
 D524,989 S 7/2006 Lombardi
 D527,521 S 9/2006 Sijmons
 D542,475 S 5/2007 Martinez
 D577,196 S * 9/2008 Hayden D3/286
 D614,814 S * 4/2010 Lin D28/83
 D631,201 S * 1/2011 Lai D28/73
 D657,915 S * 4/2012 Lai D28/83
 D671,742 S * 12/2012 Cenzano D3/272
 D687,187 S * 7/2013 Lai D28/83
 D688,006 S 8/2013 Lai
 D688,831 S 8/2013 Giardina
 D692,183 S * 10/2013 Lai D28/73

D723,794 S * 3/2015 Lai D28/83
 D728,860 S 5/2015 Blanch
 D734,549 S * 7/2015 Waller D28/73
 D735,993 S 8/2015 Koepke et al.
 2004/0003825 A1 1/2004 Kelly
 2007/0235056 A1 10/2007 Vintimiglia et al.
 2014/0299151 A1 * 10/2014 Stroud A45D 33/008
 132/315

OTHER PUBLICATIONS

The Cosmetic Center Advertising Circular, 1991, second page item Q on lower left.
 Hong Kong Enterprise June 1993, p. 202: Item No. G902OB.
 Hong Kong Enterprise October 1994, p. 760: Item No. M17D.
 Cameo Cosmetics. "M229 Train Case". Accessed Nov. 2, 2015. (<http://www.cameocosmetics.com/m229-train-case/>).
 Google Image search. "Ulta Sparkle Shine Kit", Accessed Nov. 2, 2015. (https://www.google.com/search?q=ulta+sparkle+shine+kit&es_sm=122&source=lnms&tbn=isch&sa=X&ved=0CAgQ_AUoAmoVChMlu47-5Y_yyAIVgWomCh0mWgkD&biw=1920&bih=1067#imgrc=uWr-Z3gEyjn0MM%3A).
 Giordano Colors, "Catalog" p. 2, item indicated with arrow. Accessed Oct. 30, 2015. (<http://www.giordanocolors.com/#!/products/c24vq>).
 Amazon.com, "Shany All in One Makeup Kit". Reviewed Nov. 12, 2012. Accessed Sep. 30, 2015. (http://www.amazon.com/SHANY-Eyeshadow-Blushes-Lipstick-Exclusive/dp/B008PWOPY6/ref=cm_cr_pr_product_top?ie=UTF8).
 Amazon.com, "Ivation All-In-One Makeup Kit in Highly Fashionable Red Leather-look Train Case". Reviewed Sep. 21, 2014. Accessed Oct. 30, 2015. (http://www.amazon.com/Ivation-All-In-One-Makeup-Fashionable-Leather-look/dp/B00N9A78HG/ref=cm_cr_pr_product_top?ie=UTF8).
 YouTube.com user "Supermodel Secrets", "Listen Listen Listen! Shany USA Home and Professional Make Up Sets Review" Video published Jan. 2, 2013. Accessed Oct. 30, 2015. (<https://www.youtube.com/watch?v=9NbzrCG2D2U>).

* cited by examiner

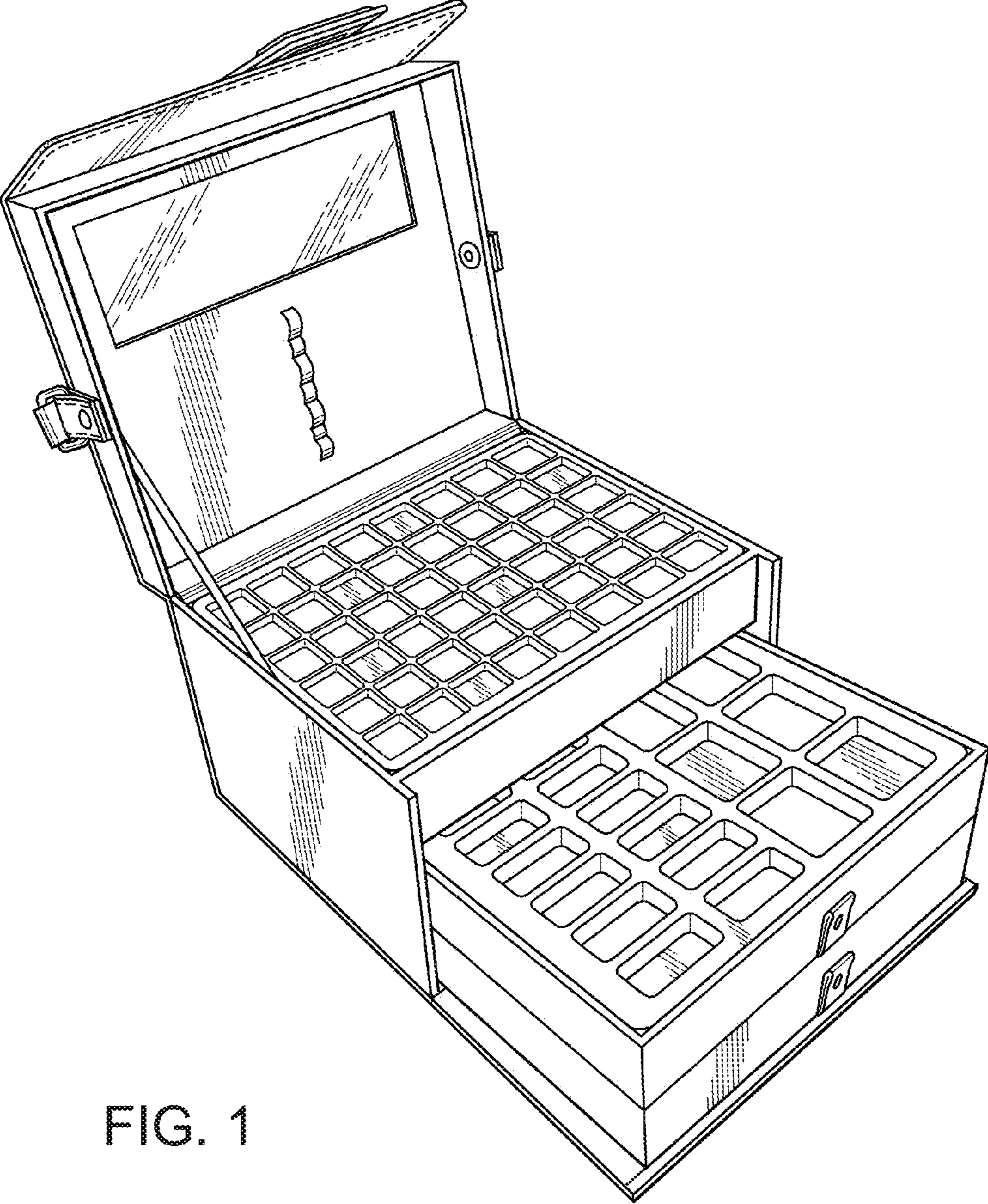

FIG. 1

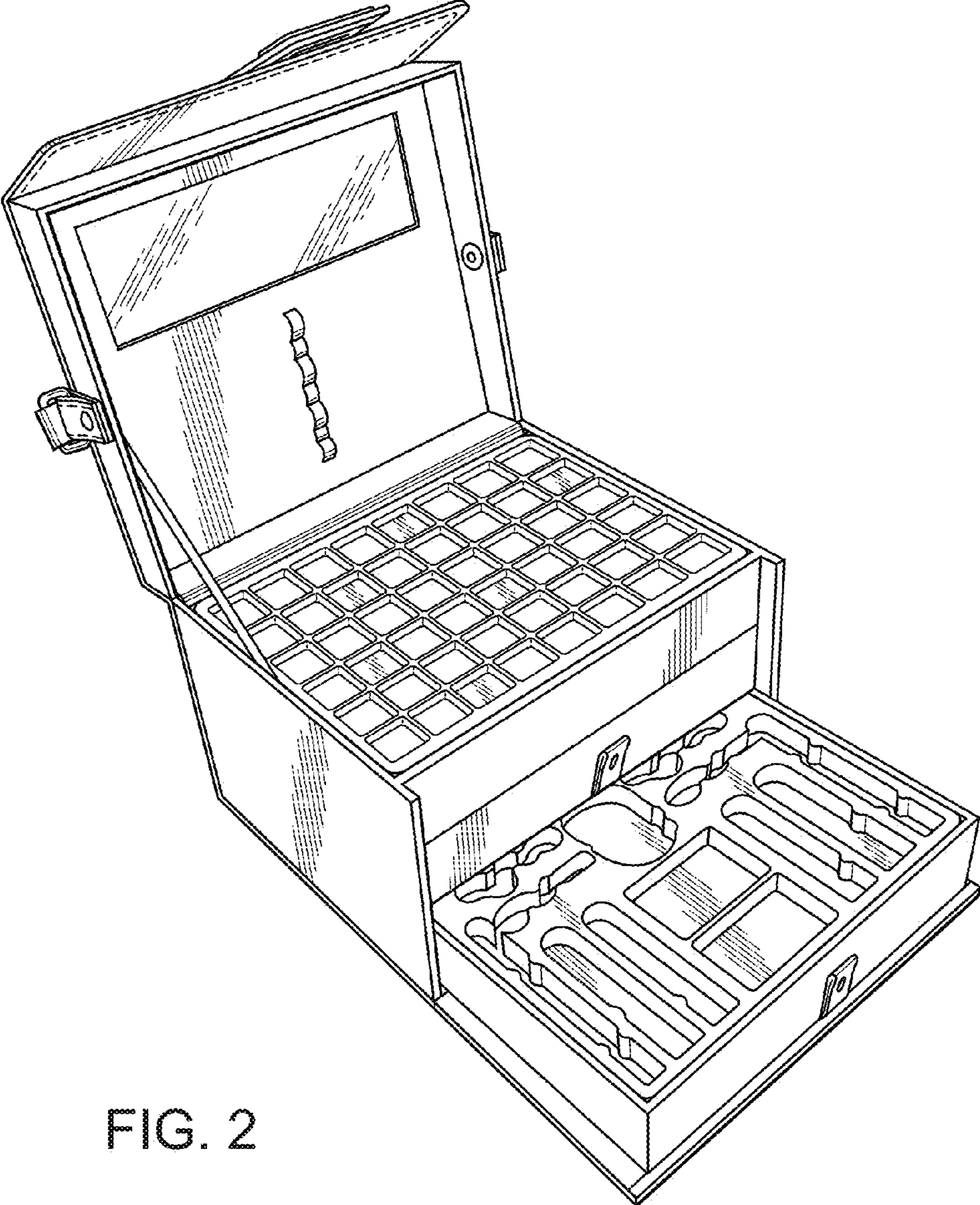

FIG. 2

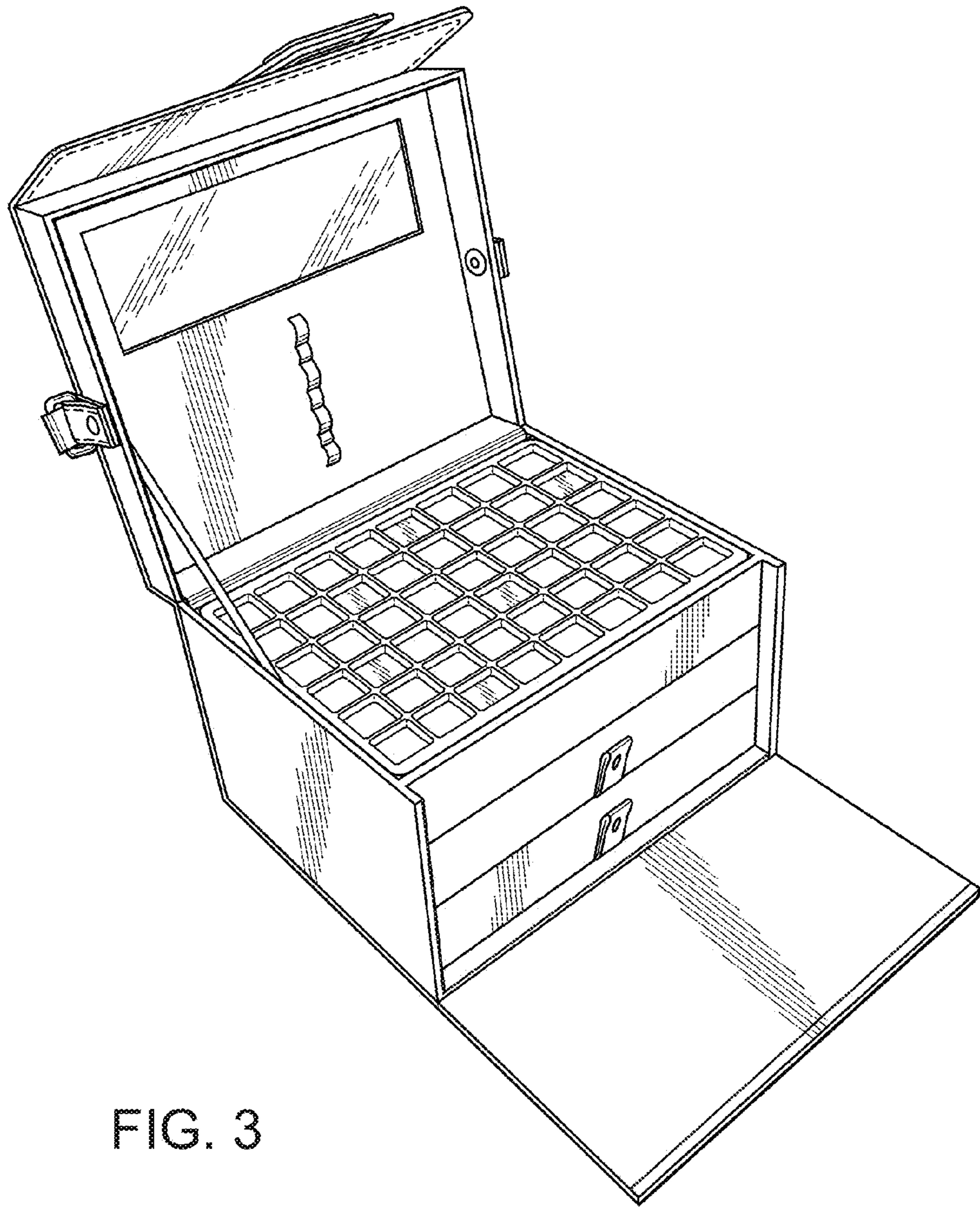

FIG. 3

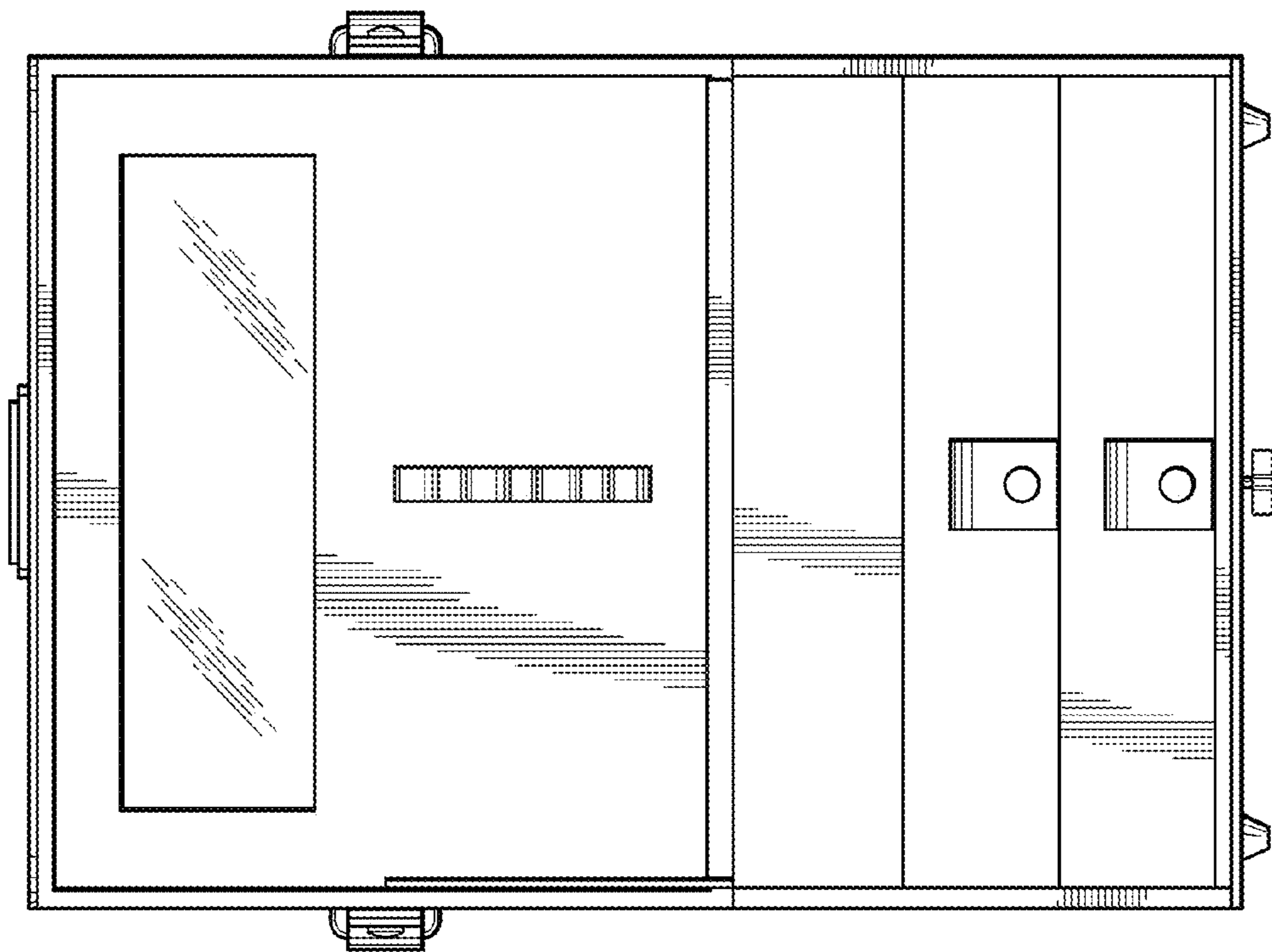

FIG. 4

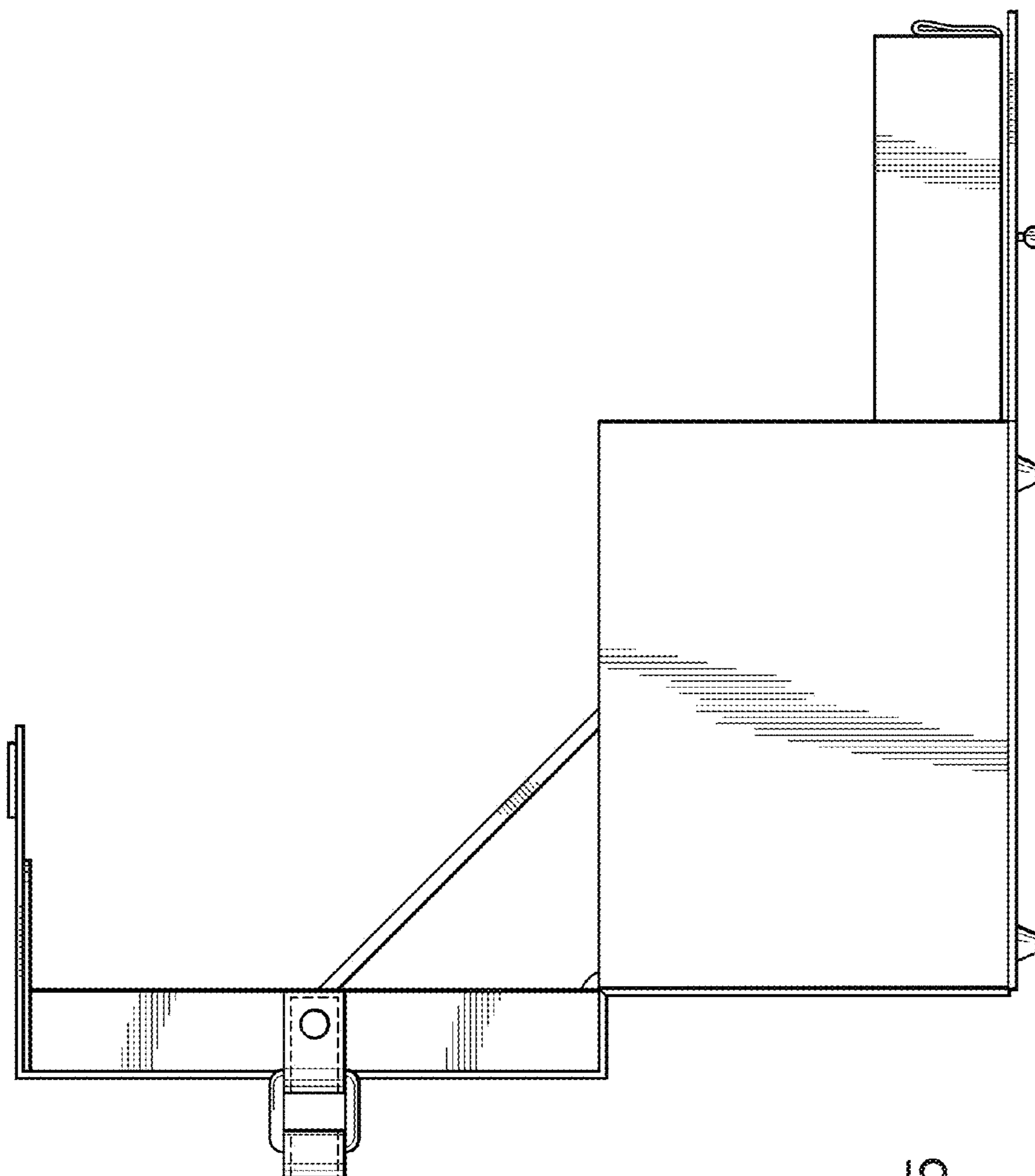

FIG. 5

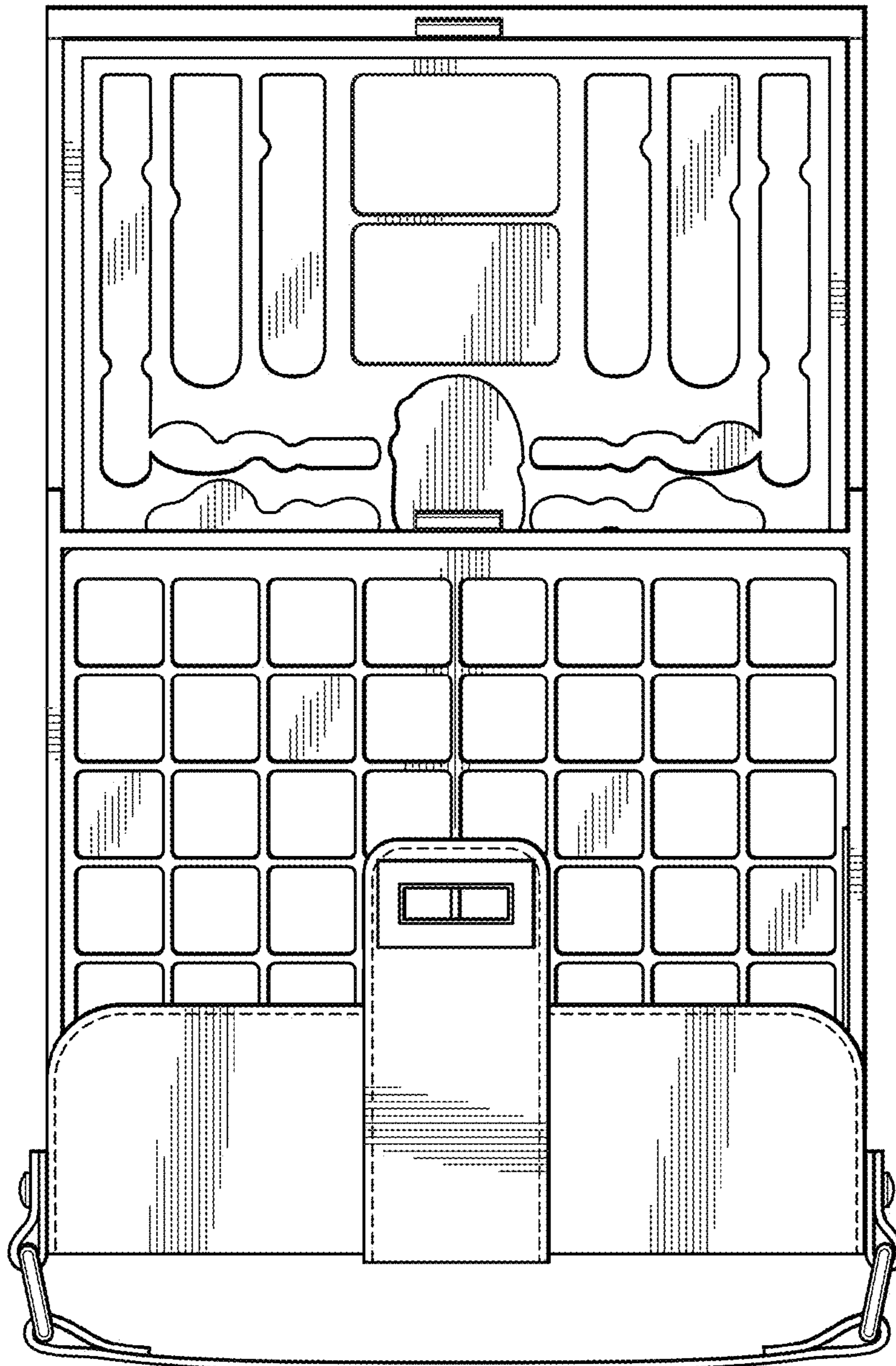

FIG. 6

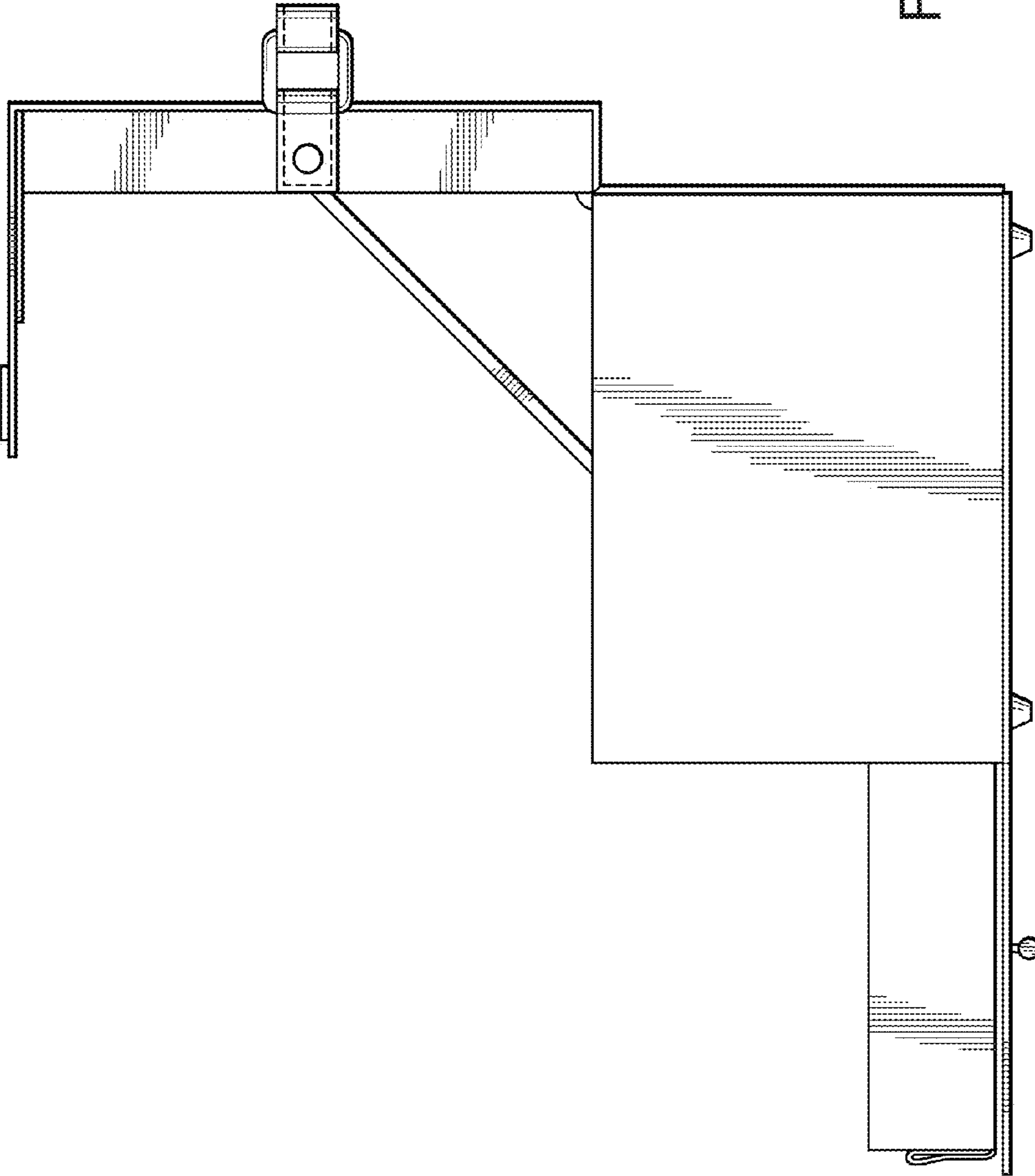

FIG. 7

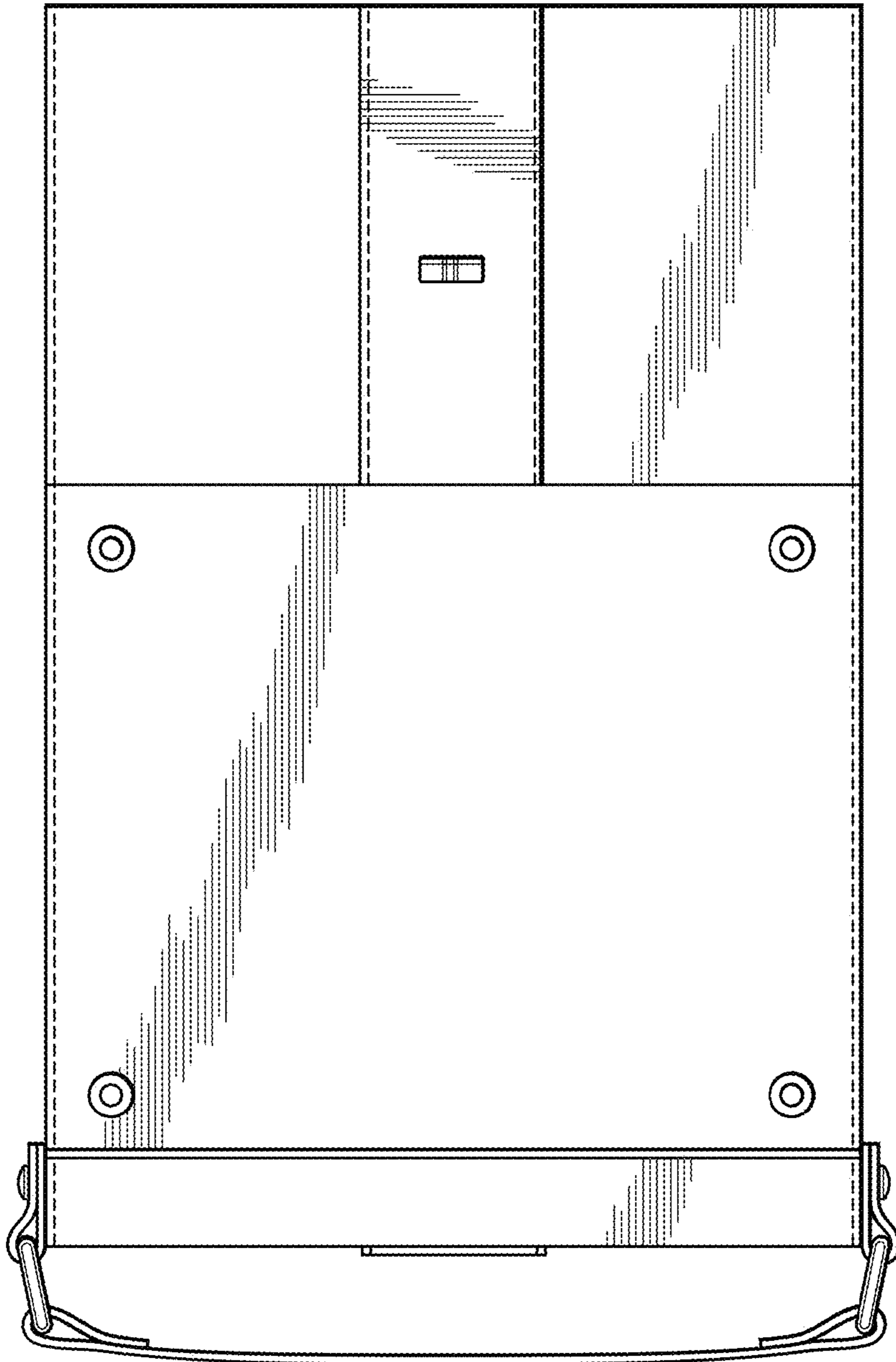

FIG. 8

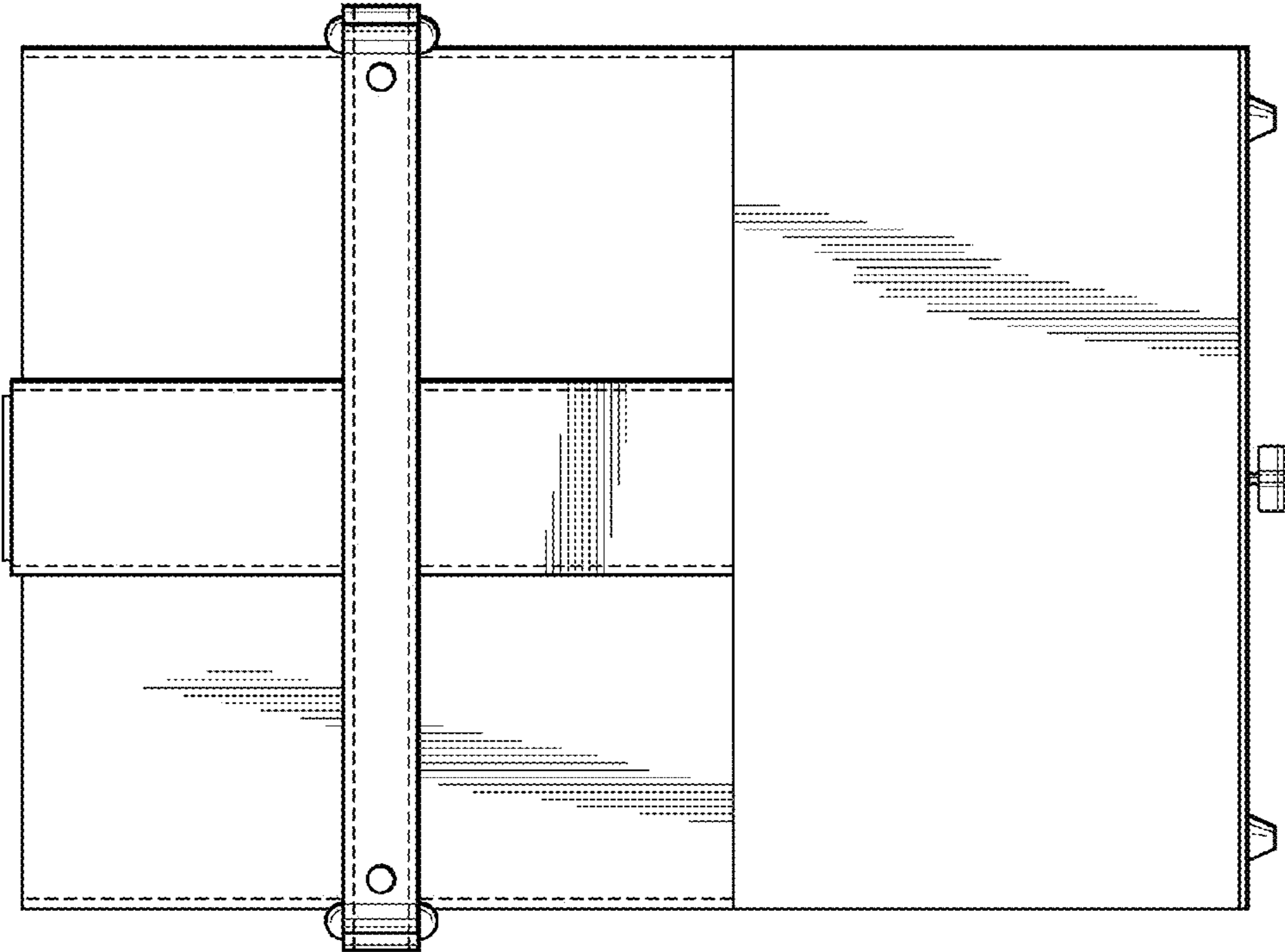

FIG. 9

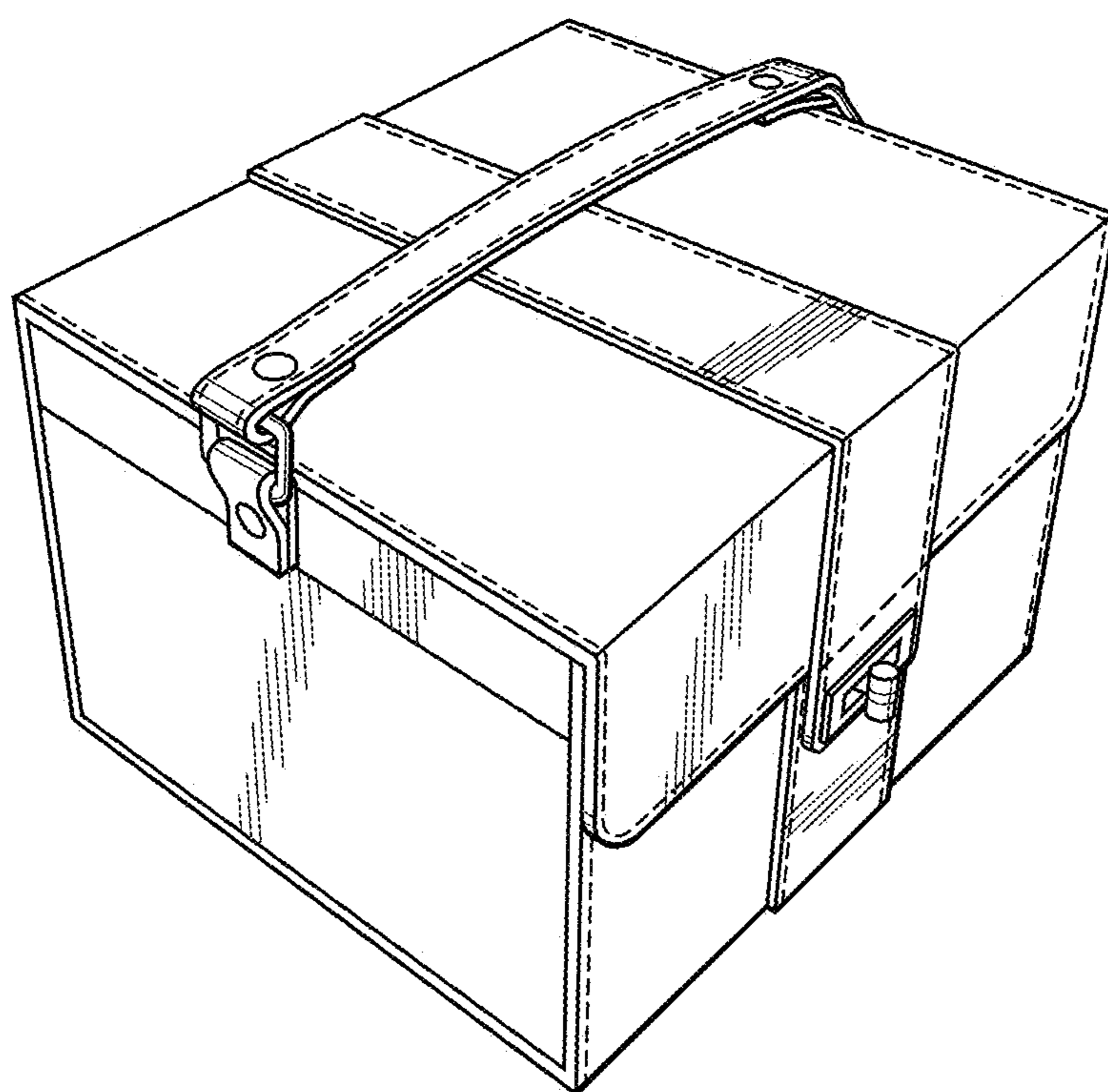

FIG. 10

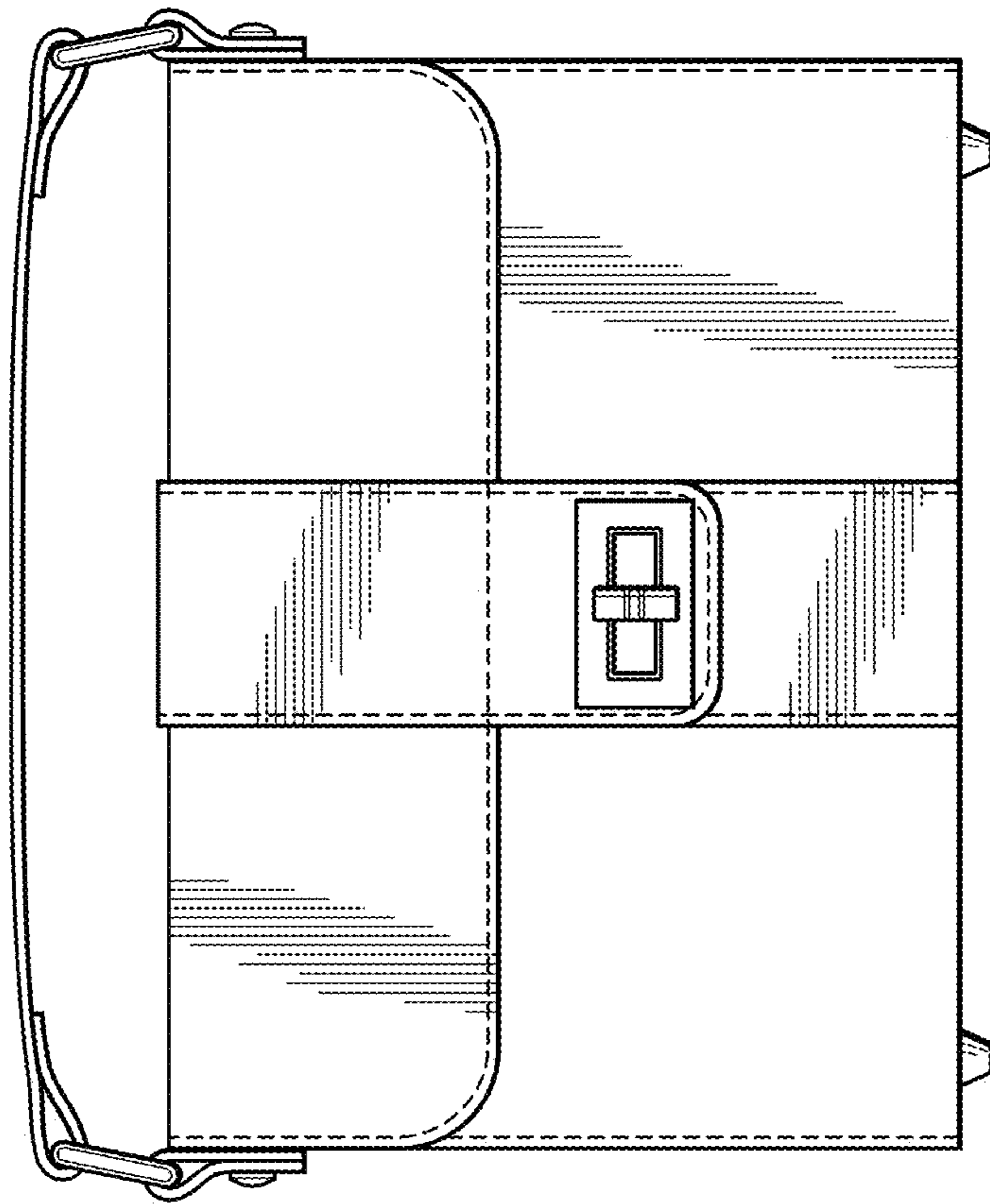

FIG. 11