

US00D757406S

(12) **United States Design Patent**  
**Stillwagon**

(10) **Patent No.:** **US D757,406 S**

(45) **Date of Patent:** **\*\* May 31, 2016**

(54) **ZIPPER BOOT**

(71) Applicant: **Elizabeth Stillwagon**, Chula Vista, CA  
(US)

(72) Inventor: **Elizabeth Stillwagon**, Chula Vista, CA  
(US)

(\*\*) Term: **14 Years**

(21) Appl. No.: **29/510,195**

(22) Filed: **Nov. 25, 2014**

(51) **LOC (10) Cl.** ..... **02-04**

(52) **U.S. Cl.**  
USPC ..... **D2/925; D2/910**

(58) **Field of Classification Search**  
USPC ..... D2/896, 909–911, 925–942, 969, 970,  
D2/971  
CPC ..... A43B 21/00; A43B 21/02; A43B 21/06;  
A43B 9/14; A43B 1/0045; A43B 13/10;  
A43B 13/12; A43B 23/06; A43B 23/07;  
A43B 1/0036; A43B 5/12; A43B 3/02  
See application file for complete search history.

(56) **References Cited**

**U.S. PATENT DOCUMENTS**

- 1,442,392 A \* 1/1923 Gantenbein ..... A43B 3/02  
36/1.5
- 2,054,958 A \* 9/1936 Tousley ..... A43B 3/02  
36/1.5
- D282,408 S \* 2/1986 Nissenbaum ..... D2/910
- D337,195 S \* 7/1993 Vick ..... D2/911
- D529,689 S \* 10/2006 Choi ..... D2/911

- D625,095 S \* 10/2010 Issler ..... D2/911
- D629,597 S \* 12/2010 Ng ..... D2/911
- D647,287 S \* 10/2011 Seelert ..... D2/911
- 8,863,406 B2 \* 10/2014 Moore ..... A43B 3/02  
36/1.5

\* cited by examiner

*Primary Examiner* — Dominic Simone

(74) *Attorney, Agent, or Firm* — Gary L. Eastman, Esq.

(57) **CLAIM**

The ornamental design for a zipper boot, as shown and described.

**DESCRIPTION**

FIG. 1 is a front upper perspective view of the zipper boot;  
 FIG. 2 is a back lower perspective view of the zipper boot;  
 FIG. 3 is a left side view of the zipper boot;  
 FIG. 4 is a right side view of the zipper boot;  
 FIG. 5 is a front view of the zipper boot;  
 FIG. 6 is a back view of the zipper boot;  
 FIG. 7 is a top view of the zipper boot;  
 FIG. 8 is a bottom view of the zipper boot;  
 FIG. 9 is a front perspective view of an alternative view of the zipper boot, excluding the middle section of the zipper boot;  
 FIG. 10 is an exploded front upper perspective view of the zipper boot;  
 FIG. 11 is an exploded back lower perspective view of the zipper boot;  
 FIG. 12 is an exploded left side view of the zipper boot;  
 FIG. 13 is an exploded right side view of the zipper boot;  
 FIG. 14 is an exploded front view of the zipper boot;  
 FIG. 15 is an exploded back view of the zipper boot;  
 FIG. 16 is an exploded top view of the zipper boot; and,  
 FIG. 17 is an exploded bottom view of the zipper boot.

**1 Claim, 12 Drawing Sheets**

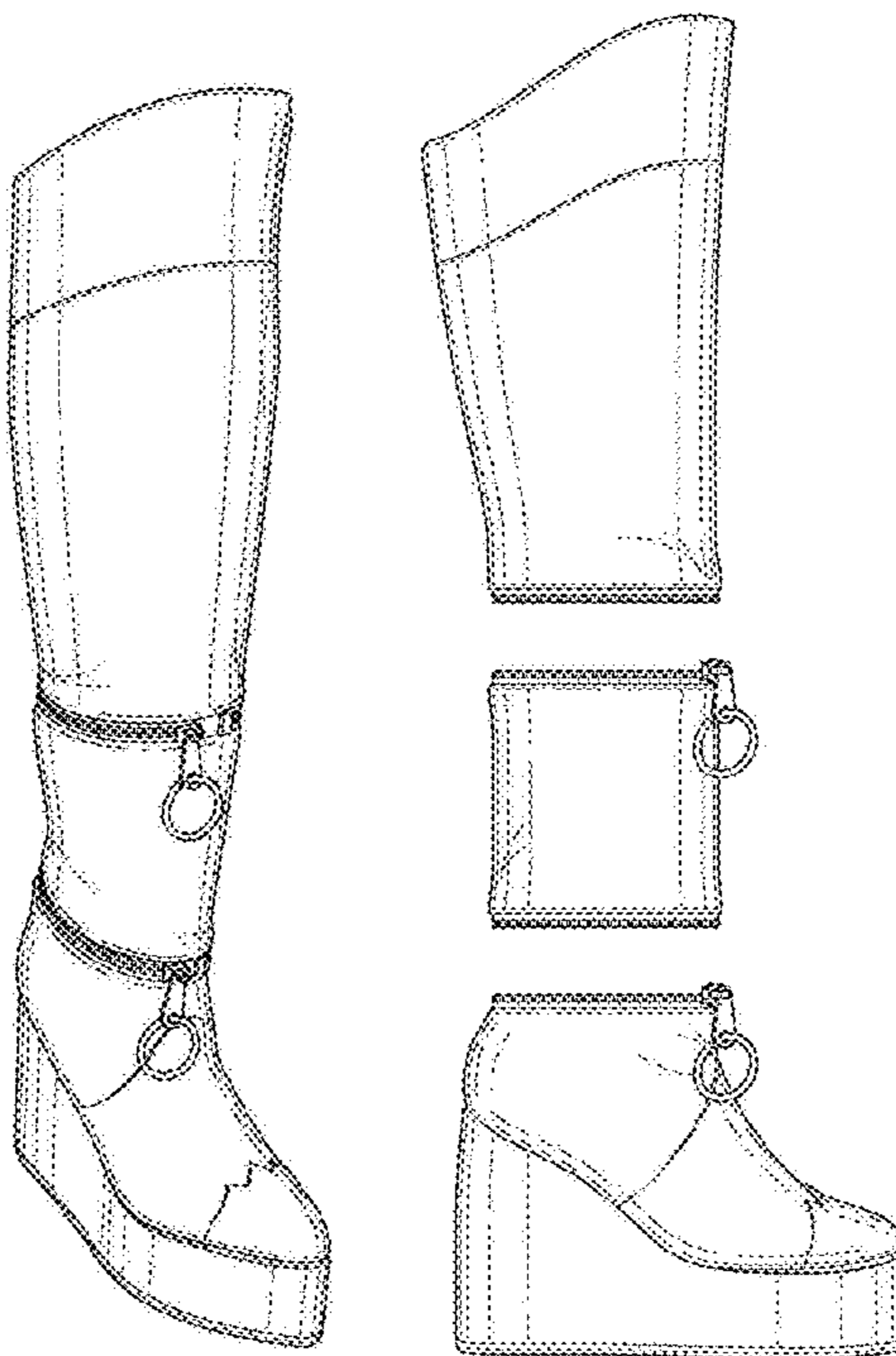

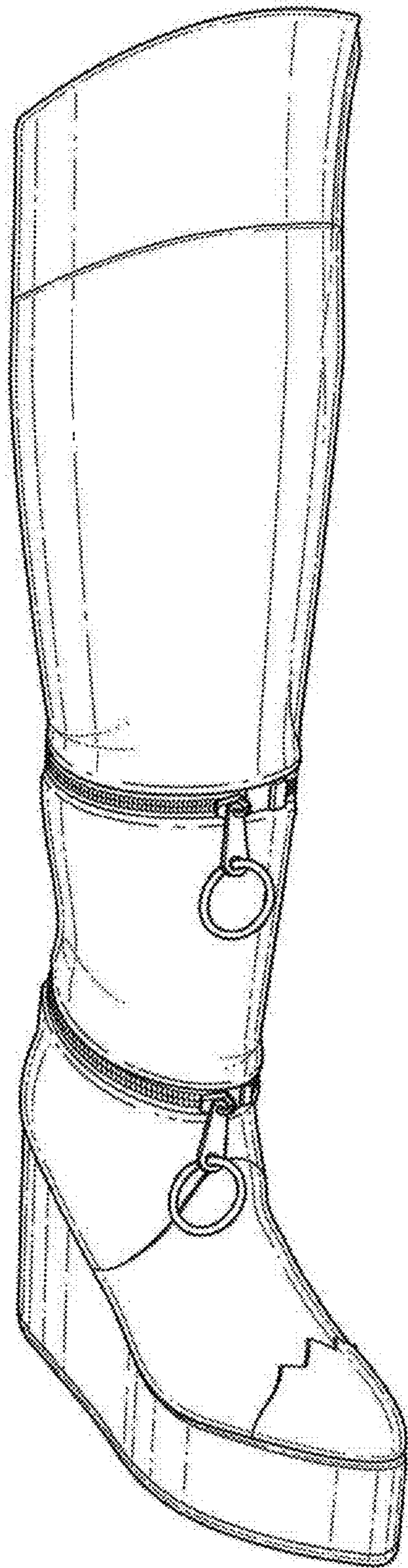

FIG. 1

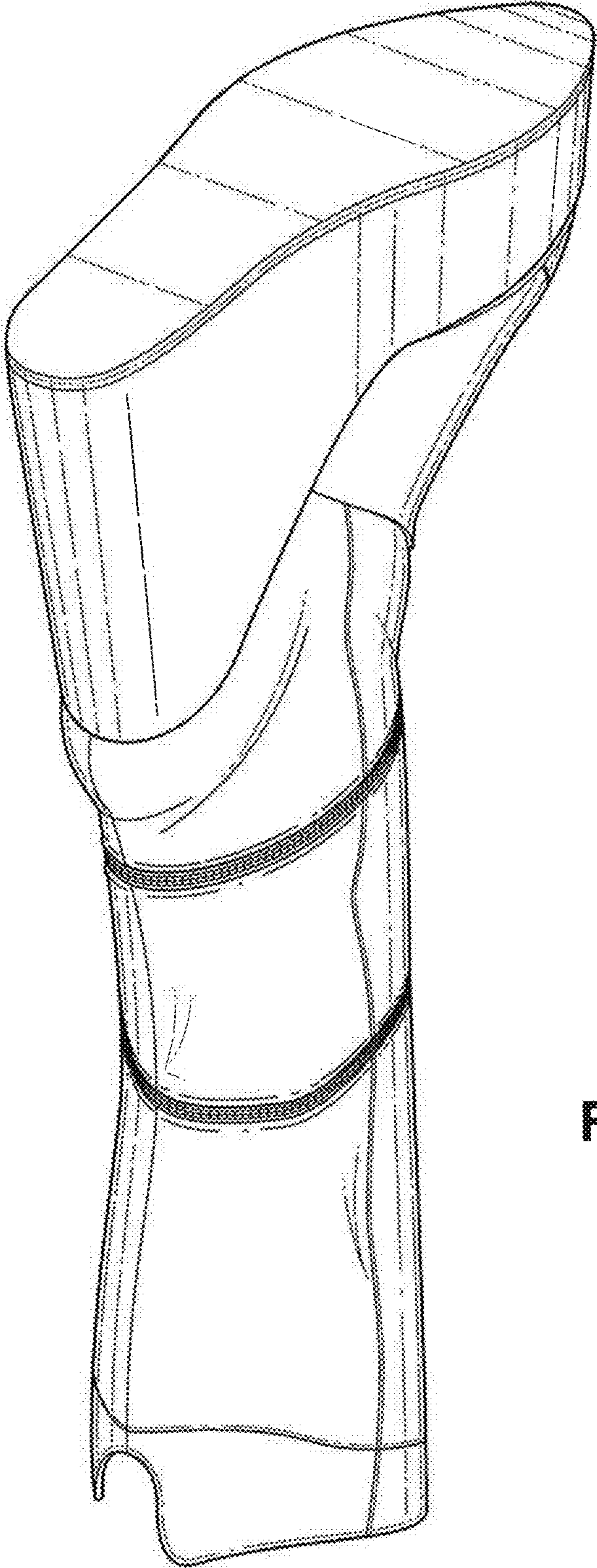

FIG. 2

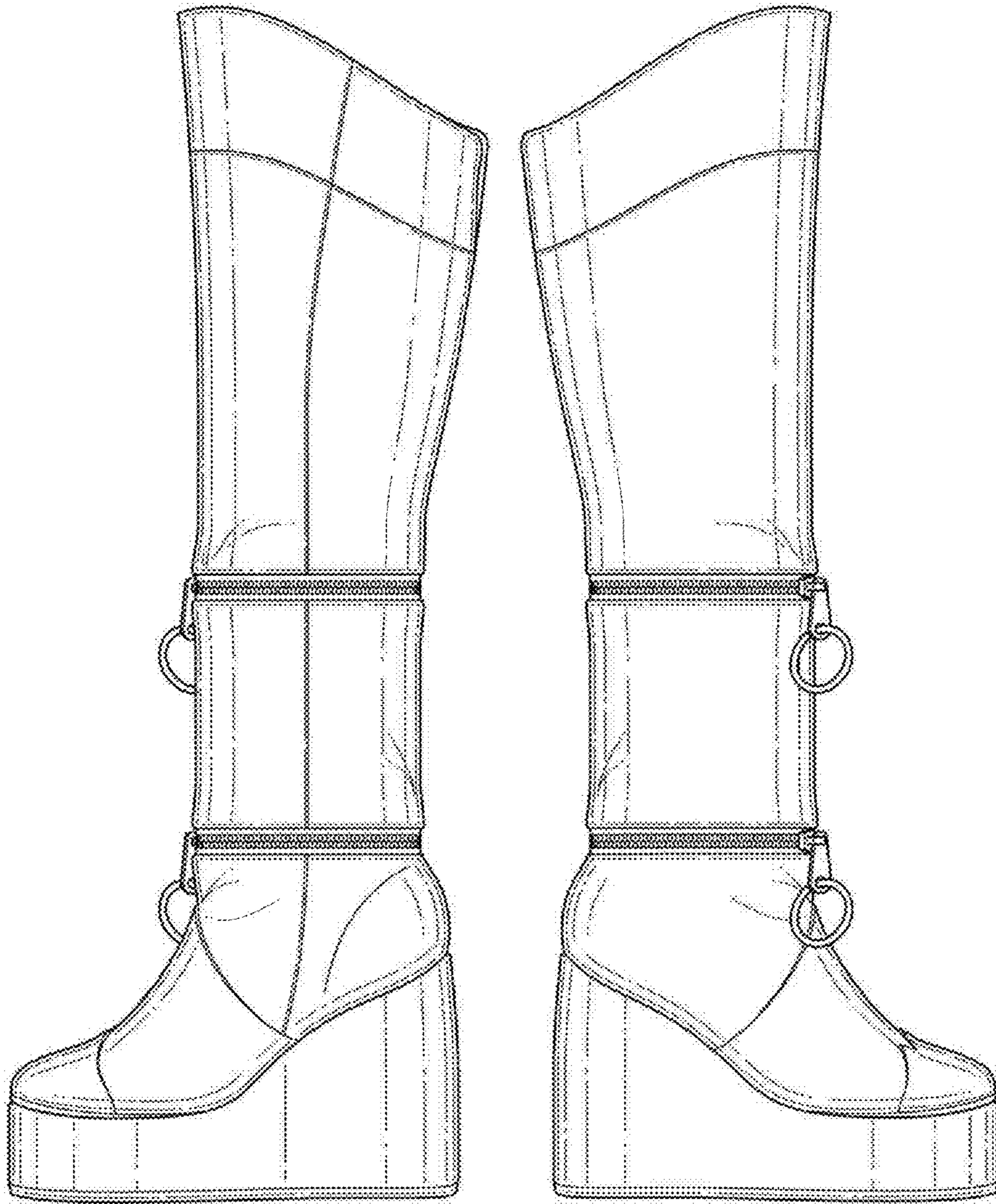

FIG. 3

FIG. 4

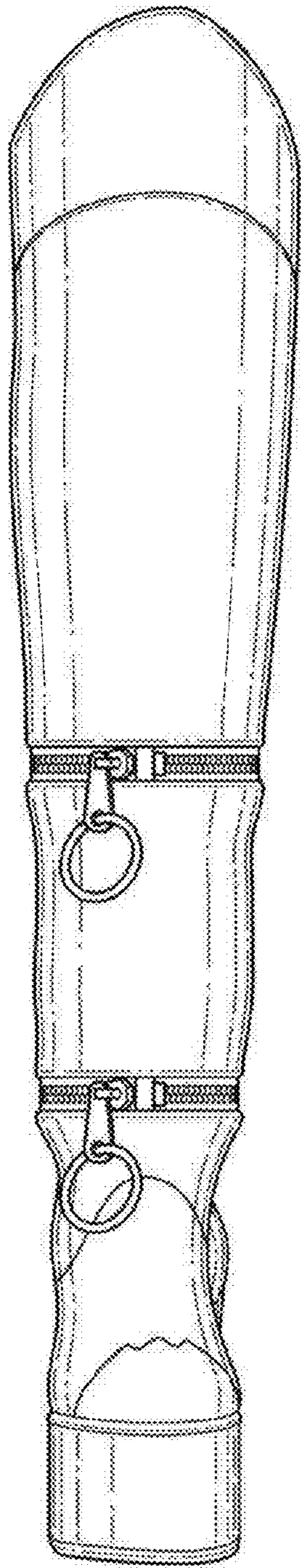

FIG. 5

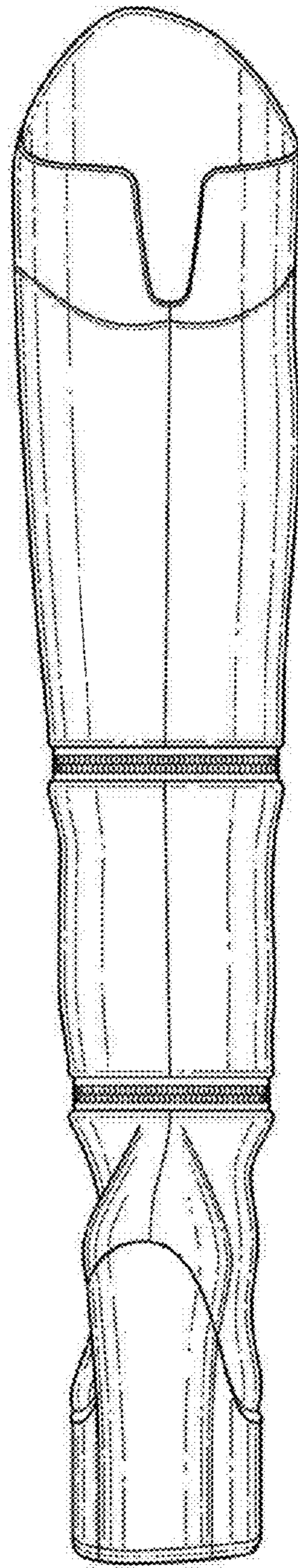
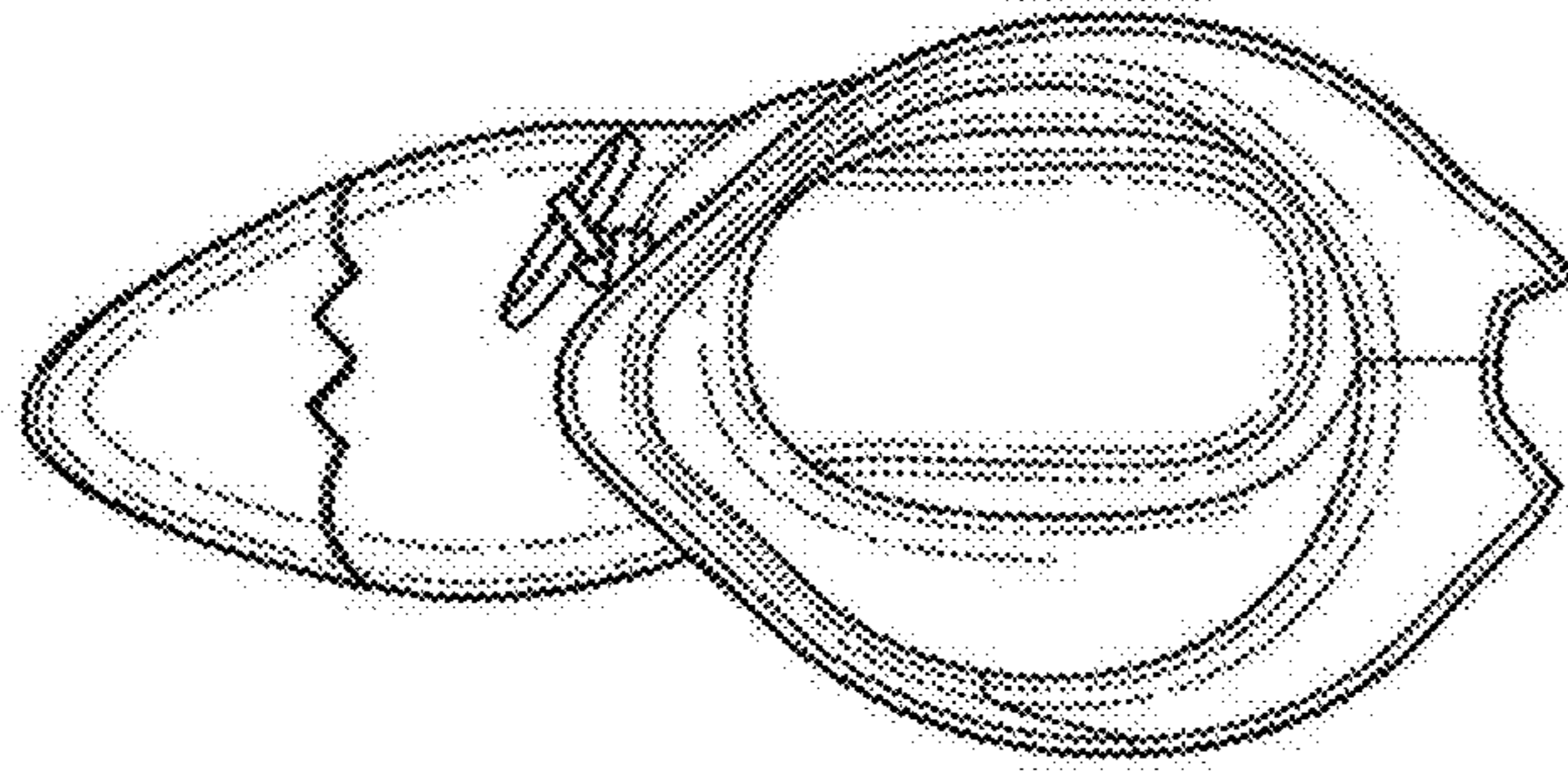
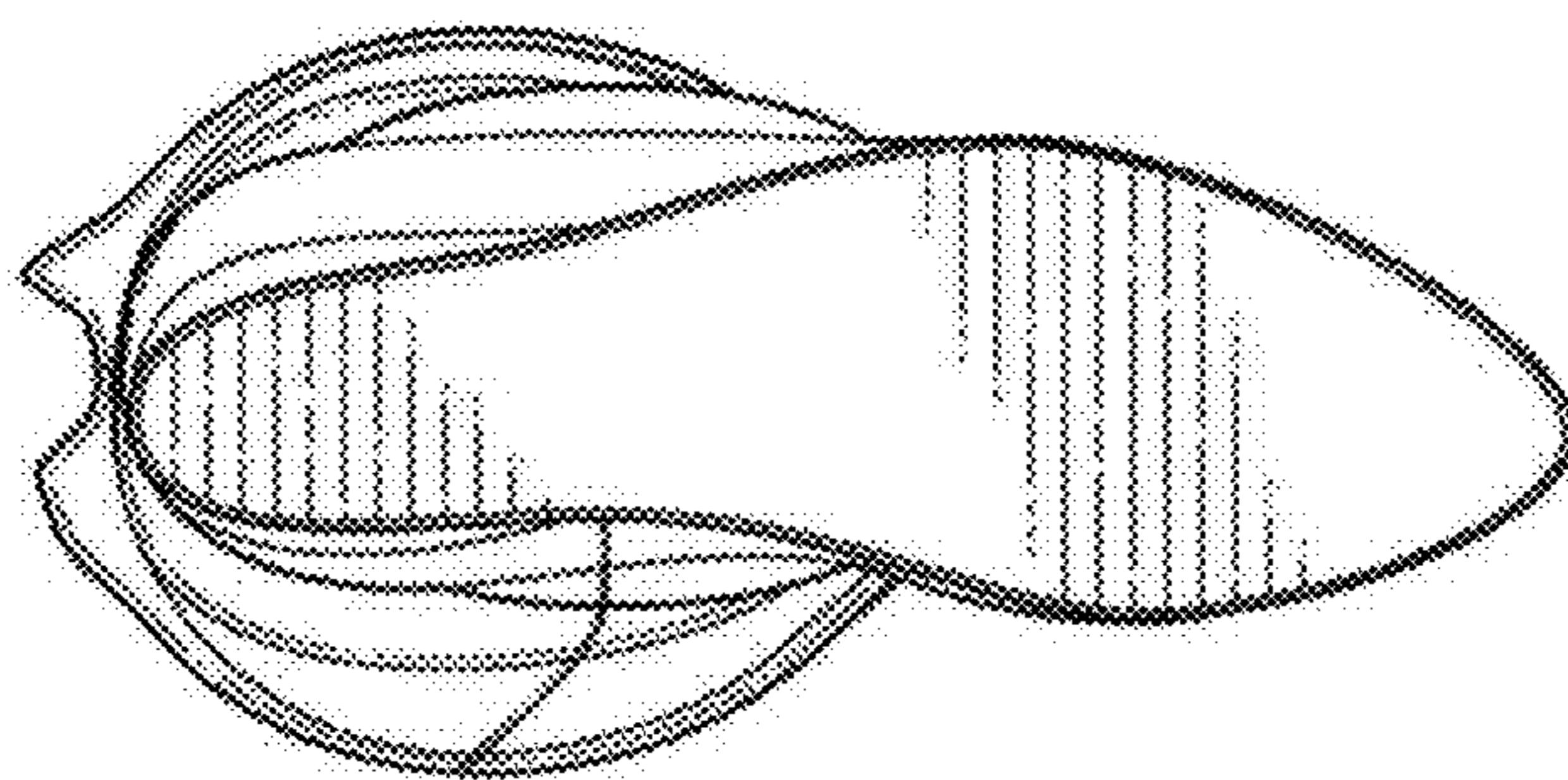

FIG. 6



**FIG. 7**



**FIG. 8**

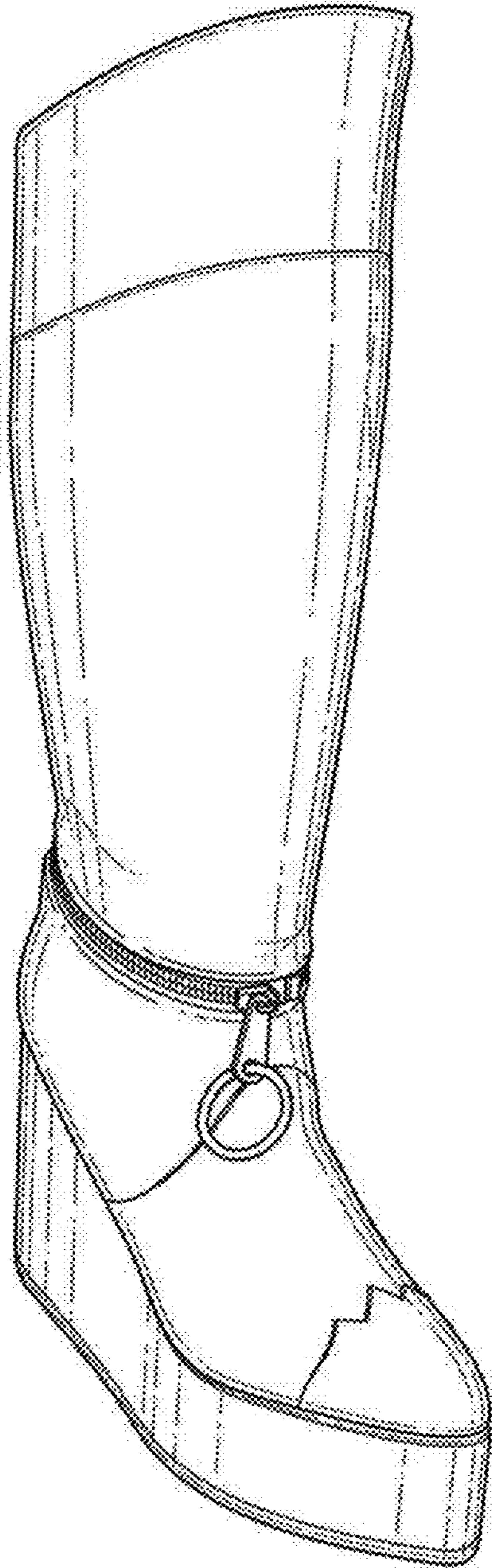

FIG. 9

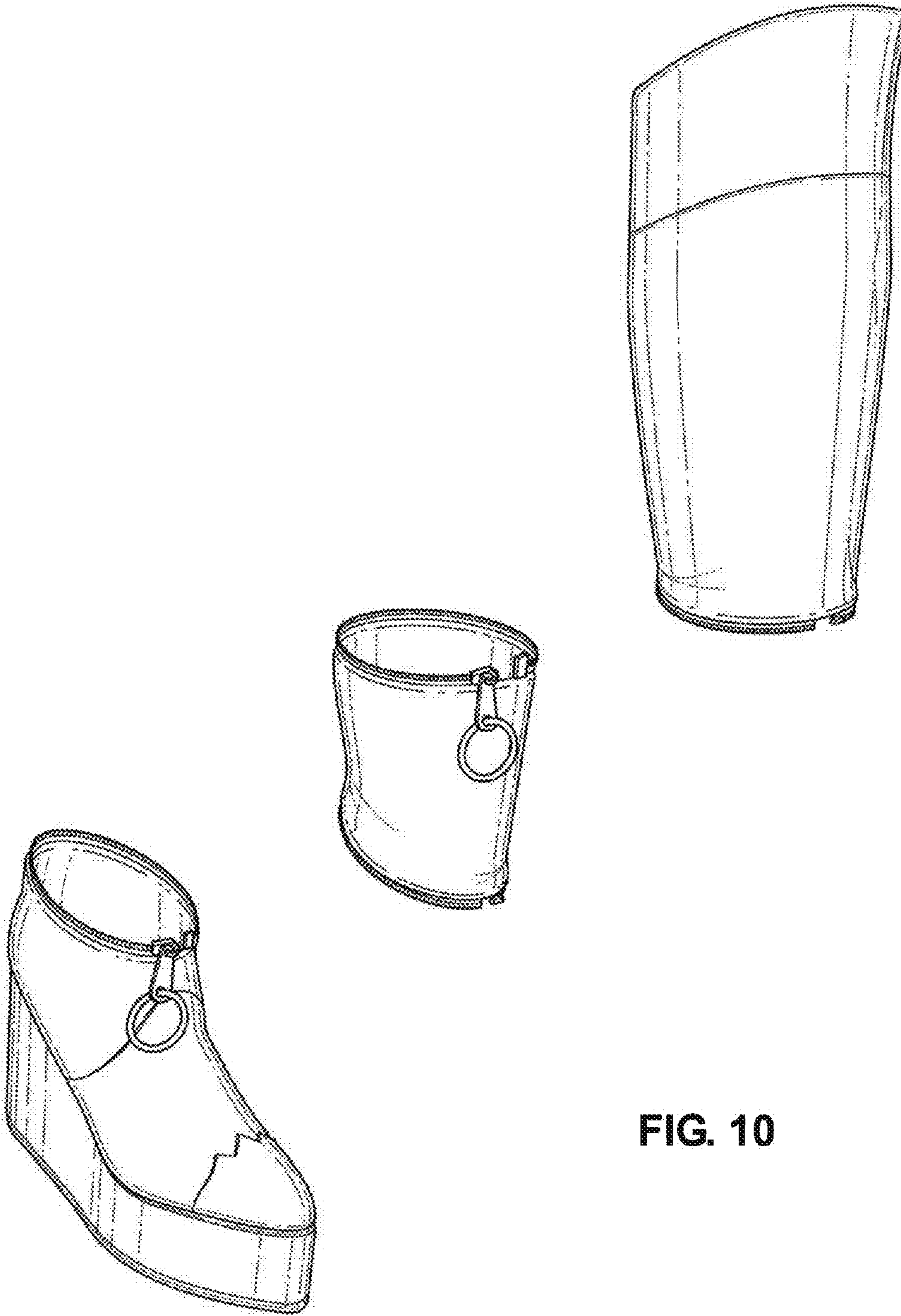

FIG. 10



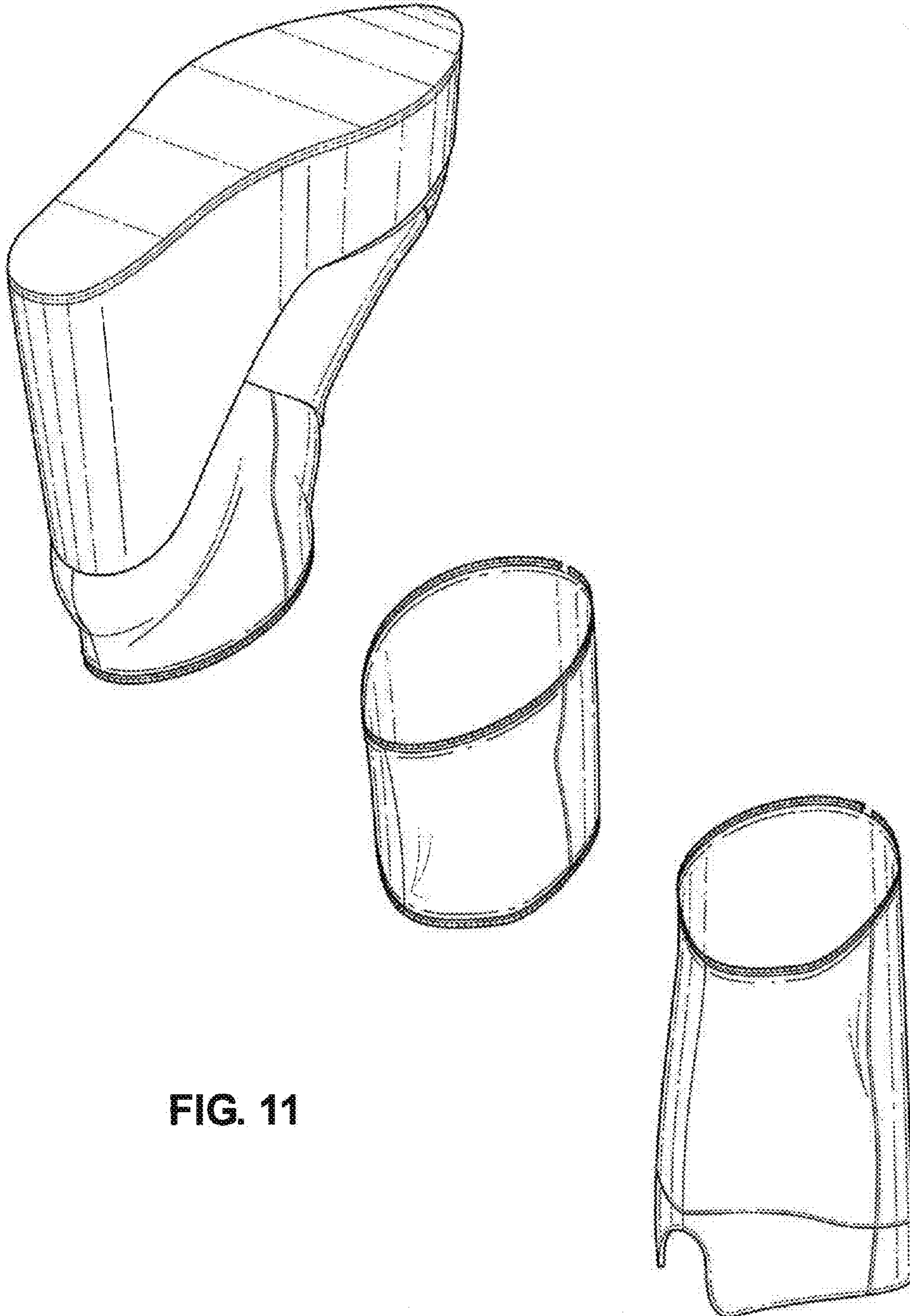

FIG. 11

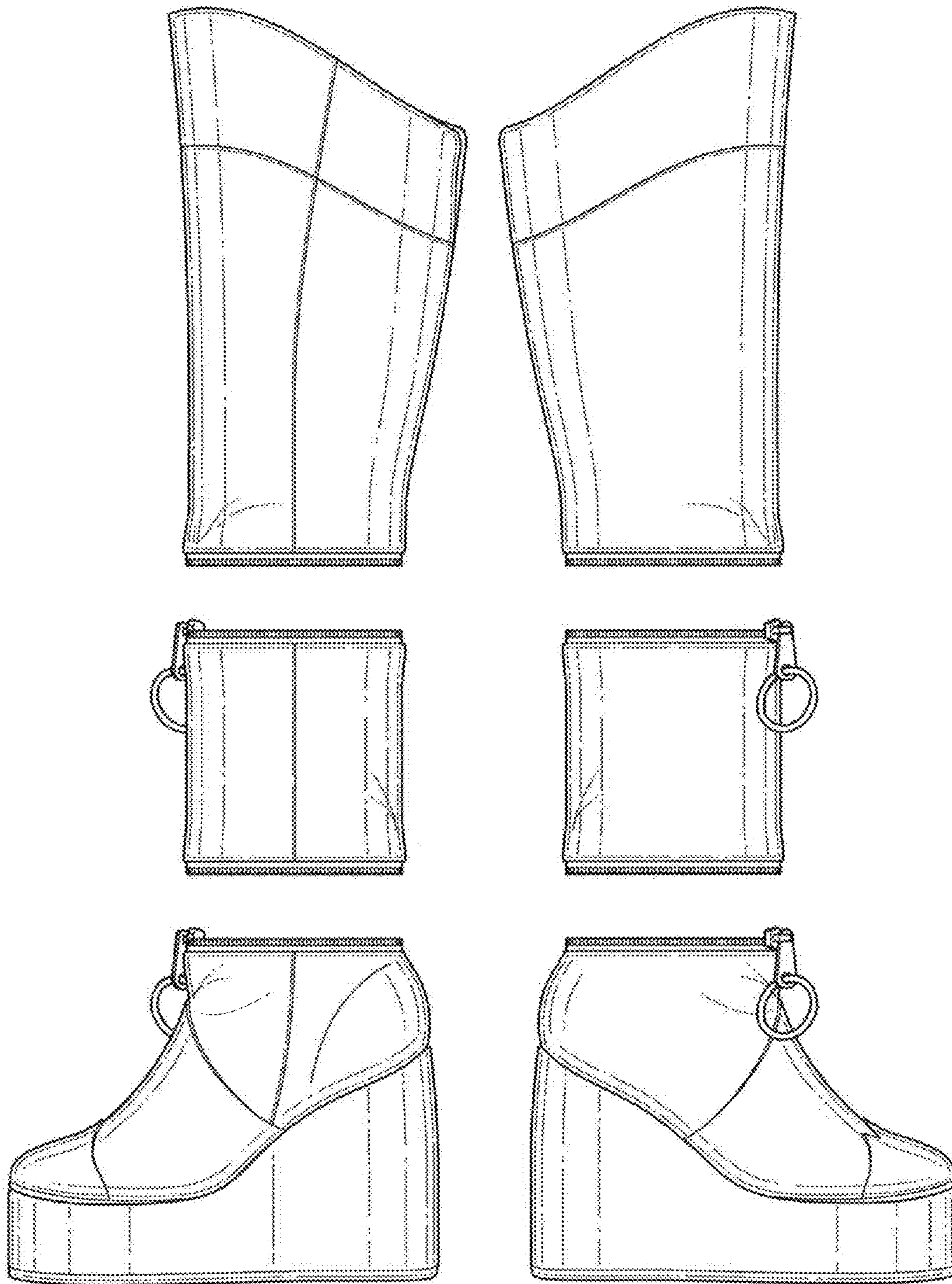

FIG. 12

FIG. 13

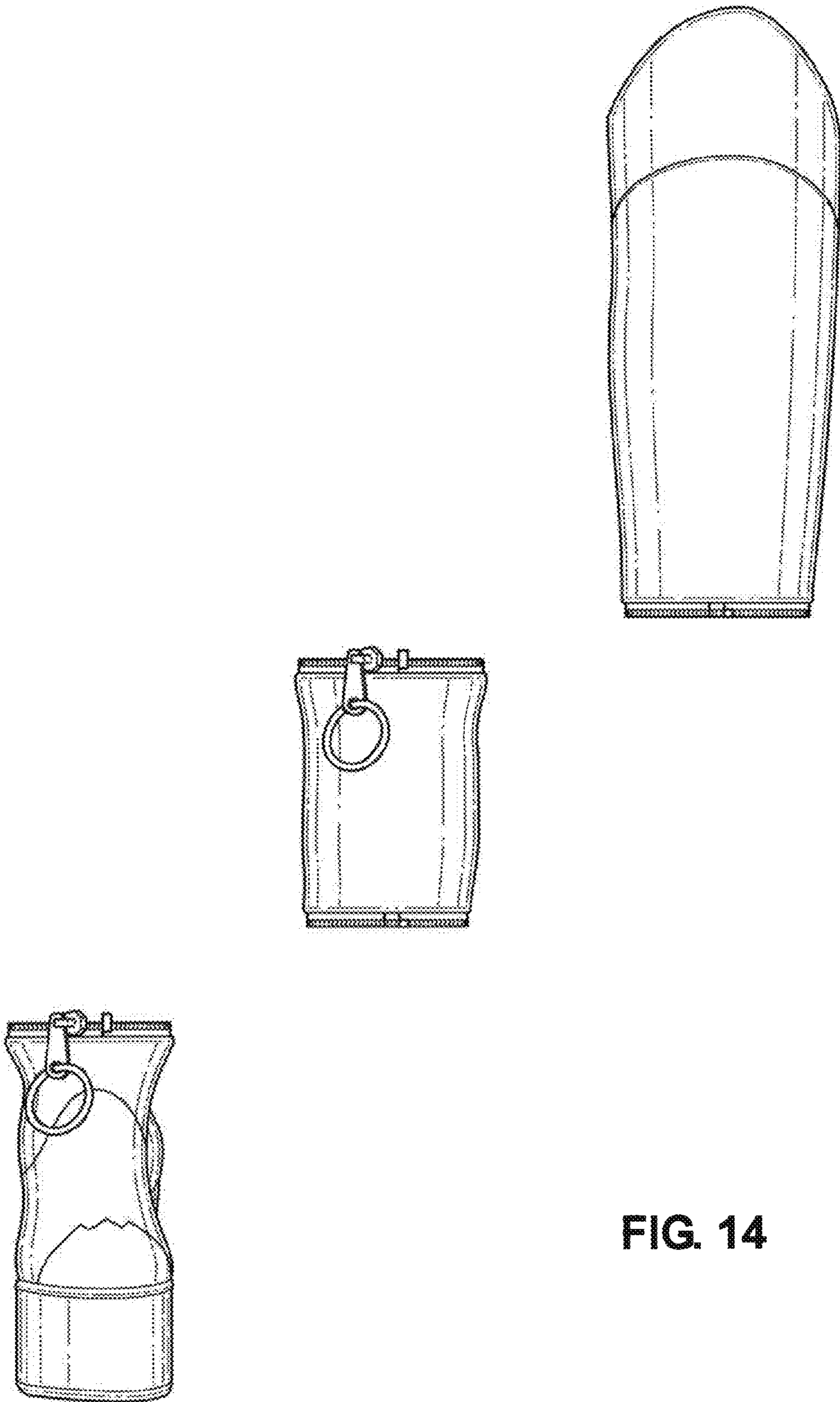
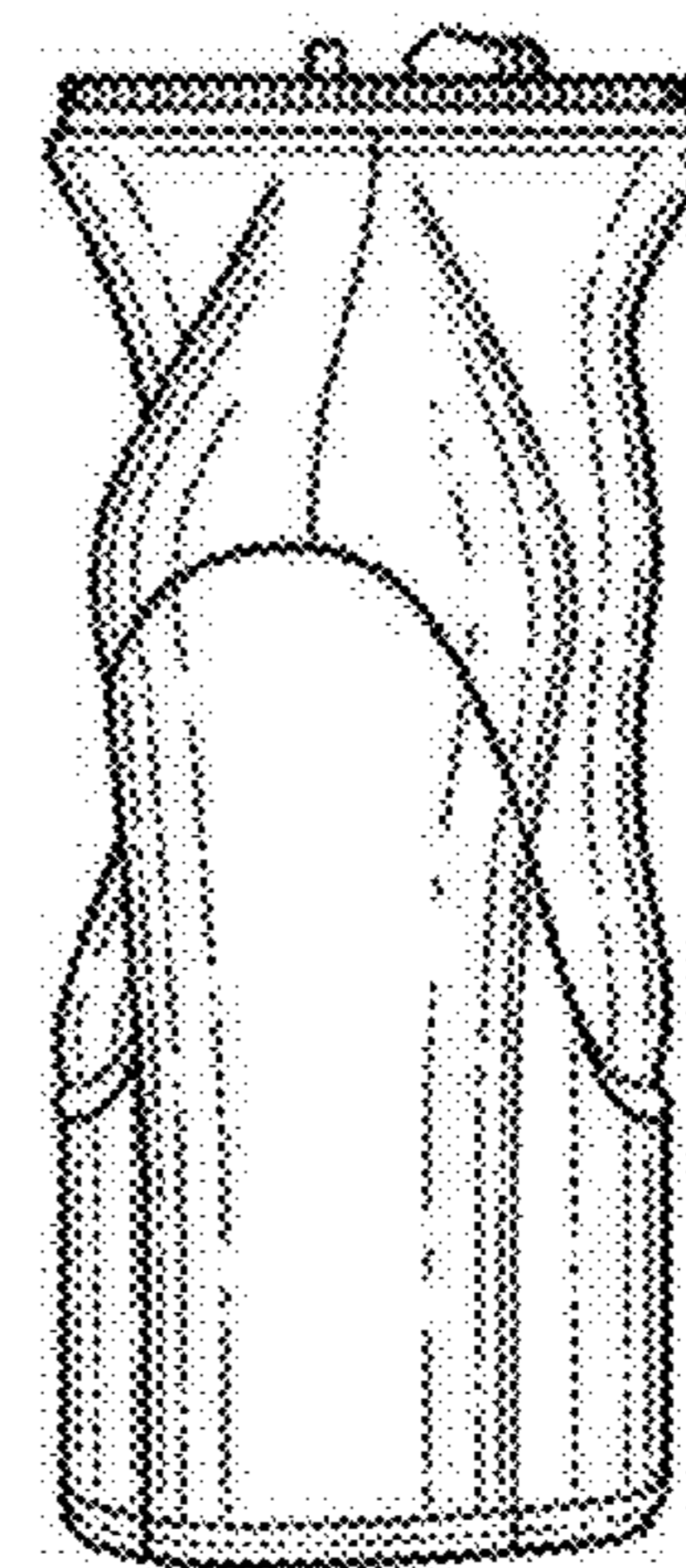
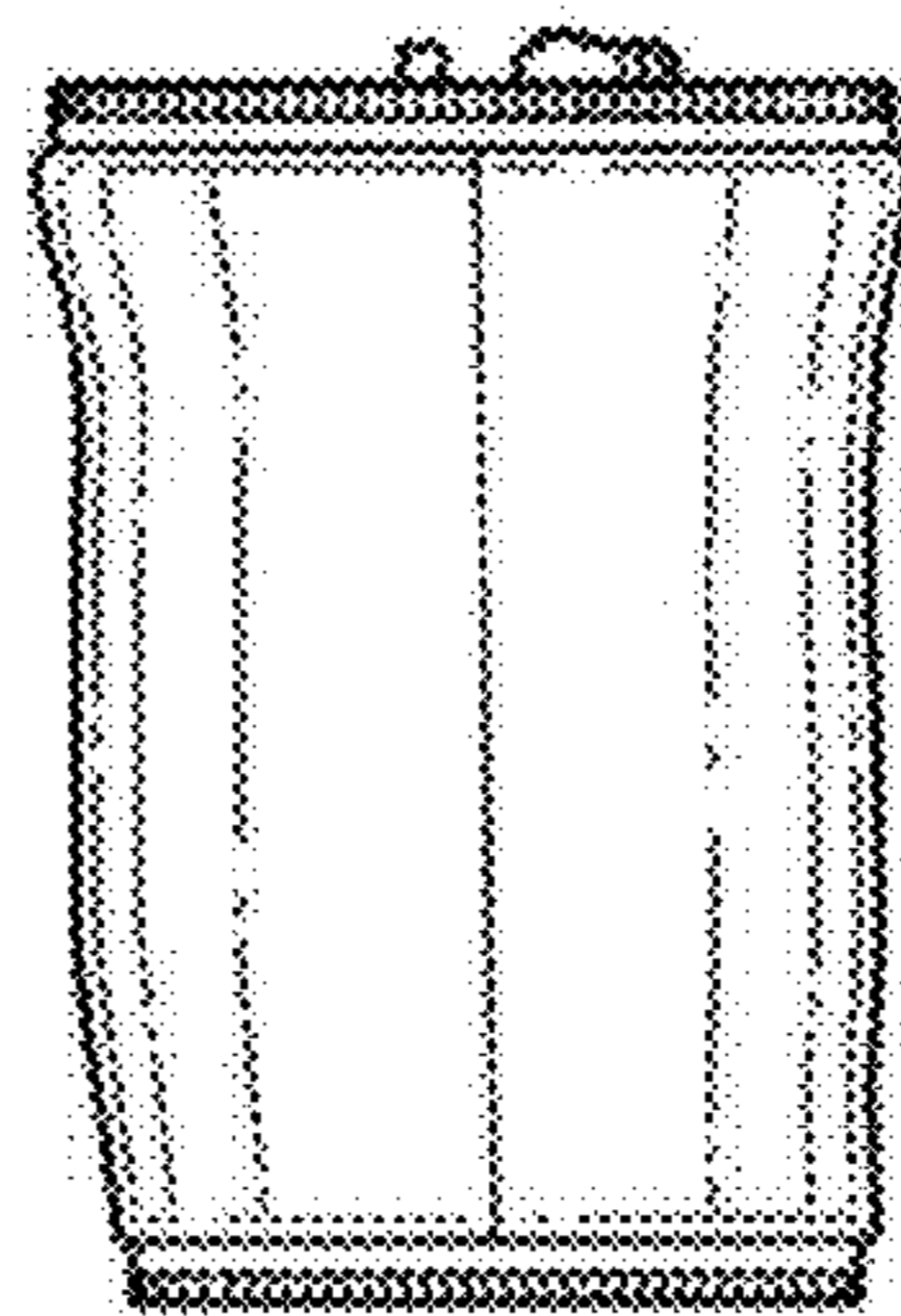
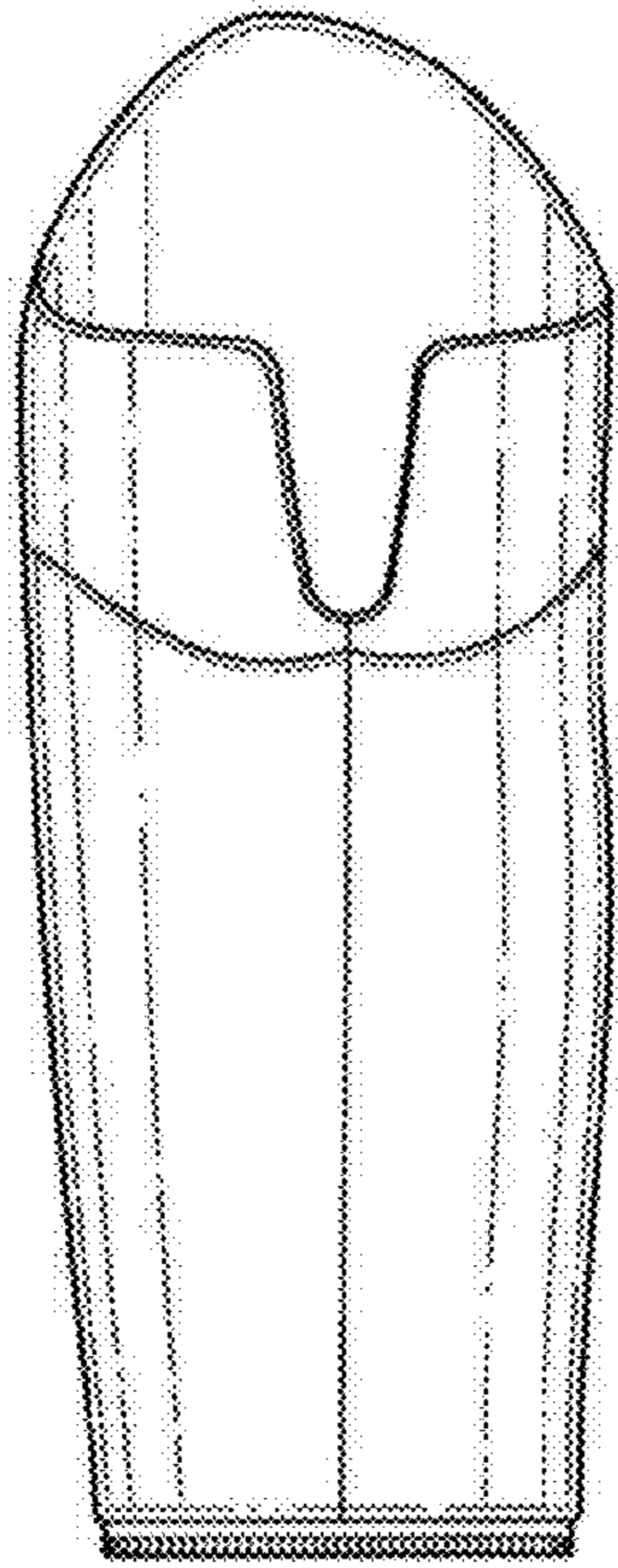

FIG. 14



**FIG. 15**

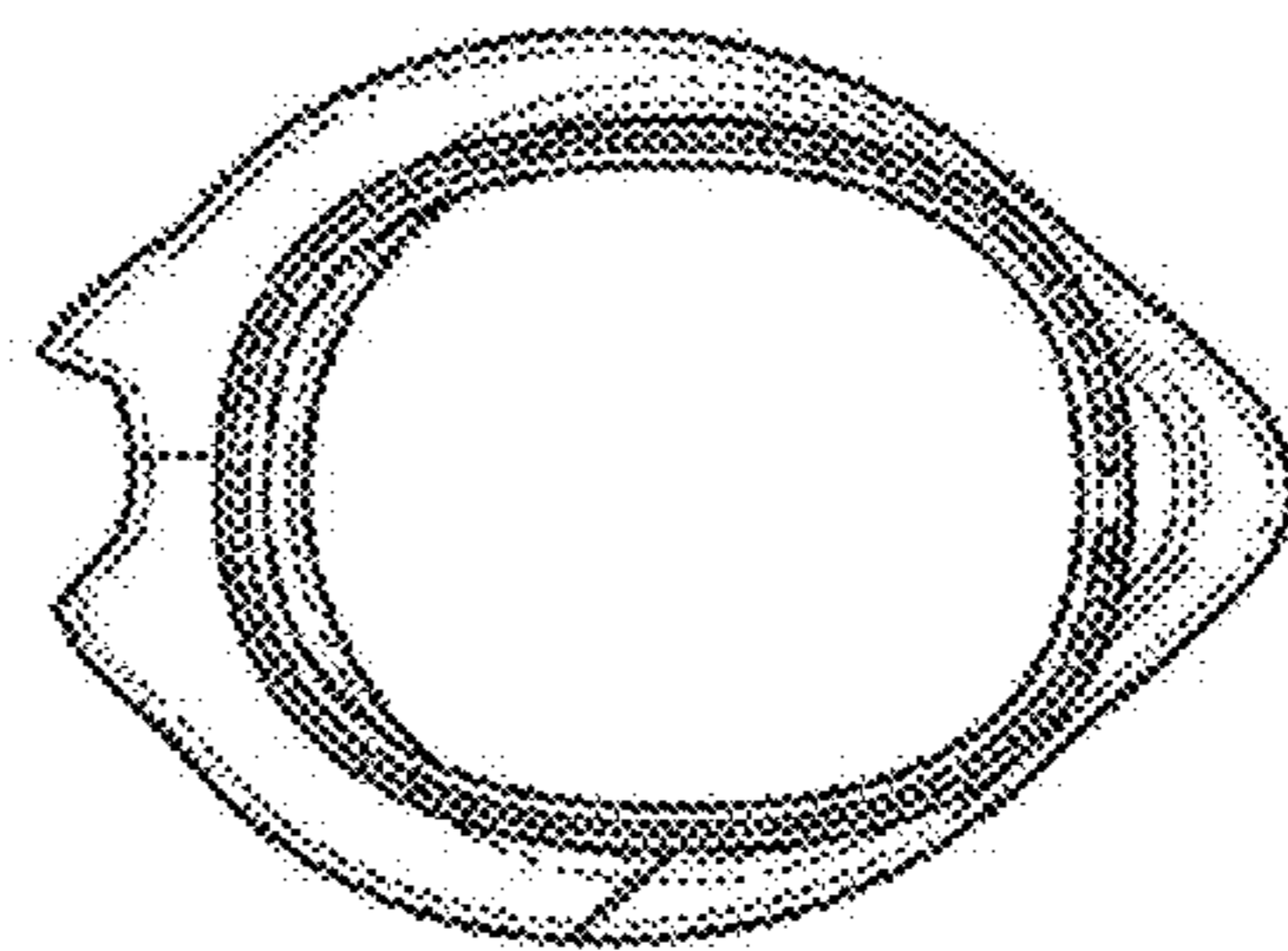
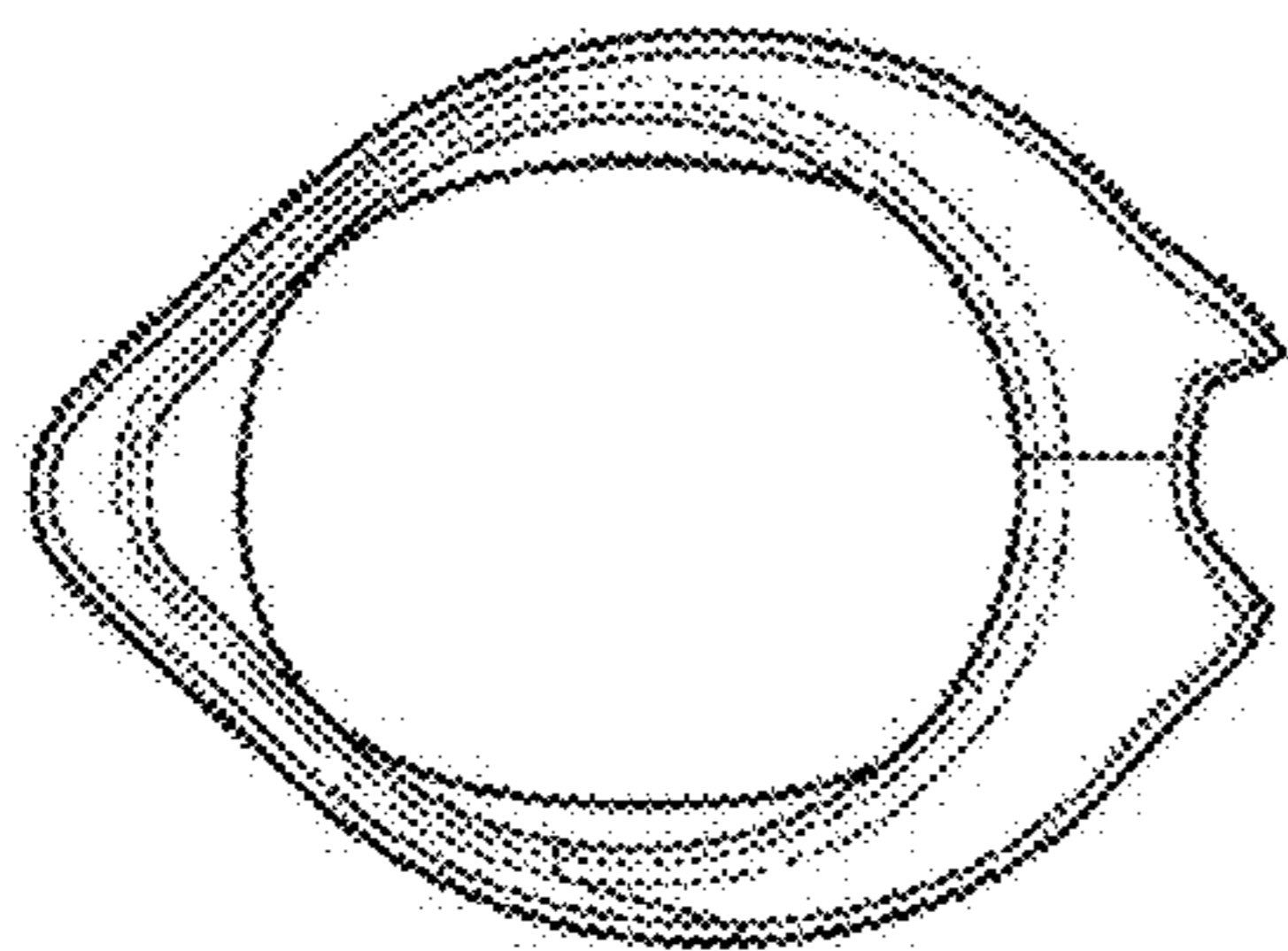
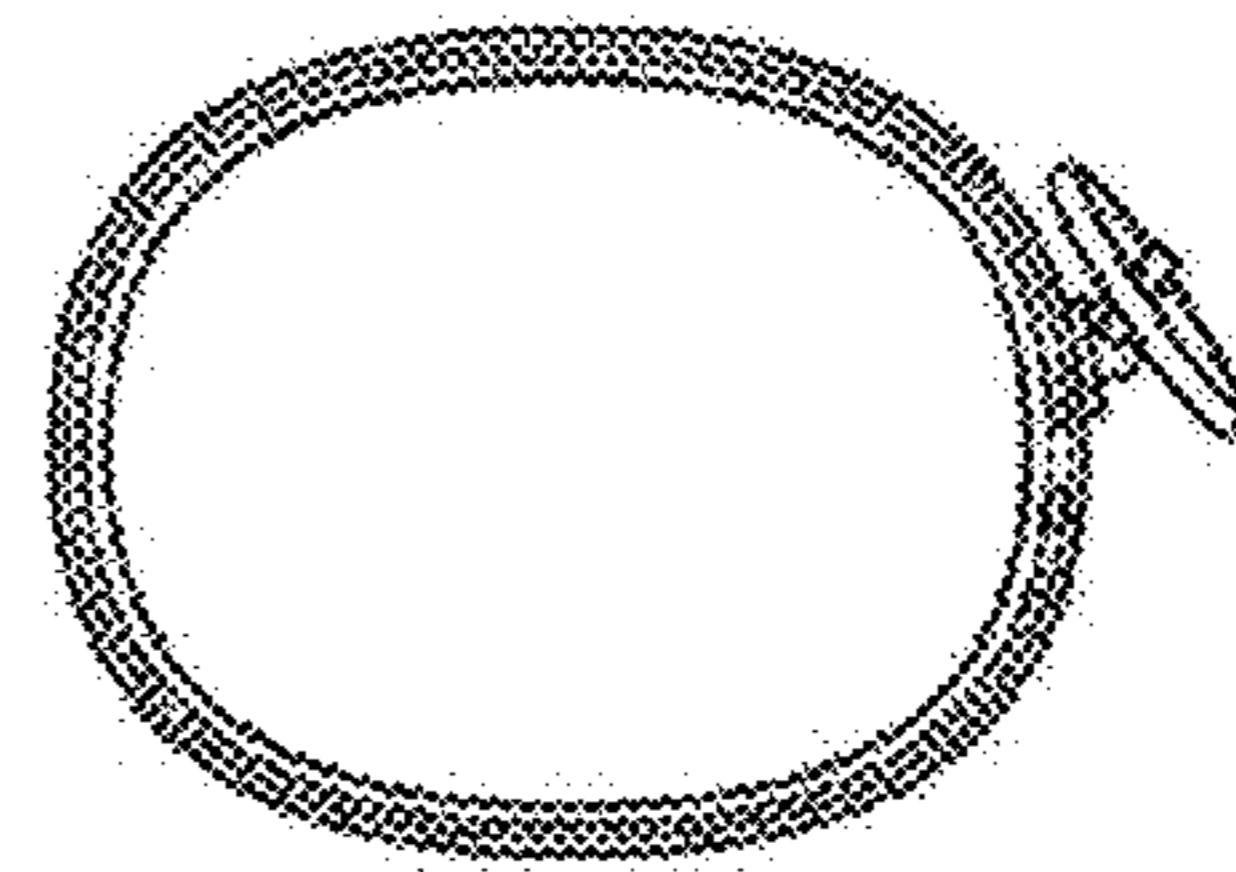
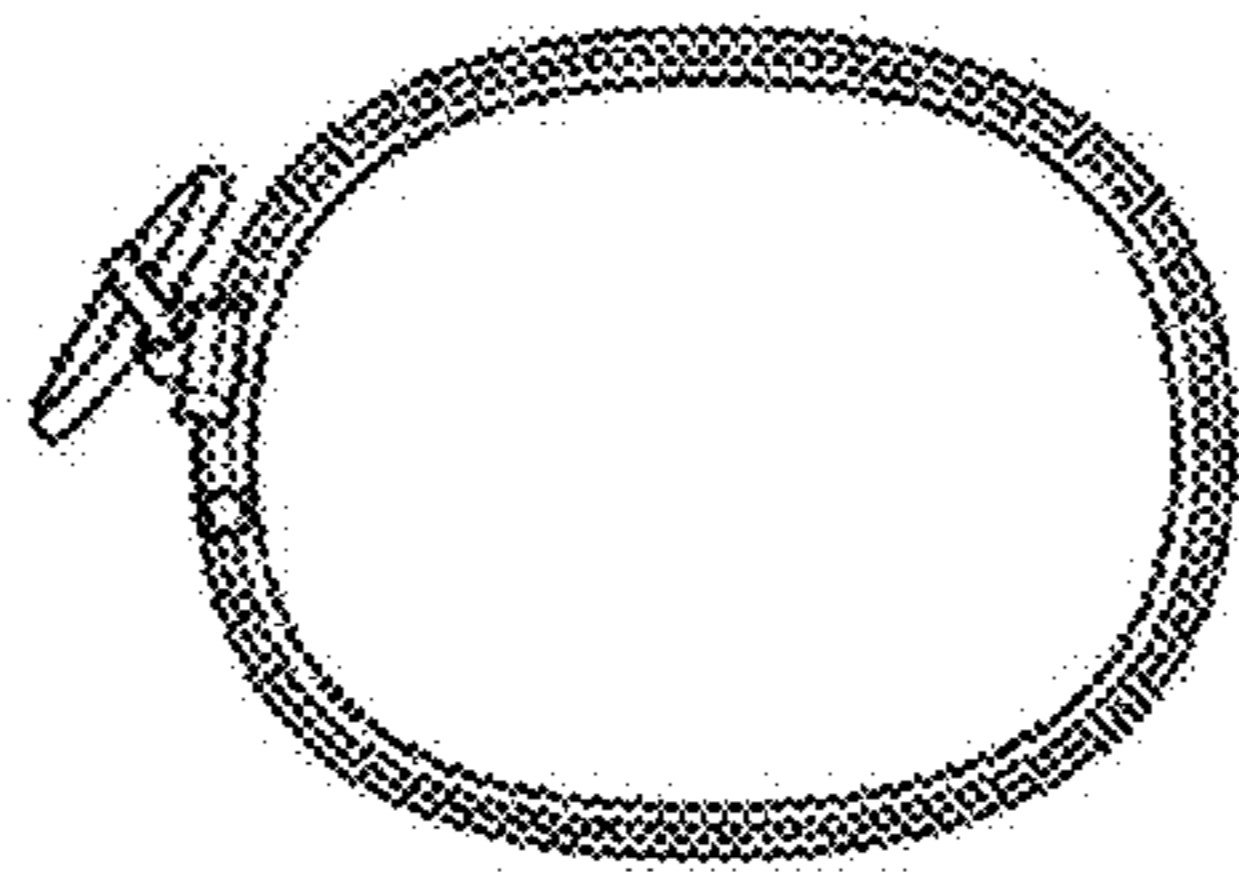
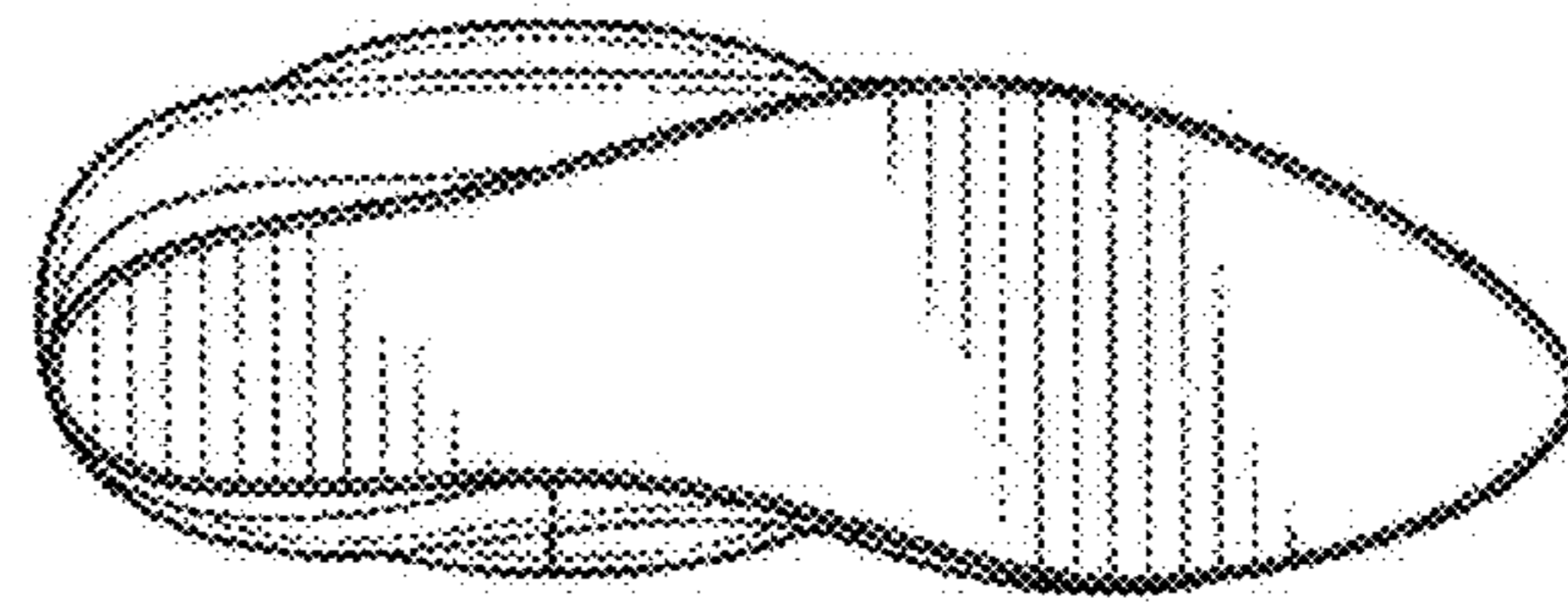
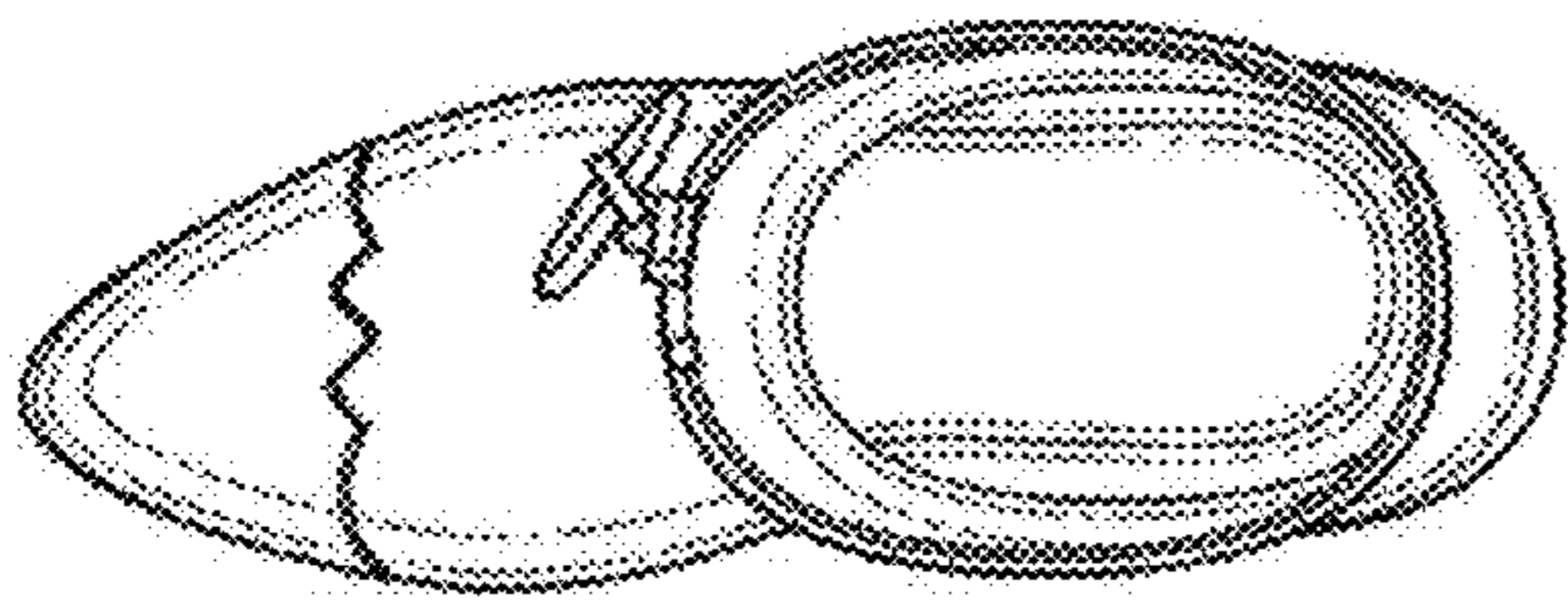

FIG. 16

FIG. 17