



US00D757357S

(12) **United States Design Patent**
Helfrich

(10) **Patent No.:** **US D757,357 S**

(45) **Date of Patent:** **** May 24, 2016**

(54) **SMOKING PIPE BOWL HAVING
MAGNETICALLY ATTACHED LID**

(71) Applicant: **Michael T. Helfrich**, Westminster, CO
(US)

(72) Inventor: **Michael T. Helfrich**, Westminster, CO
(US)

(73) Assignee: **TMFM LLC**, Denver, CO (US)

(**) Term: **14 Years**

(21) Appl. No.: **29/489,352**

(22) Filed: **Apr. 29, 2014**

(51) **LOC (10) Cl.** **27-02**

(52) **U.S. Cl.**
USPC **D27/167**

(58) **Field of Classification Search**
USPC D27/169, 162, 163, 167, 168, 194;
131/172, 176, 177, 180, 193, 220, 226,
131/329, 338; D23/229
CPC A24F 5/00; A24F 5/10
See application file for complete search history.

(56) **References Cited**

U.S. PATENT DOCUMENTS

2,111,588 A * 3/1938 Hirsch A24F 1/32
131/176
3,053,260 A * 9/1962 Koenigsamen A24F 5/10
131/177

(Continued)

OTHER PUBLICATIONS

Journey2 Smoky Mirror—WickiePipe—web page dated Jul. 25,
2013 from www.wickiepipe.com/Journey2.

(Continued)

Primary Examiner — Susan Bennett Hattan

Assistant Examiner — Rebecca Tsehaye

(74) *Attorney, Agent, or Firm* — Colorado Patents

(57) **CLAIM**

The ornamental design for my smoking pipe bowl having magnetically attached lid, as shown and described.

DESCRIPTION

FIG. 1 is a perspective view of the first embodiment of my new design for a smoking pipe bowl having magnetically attached lid in which the claimed design is shown as it would appear when formed with the stem of a smoking pipe wherein the pipe stem is shown in broken lines and forms no part of the claimed design;

FIG. 2 is a left side view of the smoking pipe bowl having magnetically attached lid shown in FIG. 1 and wherein the right side view is the mirror image of the left side view;

FIG. 3 is a top plan view of the smoking pipe bowl having magnetically attached lid shown in FIG. 1;

FIG. 4 is a bottom plan view of the smoking pipe bowl having magnetically attached lid shown in FIG. 1;

FIG. 5 is a front view of the smoking pipe bowl having magnetically attached lid shown in FIG. 1;

FIG. 6 is a rear view of the smoking pipe bowl having magnetically attached lid shown in FIG. 1;

FIG. 7 is the perspective view of FIG. 1 showing the lid removed from the bowl;

FIG. 8 is a perspective view of the second embodiment of my new design for a smoking pipe bowl having magnetically attached lid in which the claimed design is shown as it would appear when formed with the stem of a smoking pipe wherein the pipe stem is shown in broken lines and forms no part of the claimed design;

FIG. 9 is a left side view of the smoking pipe bowl having magnetically attached lid shown in FIG. 8 and wherein the right side view is the mirror image of the left side view;

FIG. 10 is a top plan view of the smoking pipe bowl having magnetically attached lid shown in FIG. 8;

FIG. 11 is a bottom plan view of the smoking pipe bowl having magnetically attached lid shown in FIG. 8;

FIG. 12 is a front view of the smoking pipe bowl having magnetically attached lid shown in FIG. 8;

FIG. 13 is a rear view of the smoking pipe bowl having magnetically attached lid shown in FIG. 8; and,

FIG. 14 is the perspective view of FIG. 8 showing the lid removed from the bowl.

1 Claim, 4 Drawing Sheets

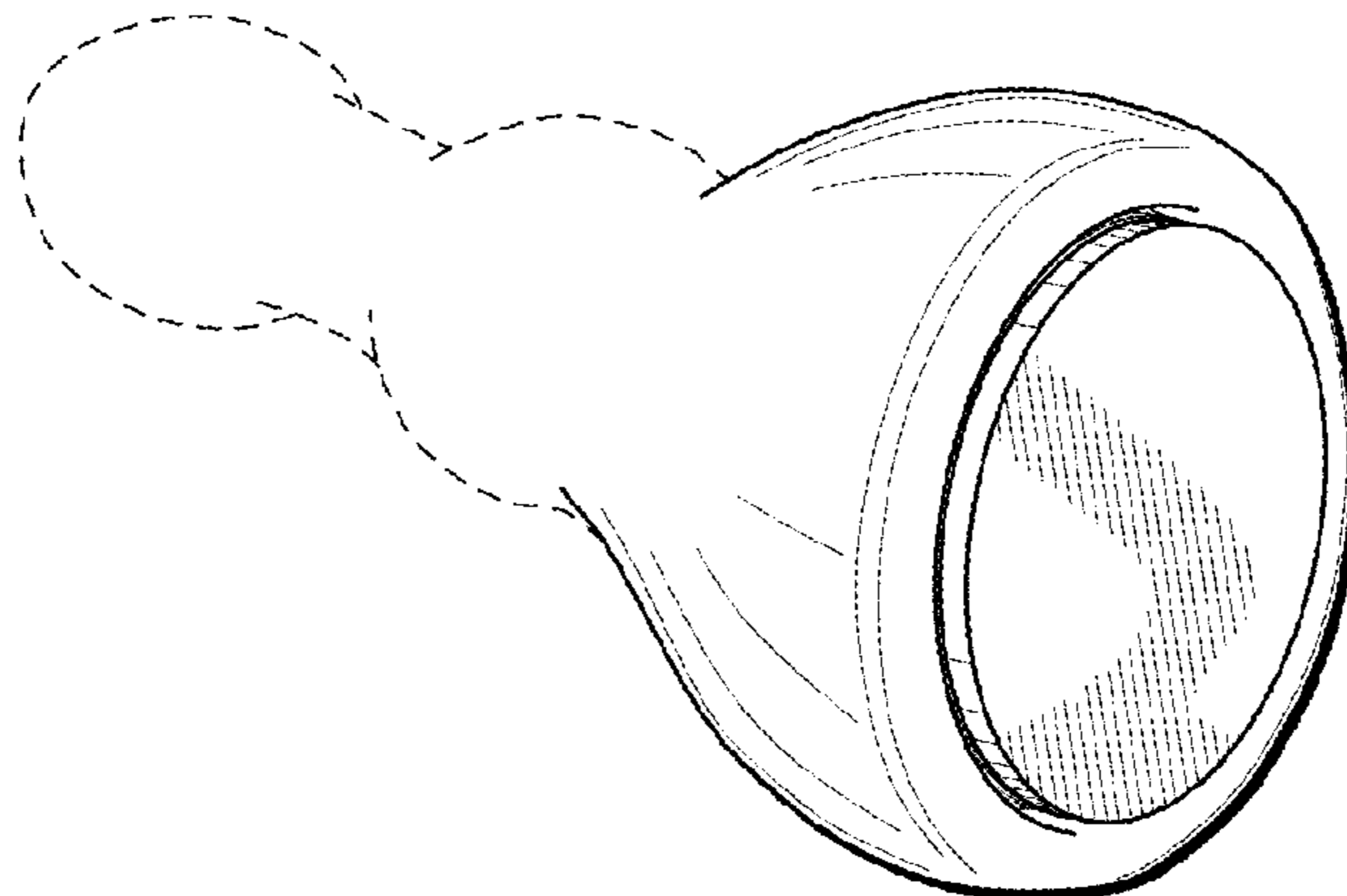

(56)

References Cited

U.S. PATENT DOCUMENTS

3,750,677 A * 8/1973 Jodoin A24F 5/00
131/181
D636,849 S * 4/2011 Yoo D23/213
D672,084 S * 12/2012 Ducey D27/137
D730,960 S * 6/2015 Shinozaki D15/126
D731,705 S * 6/2015 Nadeem D27/162

2012/0204888 A1* 8/2012 Descamp A24F 5/00
131/180
2015/0292186 A1* 10/2015 Kawamoto B05B 1/18
239/315

OTHER PUBLICATIONS

Gandalf Pipes—WickiePipe—web page from web.archive.org of
wickiepipe.com website dated Dec. 2012.

* cited by examiner

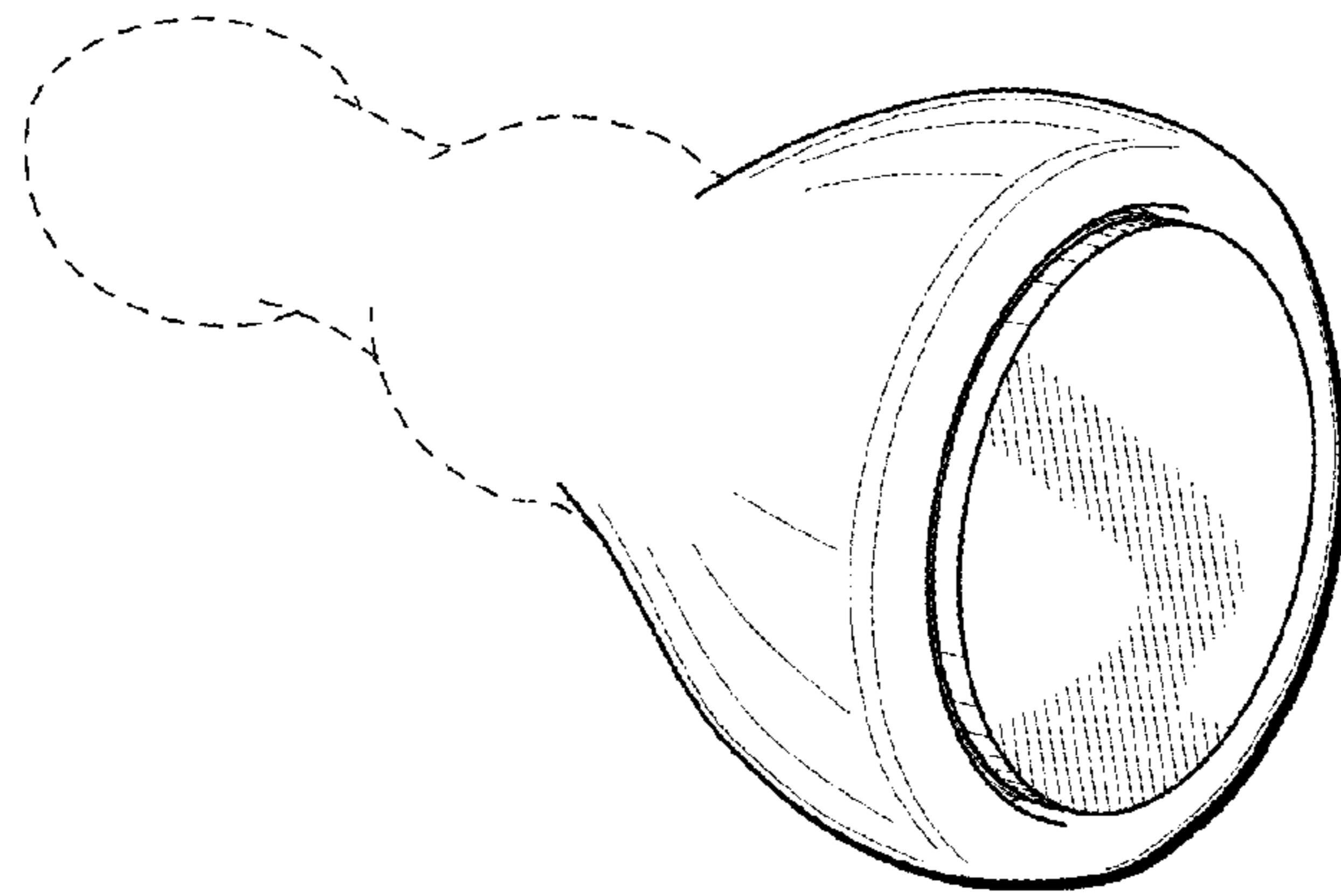

FIG. 1

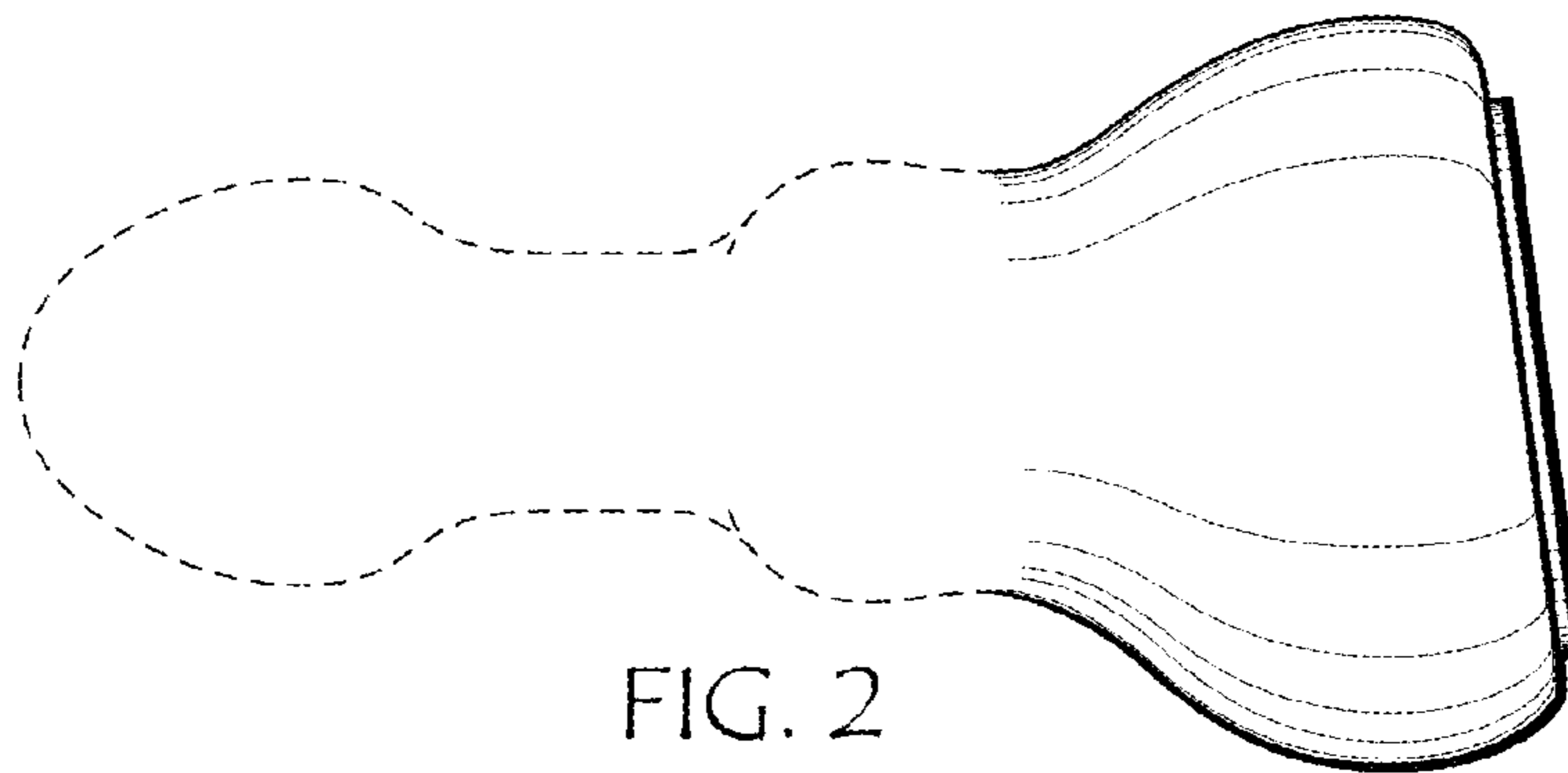

FIG. 2

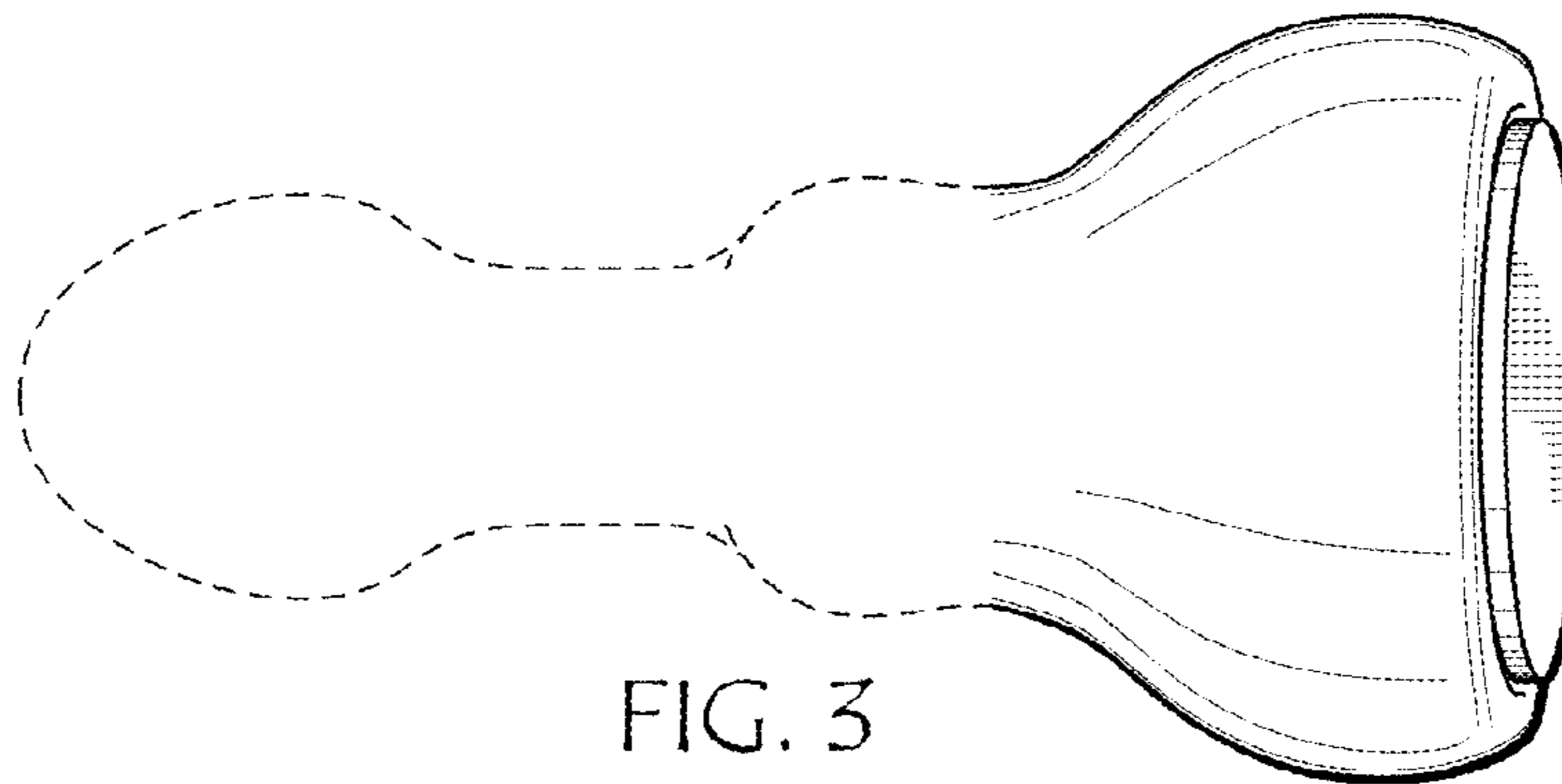

FIG. 3

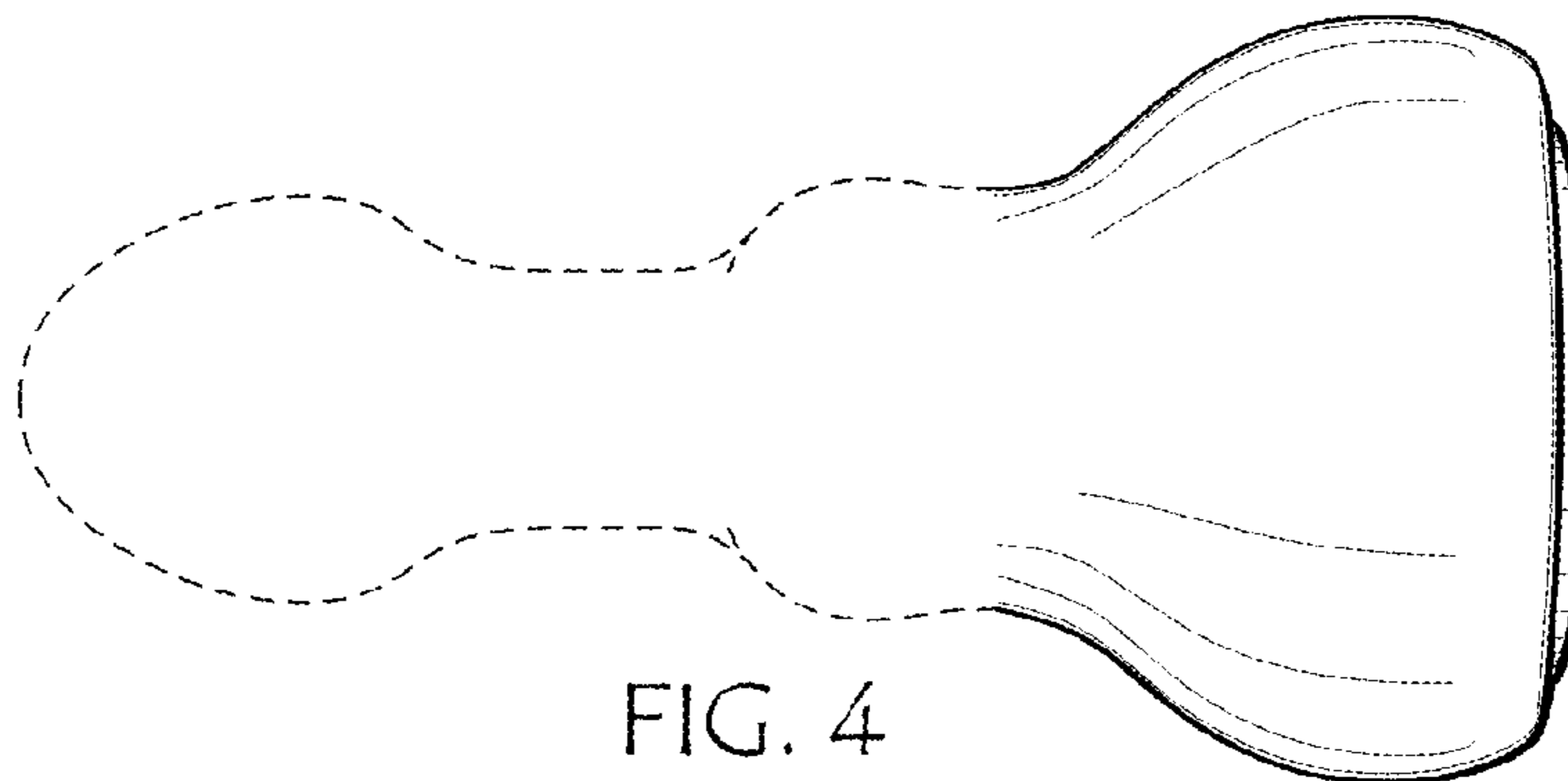

FIG. 4

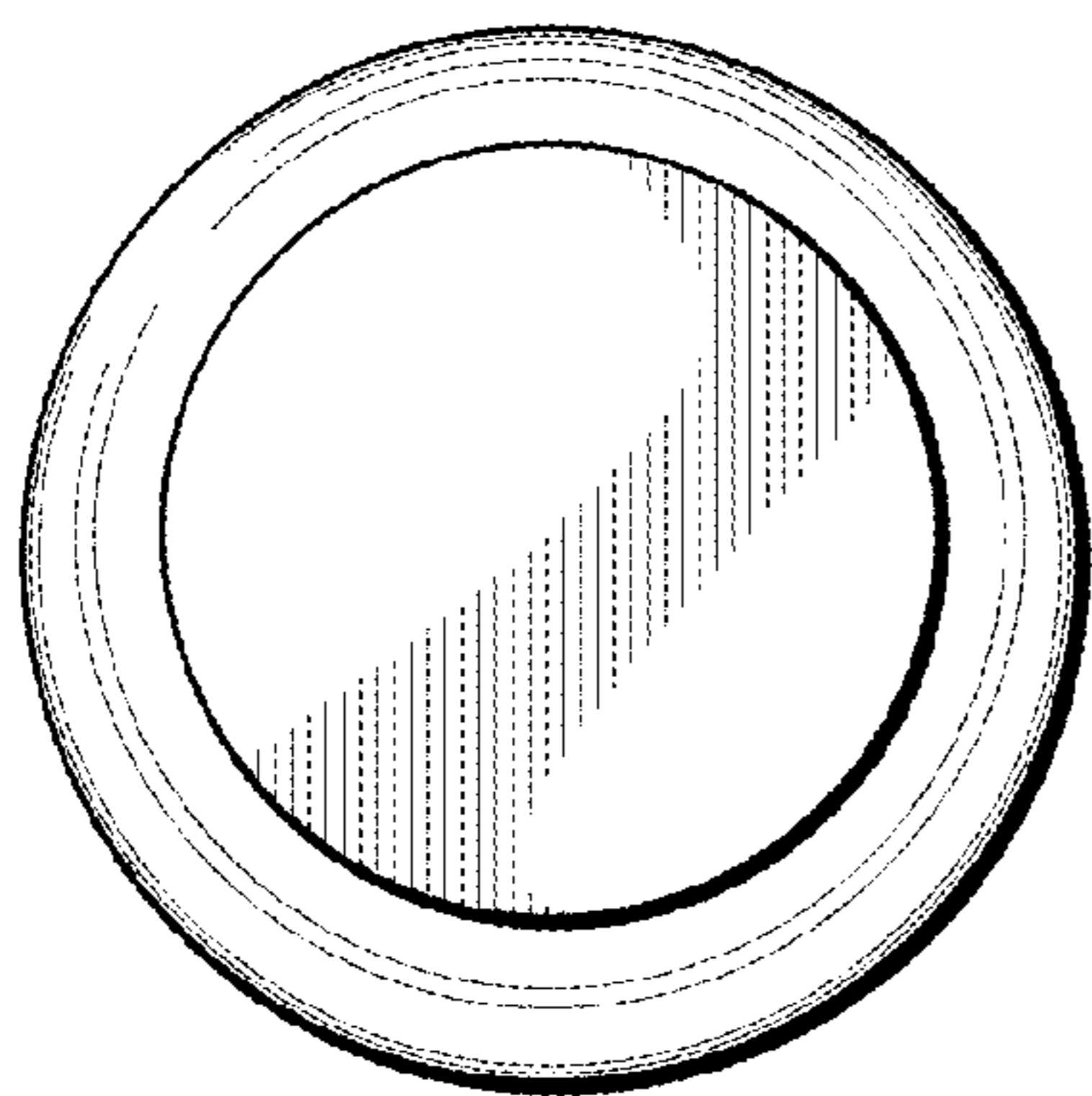

FIG. 5

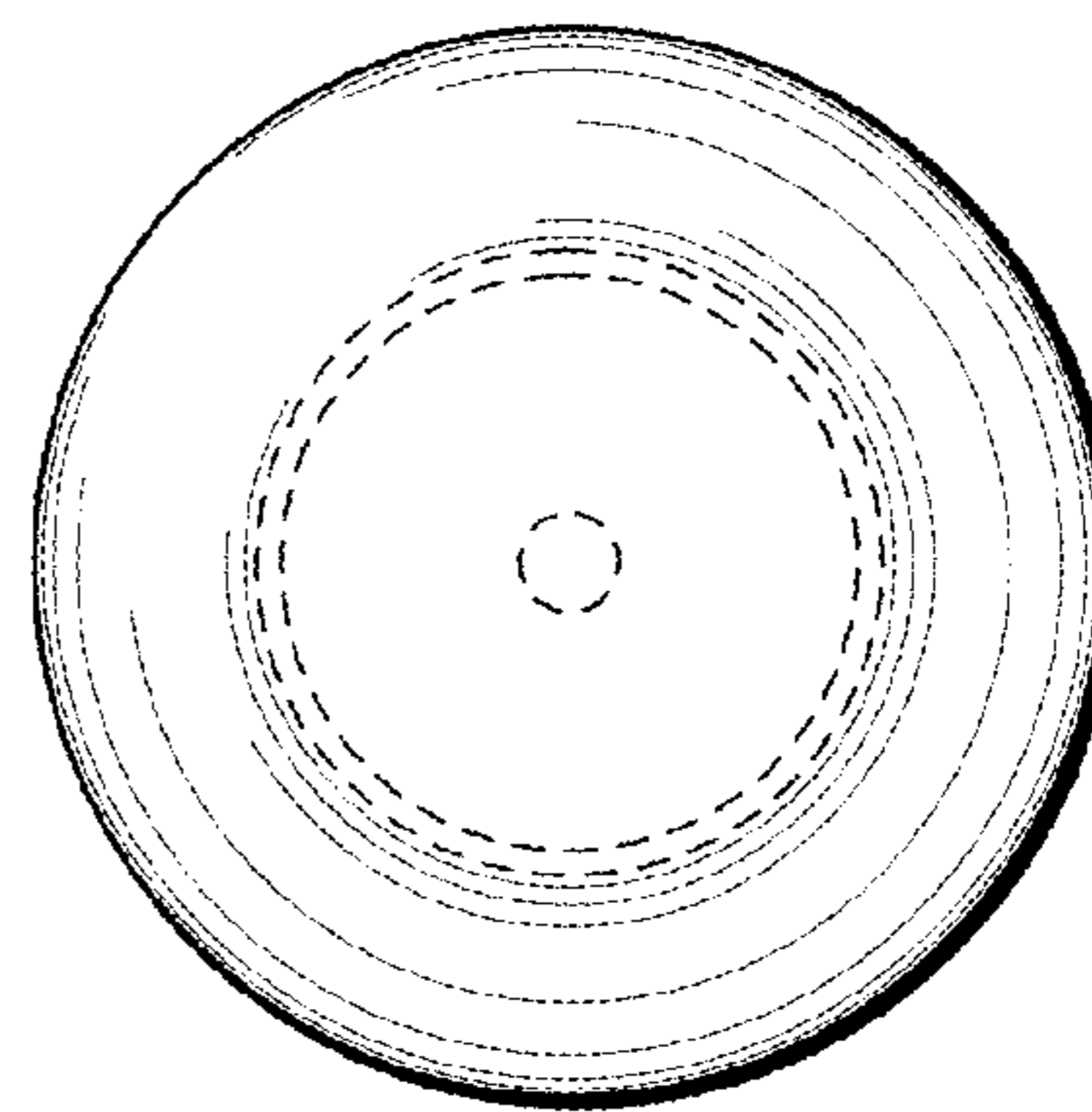

FIG. 6

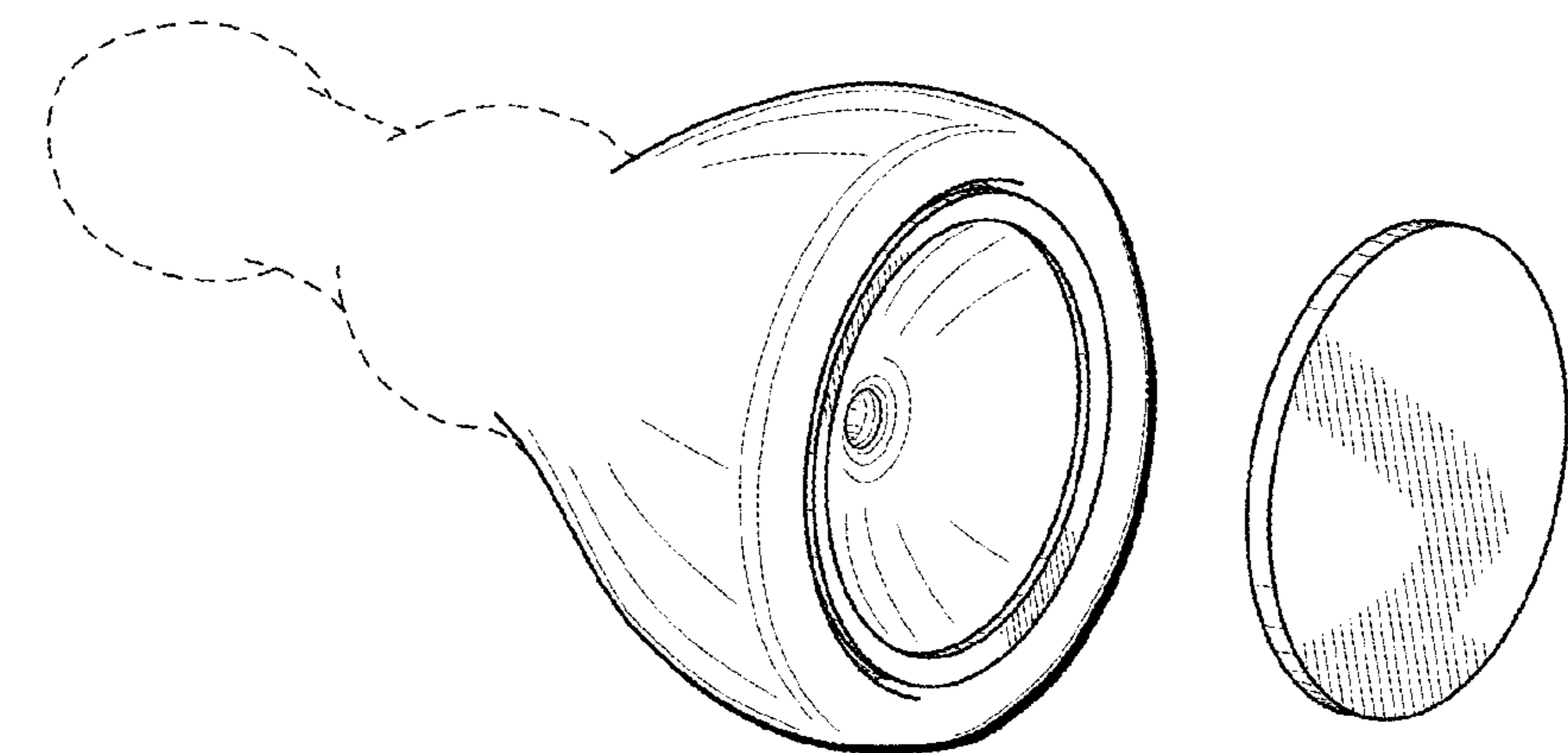

FIG. 7

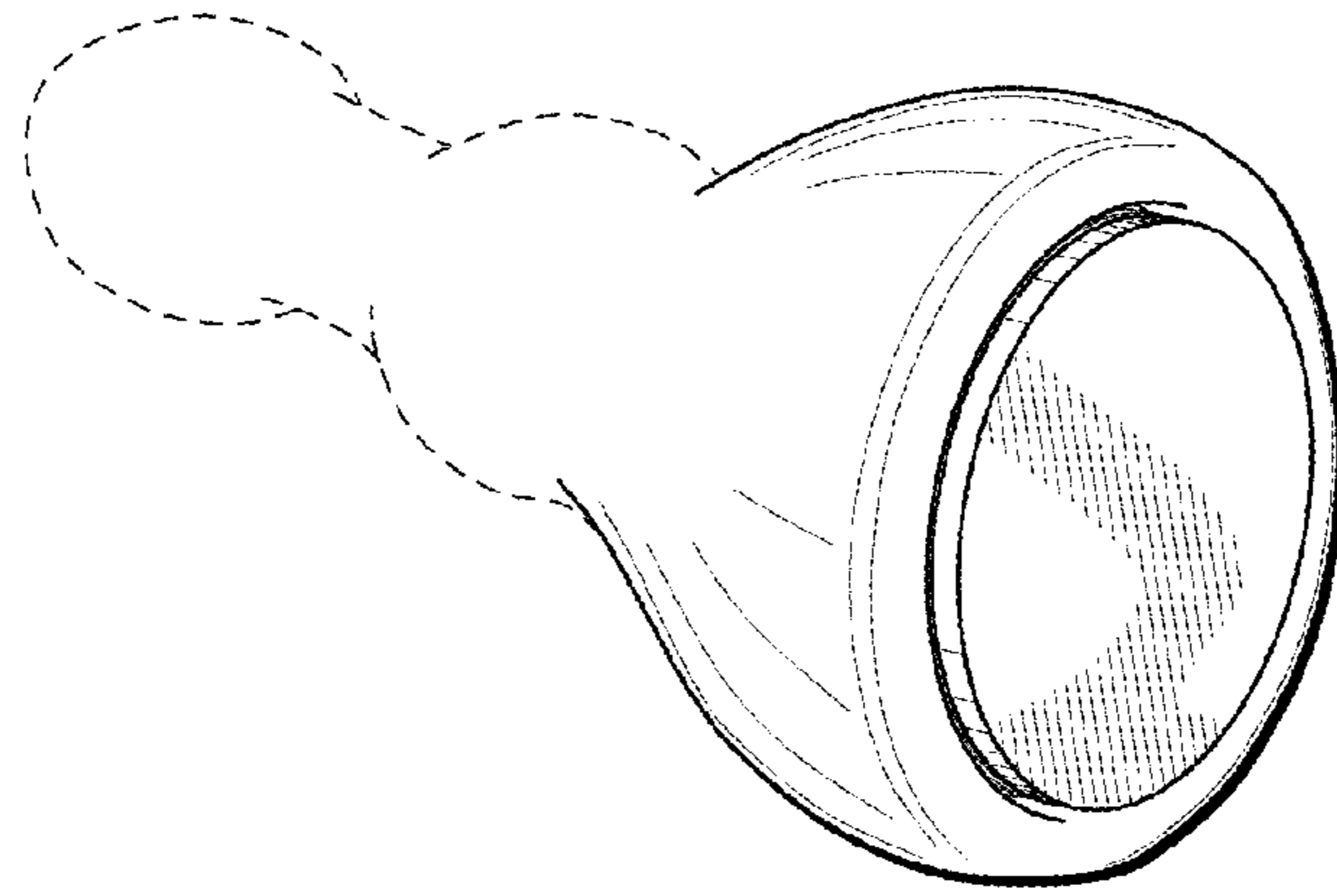

FIG. 8

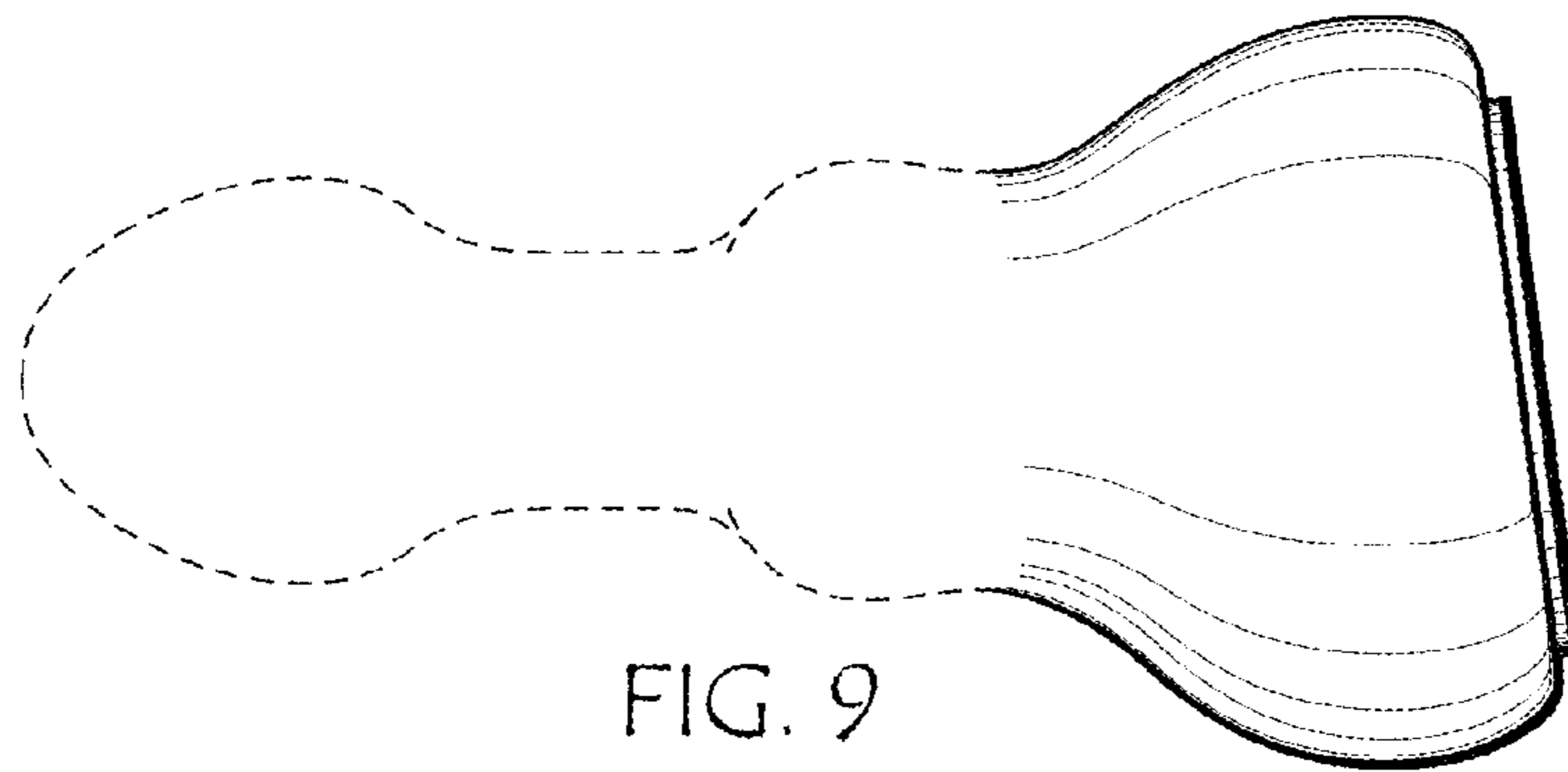

FIG. 9

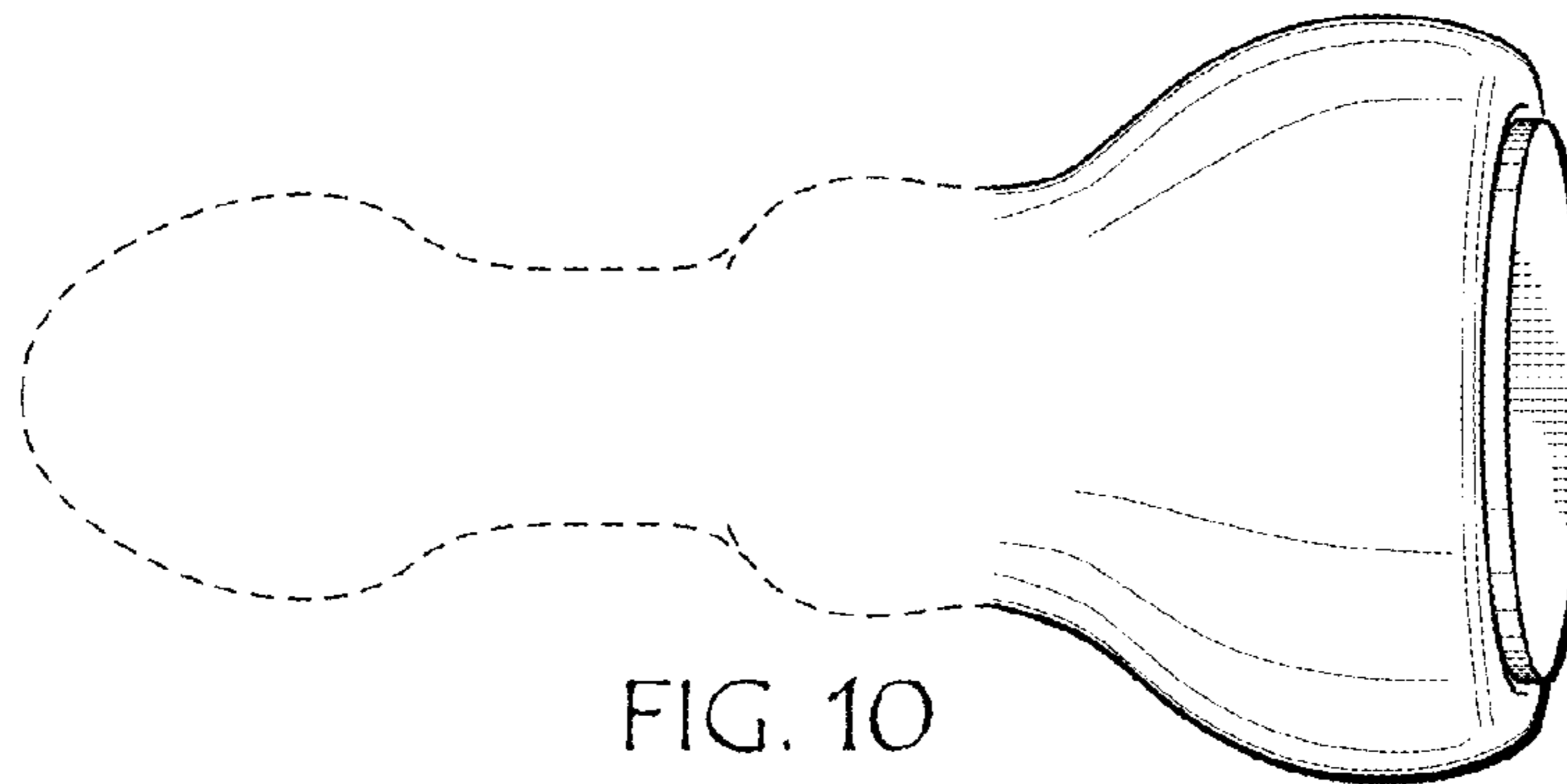

FIG. 10

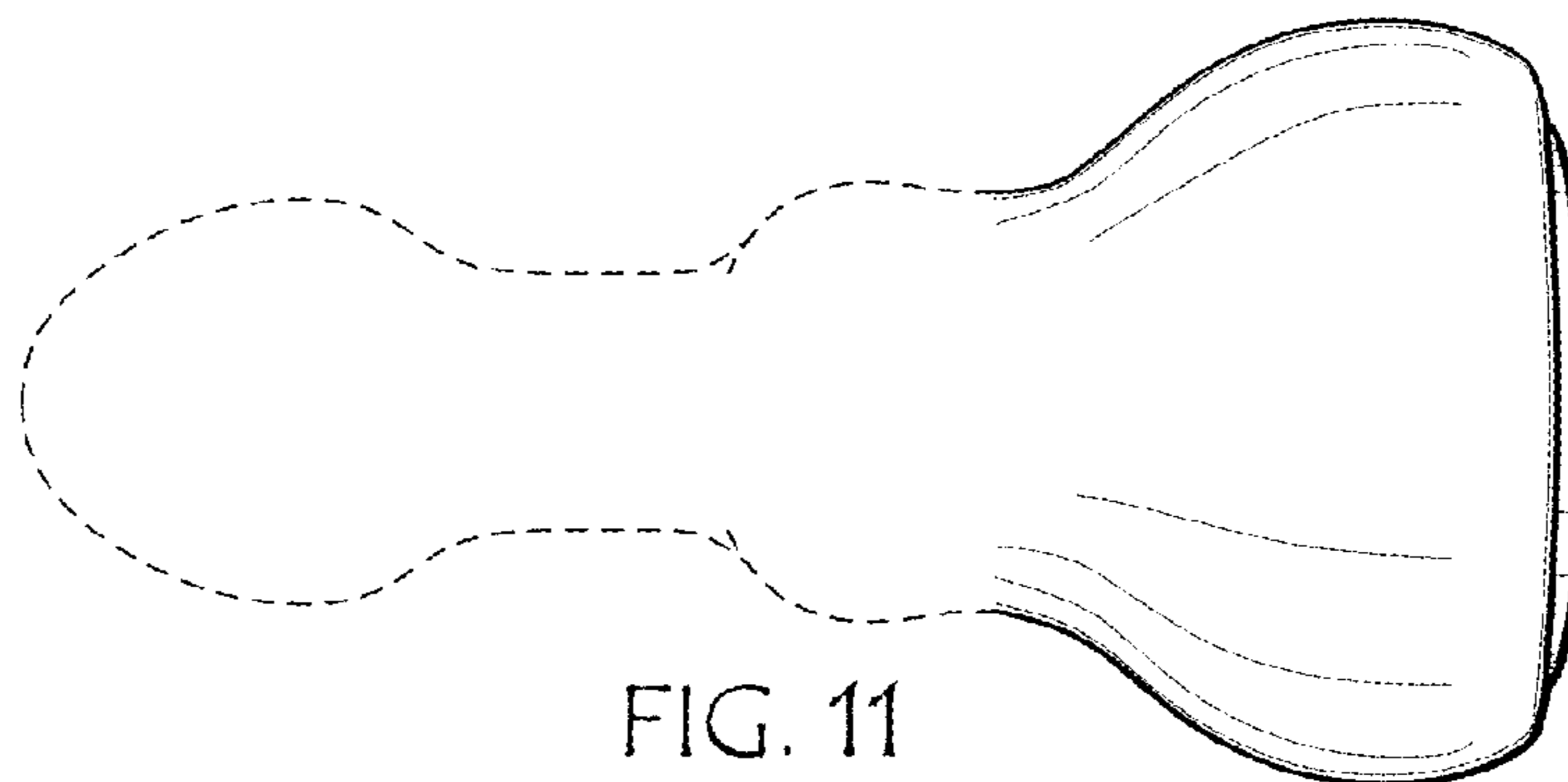

FIG. 11

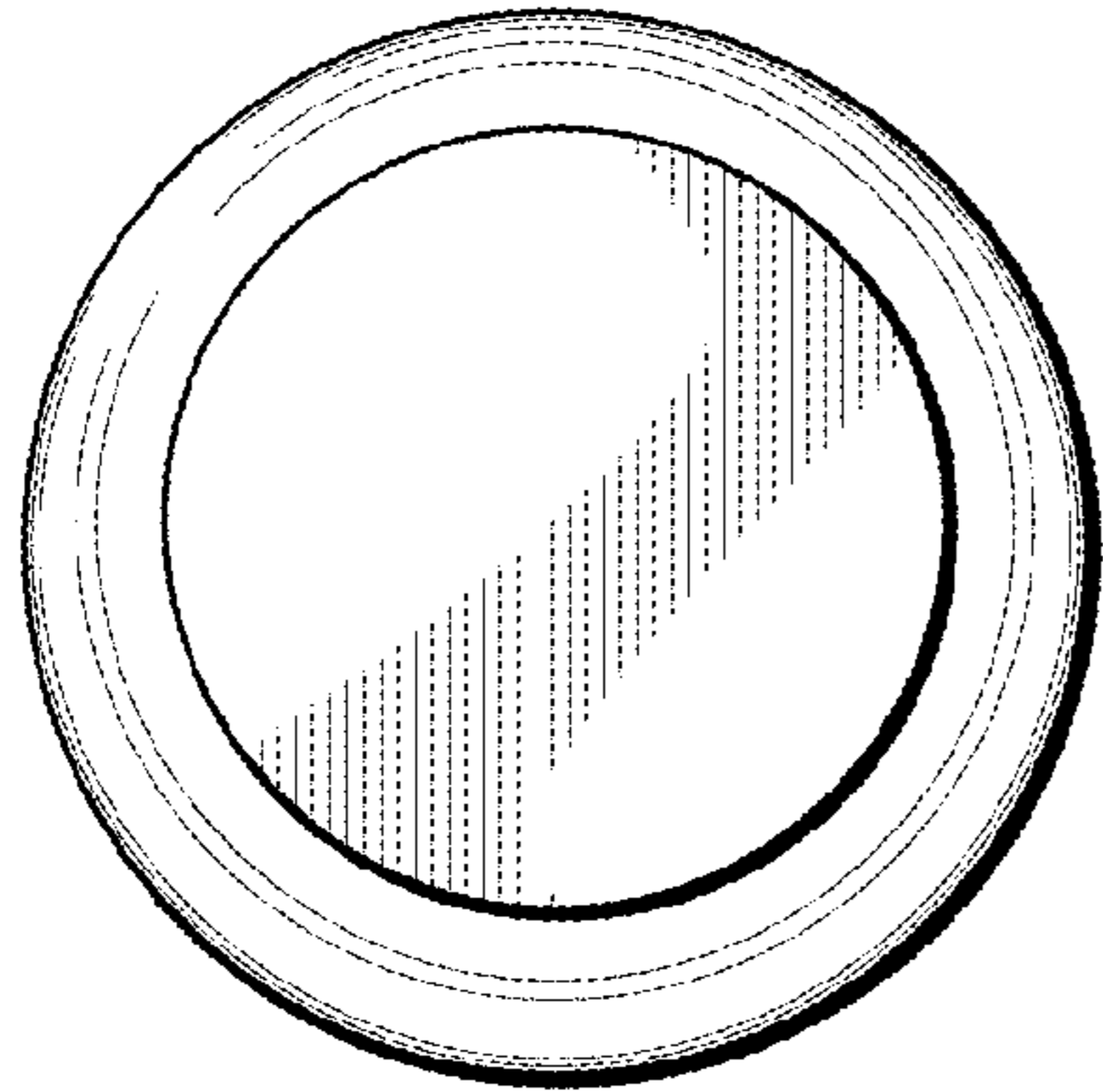

FIG. 12

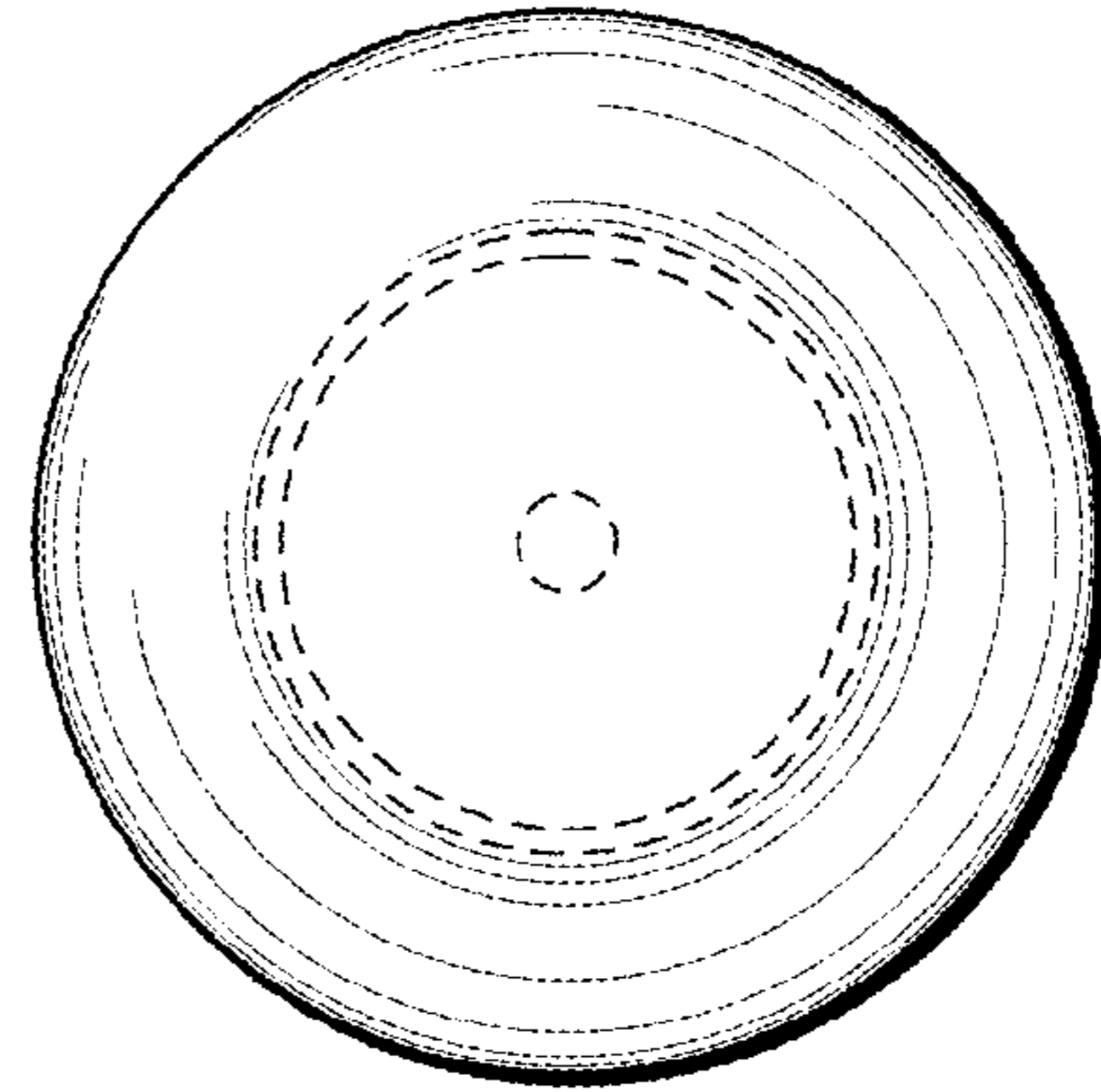

FIG. 13

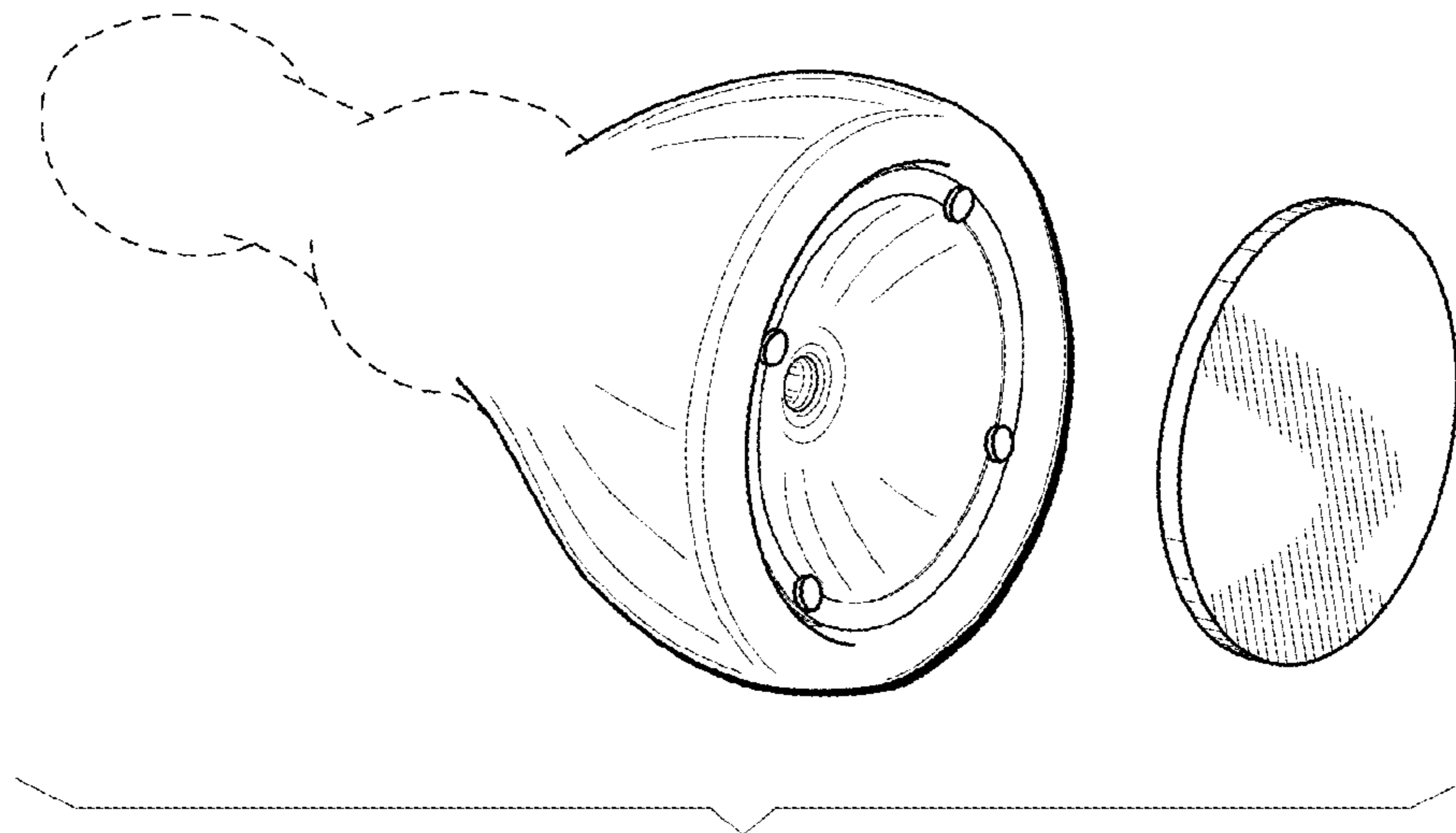

FIG. 14