



US00D757328S

(12) **United States Design Patent**  
**Anderson et al.**

(10) **Patent No.:** **US D757,328 S**  
(45) **Date of Patent:** **\*\* May 24, 2016**

(54) **LIGHTING FIXTURE**

(71) Applicant: **Apparatus LLC**, New York, NY (US)

(72) Inventors: **Jeremy R. Anderson**, Brooklyn, NY (US); **Gabriel Hendifar**, Brooklyn, NY (US)

(73) Assignee: **APPARATUS LLC**, New York, NY (US)

(\*\*) Term: **15 Years**

(21) Appl. No.: **29/527,195**

(22) Filed: **May 16, 2015**

(51) **LOC (10) Cl.** ..... **26-03**

(52) **U.S. Cl.**  
USPC ..... **D26/84; D26/86; D26/88**

(58) **Field of Classification Search**  
USPC ..... D26/80-91, 118, 152, 155  
CPC ..... F21S 8/03; F21S 8/033; F21S 8/036;  
F21S 8/04; F21S 8/043; F21S 8/046; F21S  
8/06; F21S 8/061; F21S 8/063; F21S 8/065;  
F21S 8/068; F21V 1/04; F21V 1/06; F21V  
1/12; F21V 3/02; F21V 3/023; F21V 5/06  
See application file for complete search history.

(56) **References Cited**

**U.S. PATENT DOCUMENTS**

1,686,571	A *	10/1928	Plaut	.....	F21S 8/06 362/247
2,601,554	A *	6/1952	Peters	.....	F21V 3/023 362/102
5,203,627	A *	4/1993	Kira	.....	F21V 15/01 362/285
D397,821	S *	9/1998	Palmarì	.....	D26/135
6,425,682	B1 *	7/2002	Klaus	.....	F21S 8/068 362/249.01
D502,280	S *	2/2005	Parres	.....	D26/80
D539,960	S *	4/2007	Hsu	.....	D26/81
D563,594	S *	3/2008	Held	.....	D26/110
D596,334	S *	7/2009	Sabernig	.....	D26/88
D596,335	S *	7/2009	Sabernig	.....	D26/88
D653,385	S *	1/2012	Parker	.....	D26/118
D709,637	S *	7/2014	Terzani	.....	D26/83

\* cited by examiner

*Primary Examiner* — Clare E Heflin

(74) *Attorney, Agent, or Firm* — Gottlieb, Rackman & Reisman P.C.

(57) **CLAIM**

We claim the ornamental design for a lighting fixture, as shown and described.

**DESCRIPTION**

FIG. 1 is a left elevation view showing a first embodiment of my new design of a lighting fixture;  
 FIG. 2 is a right elevation view of the lighting fixture of the first embodiment;  
 FIG. 3 is a front elevation view of the lighting fixture of the first embodiment;  
 FIG. 4 is a rear elevation view of the lighting fixture of the first embodiment;  
 FIG. 5 is a top plan view of the lighting fixture of the first embodiment;  
 FIG. 6 is a bottom view of the lighting fixture of the first embodiment;  
 FIG. 7 is a perspective view of the lighting fixture of the first embodiment;  
 FIG. 8 is a left elevation view showing a second embodiment of my new design of a lighting fixture;  
 FIG. 9 is a right elevation view of the lighting fixture of the second embodiment;  
 FIG. 10 is a front elevation view of the lighting fixture of the second embodiment;  
 FIG. 11 is a rear elevation view of the lighting fixture of the second embodiment;  
 FIG. 12 is a top plan view of the lighting fixture of the second embodiment;  
 FIG. 13 is a bottom view of the lighting fixture of the second embodiment;  
 FIG. 14 is a perspective view of the lighting fixture of the second embodiment;  
 FIG. 15 is a left elevation view showing a third embodiment of my new design of a lighting fixture;  
 FIG. 16 is a right elevation view of the lighting fixture of the third embodiment;

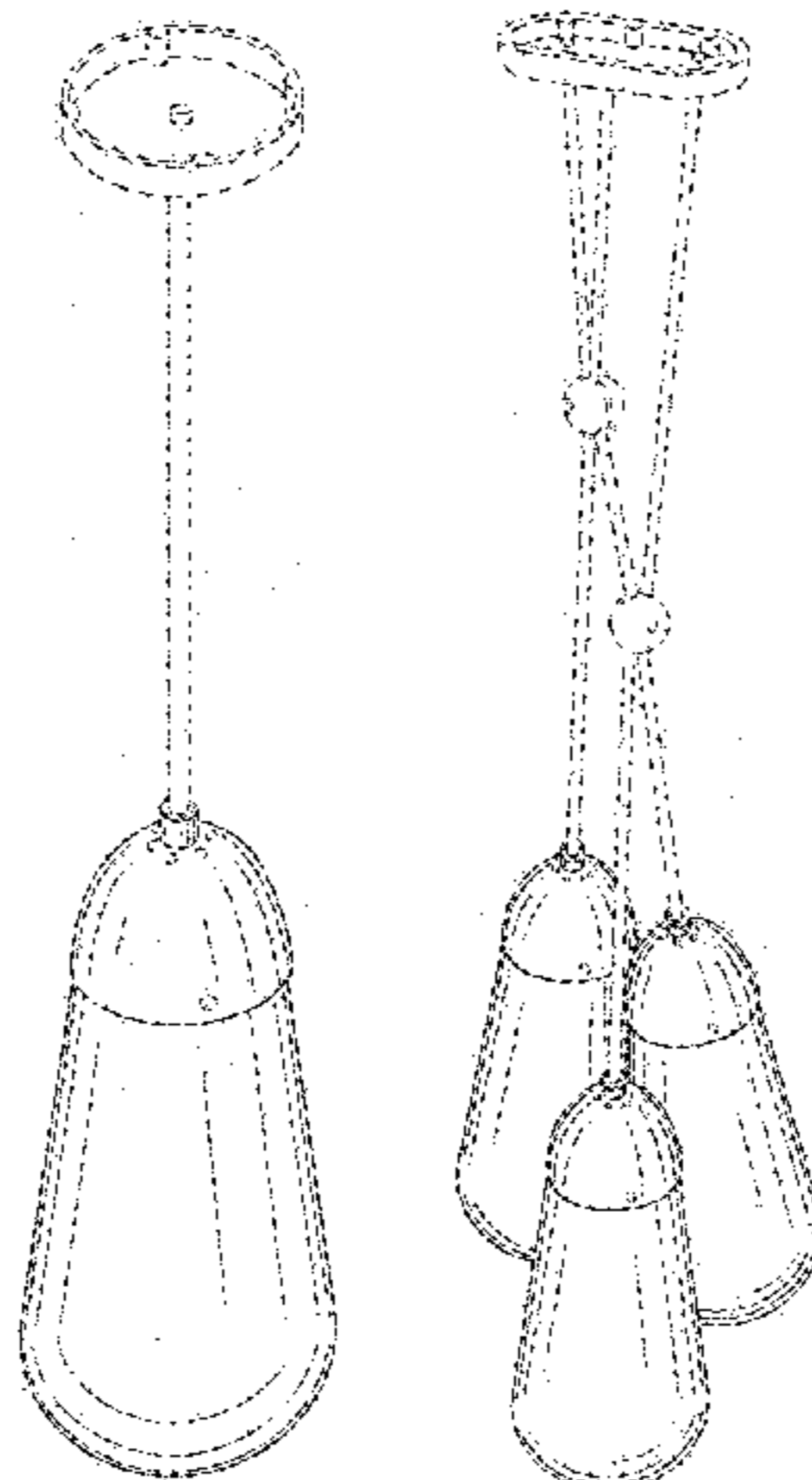

FIG. 17 is a front elevation view of the lighting fixture of the third embodiment;

FIG. 18 is a rear elevation view of the lighting fixture of the third embodiment;

FIG. 19 is a top plan view of the lighting fixture of the third embodiment;

FIG. 20 is a bottom view of the lighting fixture of the third embodiment;

FIG. 21 is a perspective view of the lighting fixture of the third embodiment;

FIG. 22 is a left elevation view showing a fourth embodiment of my new design of a lighting fixture;

FIG. 23 is a right elevation view of the lighting fixture of the fourth embodiment;

FIG. 24 is a front elevation view of the lighting fixture of the fourth embodiment;

FIG. 25 is a rear elevation view of the lighting fixture of the fourth embodiment;

FIG. 26 is a top plan view of the lighting fixture of the fourth embodiment;

FIG. 27 is a bottom view of the lighting fixture of the fourth embodiment;

FIG. 28 is a perspective view of the lighting fixture of the fourth embodiment;

FIG. 29 is a left elevation view showing a fifth embodiment of my new design of a lighting fixture;

FIG. 30 is a right elevation view of the lighting fixture of the fifth embodiment;

FIG. 31 is a front elevation view of the lighting fixture of the fifth embodiment;

FIG. 32 is a rear elevation view of the lighting fixture of the fifth embodiment;

FIG. 33 is a top plan view of the lighting fixture of the fifth embodiment;

FIG. 34 is a bottom view of the lighting fixture of the fifth embodiment; and,

FIG. 35 is a perspective view of the lighting fixture of the fifth embodiment.

The broken lines depict unclaimed environment. The broken lines form no part of the claimed design.

**1 Claim, 35 Drawing Sheets**

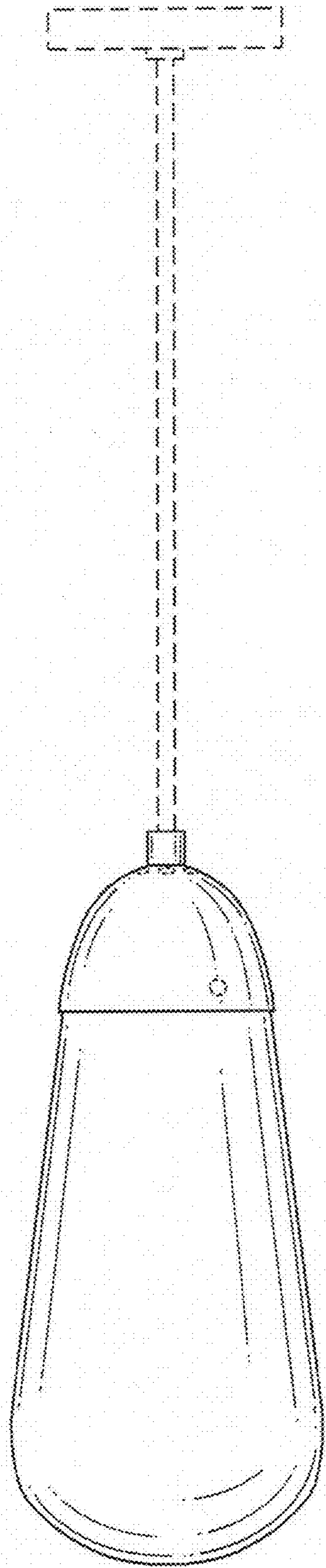

FIG. 1

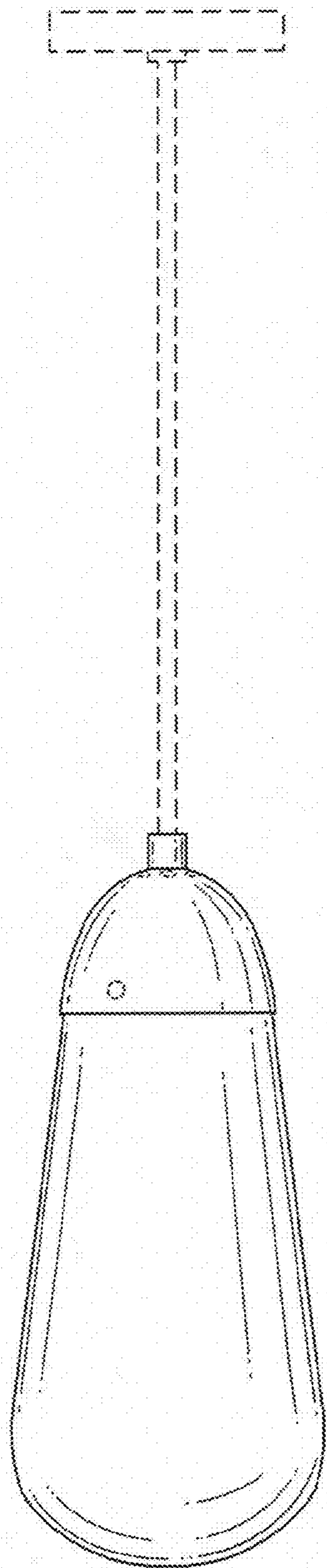

FIG. 2



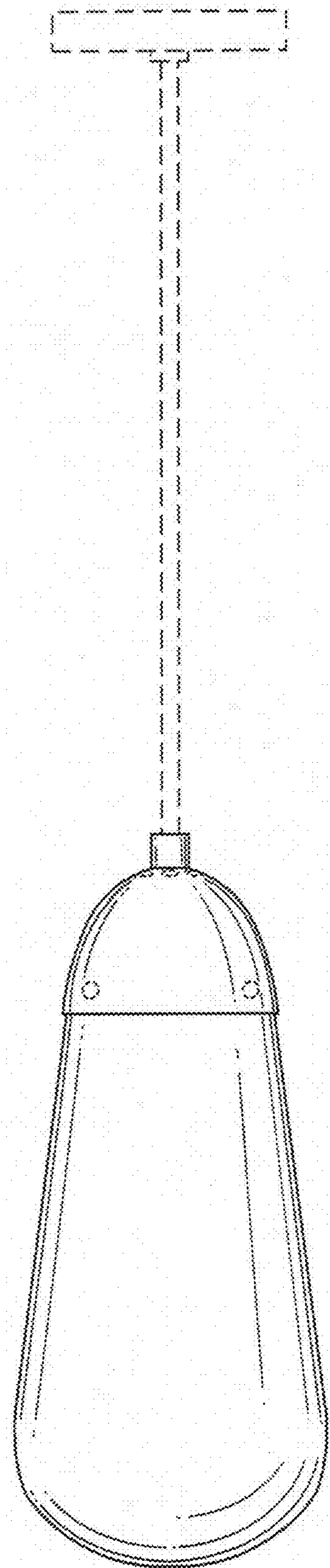

FIG. 3

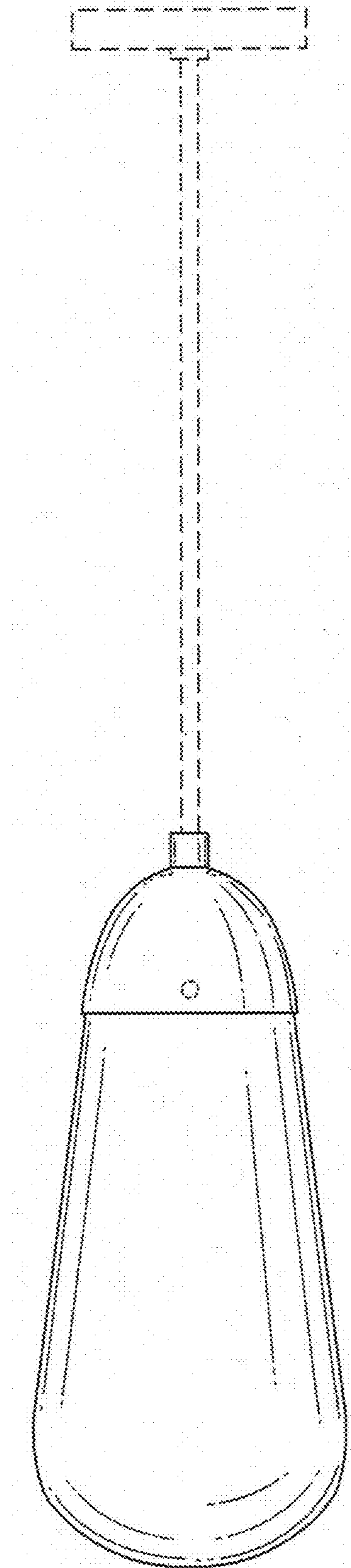

FIG. 4

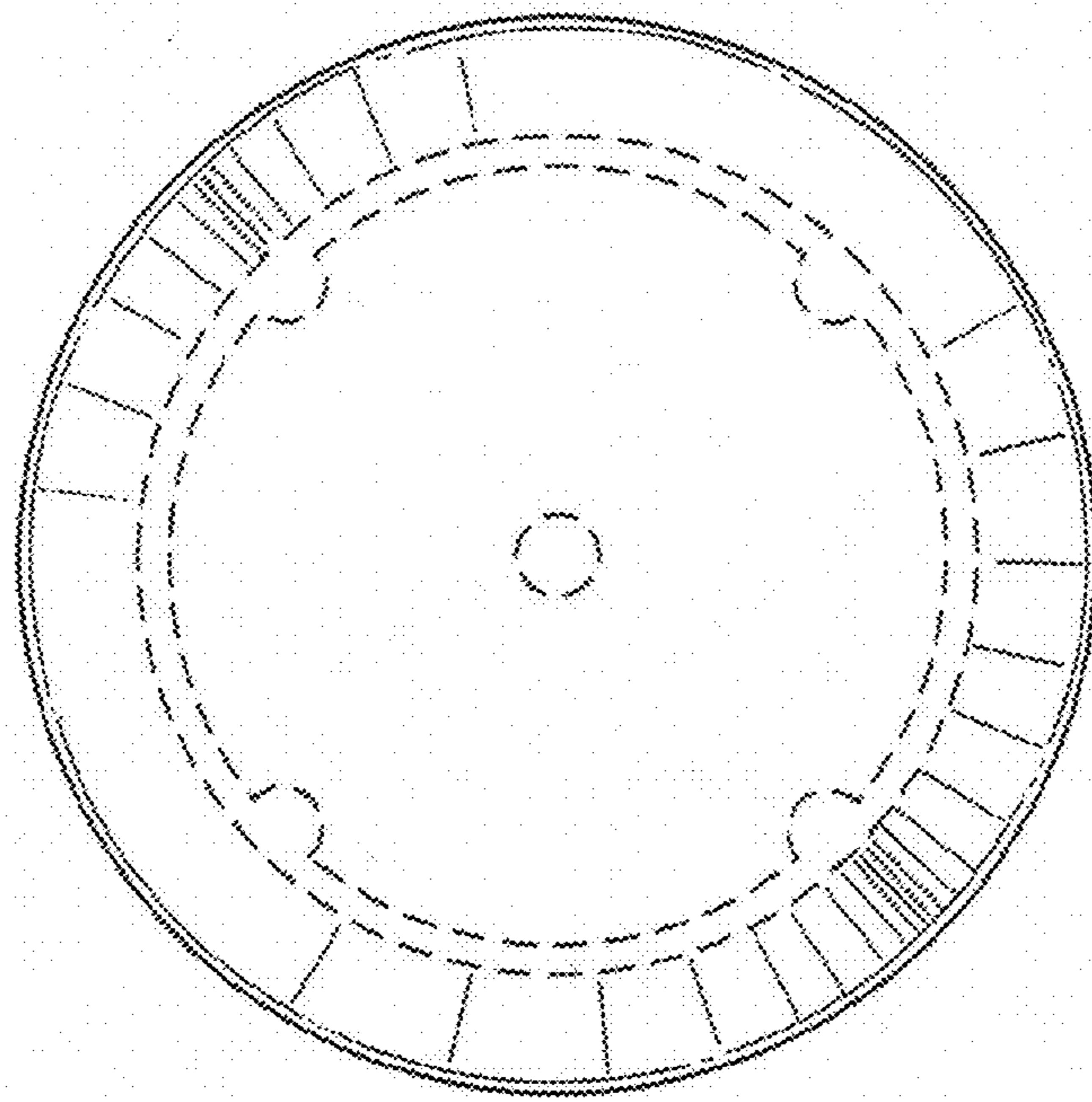

FIG. 5

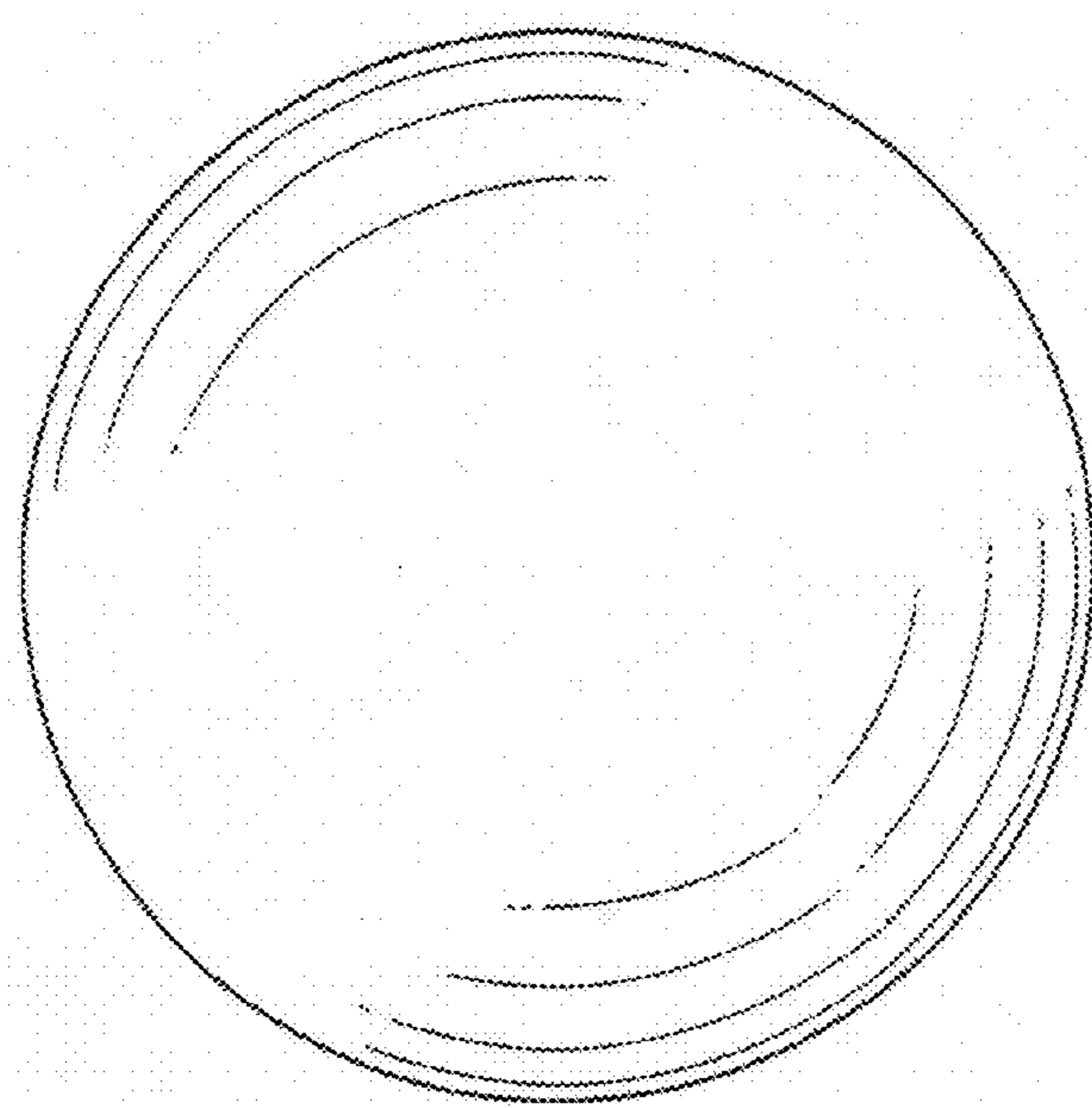

FIG. 6



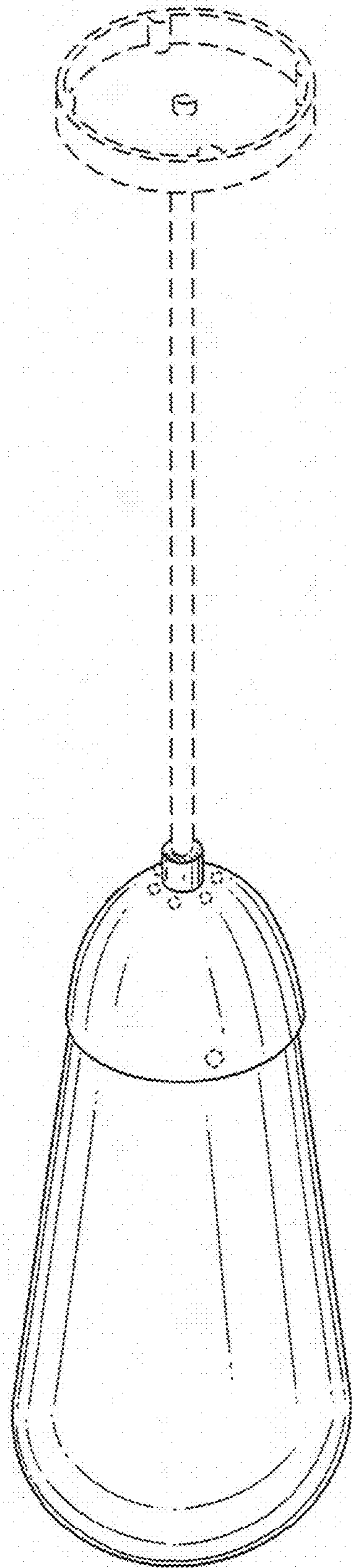

FIG. 7

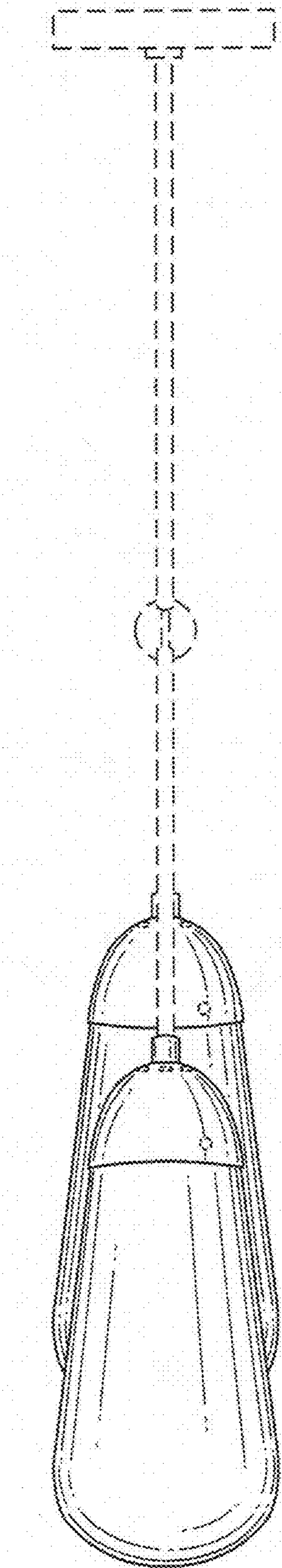

FIG. 8

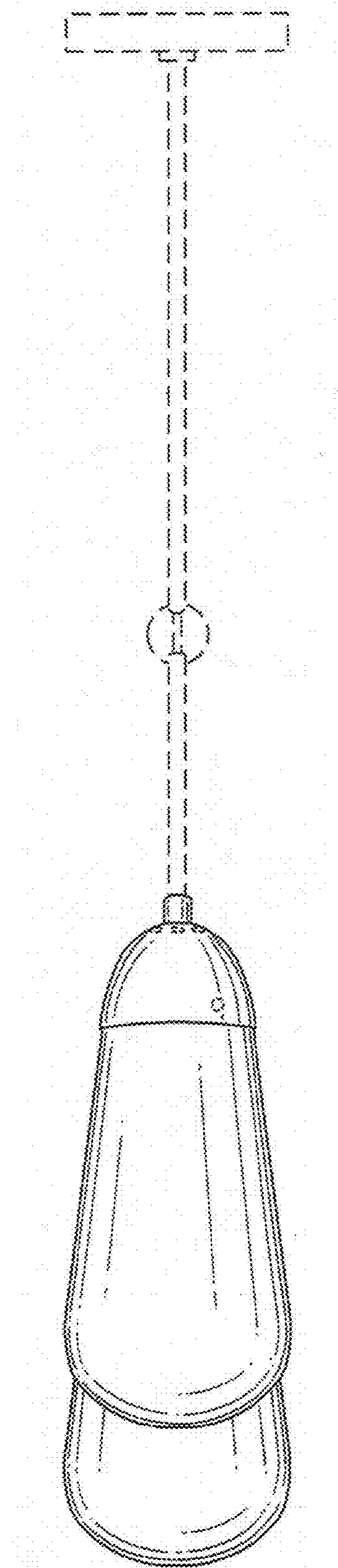

FIG. 9

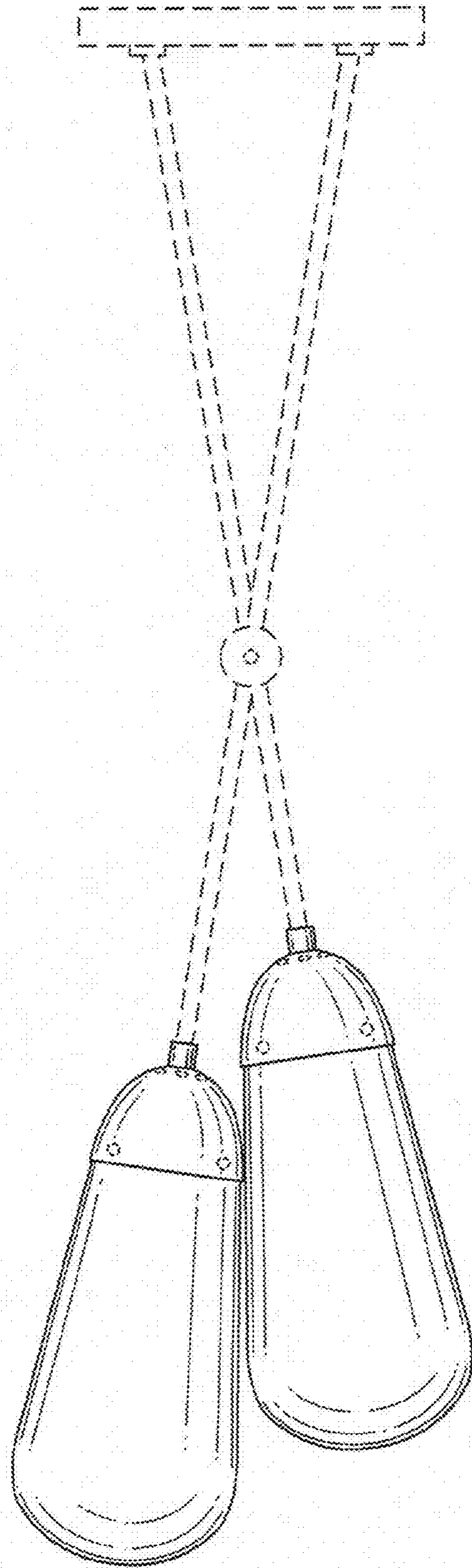

FIG. 10

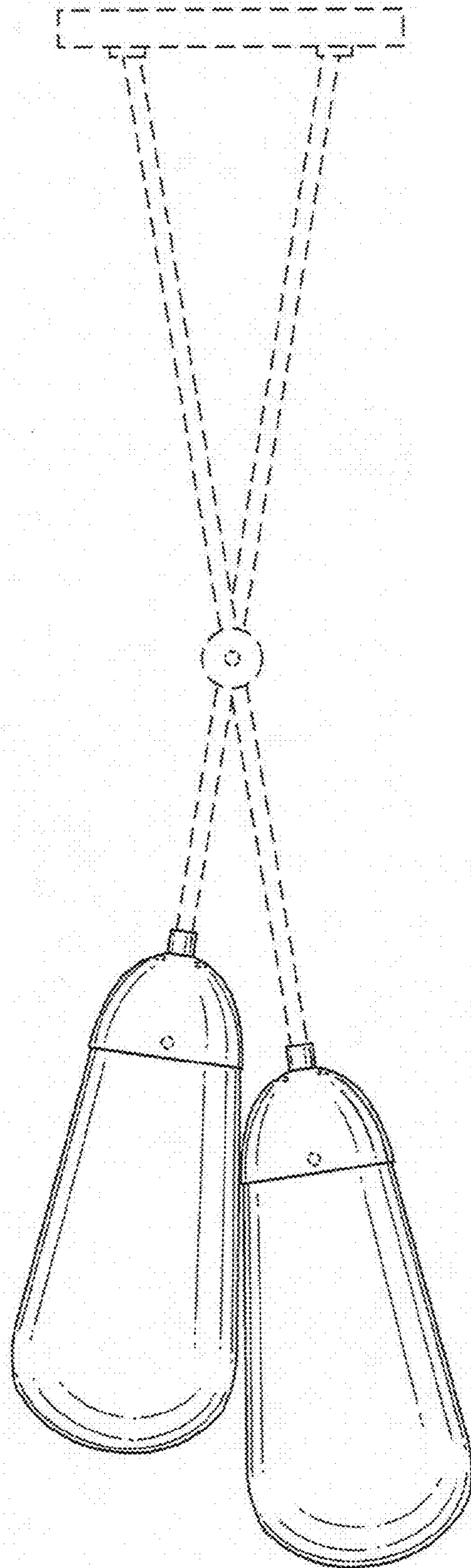

FIG. 11



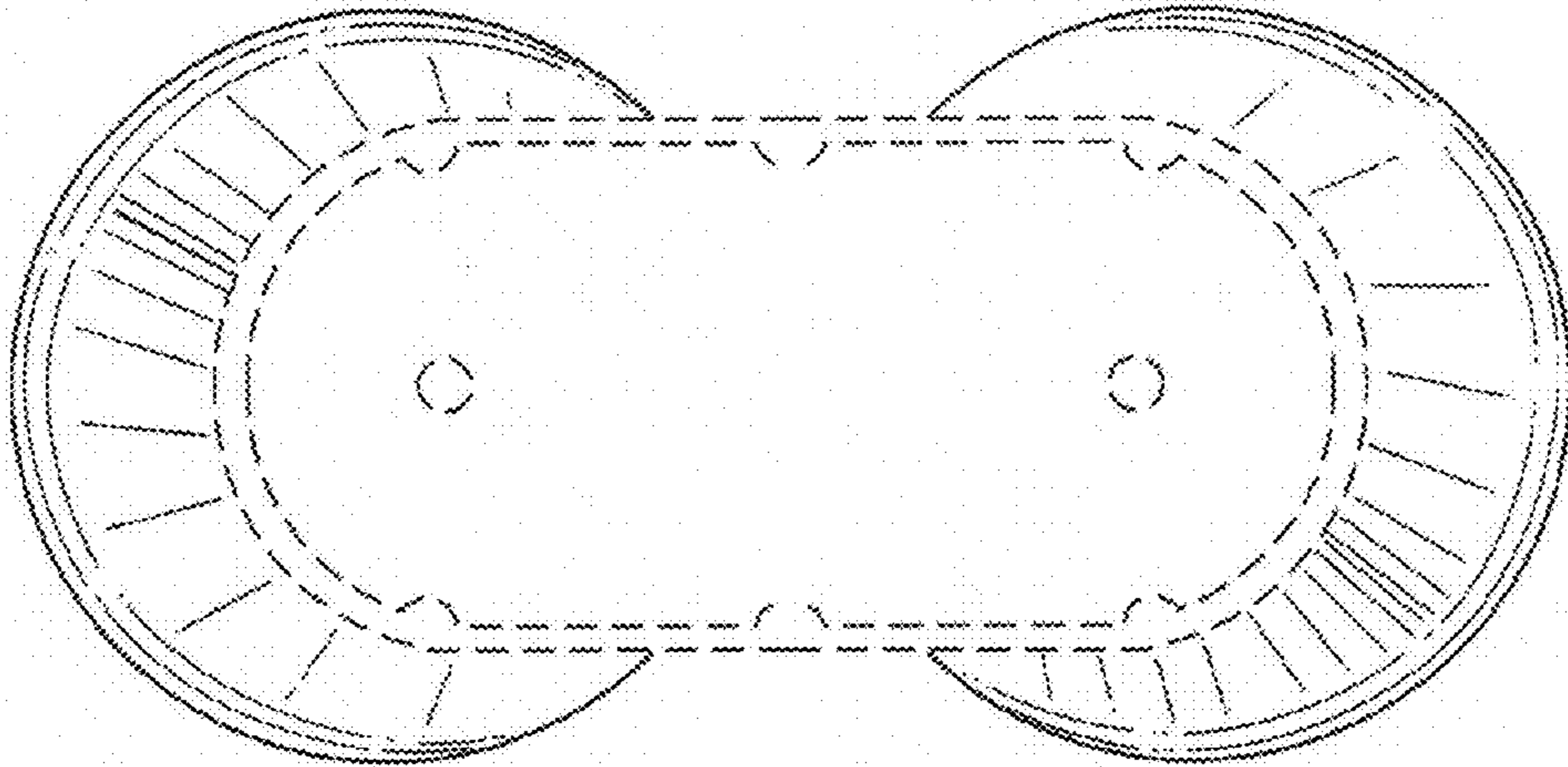

FIG. 12

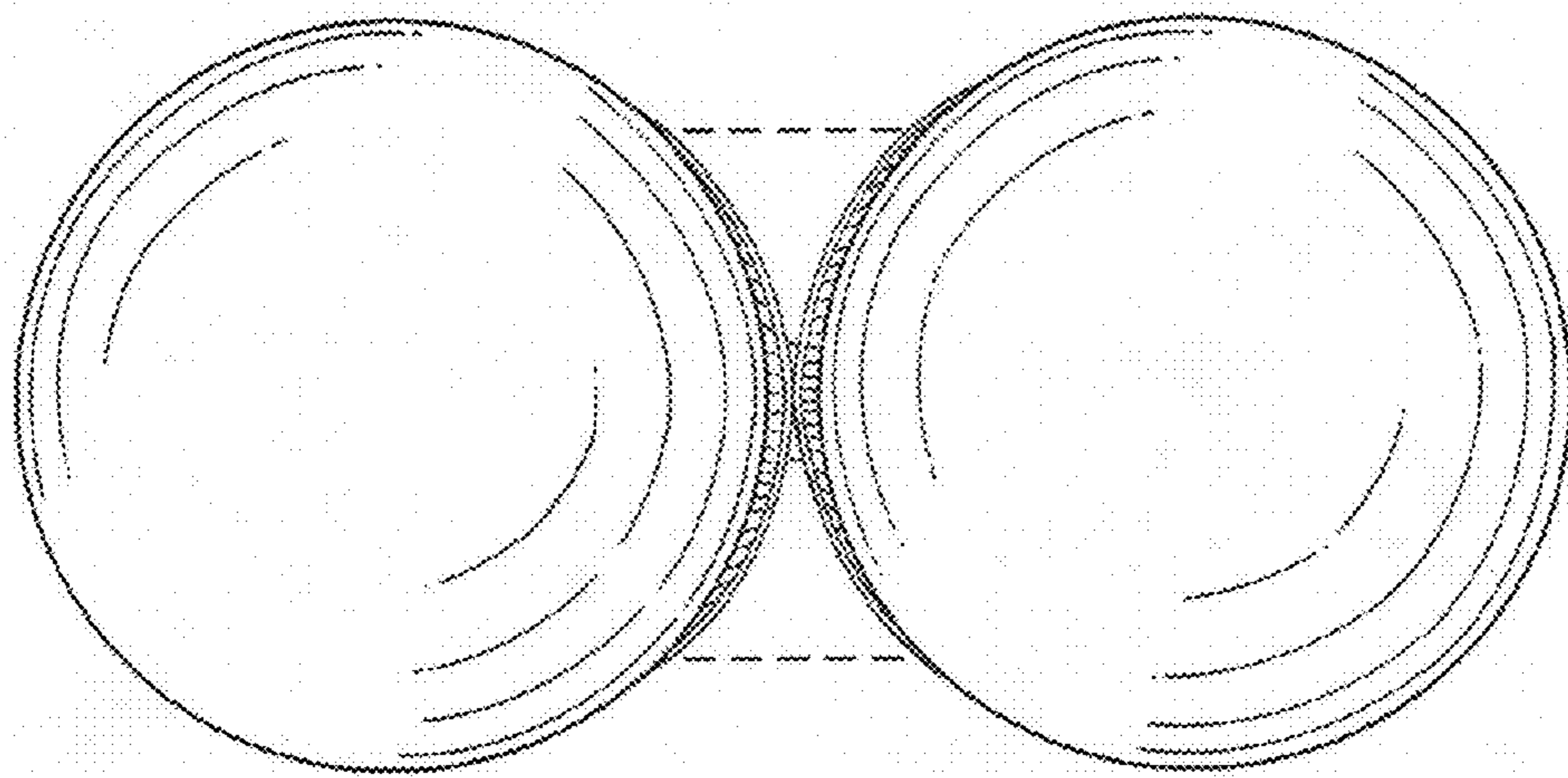

FIG. 13

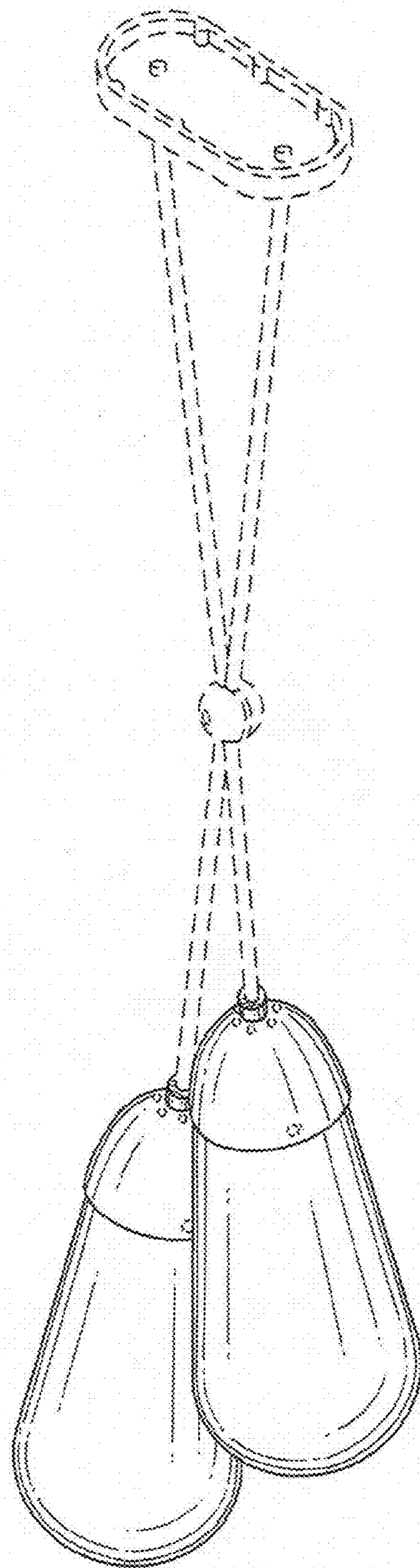

FIG. 14

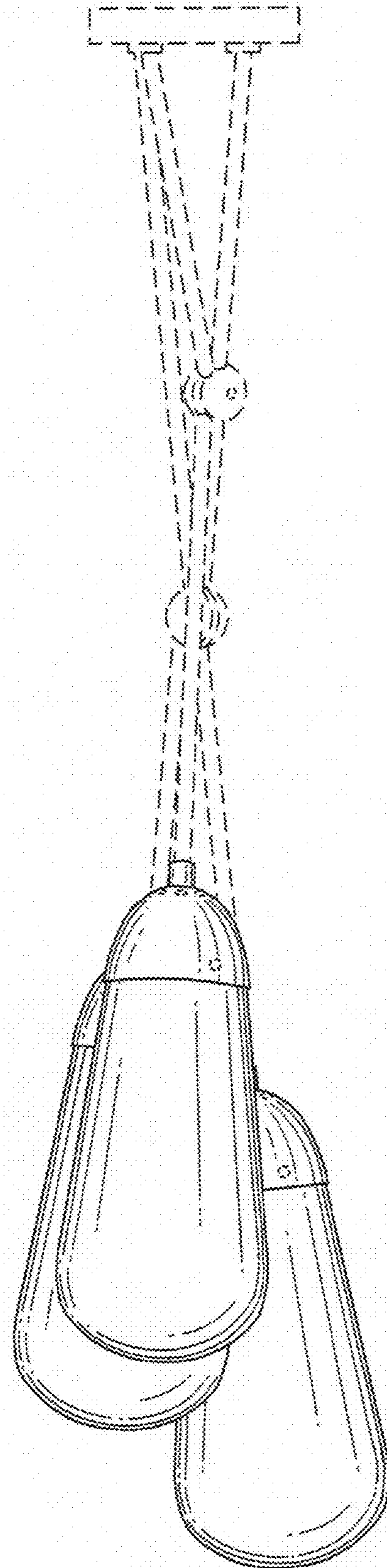

FIG. 15

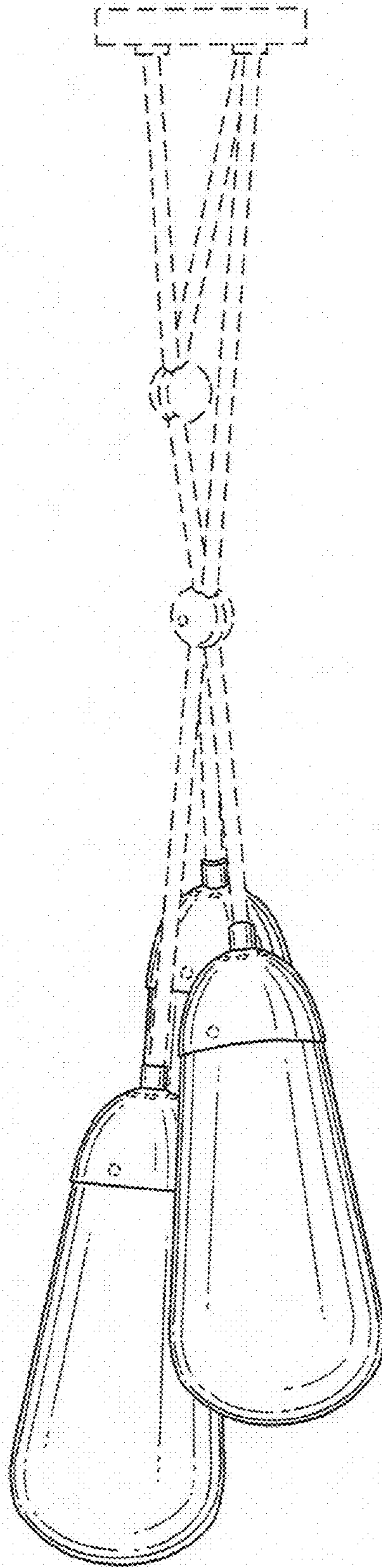

FIG. 16



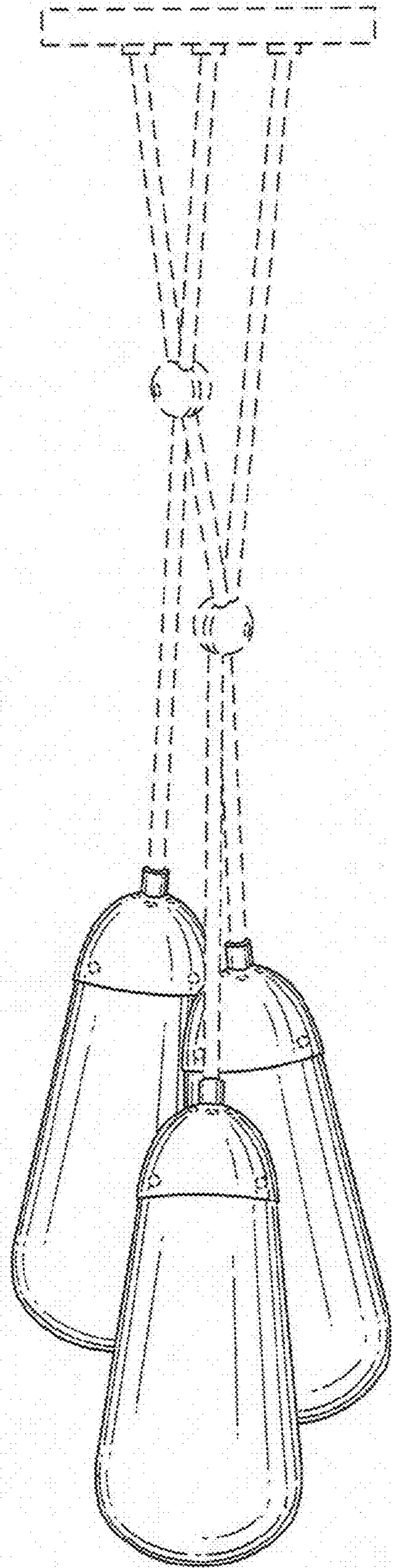

FIG. 17

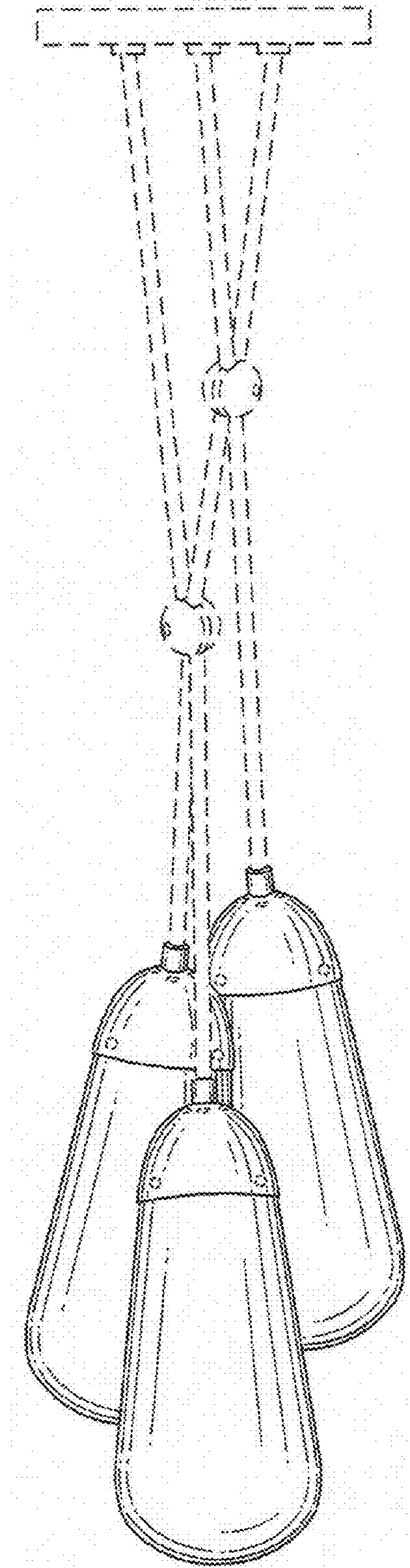

FIG. 18

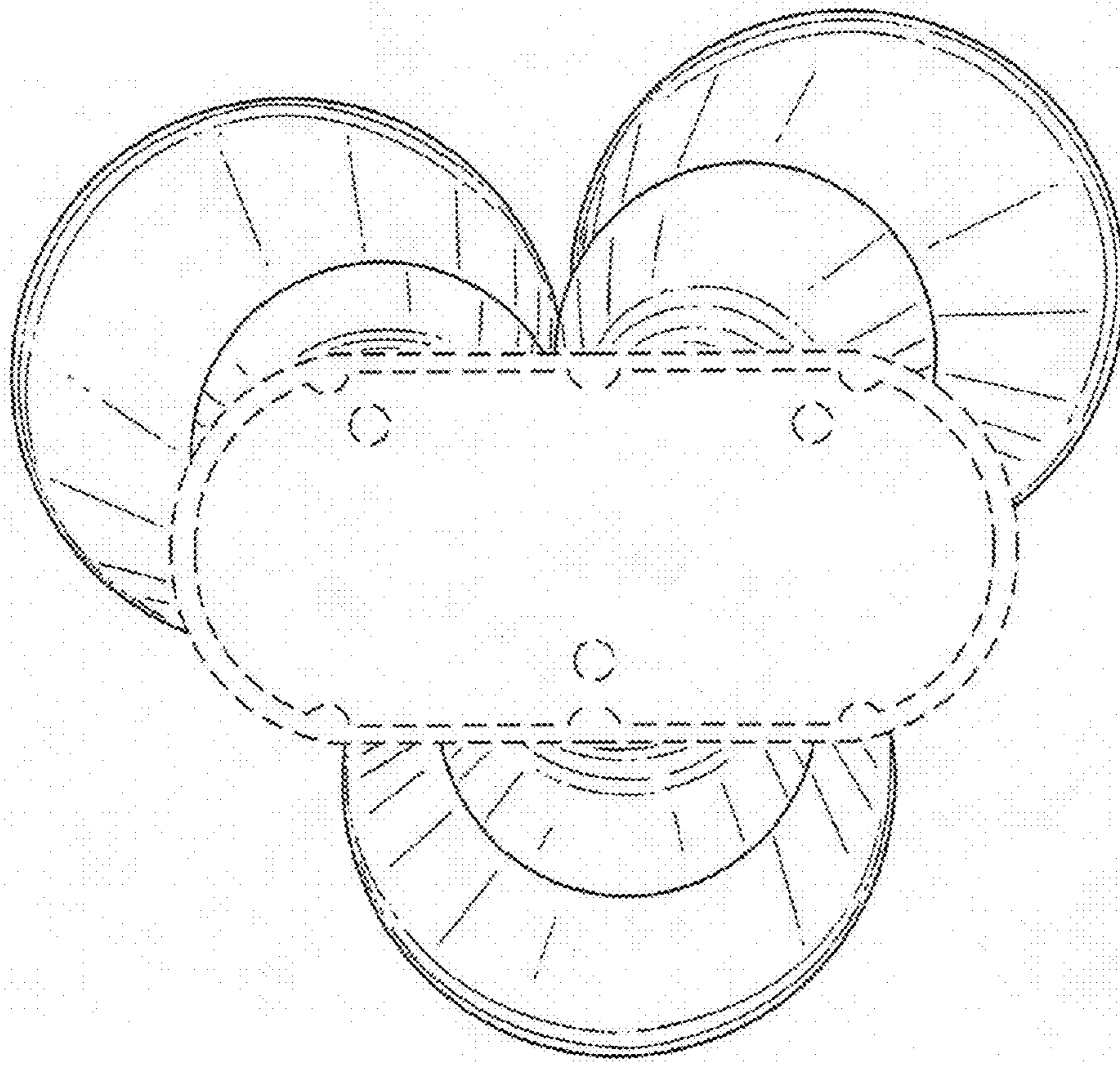

FIG. 19

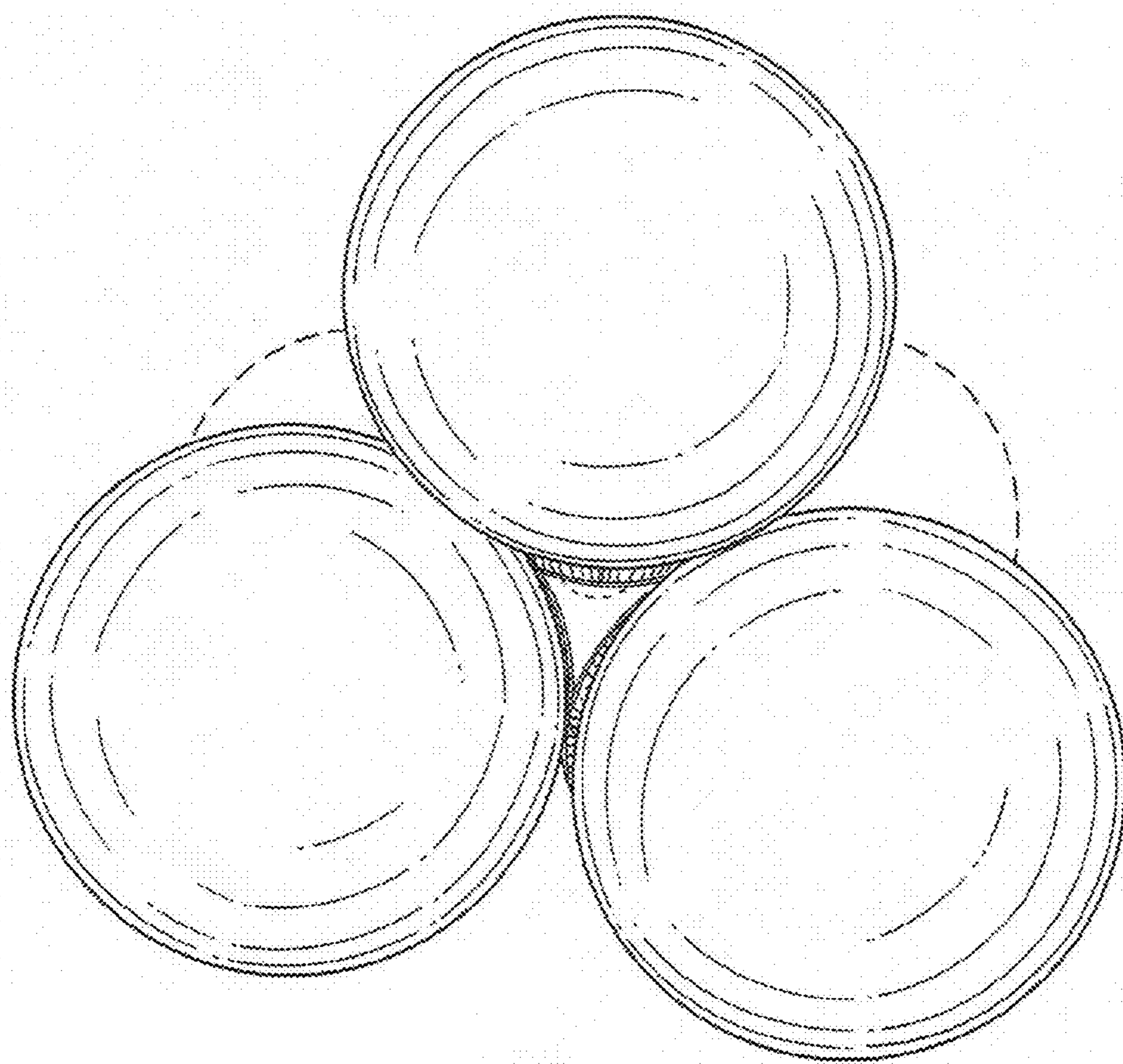

FIG. 20



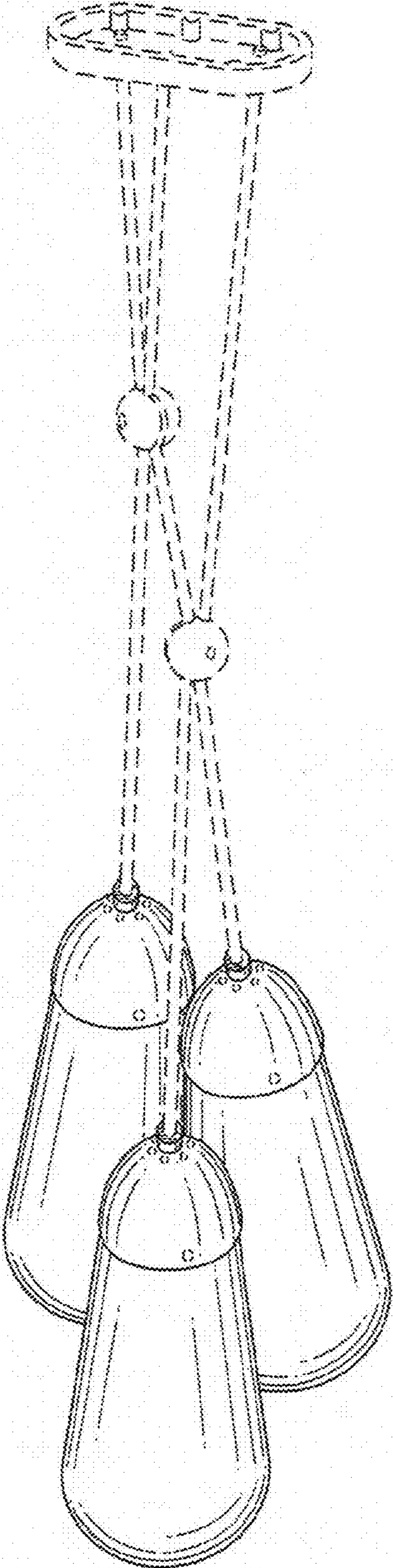

FIG. 21



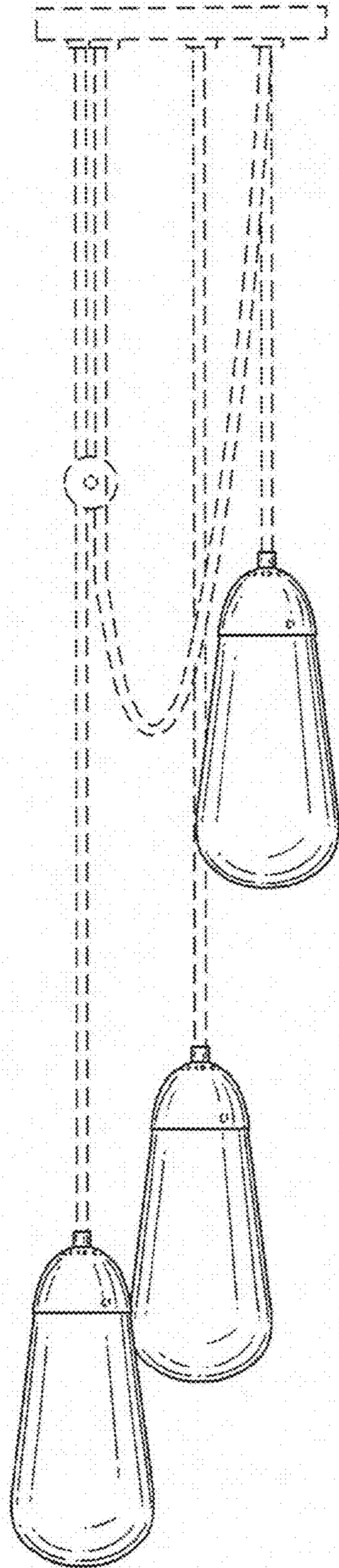

FIG. 22

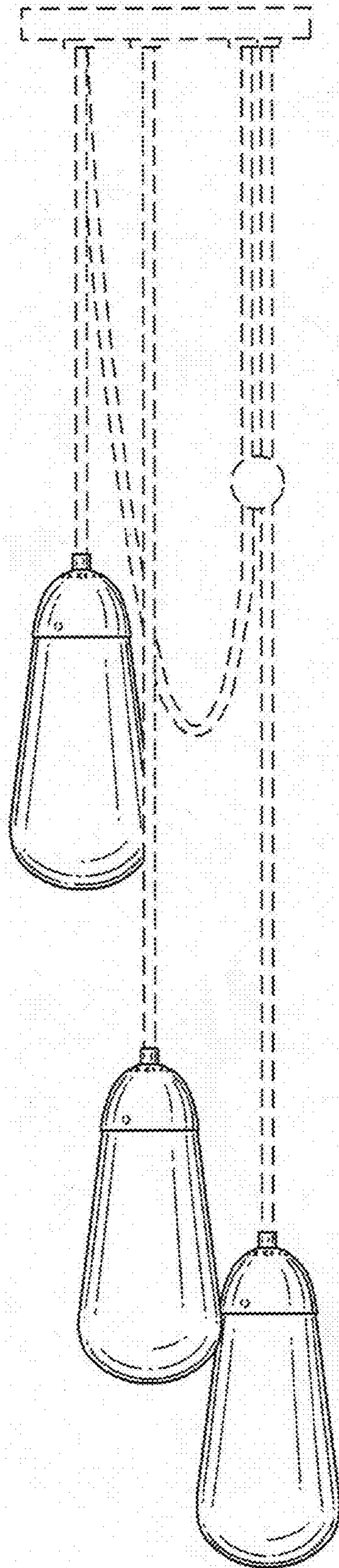

FIG. 23

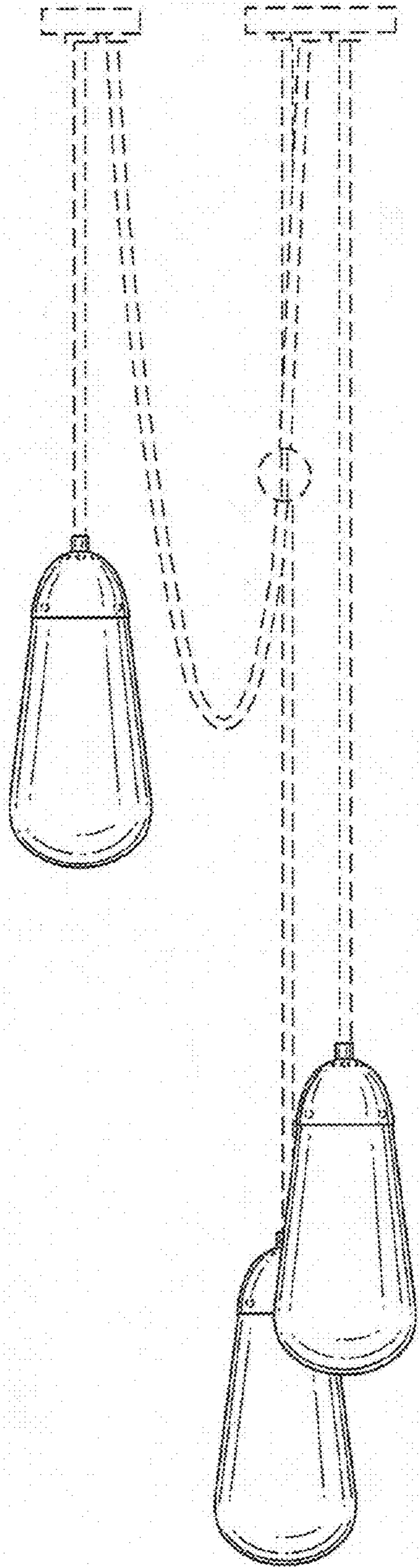

FIG. 24

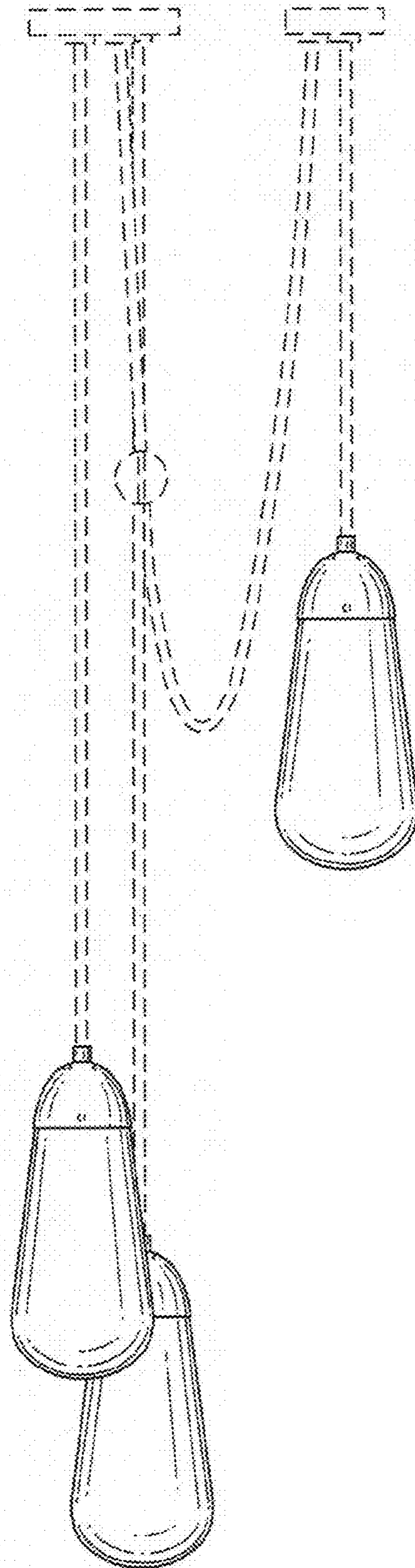

FIG. 25



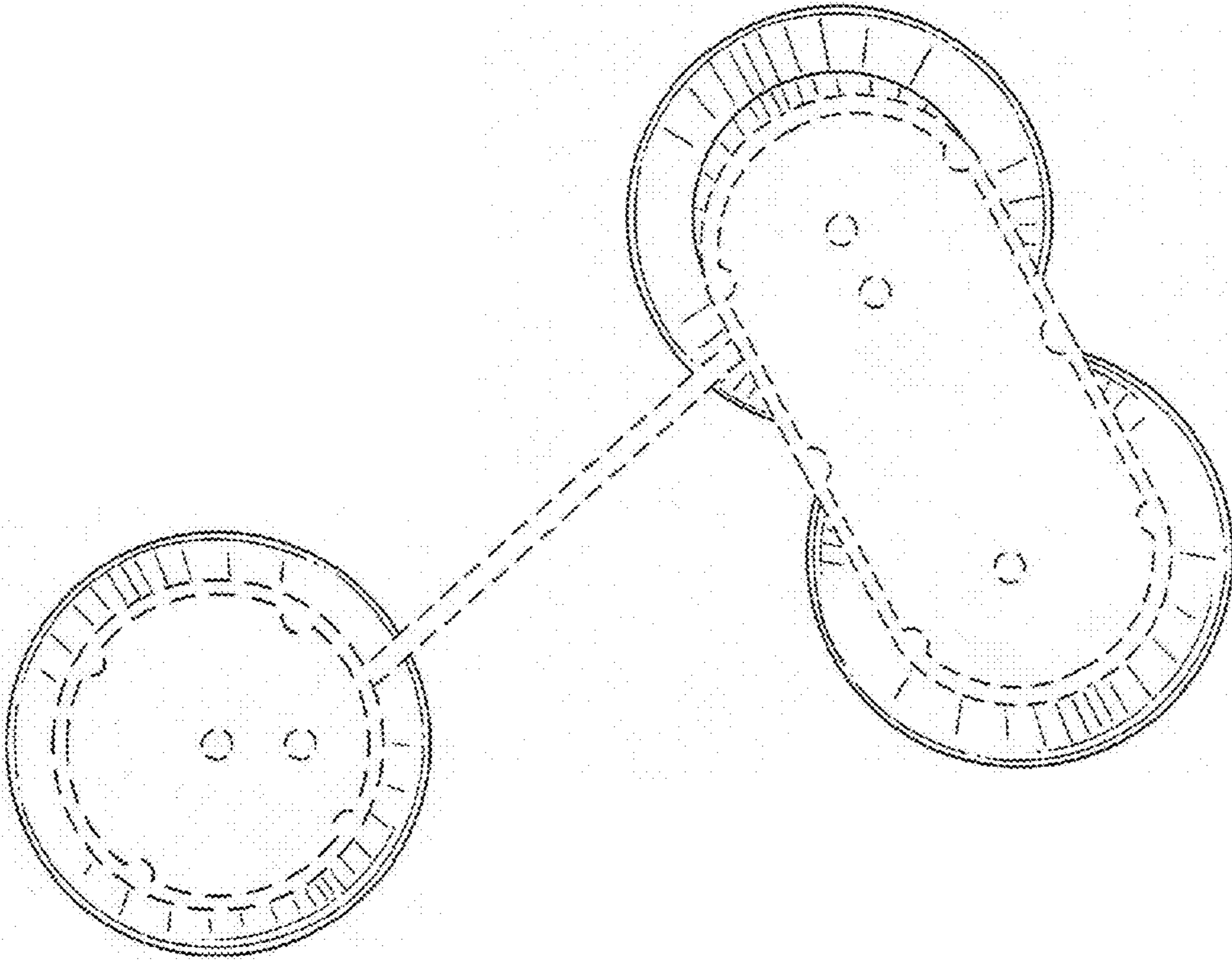

FIG. 26



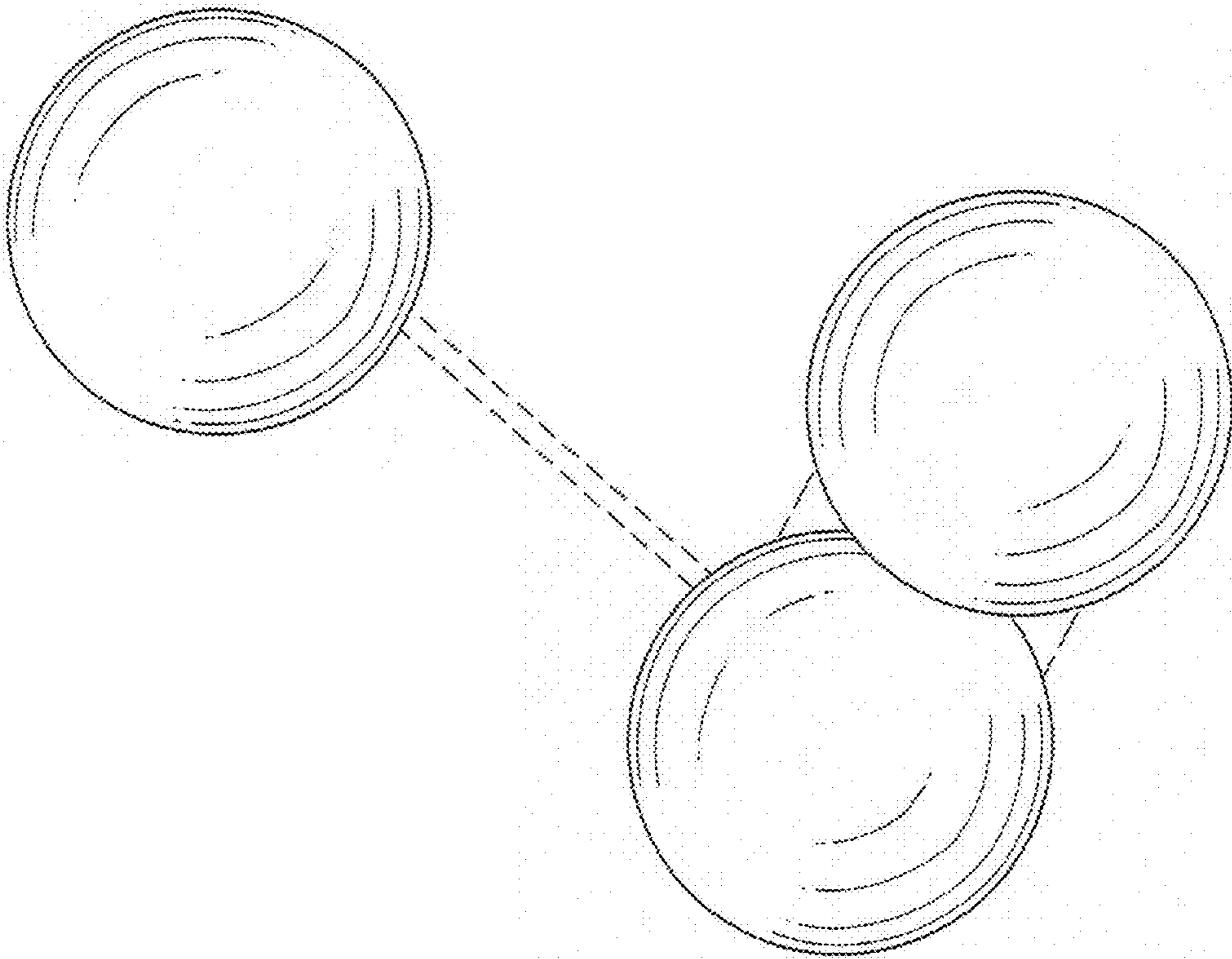

FIG. 27

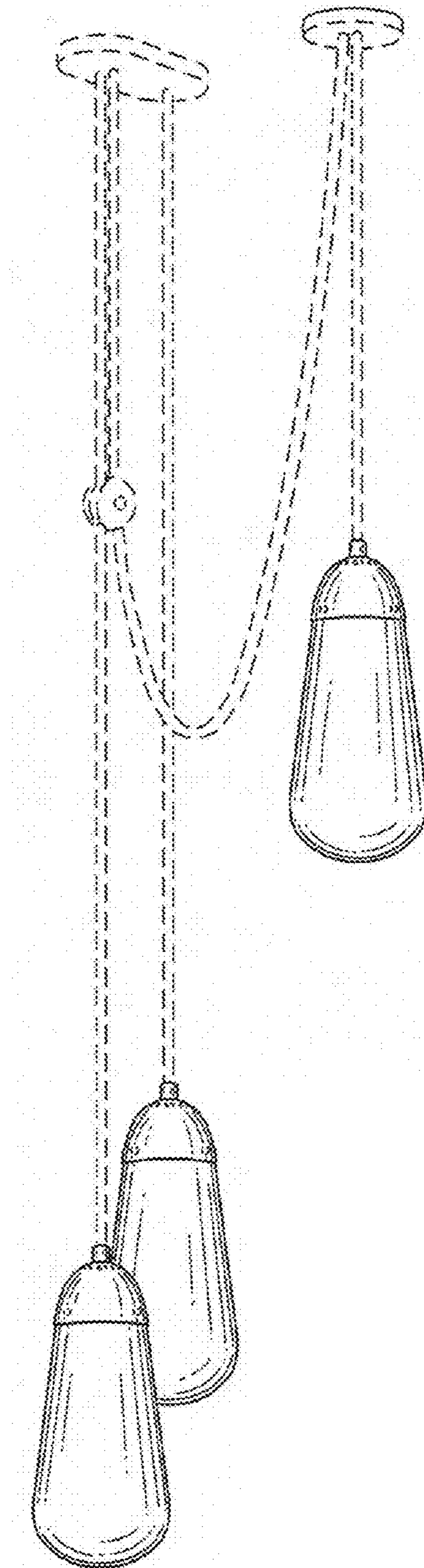

FIG. 28

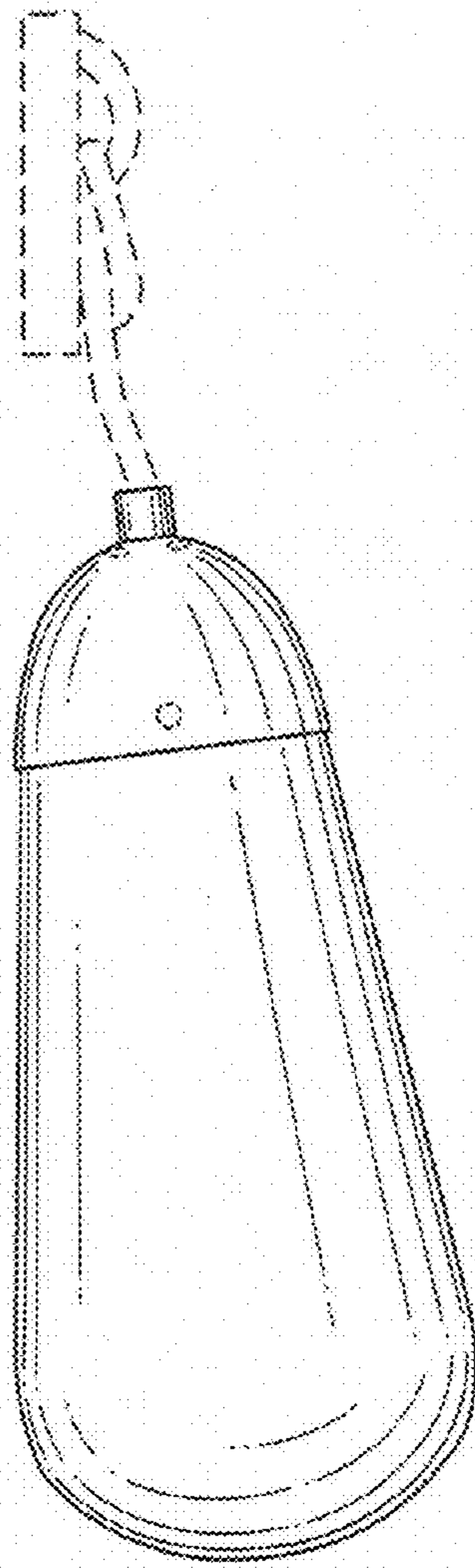
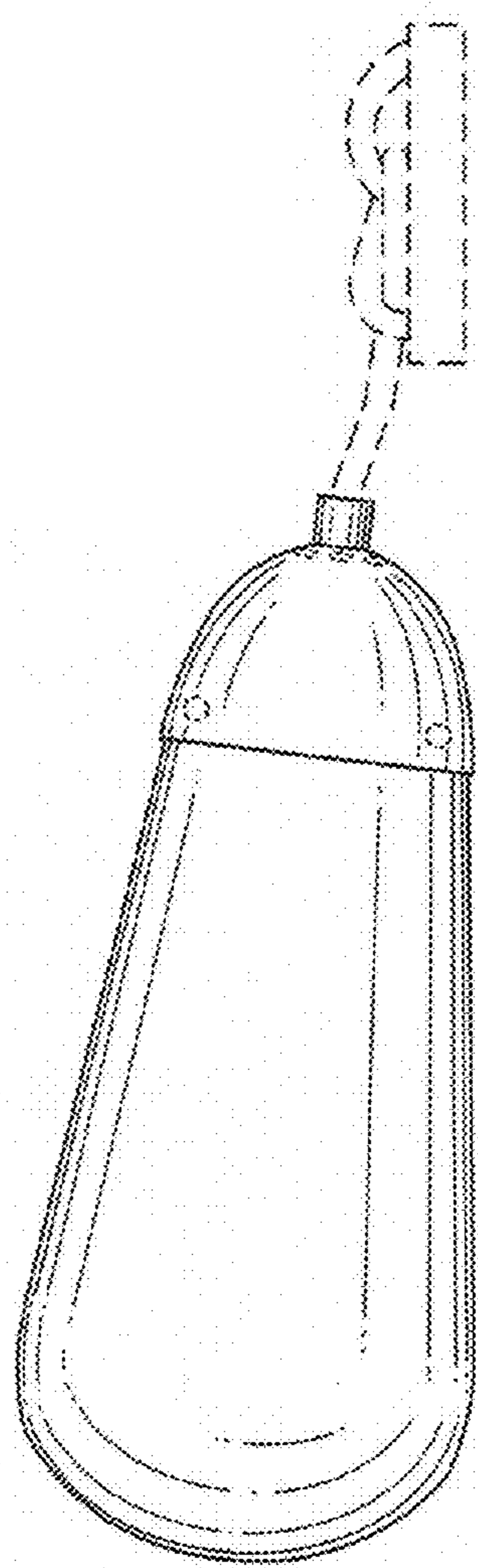

FIG. 29

FIG. 30



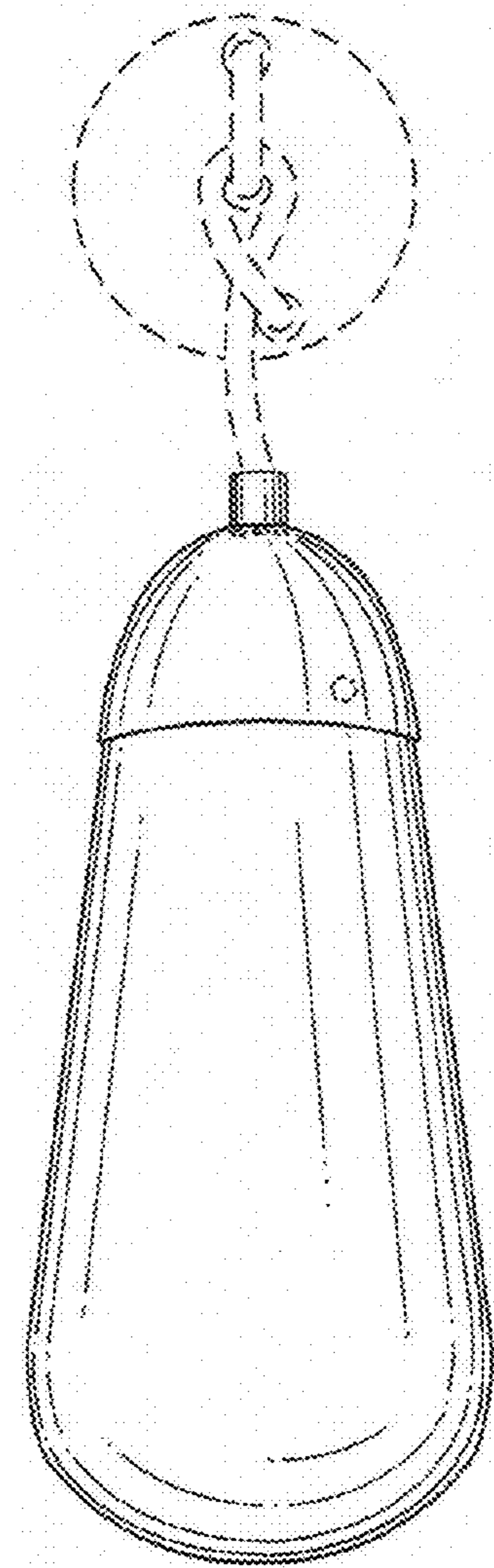

FIG. 31



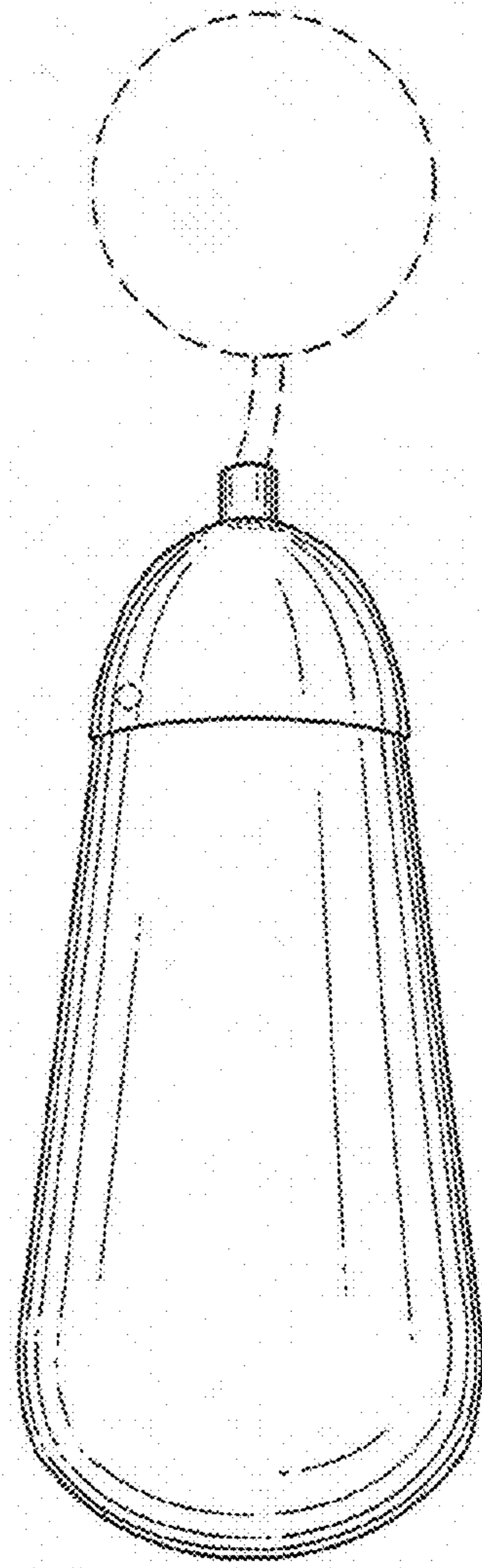

FIG. 32

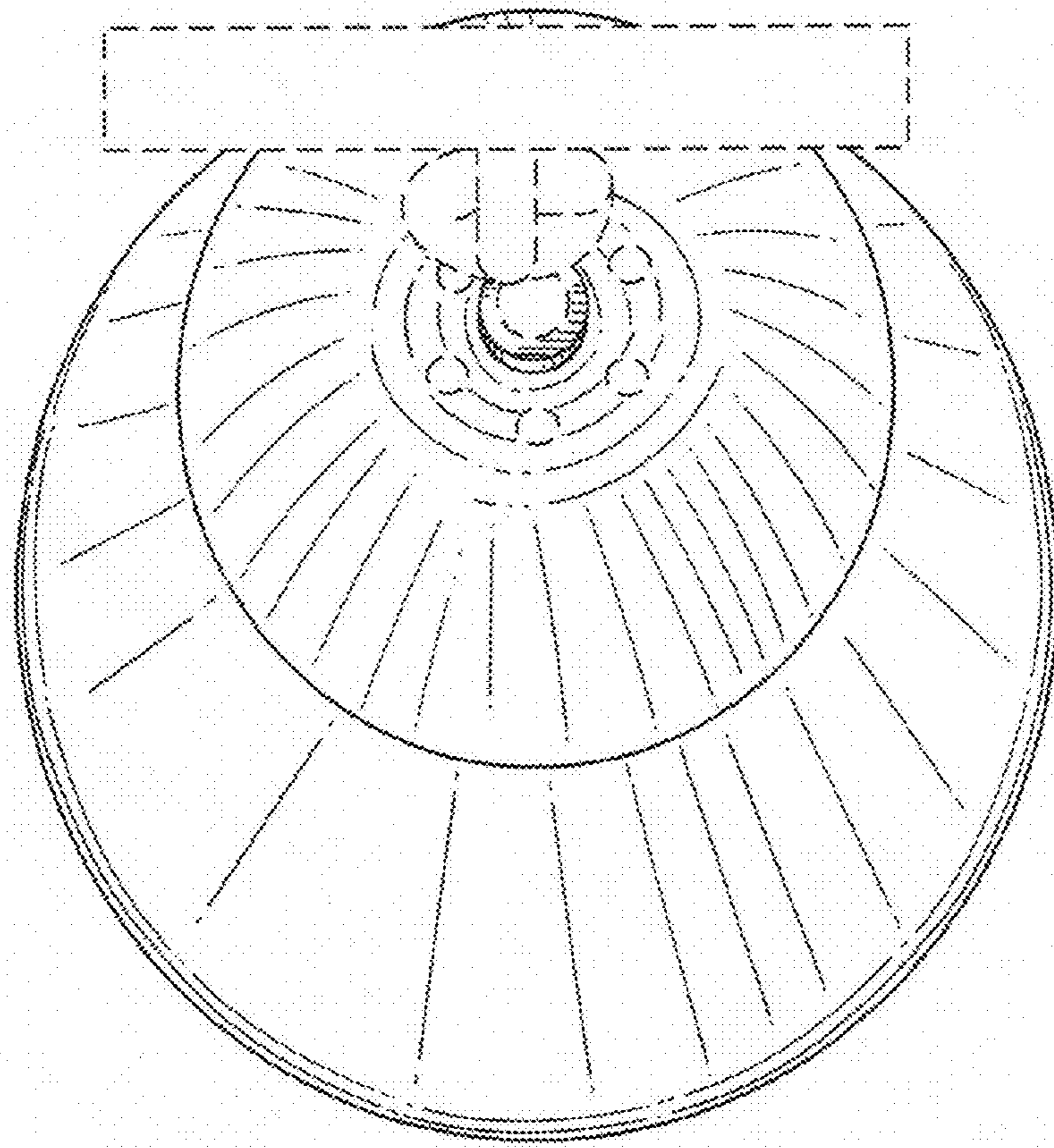

FIG. 33

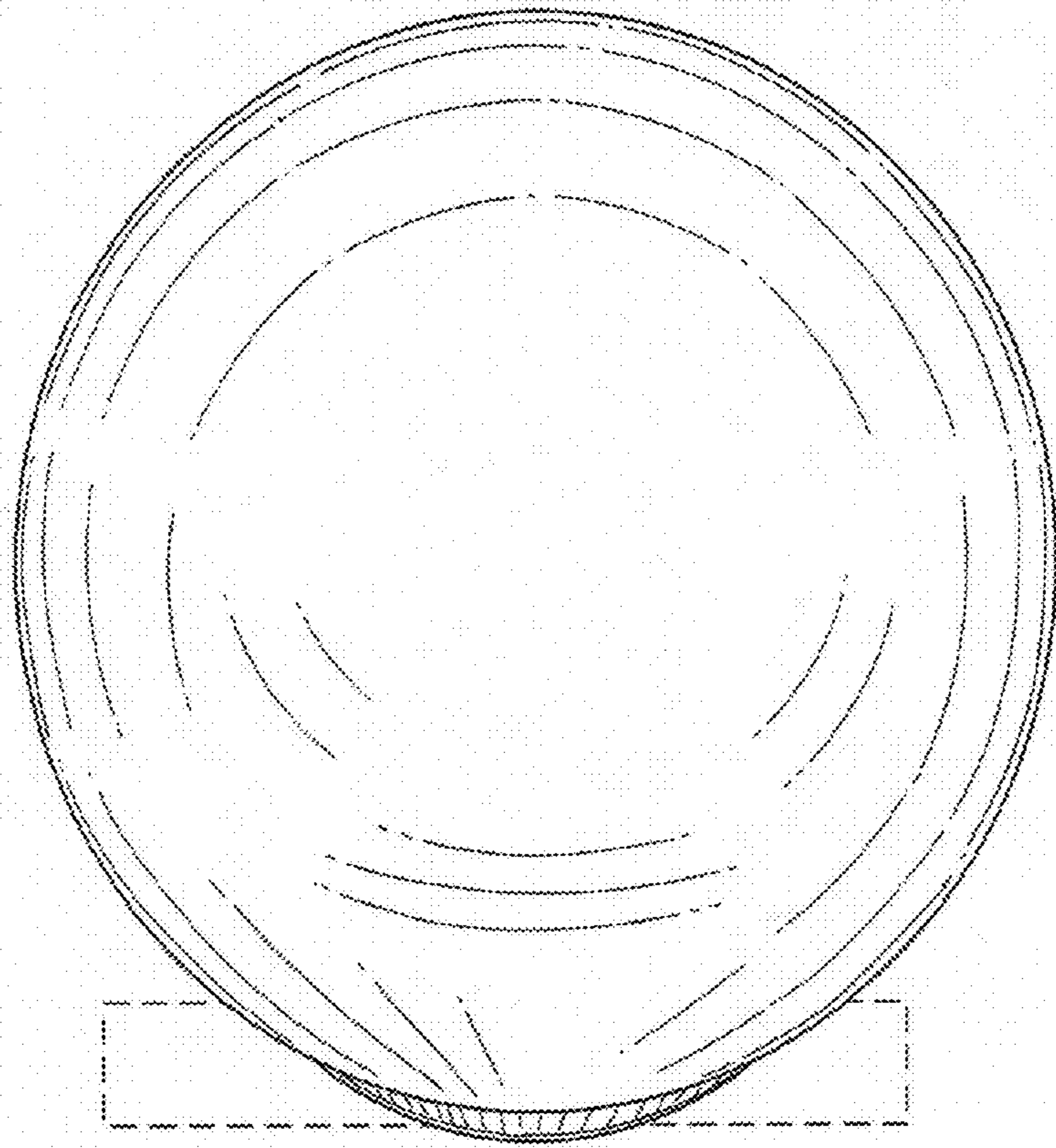

FIG. 34

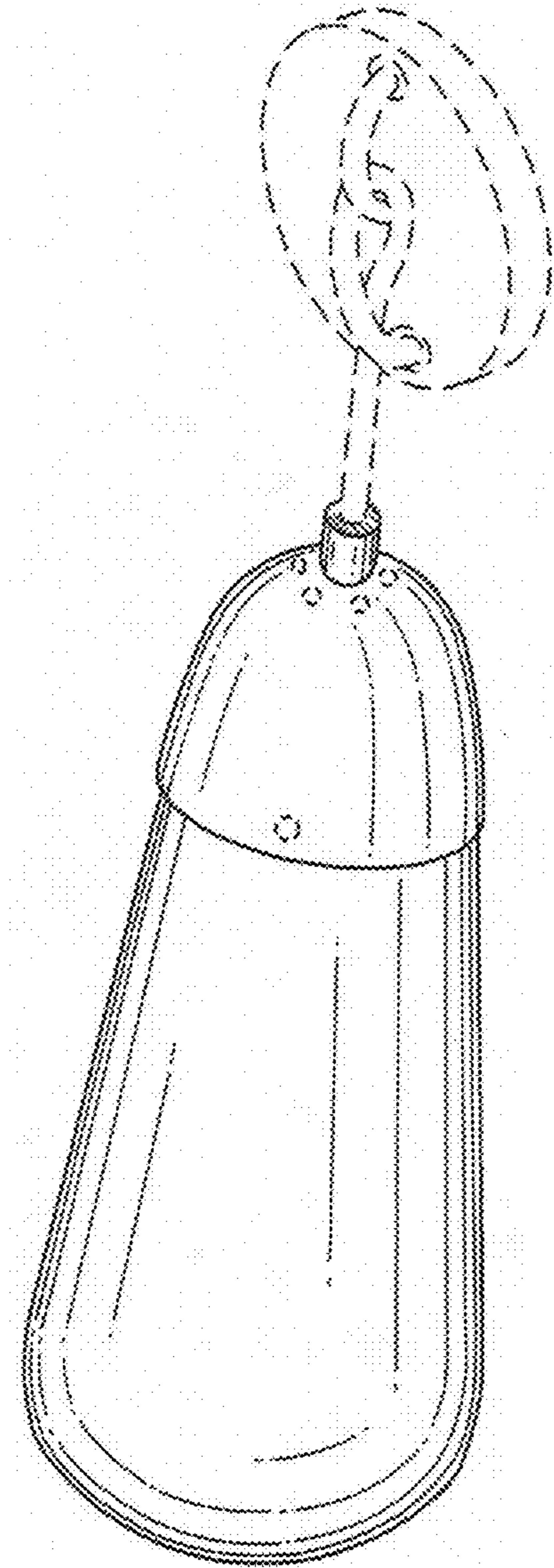

FIG. 35