



US00D757320S

(12) **United States Design Patent**
Bartos

(10) **Patent No.:** **US D757,320 S**

(45) **Date of Patent:** **** May 24, 2016**

(54) **ILLUMINATED FRET BOARD**

(71) Applicant: **James Bartos**, Norwood, NJ (US)

(72) Inventor: **James Bartos**, Norwood, NJ (US)

(**) Term: **14 Years**

(21) Appl. No.: **29/433,813**

(22) Filed: **Oct. 4, 2012**

5,517,891 A	5/1996	Sica	
5,796,025 A	8/1998	Haake	
5,977,462 A *	11/1999	Wolfson	84/267
6,080,925 A *	6/2000	Rogers et al.	84/485 R
6,162,981 A	12/2000	Newcomer	
6,191,348 B1	2/2001	Johnson	
6,191,350 B1	2/2001	Okulov	
6,201,174 B1	3/2001	Eller	
D440,001 S *	4/2001	Marella	D26/73
6,217,183 B1 *	4/2001	Shipman	362/30
6,288,315 B1 *	9/2001	Bennett	84/470 R
6,376,756 B1 *	4/2002	Beckmeier	84/293
6,452,081 B1	9/2002	Ravagni	

(Continued)

Related U.S. Application Data

(63) Continuation-in-part of application No. 12/836,848, filed on Jul. 15, 2010, now Pat. No. 9,218,747.

(51) **LOC (10) Cl.** **26-05**

(52) **U.S. Cl.**
USPC **D26/51; D17/9**

(58) **Field of Classification Search**
USPC D26/51, 38, 52; D17/14, 18-20, 99;
84/290-293, 314 R, 453, 267;
362/23.03, 253

CPC ... F21V 33/00; F21V 14/025; F21V 21/0406;
F21Y 2101/02; F21L 2003/00; F21L 2005/00;
G10D 3/06; G10D 1/08; G10D 1/085

See application file for complete search history.

(56) **References Cited**

U.S. PATENT DOCUMENTS

1,751,048 A *	3/1930	Miessner	84/485 R
1,821,516 A	9/1931	Hohn	
1,991,864 A *	2/1935	Nopola et al.	84/477 R
2,001,191 A *	5/1935	Golden	84/485 R
3,785,240 A *	1/1974	Hill	84/485 R
D264,477 S	5/1982	Brent	
4,559,861 A	12/1985	Patty	
4,807,509 A	2/1989	Graham	
5,373,768 A	12/1994	Sciortino	
5,408,914 A	4/1995	Breitweiser	
D363,946 S *	11/1995	Eberlen	D17/14

Primary Examiner — Ian Simmons

Assistant Examiner — Carissa C Fitts

(74) *Attorney, Agent, or Firm* — The Fletcher Law Firm PLLC; Brian N. Fletcher

(57) **CLAIM**

I claim the ornamental design for an illuminated fret board, as shown and described.

DESCRIPTION

FIG. 1 is a top plan view of an illuminated fret board, showing a first embodiment of my new design;

FIG. 2 is a partial top plan view thereof, as outlined by line 2-2 of FIG. 1;

FIG. 3 is a partial top plan view thereof, as outlined by line 3-3 of FIG. 1;

FIG. 4 is a partial top plan view thereof, as outlined by line 4-4 of FIG. 1;

FIG. 5 is a cross-sectional view of an embodiment, taken along lines 5-5 of FIG. 1;

FIG. 6 is a partial top plan view of FIG. 1; and,

FIG. 7 is a left-side elevational view of FIG. 1.

The broken lines showing a guitar body and headstock in FIG. 1 and guitar strings in FIGS. 1 and 5 depict environmental matter and form no part of the claimed design.

1 Claim, 6 Drawing Sheets

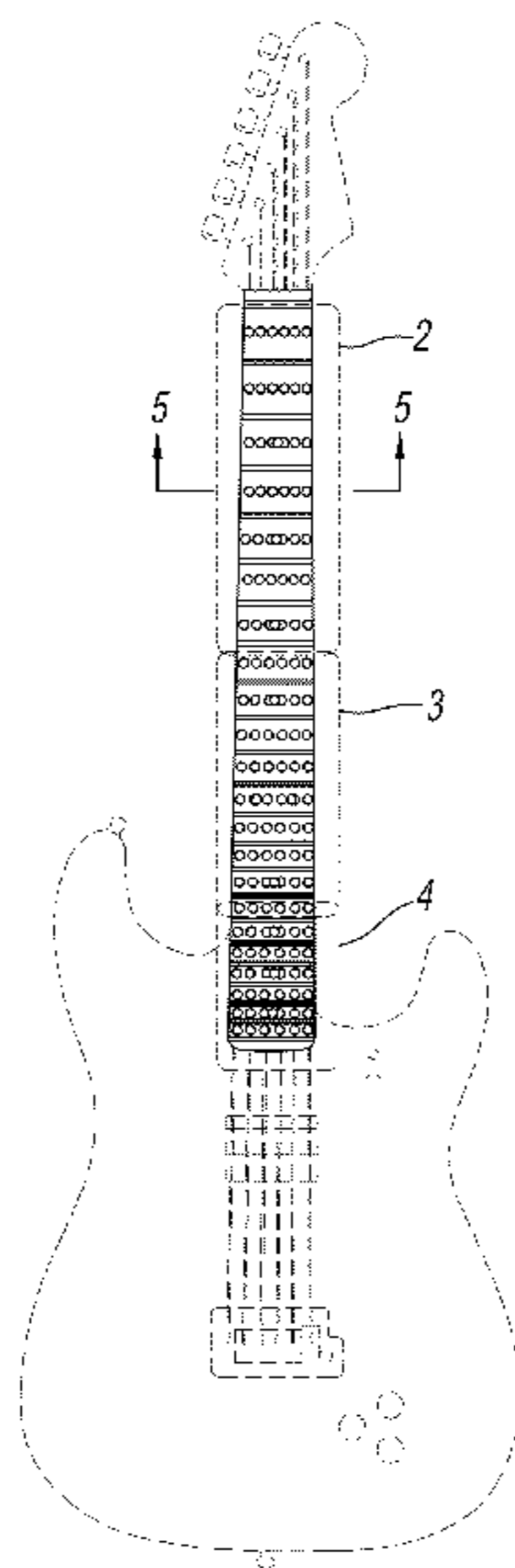

(56)

References Cited

U.S. PATENT DOCUMENTS

D480,415 S 10/2003 McGuire
 6,723,904 B1 4/2004 Dolan
 6,984,780 B2 1/2006 Reiersen
 7,084,340 B2 * 8/2006 Tan 84/477 R
 D529,092 S 9/2006 Ambrose, Sr.
 7,157,633 B1 * 1/2007 Kopesec 84/293
 7,285,709 B2 10/2007 White
 7,320,643 B1 1/2008 Brosius
 7,323,633 B2 1/2008 Shaffer
 D565,093 S 3/2008 Chan
 7,381,878 B2 6/2008 Cook
 7,402,746 B2 7/2008 Saenz
 7,408,105 B2 * 8/2008 Murdock 84/477 R
 7,427,704 B2 9/2008 Huwaldf
 7,446,253 B2 11/2008 Knapp
 7,504,578 B2 3/2009 Lewry
 7,521,619 B2 4/2009 Salter
 7,579,533 B2 * 8/2009 Jones 84/291
 7,589,727 B2 9/2009 Haeker
 7,732,687 B2 * 6/2010 Shaffer 84/314 R
 7,875,786 B2 * 1/2011 Hammond 84/477 R
 D649,584 S * 11/2011 Kovaliv D17/20
 D662,540 S * 6/2012 Aikin D17/20
 D668,711 S * 10/2012 Nagels D17/20

D674,000 S * 1/2013 Barbal D17/20
 2002/0178896 A1 12/2002 George
 2005/0172785 A1 8/2005 Fisher-Robbins
 2005/0183567 A1 8/2005 Aoki
 2005/0252359 A1 11/2005 Cook
 2006/0107826 A1 5/2006 Knapp
 2006/0134590 A1 6/2006 Huffman
 2007/0051226 A1 3/2007 Diaz
 2007/0113720 A1 5/2007 Shaffer
 2007/0256540 A1 11/2007 Salter
 2007/0256551 A1 11/2007 Knapp
 2008/0105108 A1 5/2008 Saenz
 2008/0127808 A1 6/2008 Shaffer
 2009/0025535 A1 1/2009 Montgomery
 2009/0064849 A1 3/2009 Festejo
 2009/0126553 A1 5/2009 Murray
 2009/0188371 A1 7/2009 Chiu
 2009/0191932 A1 7/2009 Chiu
 2009/0272248 A1 11/2009 Papenfus
 2009/0314157 A1 12/2009 Sullivan
 2010/0031804 A1 2/2010 Chevreau
 2010/0137049 A1 6/2010 Epstein
 2011/0003638 A1 1/2011 Lee
 2011/0011241 A1 1/2011 Bartos
 2011/0218022 A1 9/2011 Chiu
 2011/0319160 A1 12/2011 Arn
 2012/0064498 A1 3/2012 Swain

* cited by examiner

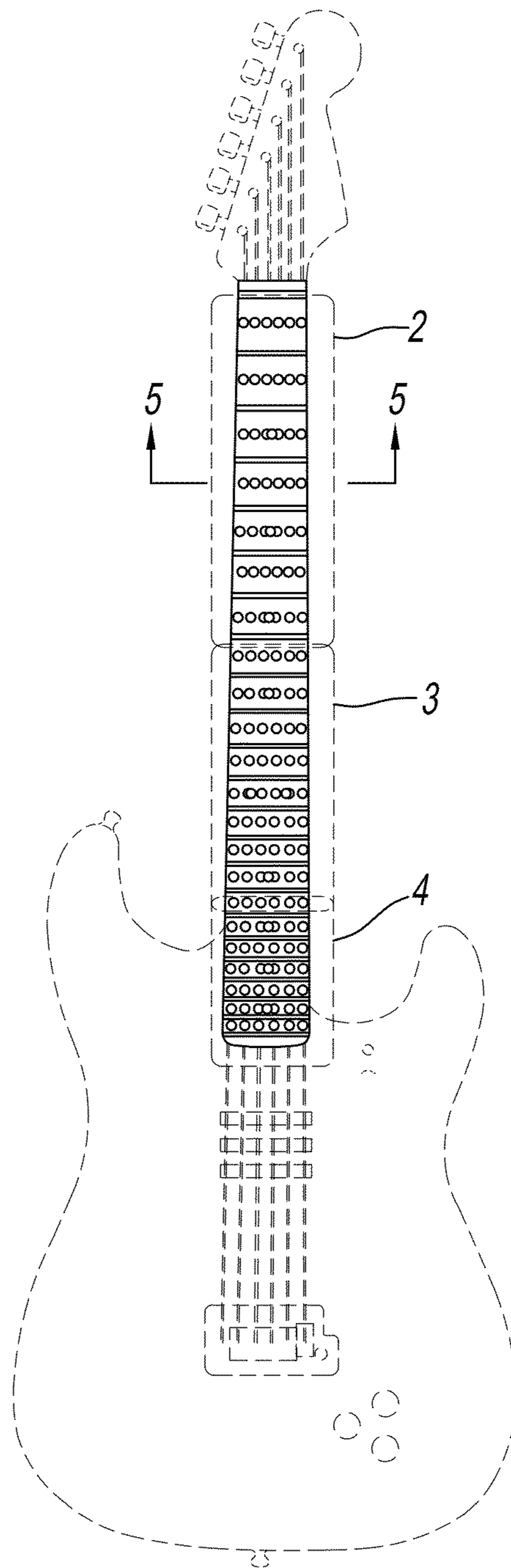

FIG. 1

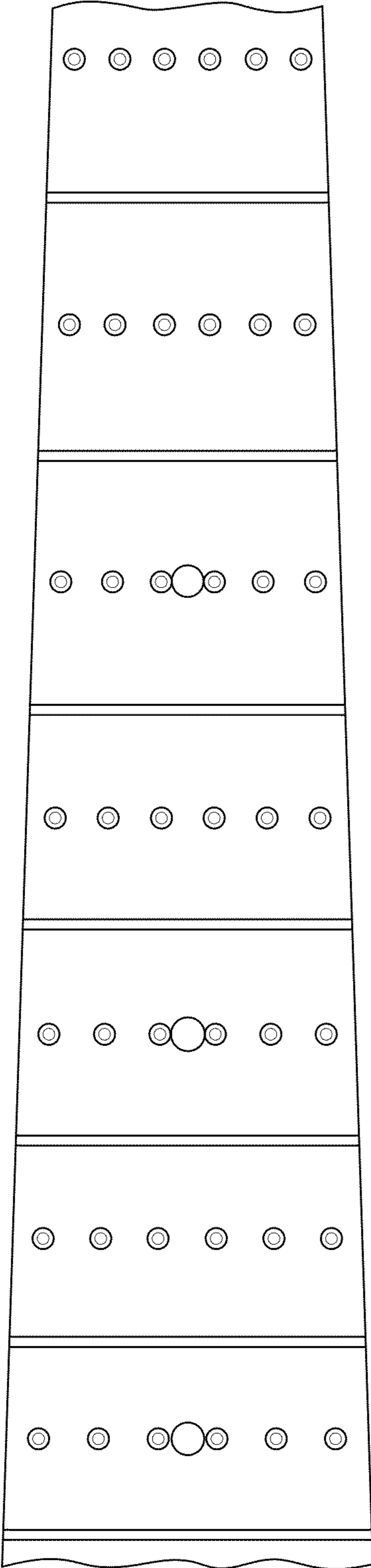

FIG. 2

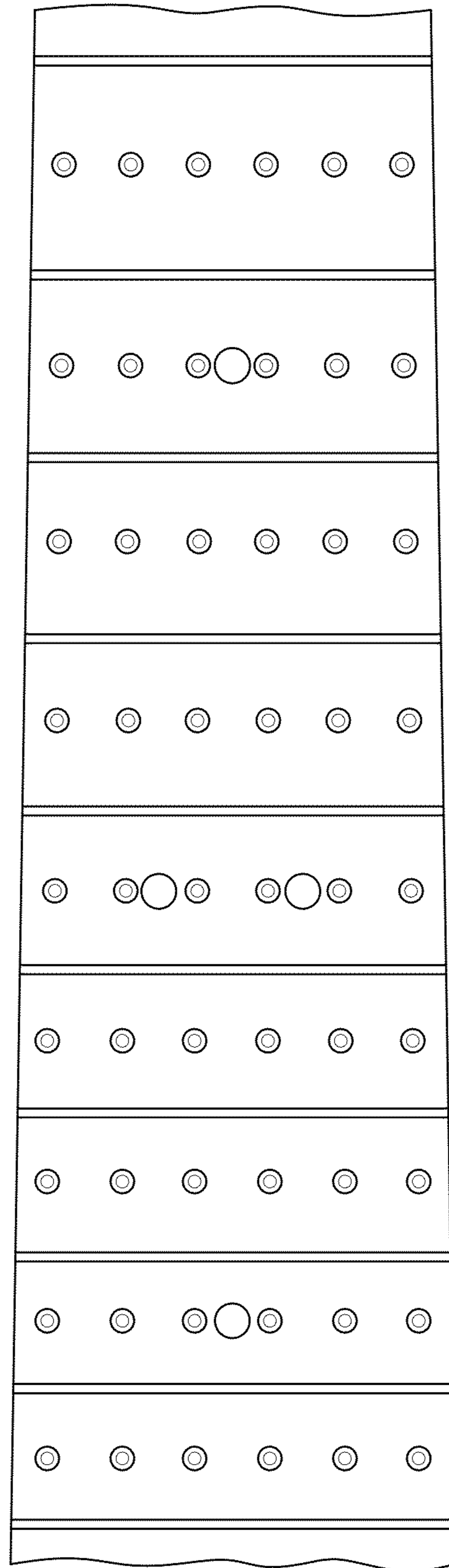

FIG. 3

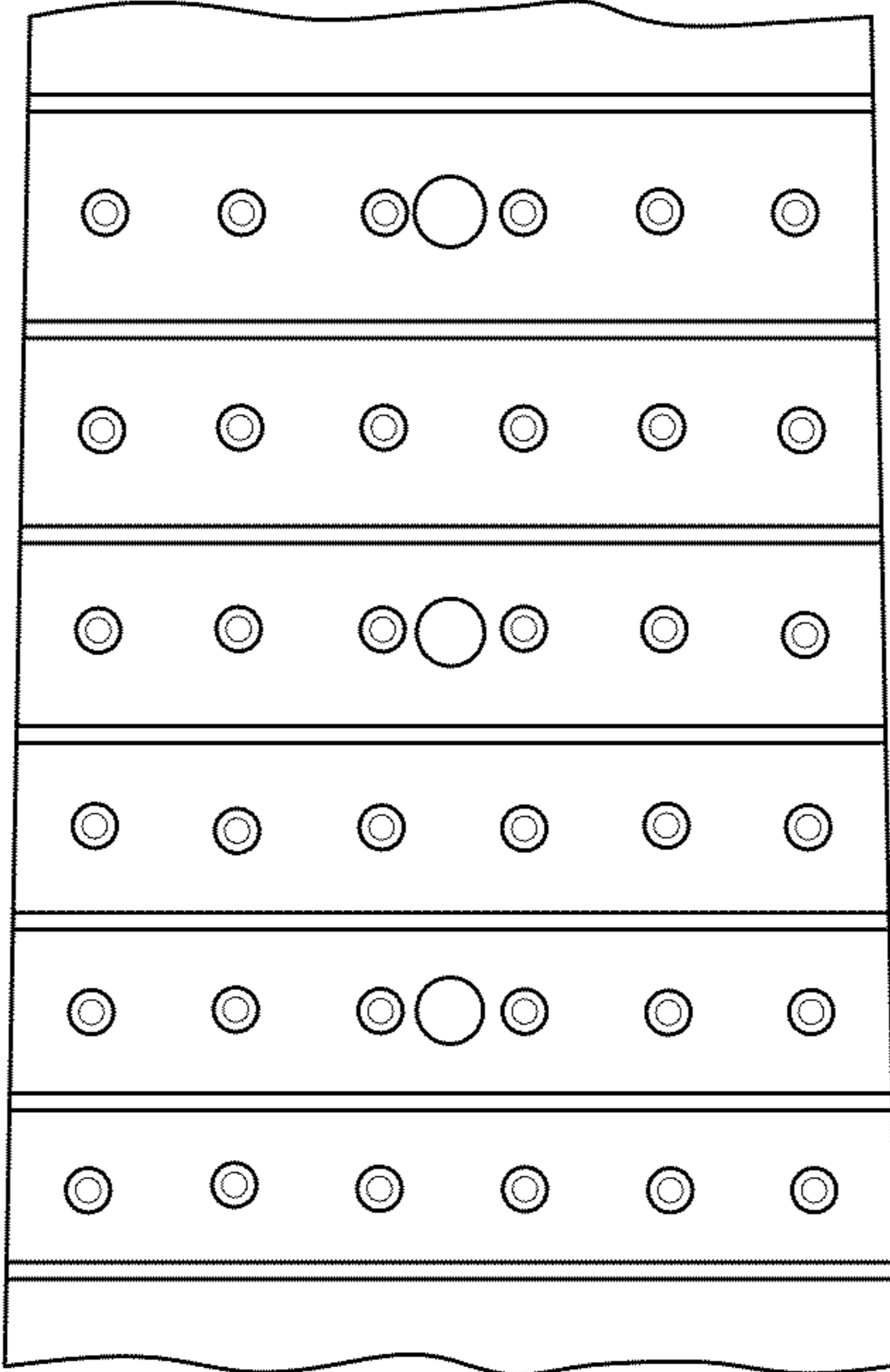

FIG. 4

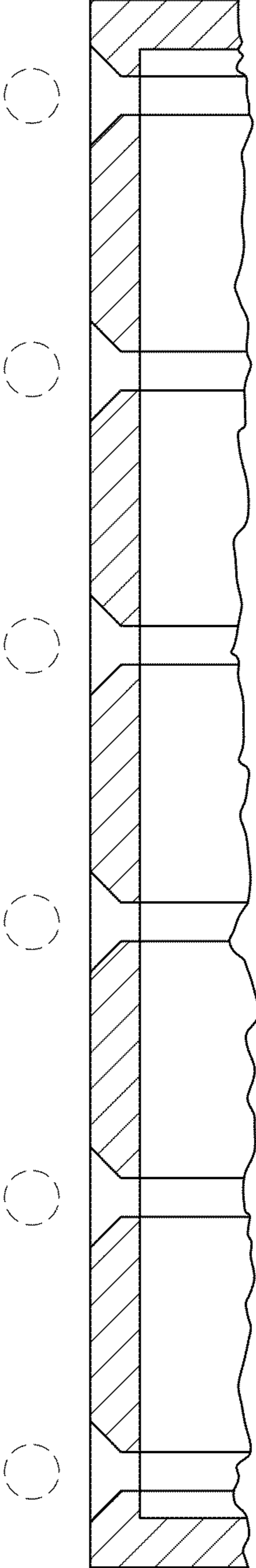

FIG. 5

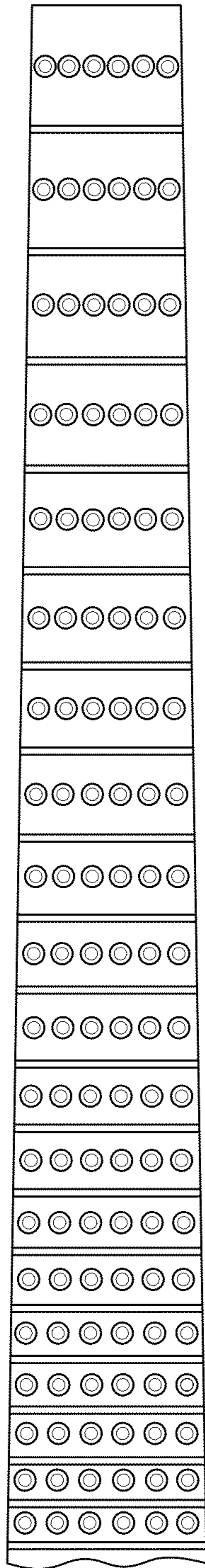

FIG. 6



FIG. 7