



US00D757294S

(12) **United States Design Patent**  
**Pearson et al.**

(10) **Patent No.:** **US D757,294 S**  
(45) **Date of Patent:** **\*\* May 24, 2016**

(54) **FEMALE SEXUAL STIMULATION DEVICE**  
(71) Applicants: **Christine Pearson**, Orlando, FL (US);  
**Ralph Cuccuro, Jr.**, Orlando, FL (US)  
(72) Inventors: **Christine Pearson**, Orlando, FL (US);  
**Ralph Cuccuro, Jr.**, Orlando, FL (US)  
(\*\*) Term: **15 Years**  
(21) Appl. No.: **29/531,679**  
(22) Filed: **Jun. 29, 2015**  
(51) **LOC (10) Cl.** ..... **28-03**  
(52) **U.S. Cl.**  
USPC ..... **D24/215**  
(58) **Field of Classification Search**  
USPC ..... D24/200, 211, 212, 213, 214, 215,  
D24/189-193; 601/19, 27-33, 38, 46, 52,  
601/112, 118, DIG. 12, DIG. 14, DIG. 1,  
601/DIG. 16, DIG. 17; D30/160  
CPC ..... A61H 2201/0153; A61H 2201/0207;  
A61H 2201/0263; A61H 2201/0111; A61H  
2201/1253; A61H 2205/082; A61H 2205/085;  
A61H 15/0085; A61H 19/00; A61H 19/30;  
A61H 19/32; A61H 19/40; A61H 19/44;  
A61H 19/50  
See application file for complete search history.

D592,758 S \* 5/2009 Kain ..... D24/215  
7,530,944 B1 \* 5/2009 Kain ..... A61H 19/34  
600/38  
D603,052 S \* 10/2009 Bauer ..... D24/214  
D604,425 S \* 11/2009 Stewart ..... D24/214  
D626,248 S \* 10/2010 Gotzen ..... D24/215  
7,998,057 B2 \* 8/2011 Kain ..... A61H 19/44  
600/38  
8,062,208 B1 \* 11/2011 Cannon ..... A61H 19/44  
600/38  
D652,942 S \* 1/2012 Murison ..... D24/215  
D688,383 S \* 8/2013 Manabe ..... D24/215  
D712,059 S \* 8/2014 Sedic ..... D24/215  
D718,870 S \* 12/2014 Hildebrand ..... D24/211  
D723,179 S \* 2/2015 Elliott ..... D24/215  
D727,525 S \* 4/2015 Qian ..... D24/215  
D732,183 S \* 6/2015 Imboden ..... D24/215  
D737,457 S \* 8/2015 Cai ..... D24/215

\* cited by examiner

*Primary Examiner* — Sandra Snapp  
(74) *Attorney, Agent, or Firm* — Jason T. Daniel, Esq.;  
Daniel Law Offices, P.A.

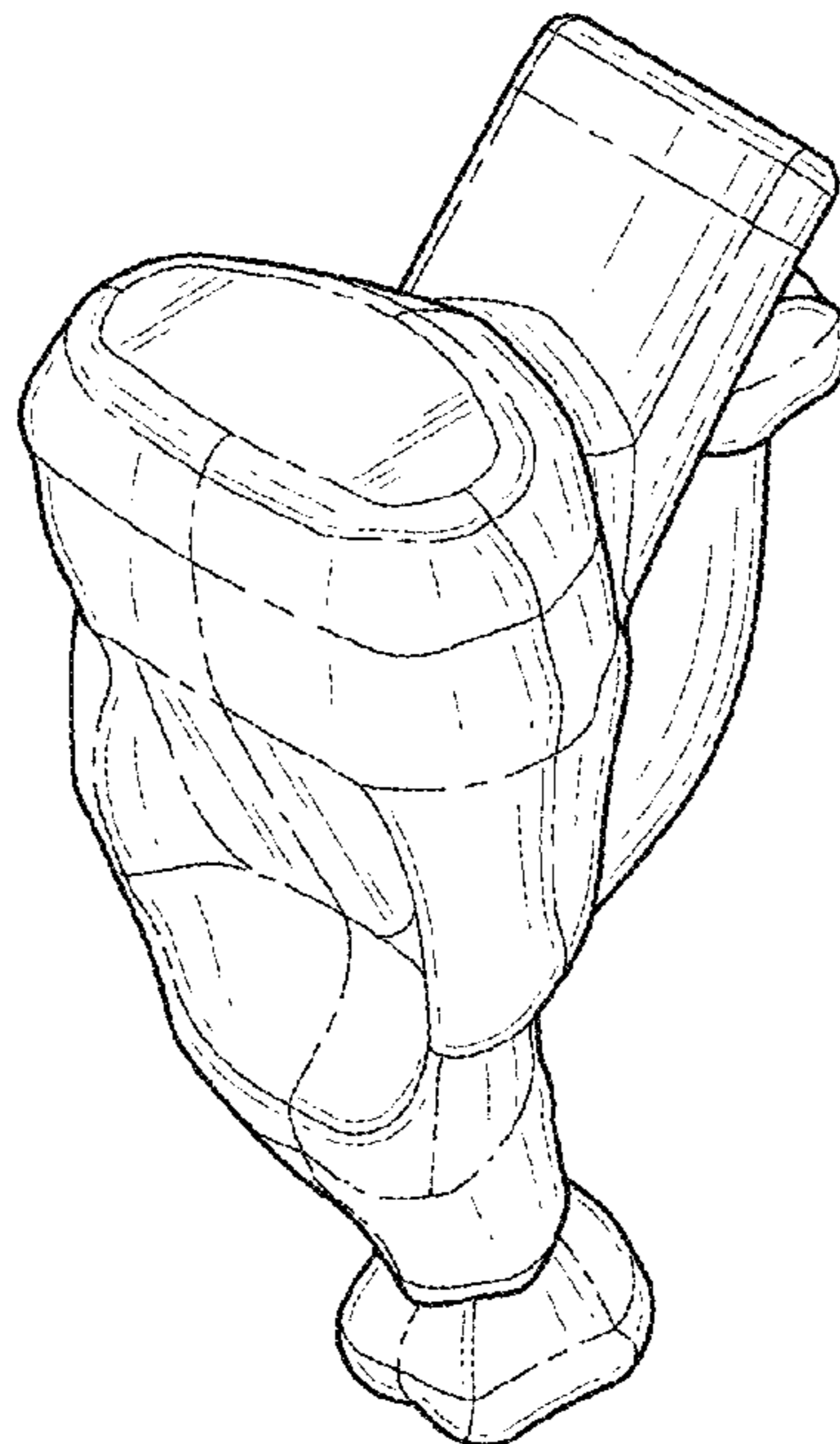
(57) **CLAIM**  
The ornamental design for a female sexual stimulation  
device, as shown and described.

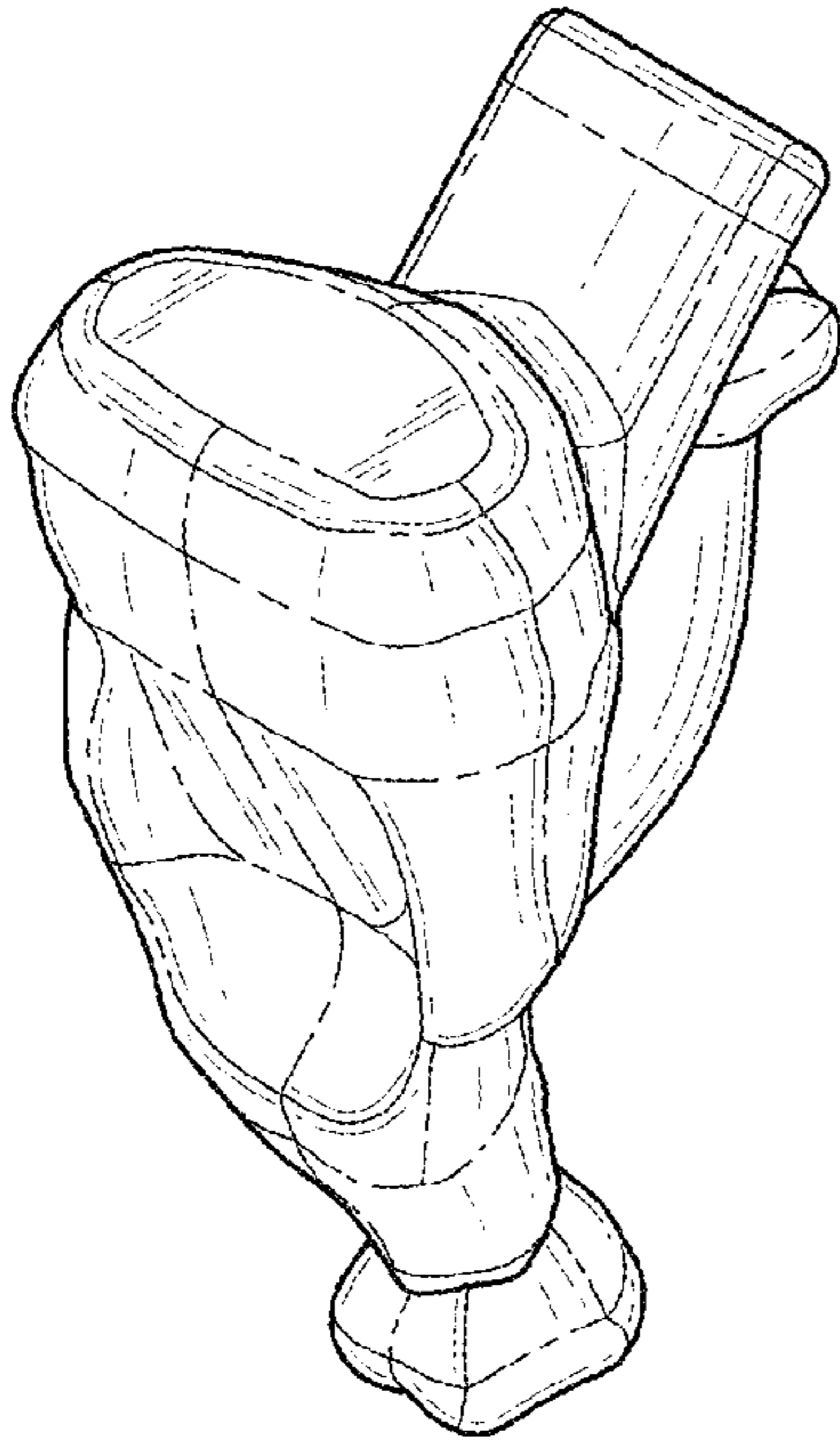
**DESCRIPTION**

FIG. 1 is a perspective view thereof,  
FIG. 2 is a top side view thereof,  
FIG. 3 is a bottom side view thereof,  
FIG. 4 is a right side view thereof,  
FIG. 5 is a left side view thereof,  
FIG. 6 is a front side view thereof; and,  
FIG. 7 is a back side view thereof.

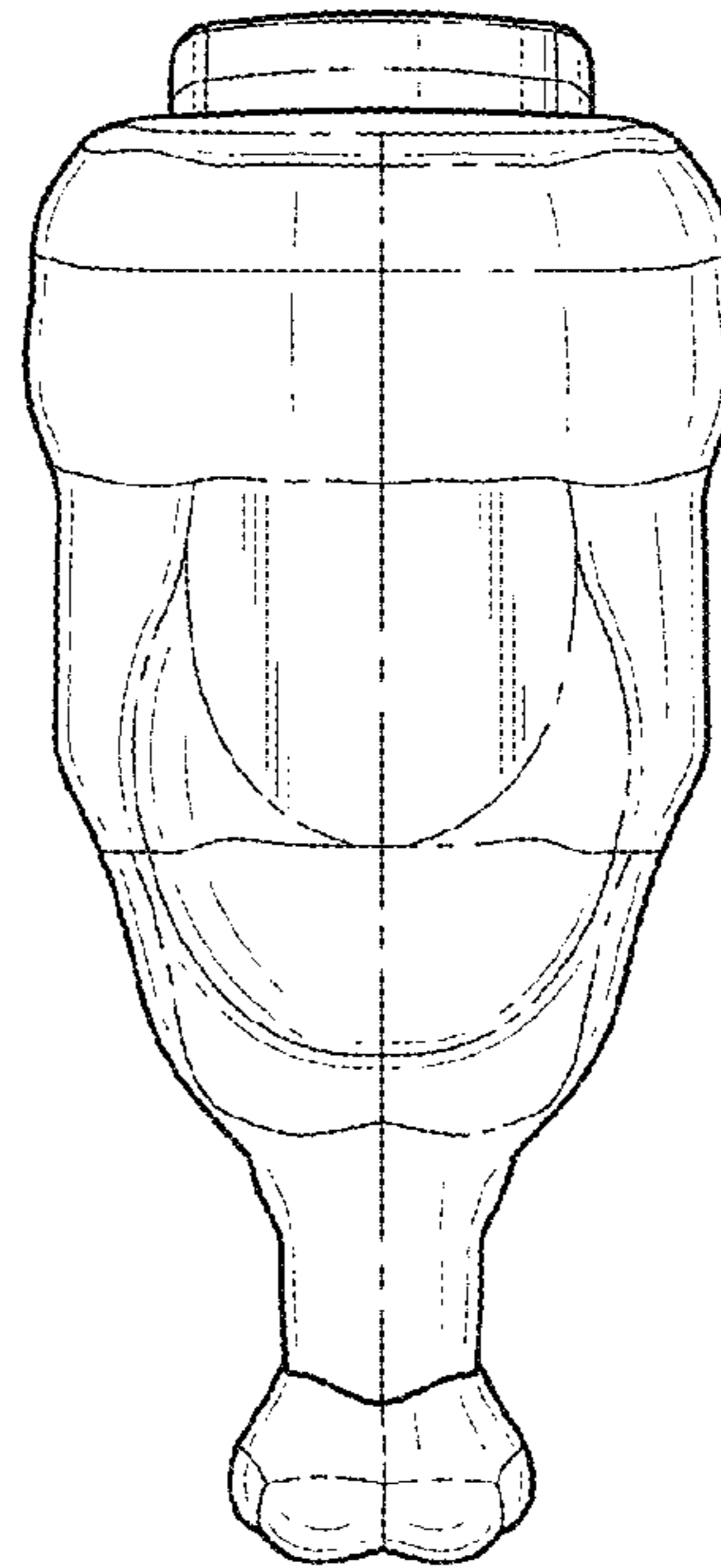
**1 Claim, 2 Drawing Sheets**

(56) **References Cited**  
U.S. PATENT DOCUMENTS  
D320,087 S \* 9/1991 Sholzberg ..... D24/215  
5,624,385 A \* 4/1997 Hwang ..... A61J 7/003  
601/135  
D384,156 S \* 9/1997 Kain ..... D24/200  
5,690,603 A \* 11/1997 Kain ..... A61H 19/34  
600/38

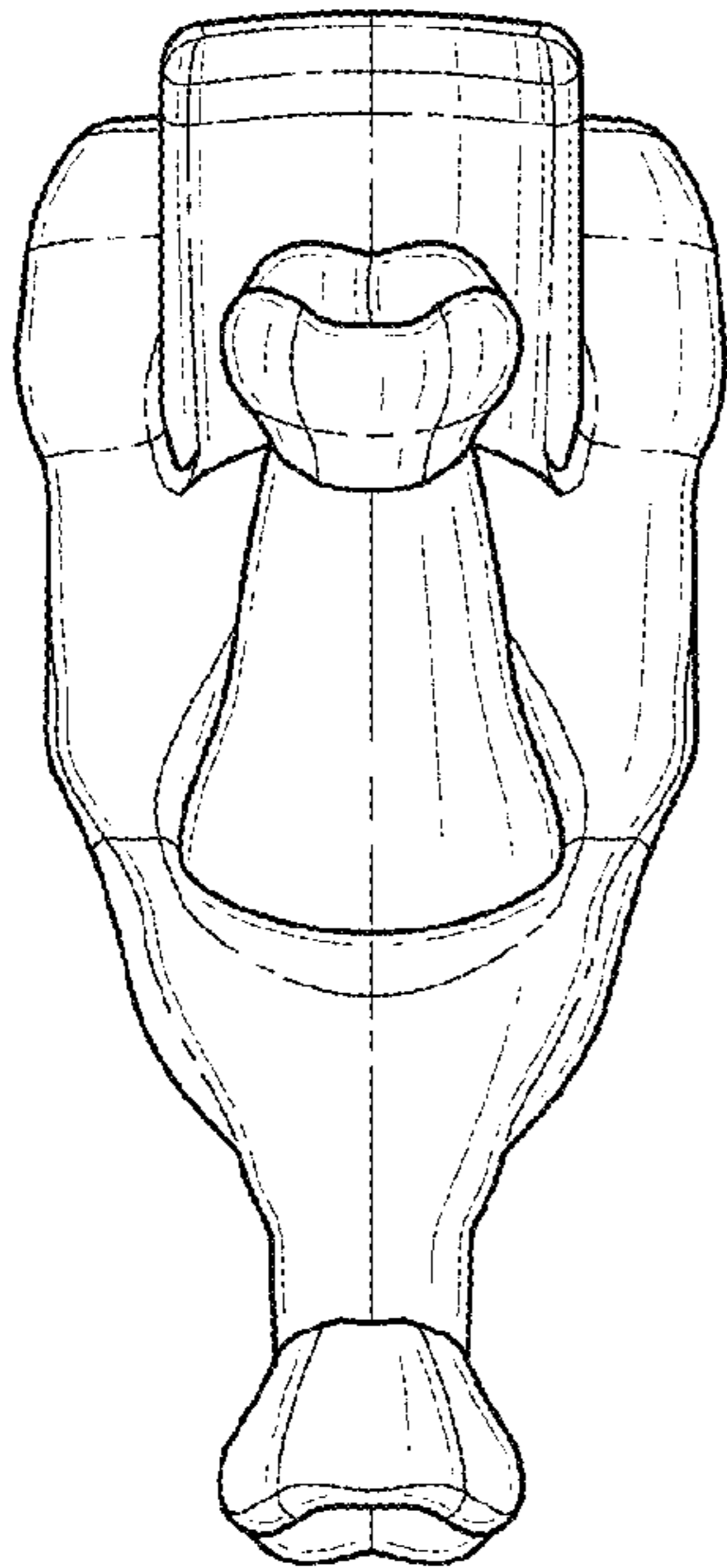




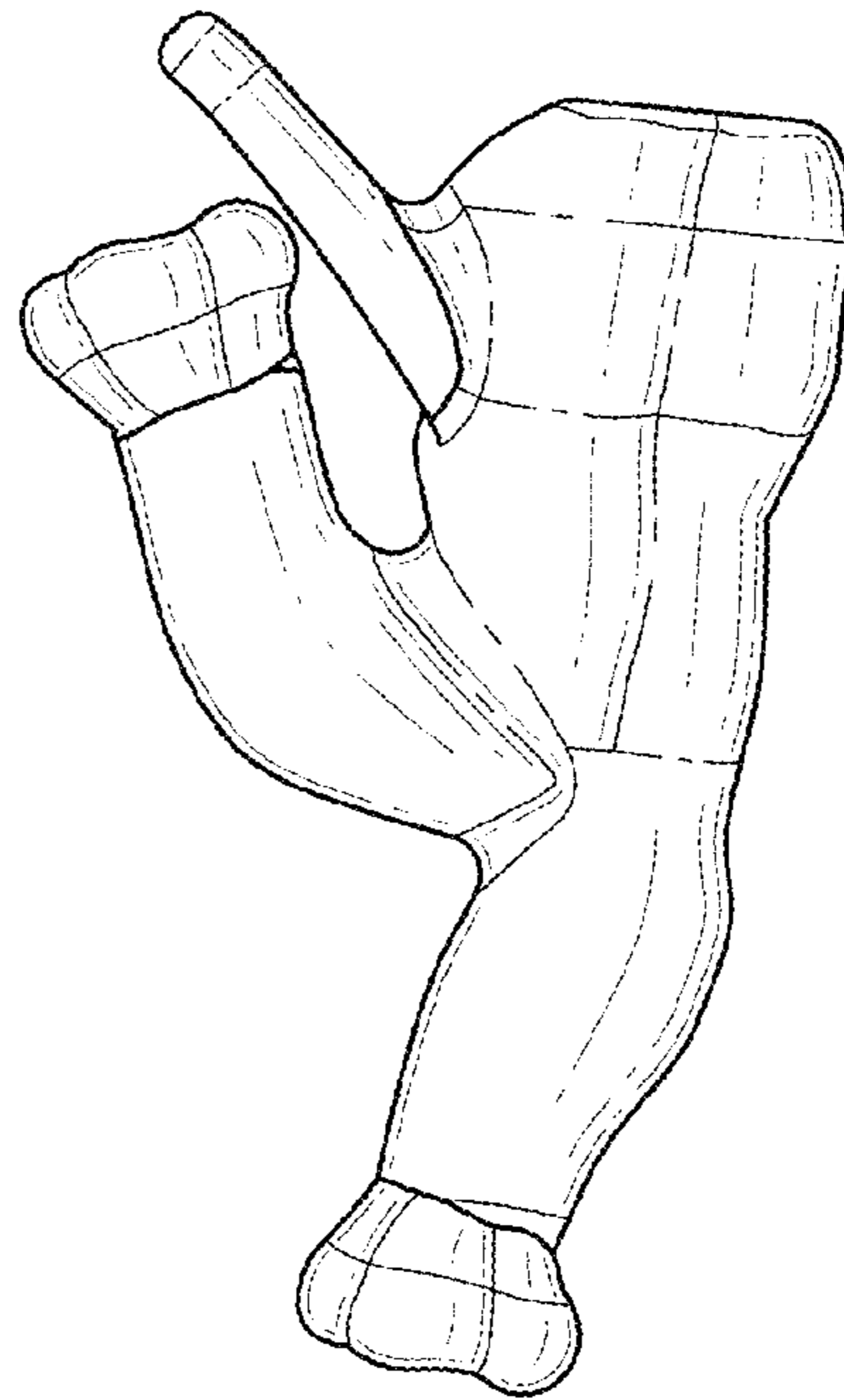
*FIG. 1*



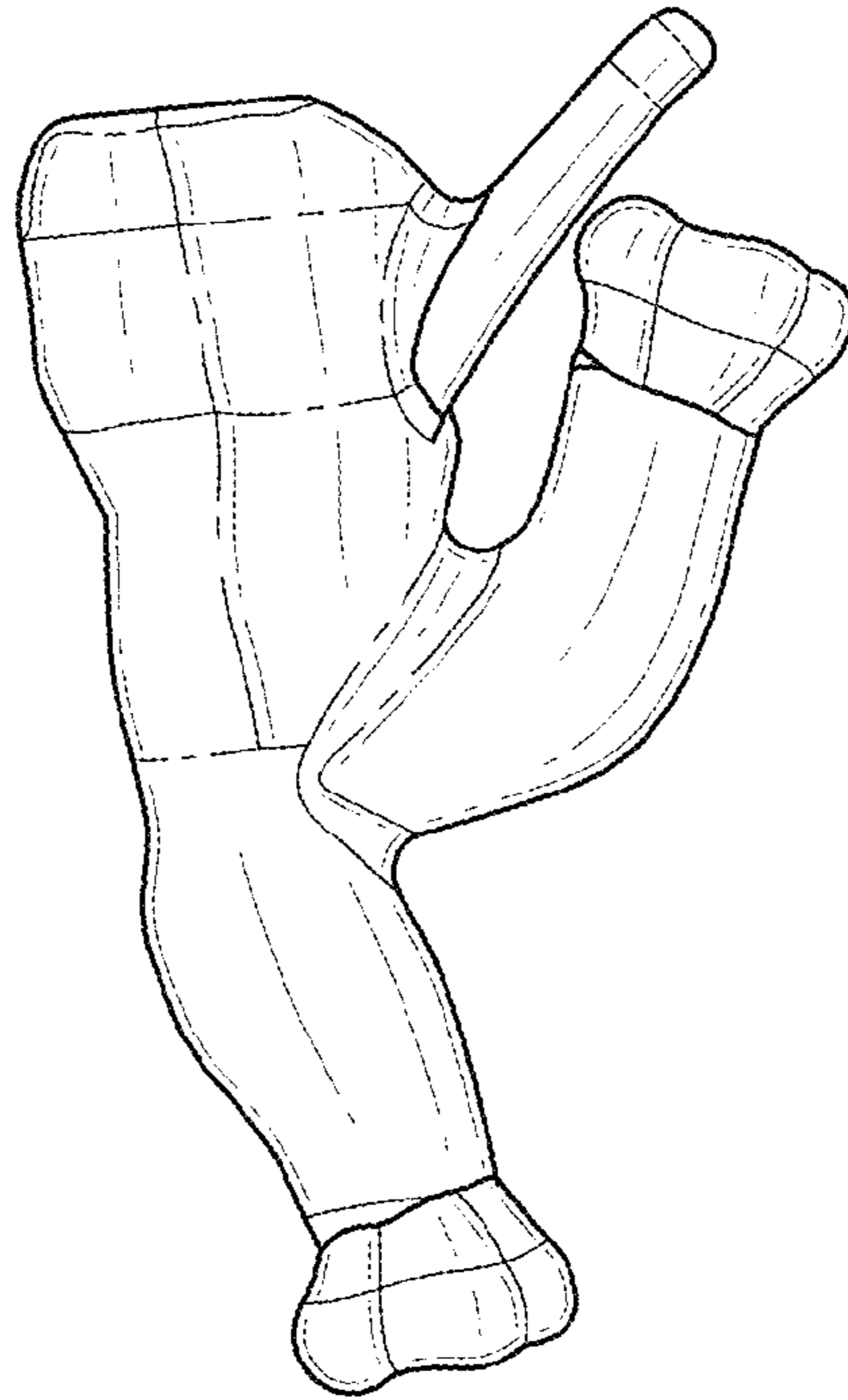
*FIG. 2*



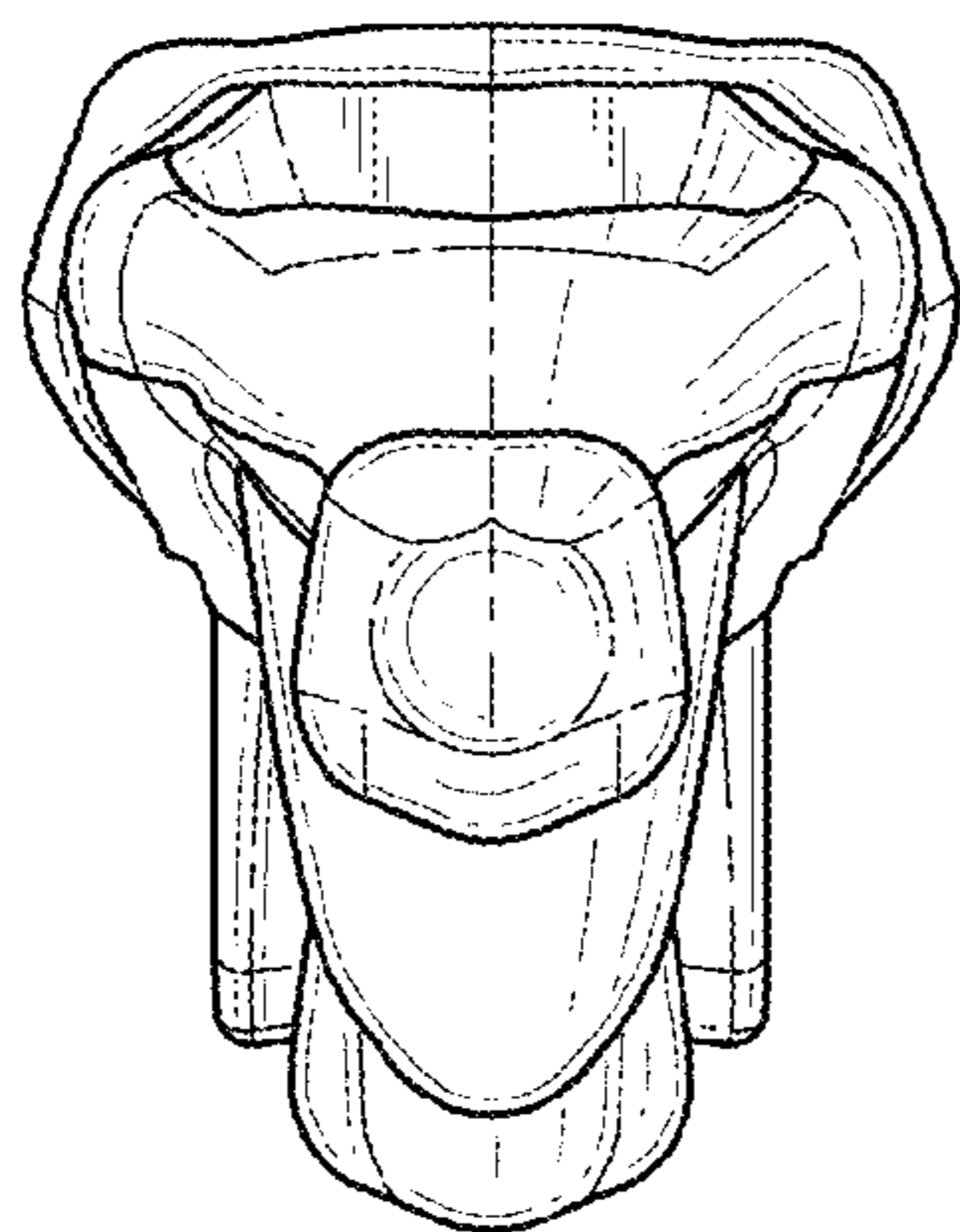
*FIG. 3*



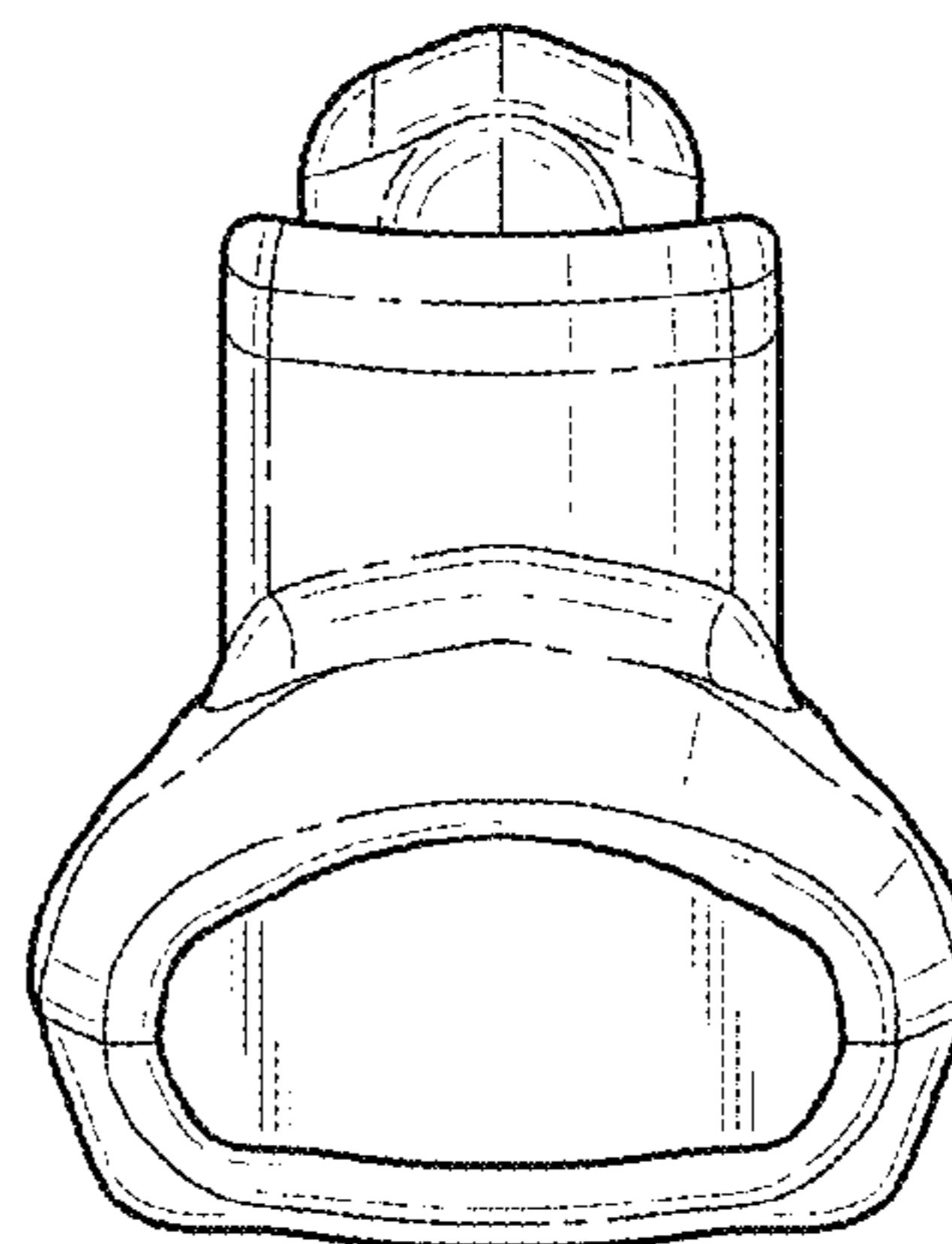
*FIG. 4*



*FIG. 5*



*FIG. 6*



*FIG. 7*