

US00D757293S

(12) **United States Design Patent**
Pearson et al.

(10) **Patent No.:** **US D757,293 S**
(45) **Date of Patent:** **** May 24, 2016**

(54) **FEMALE SEXUAL STIMULATION DEVICE**
(71) Applicants: **Christine Pearson**, Orlando, FL (US);
Ralph Cuccuro, Jr., Orlando, FL (US)
(72) Inventors: **Christine Pearson**, Orlando, FL (US);
Ralph Cuccuro, Jr., Orlando, FL (US)
(**) Term: **15 Years**
(21) Appl. No.: **29/531,674**
(22) Filed: **Jun. 29, 2015**
(51) **LOC (10) Cl.** **28-03**
(52) **U.S. Cl.**
USPC **D24/215**
(58) **Field of Classification Search**
USPC D24/200, 211, 212, 213, 214, 215,
D24/189-193; 601/19, 27-33, 38, 46, 52,
601/112, 118, DIG. 12, DIG. 14, DIG. 1,
601/DIG. 16, DIG. 175; D30/160
CPC A61H 2201/0153; A61H 2201/0207;
A61H 2201/0263; A61H 2201/0111; A61H
2201/1253; A61H 2205/082; A61H 2205/085;
A61H 15/0085; A61H 19/00; A61H 19/30;
A61H 19/32; A61H 19/40; A61H 19/44;
A61H 19/50
See application file for complete search history.

D592,758 S * 5/2009 Kain D24/215
7,530,944 B1 * 5/2009 Kain A61H 19/34
600/38
D603,052 S * 10/2009 Bauer D24/214
D604,425 S * 11/2009 Stewart D24/214
D626,248 S * 10/2010 Gotzen D24/215
7,998,057 B2 * 8/2011 Kain A61H 19/44
600/38
8,062,208 B1 * 11/2011 Cannon A61H 19/44
600/38
D652,942 S * 1/2012 Murison D24/215
D688,383 S * 8/2013 Manabe D24/215
D712,059 S * 8/2014 Sedic D24/215
D718,870 S * 12/2014 Hildebrand D24/211
D723,179 S * 2/2015 Elliott D24/215
D727,525 S * 4/2015 Qian D24/215
D732,183 S * 6/2015 Imboden D24/215
D737,457 S * 8/2015 Cai D24/215

* cited by examiner

Primary Examiner — Sandra Snapp
(74) *Attorney, Agent, or Firm* — Jason T. Daniel; Daniel Law
Offices, P.A.

(57) **CLAIM**
The ornamental design for a female sexual stimulation
device, as shown and described.

DESCRIPTION

FIG. 1 is a perspective view thereof,
FIG. 2 is a top side view thereof,
FIG. 3 is a bottom side view thereof,
FIG. 4 is a right side view thereof,
FIG. 5 is a left side view thereof,
FIG. 6 is a front side view thereof; and,
FIG. 7 is a back side view thereof.

1 Claim, 2 Drawing Sheets

(56) **References Cited**
U.S. PATENT DOCUMENTS
D320,087 S * 9/1991 Sholzberg D24/215
5,624,385 A * 4/1997 Hwang A61H 7/003
601/135
D384,156 S * 9/1997 Kain D24/200
5,690,603 A * 11/1997 Kain A61H 19/34
600/38

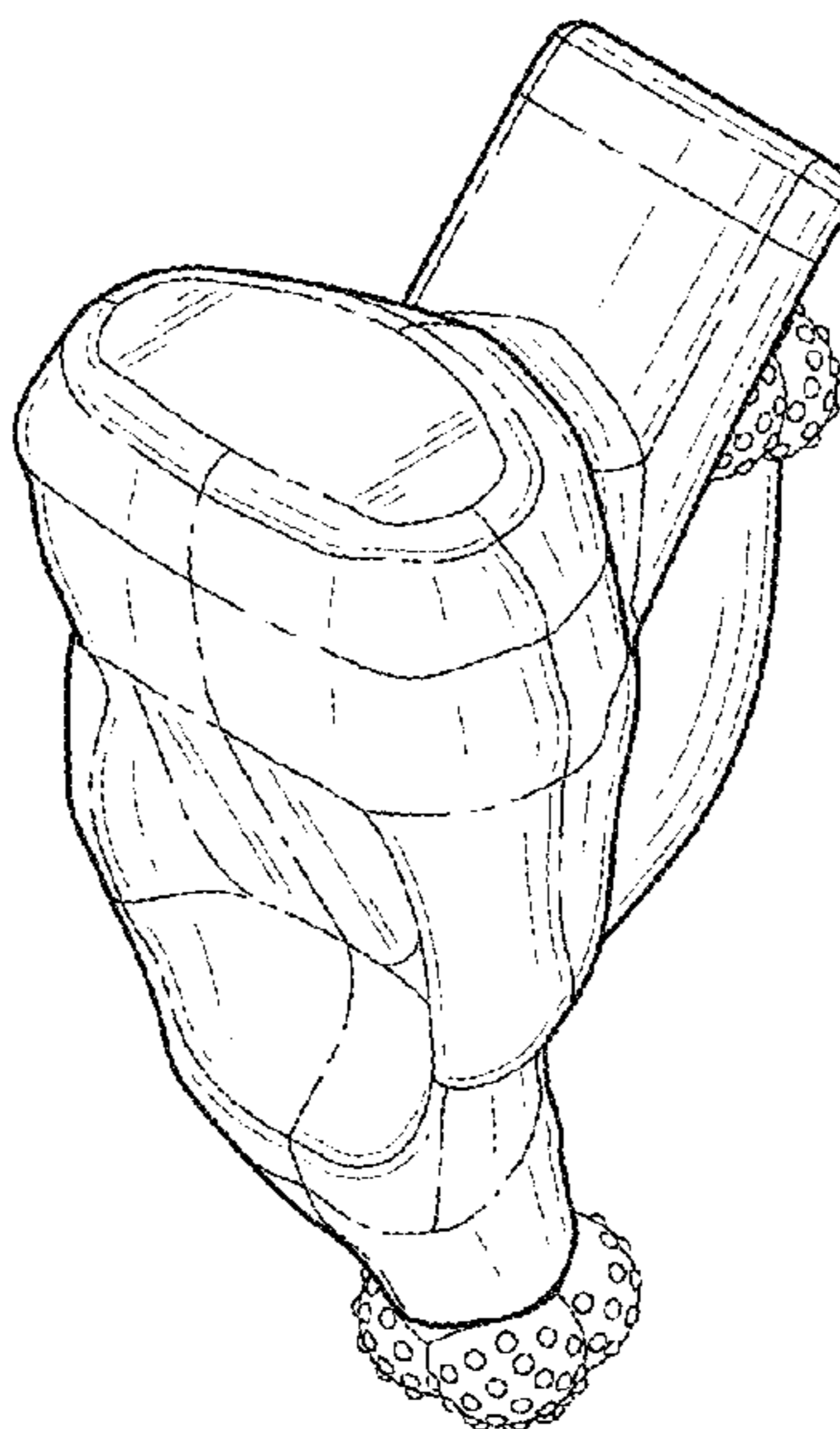

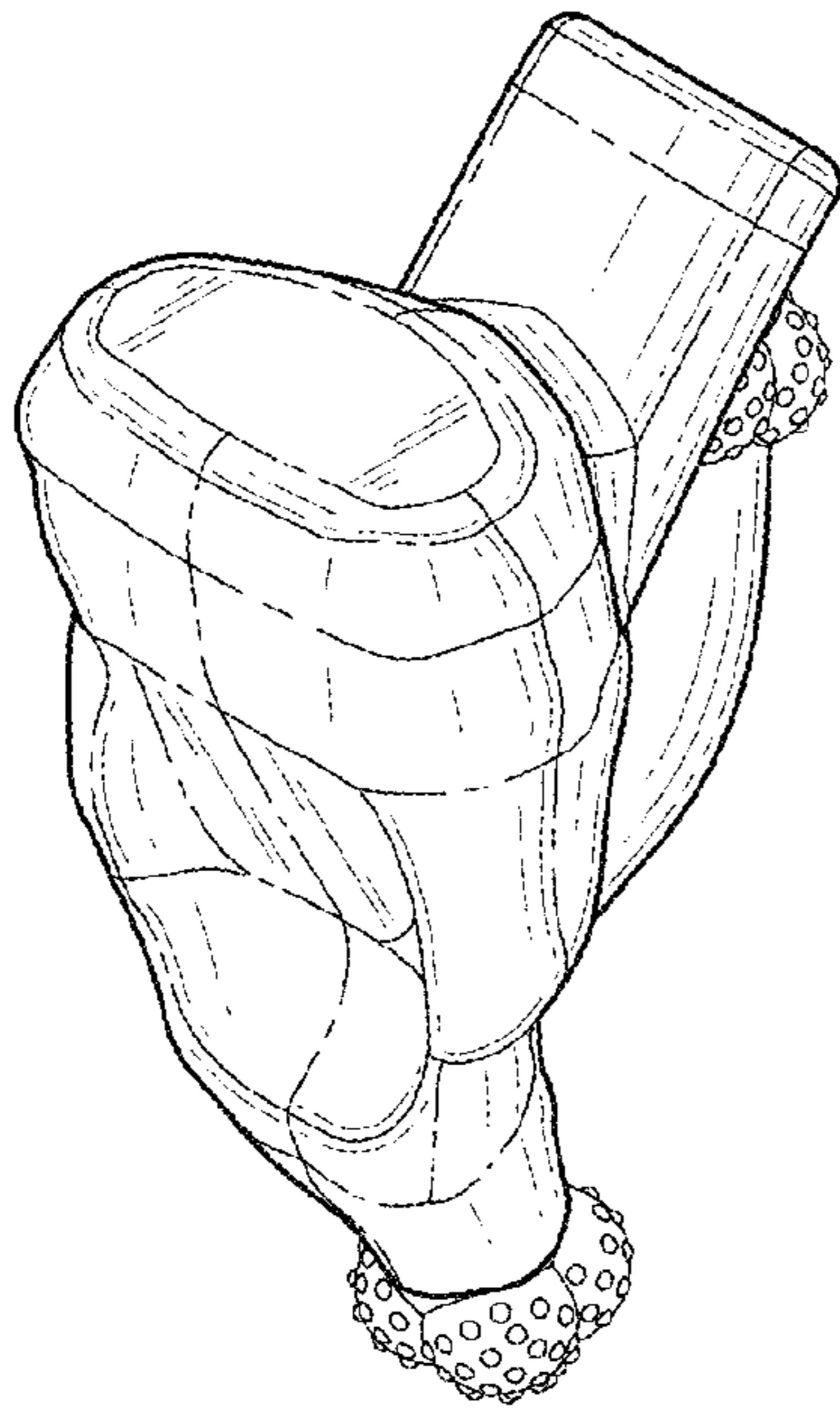

FIG. 1

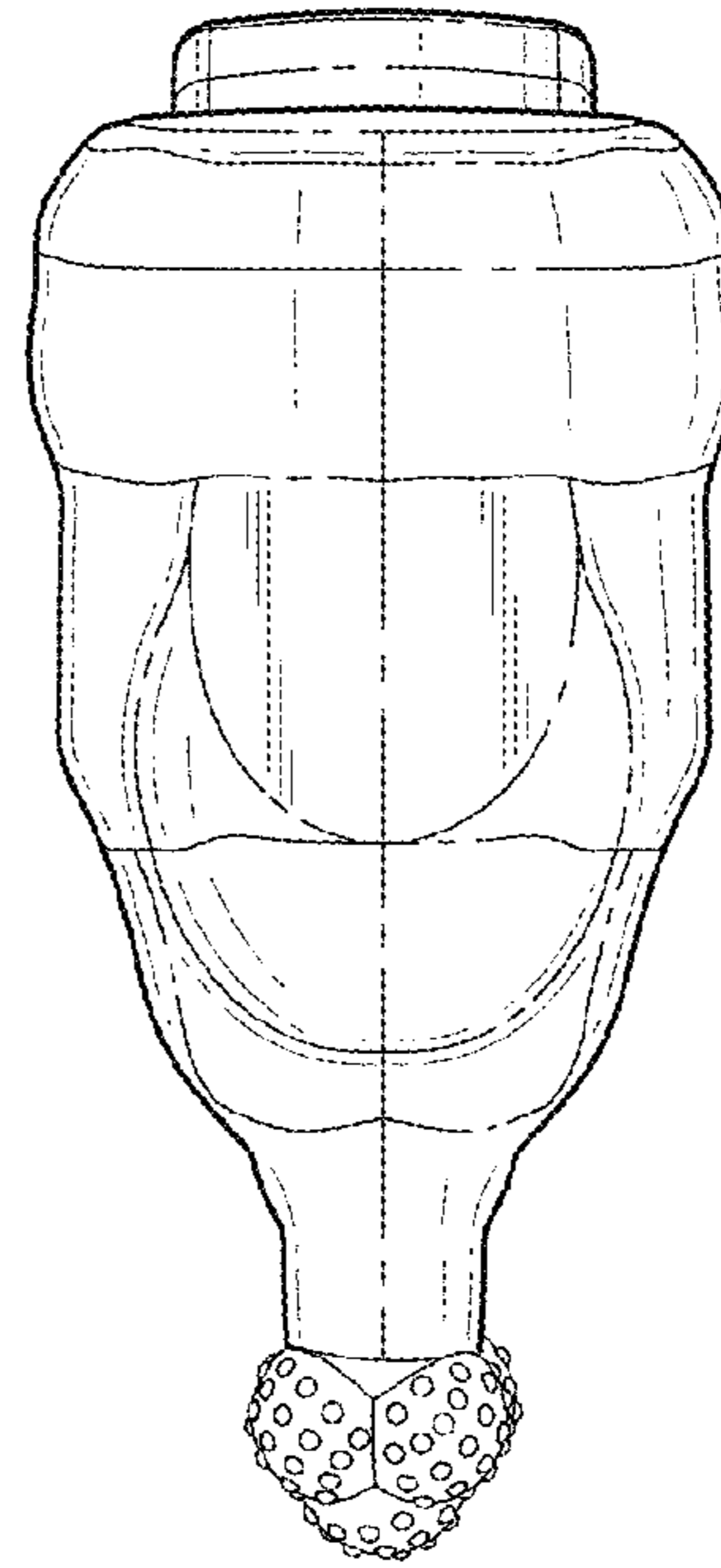

FIG. 2

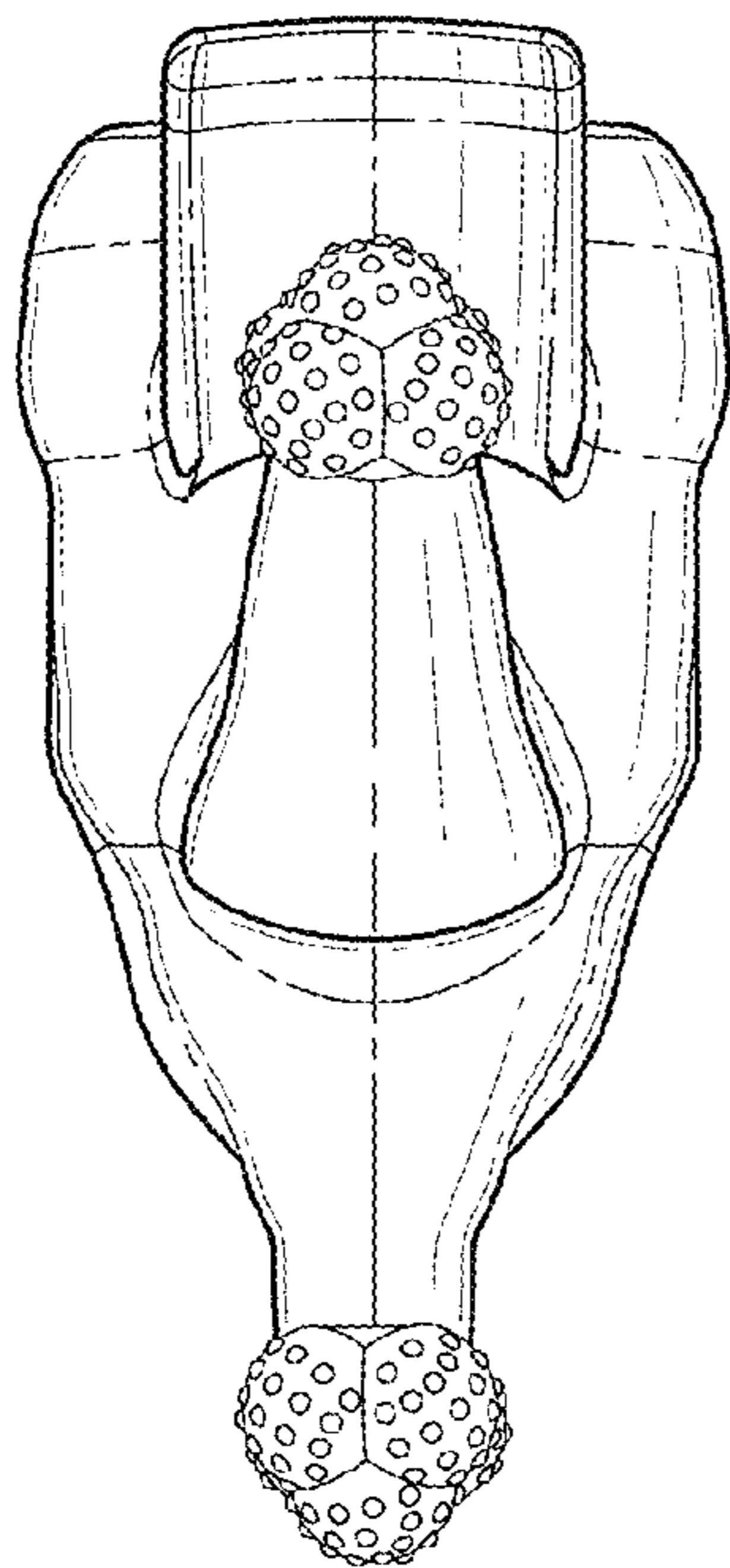

FIG. 3

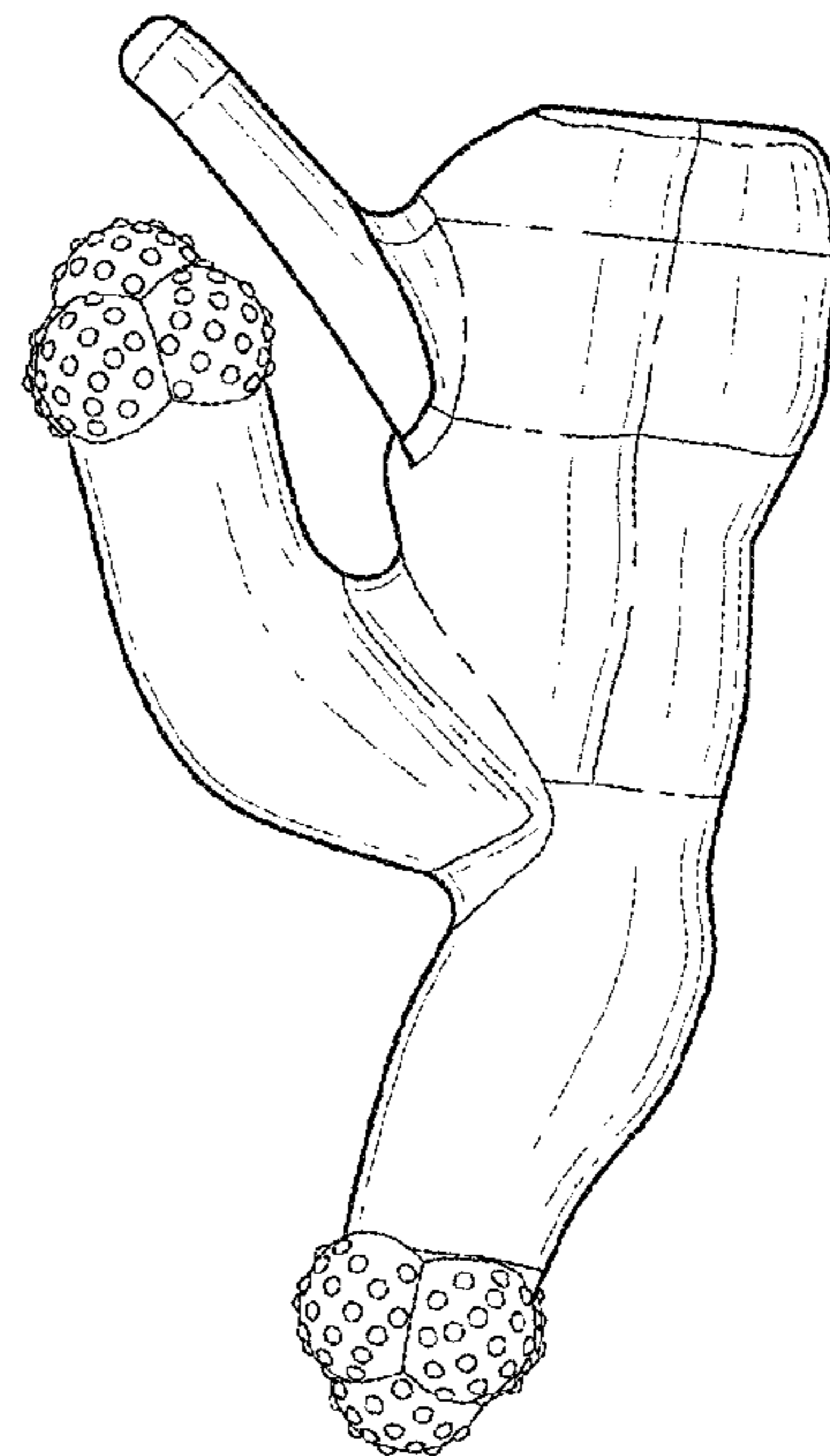

FIG. 4

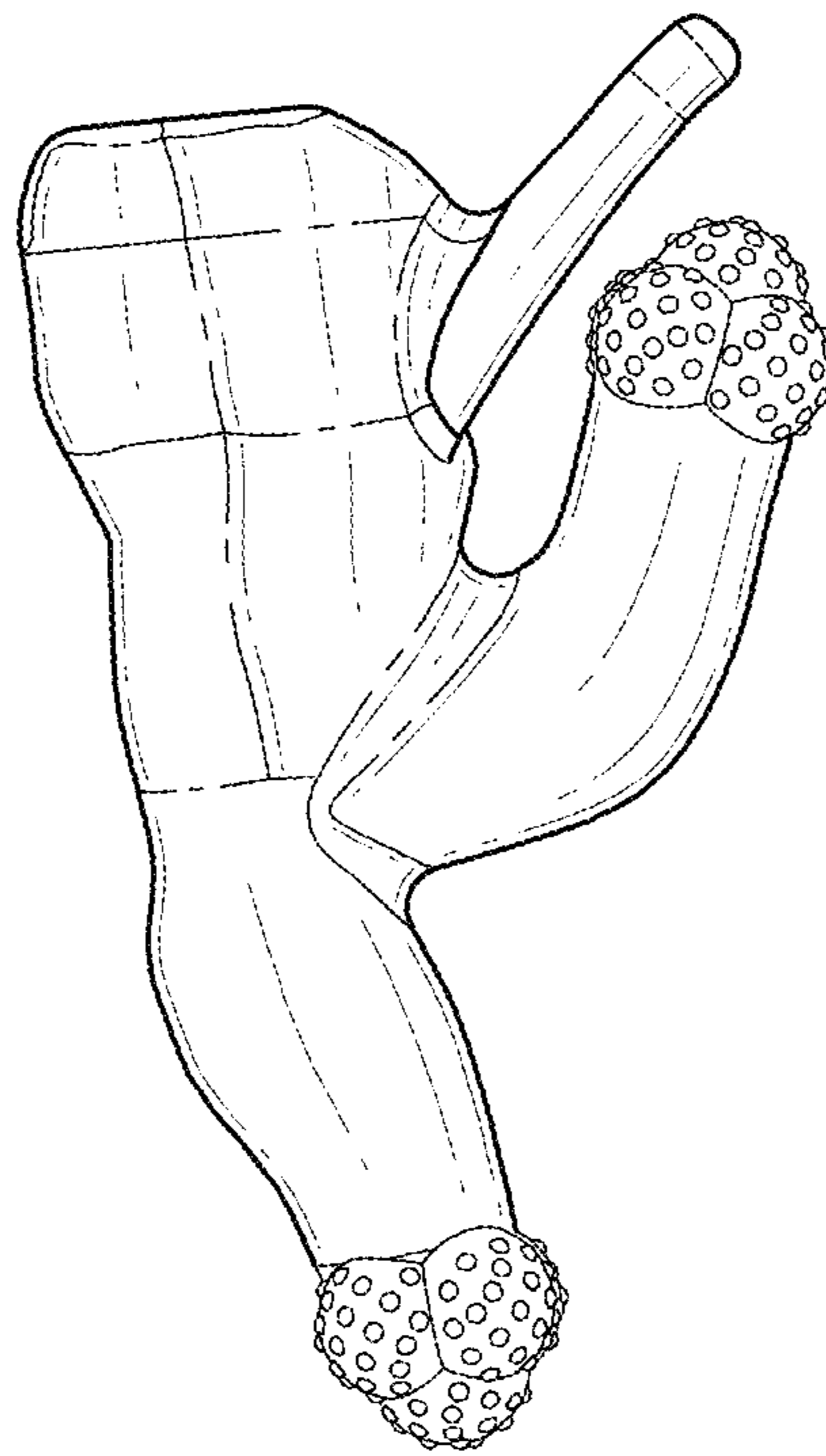

FIG. 5

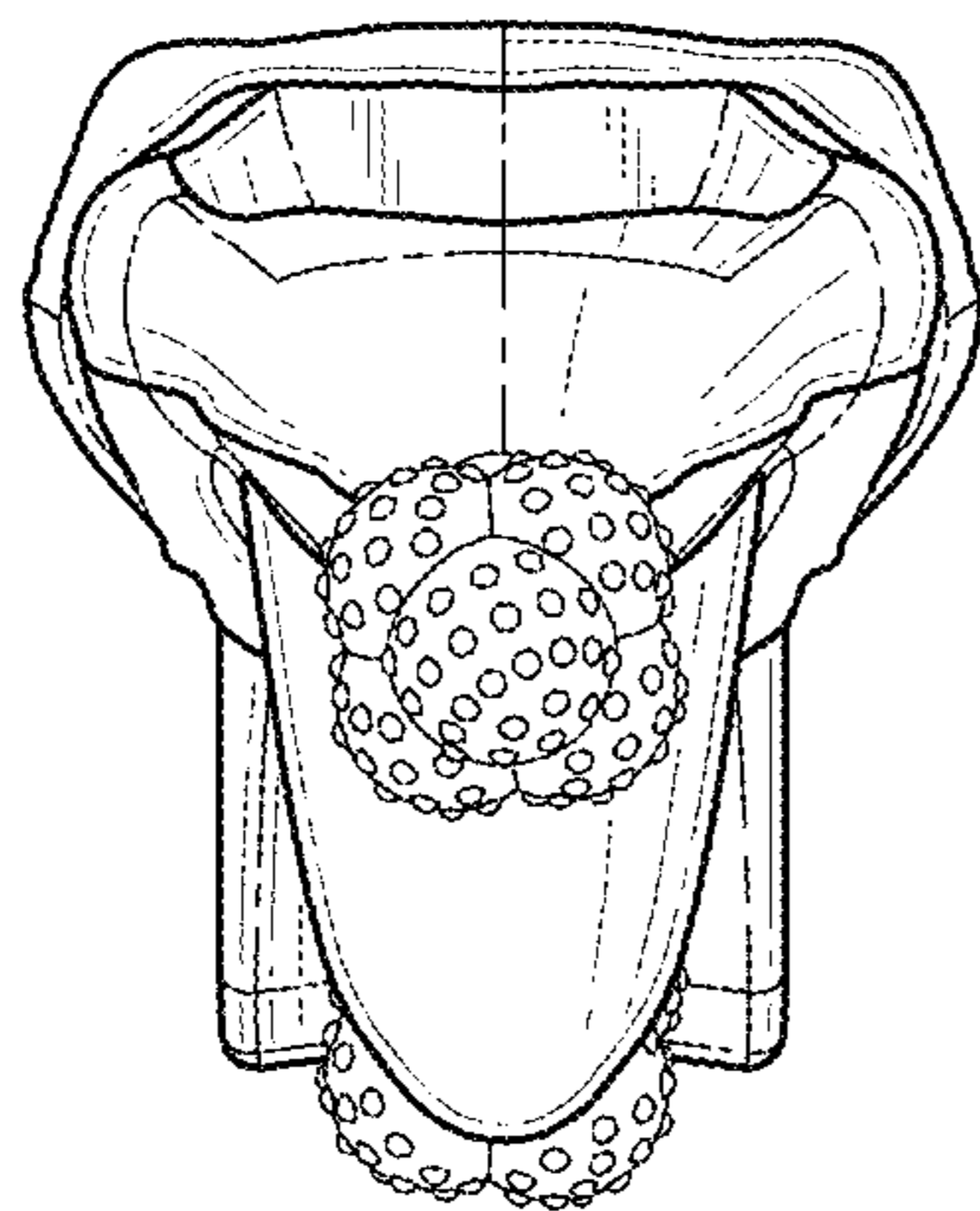

FIG. 6

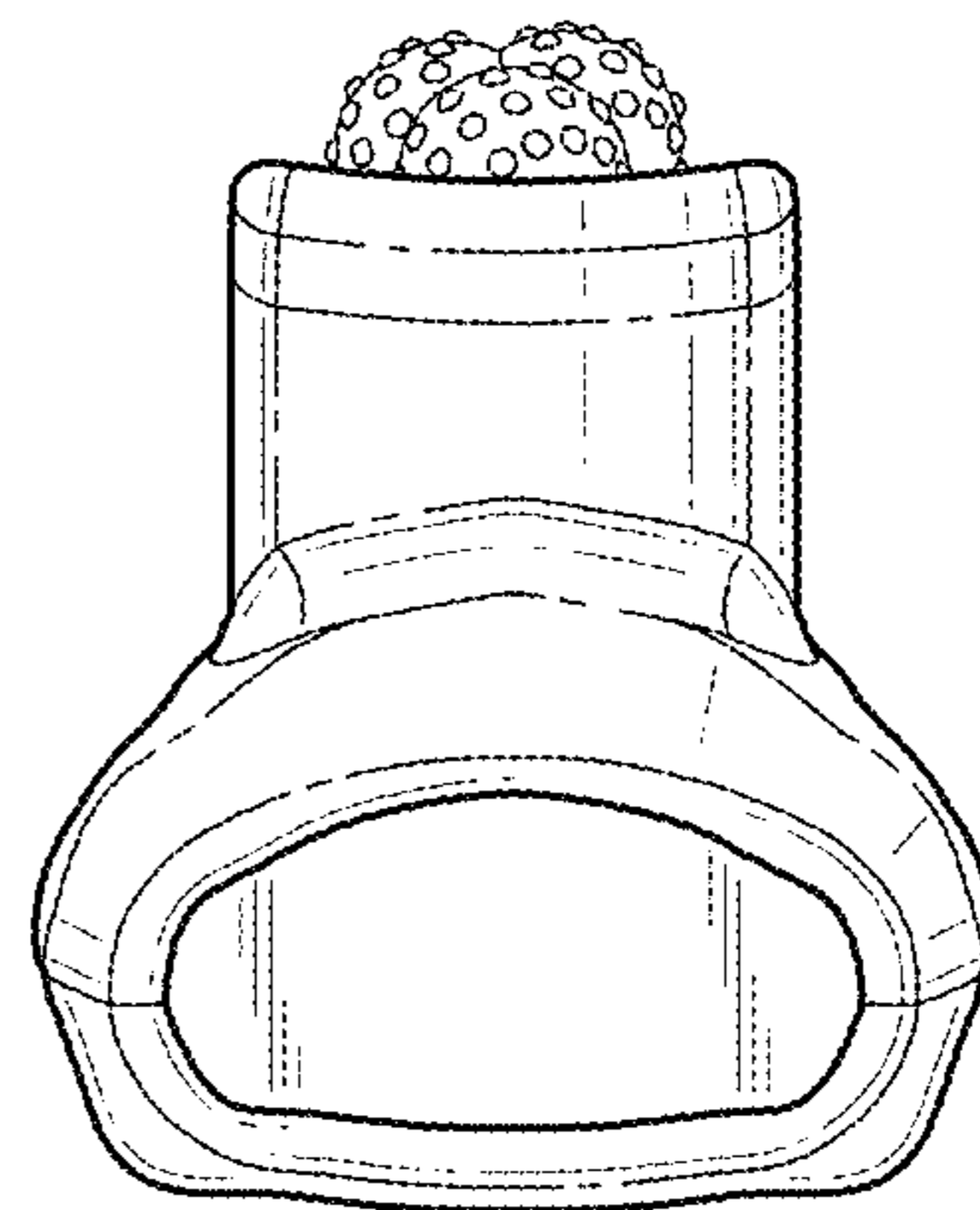

FIG. 7