



US00D757257S

(12) **United States Design Patent**
Grossman

(10) **Patent No.:** **US D757,257 S**

(45) **Date of Patent:** **** May 24, 2016**

(54) **URINARY ASSISTANCE DEVICE**

(71) Applicant: **Stand Up Life LLC**, San Francisco, CA (US)

(72) Inventor: **Sara Grossman**, San Francisco, CA (US)

(73) Assignee: **STAND UP LIFE LLC**, San Francisco, CA (US)

(**) Term: **14 Years**

(21) Appl. No.: **29/521,472**

(22) Filed: **Mar. 24, 2015**

(51) **LOC (10) Cl.** **24-04**

(52) **U.S. Cl.**
USPC **D24/122**

(58) **Field of Classification Search**

USPC D24/121–123, 112, 207, 216, 224;
D9/716, 524, 435, 441, 447, 431;
D7/509–511, 309, 305, 900, 538, 539,
D7/321, 700; 600/573, 574; 604/317, 318,
604/334; D23/274, 302, 295, 309, 200;
4/144.1–144.4, 459, 460; 229/138
CPC A61F 5/4556; A61F 5/3746; A61F 5/455;
A47K 11/12; A61M 1/00; A61B 10/007
See application file for complete search history.

(56) **References Cited**

U.S. PATENT DOCUMENTS

2,734,198 A * 2/1956 Kutsche A61F 5/4556
229/405
2,794,457 A * 6/1957 Nicodemus A47F 13/08
141/344

(Continued)

OTHER PUBLICATIONS

Stand up website, stand up product, Apr. 28, 2014, <http://www.the-stand-up.com/>.*

(Continued)

Primary Examiner — David Muller

Assistant Examiner — Nathan Johnston

(74) *Attorney, Agent, or Firm* — Frost Brown Todd LLC

(57) **CLAIM**

The ornamental design for a urinary assistance device, as shown and described.

DESCRIPTION

FIG. 1 is a front elevation view of a urinary assistance device in an unassembled, flat configuration, showing my new design;

FIG. 2 is a rear elevation view thereof;

FIG. 3 is a perspective view of the urinary assistance device of FIG. 1, in an assembled configuration, with a top flap thereof in an open position;

FIG. 4 is a front elevation view thereof;

FIG. 5 is a rear elevation view thereof;

FIG. 6 is a left side elevation view thereof;

FIG. 7 is a right side elevation view thereof;

FIG. 8 is a top plan view thereof;

FIG. 9 is a bottom plan view thereof;

FIG. 10 is a perspective view of the urinary assistance device of FIG. 1, in an assembled configuration, with the top flap thereof in a closed position;

FIG. 11 is a front elevation view thereof;

FIG. 12 is a rear elevation view thereof;

FIG. 13 is a left side elevation view thereof;

FIG. 14 is a right side elevation view thereof;

FIG. 15 is a top plan view thereof;

FIG. 16 is a bottom plan view thereof;

FIG. 17 is a perspective view of the urinary assistance device of FIG. 1, in an assembled, expanded configuration;

FIG. 18 is a front elevation view thereof;

FIG. 19 is a rear elevation view thereof;

FIG. 20 is a left side elevation view thereof;

FIG. 21 is a right elevation view thereof;

FIG. 22 is a top plan view thereof; and,

FIG. 23 is a bottom plan view thereof.

The features shown in broken lines depict environmental subject matter only and form no part of the claimed design.

1 Claim, 7 Drawing Sheets

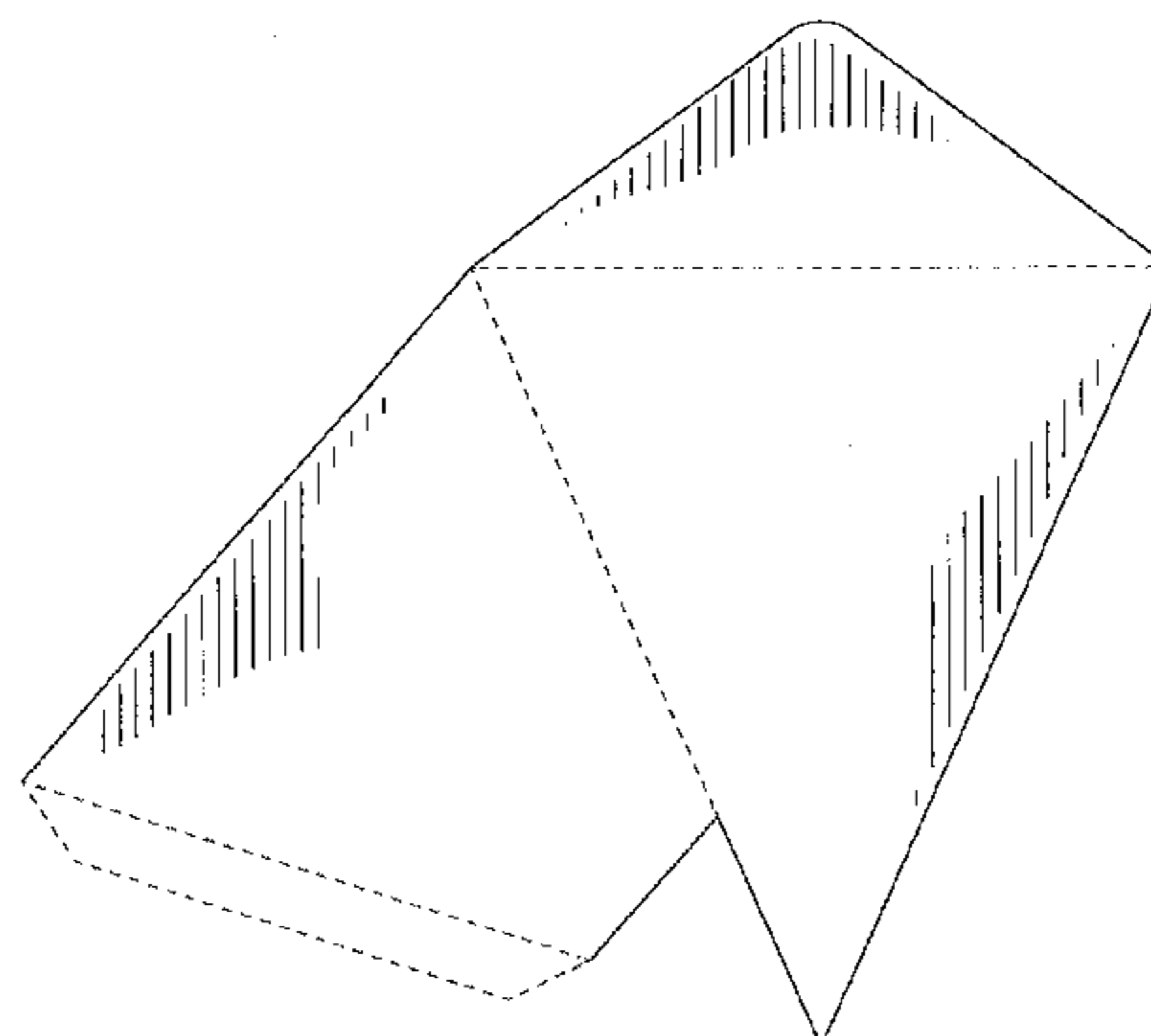

(56)

References Cited

U.S. PATENT DOCUMENTS

2,878,486 A * 3/1959 Bartlett A61F 5/4556
4/144.4
D195,617 S * 7/1963 Eger D11/143
4,681,573 A * 7/1987 McGovern A61F 5/4556
4/144.3
5,408,703 A * 4/1995 Cicio A47K 11/12
4/144.2
D379,225 S * 5/1997 Canahuate 4/144.4
D383,949 S * 9/1997 Lown D7/700
5,806,107 A * 9/1998 Tilton E03D 13/00
4/301
D420,869 S * 2/2000 Diehl D23/200
D422,674 S * 4/2000 Chrisco D23/200
6,098,210 A * 8/2000 Broden A47K 11/12
4/144.1
D449,105 S * 10/2001 Azo D24/122
D495,798 S * 9/2004 Gugliotta D24/122
D499,482 S * 12/2004 Gugliotta D24/122
D527,101 S * 8/2006 Fernandez D24/122
D602,156 S * 10/2009 Young D24/122
7,682,347 B2 * 3/2010 Parks A61F 5/4556
206/210
D649,239 S * 11/2011 Taravella D24/122
D728,328 S * 5/2015 Wirth D7/700
D731,052 S * 6/2015 Doerr D24/121
D735,849 S * 8/2015 Rudolph D24/122
D745,328 S * 12/2015 Magri D1/105

2003/0056283 A1* 3/2003 Wang A61F 5/4556
4/144.4
2009/0089919 A1* 4/2009 Rudolph A61F 5/4556
4/144.4
2013/0239311 A1* 9/2013 Valenti A61F 5/3746
4/144.3

OTHER PUBLICATIONS

GoGirl, FemMed, Inc., downloaded from <http://www.go-girl.com>, Dec. 2014.
Magic Cone, Rightech-Co., downloaded from <http://www.magic-cone.com/>, 2010.
P EZ Female Urination Device with Case—Stand Up & Pee, First Response, downloaded from <http://www.sportinggoodsoutdoor.com/p/detail/B004APOFTI/P-EZ-Female-Urination-Device-with-Case-Stand-Up-Pee.html>, 2010.
P-Mate, P-Mate USA, downloaded from <http://www.pmateusa.com/>, 2013.
The Original Shewee, Shewee, downloaded from <http://www.shewee.com/>, 2014.
Uri-femme, female urination funnel, Uri-Tech Corporation, downloaded from <http://urifemme.com/>, 2015.
Urinelle, Huikeshoven Medical BV, downloaded from <http://web.archive.org/web/20150221122203/http://www.biorelief.com/portable-toilets/tailgating-supplies/7-pack-urinelle-female-urinary-device-paper-cone.html>, Feb. 21, 2015.

* cited by examiner

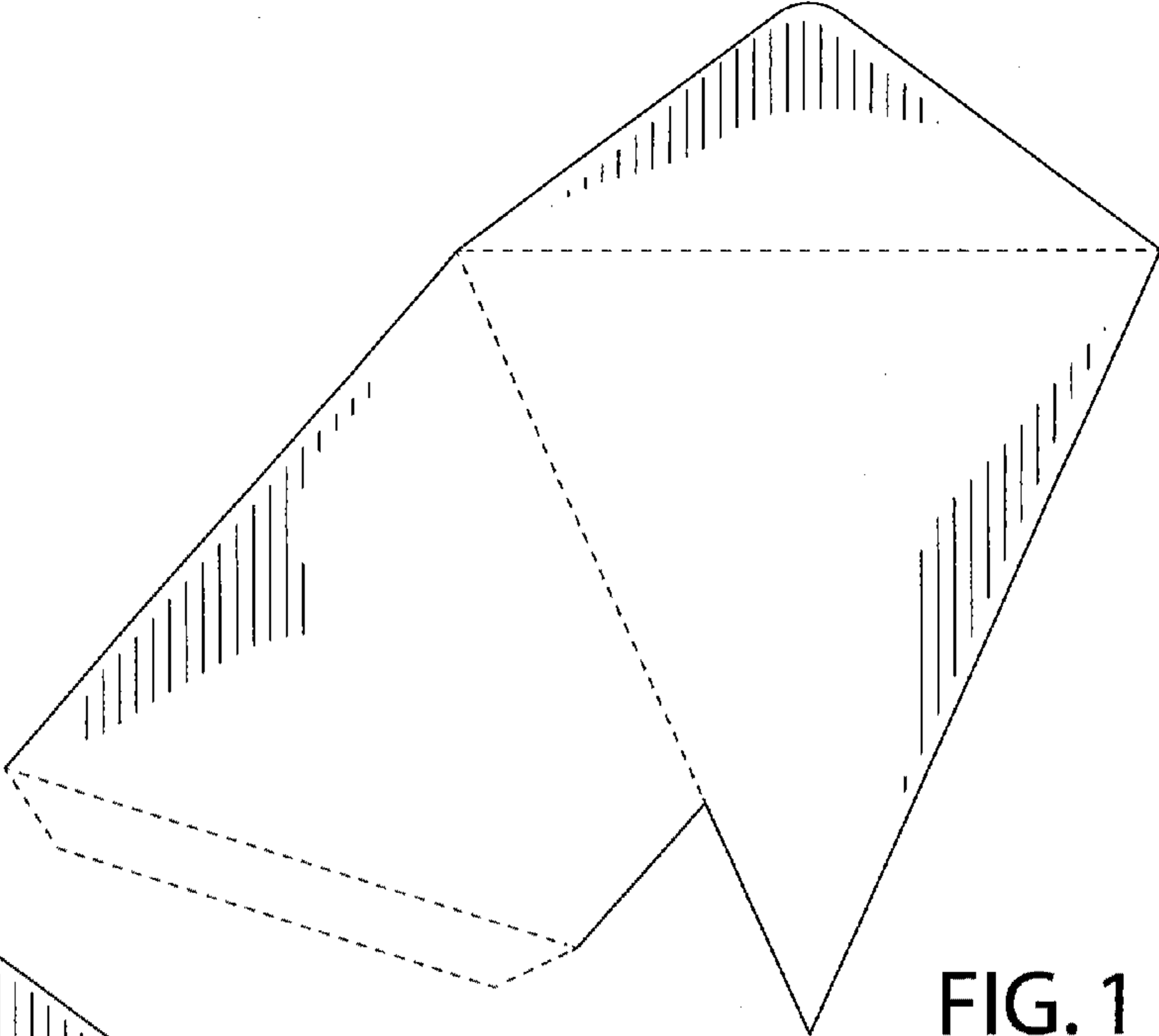

FIG. 1

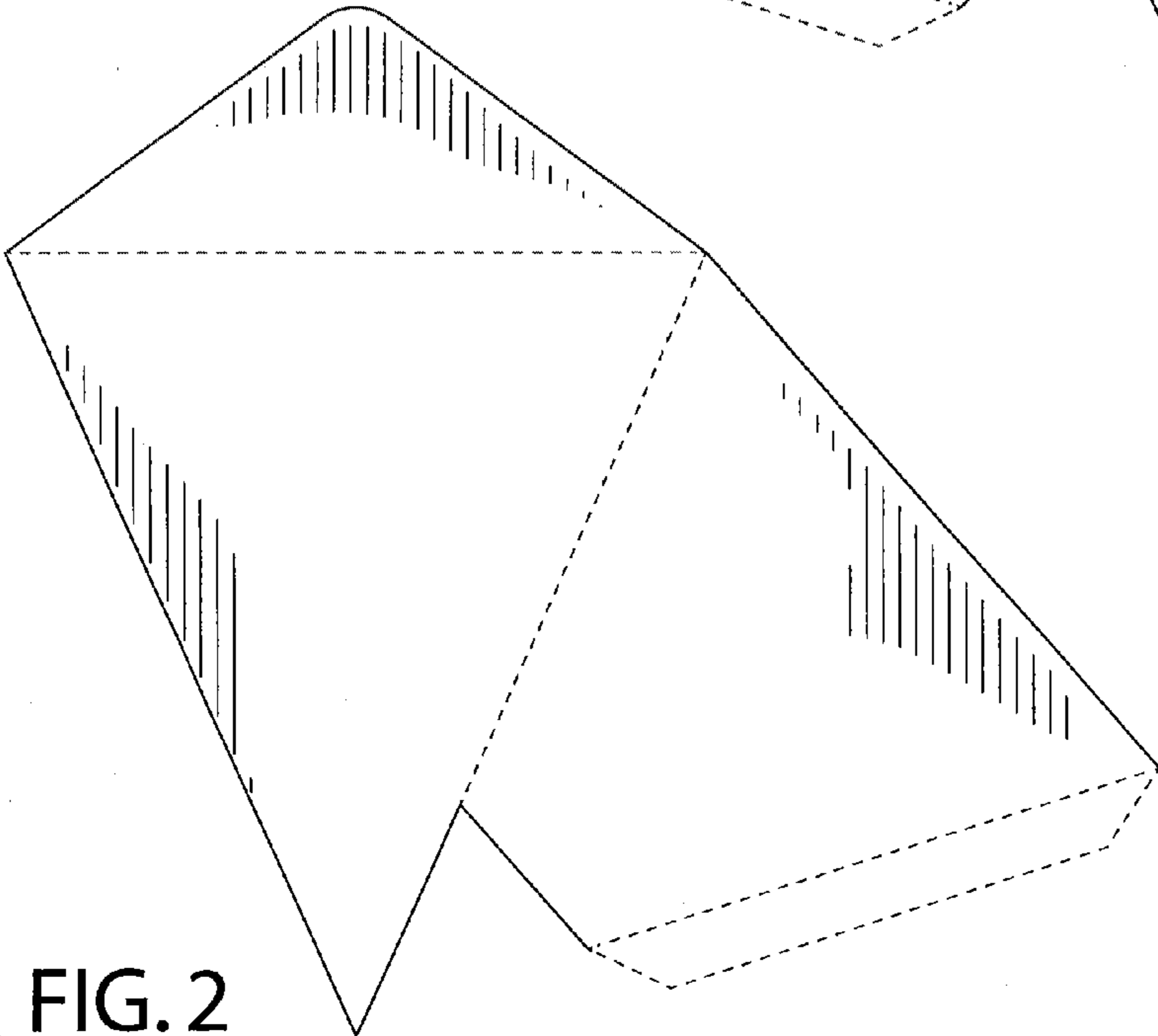

FIG. 2

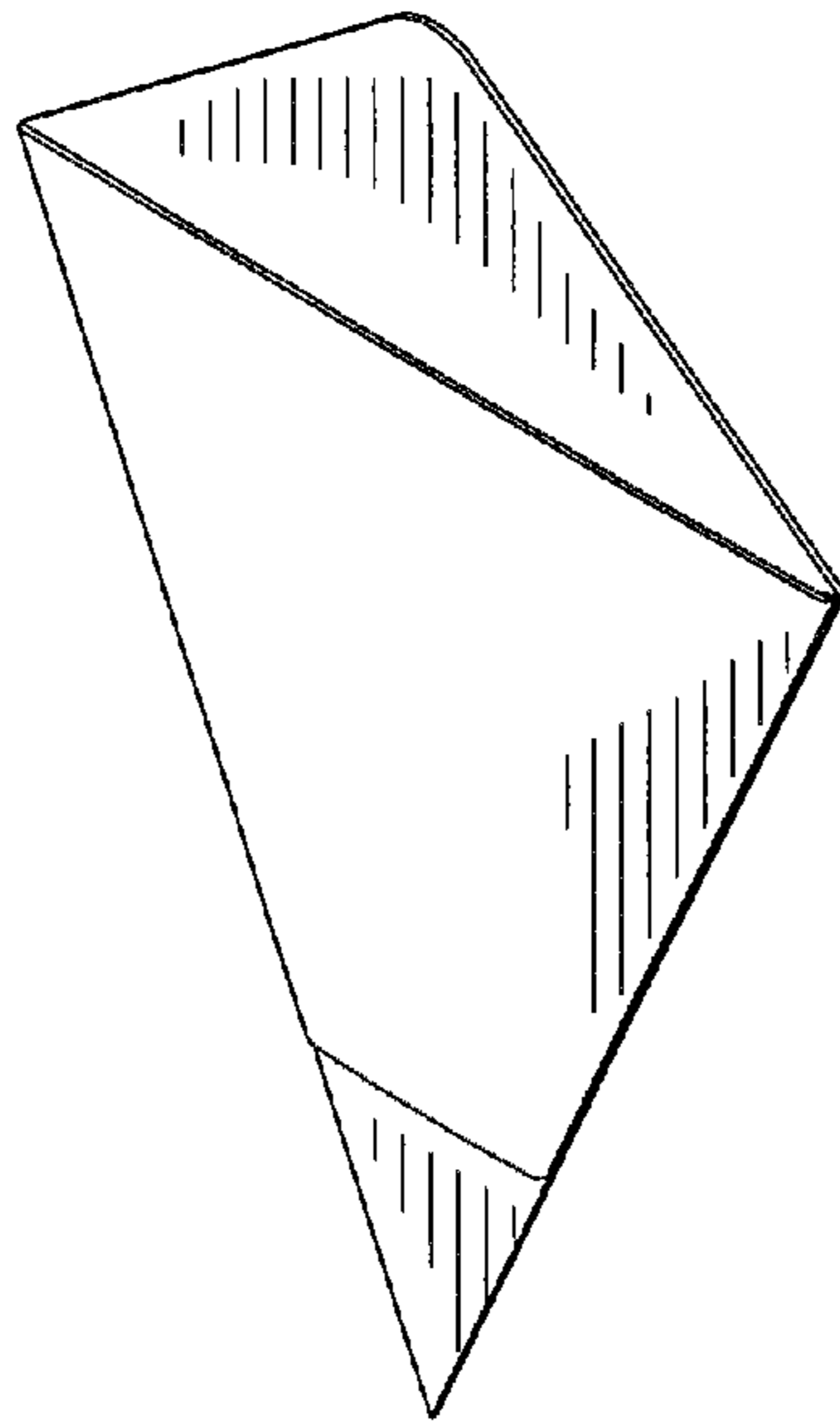

FIG. 3

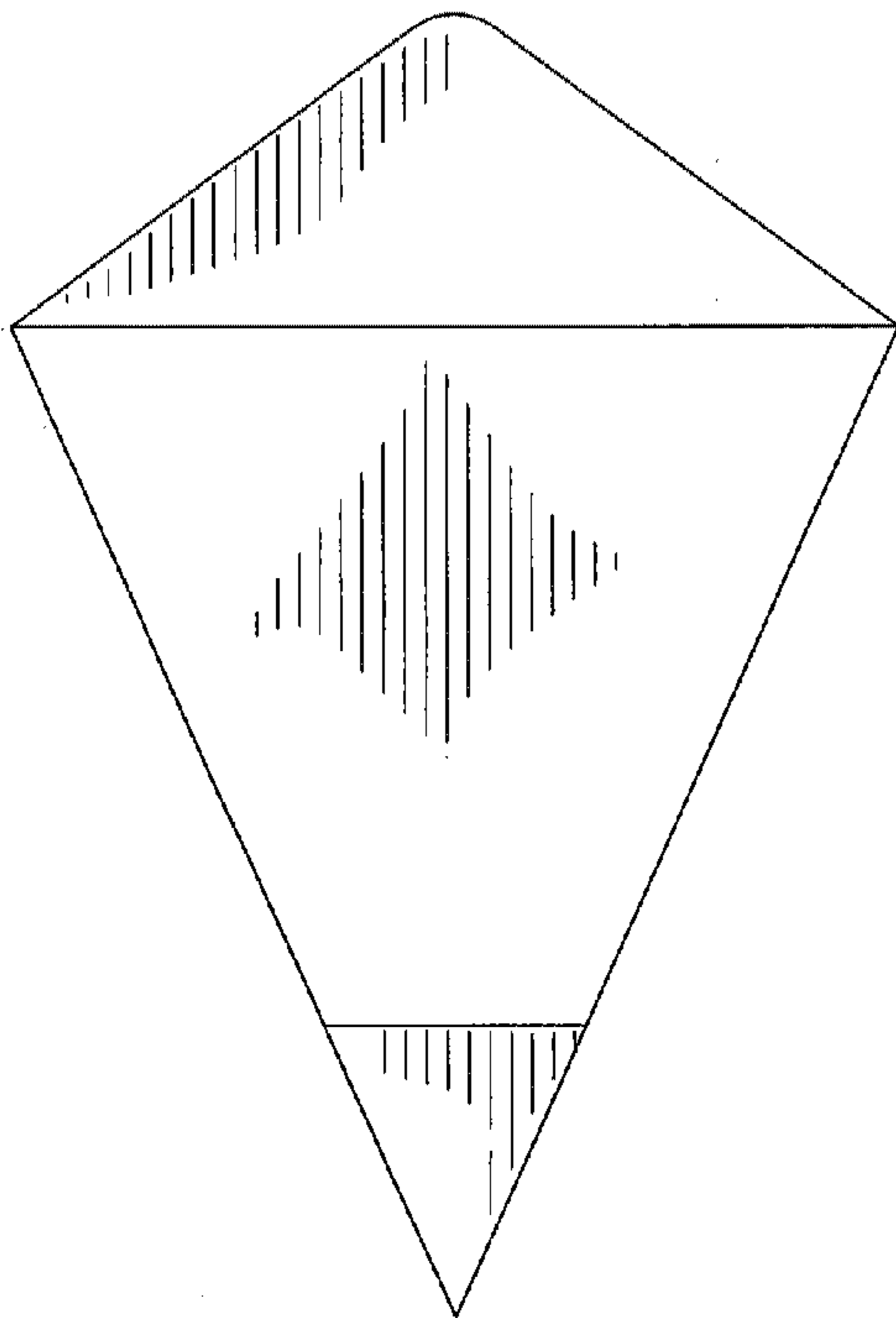

FIG. 4

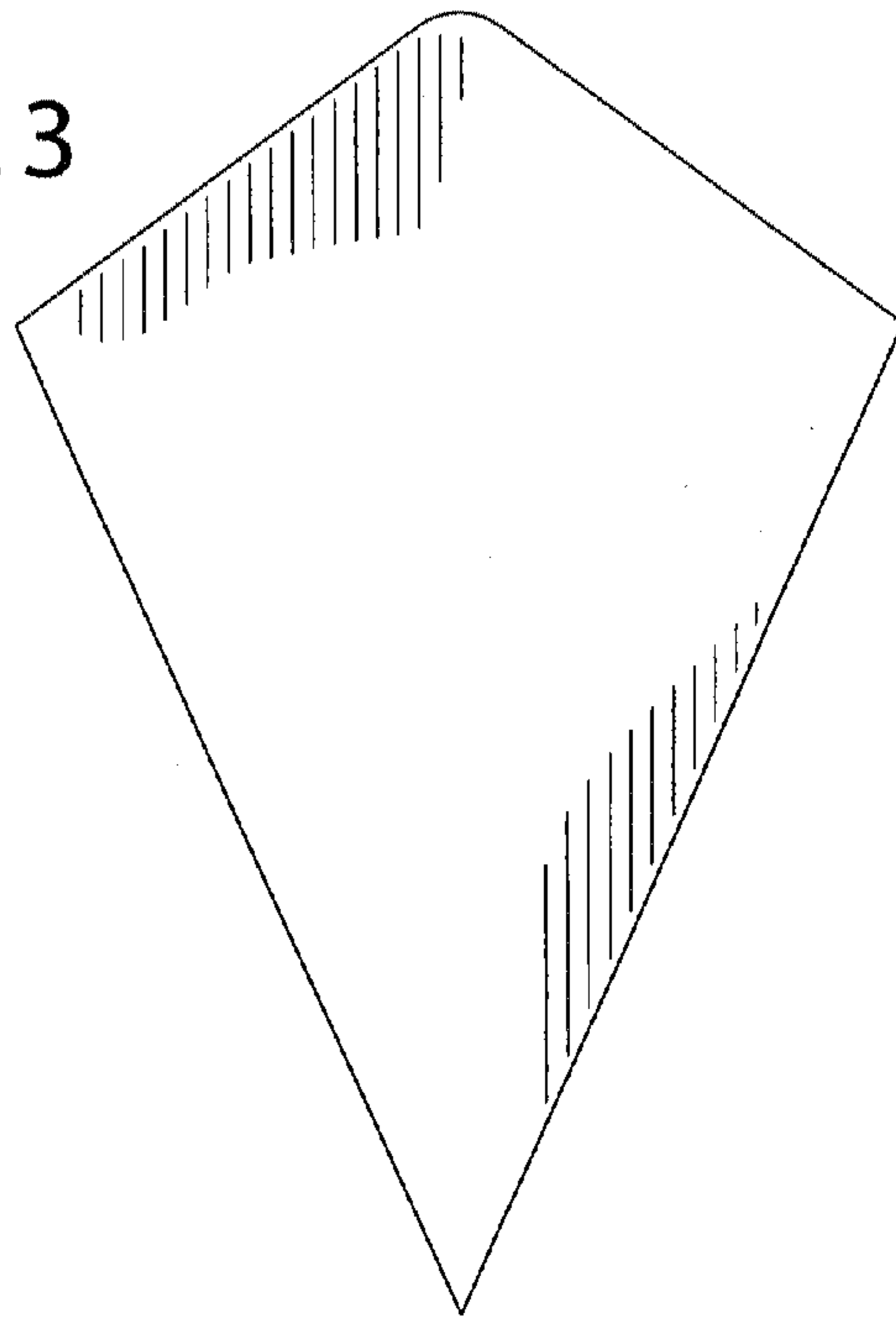

FIG. 5



FIG. 6



FIG. 7

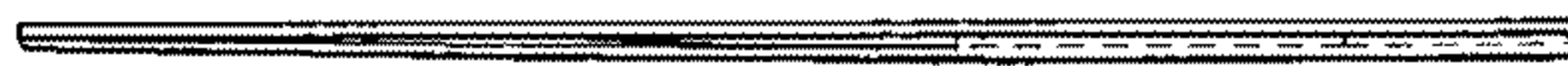

FIG. 8

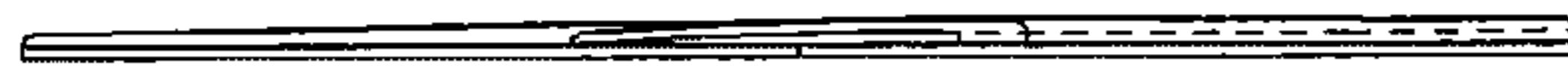

FIG. 9

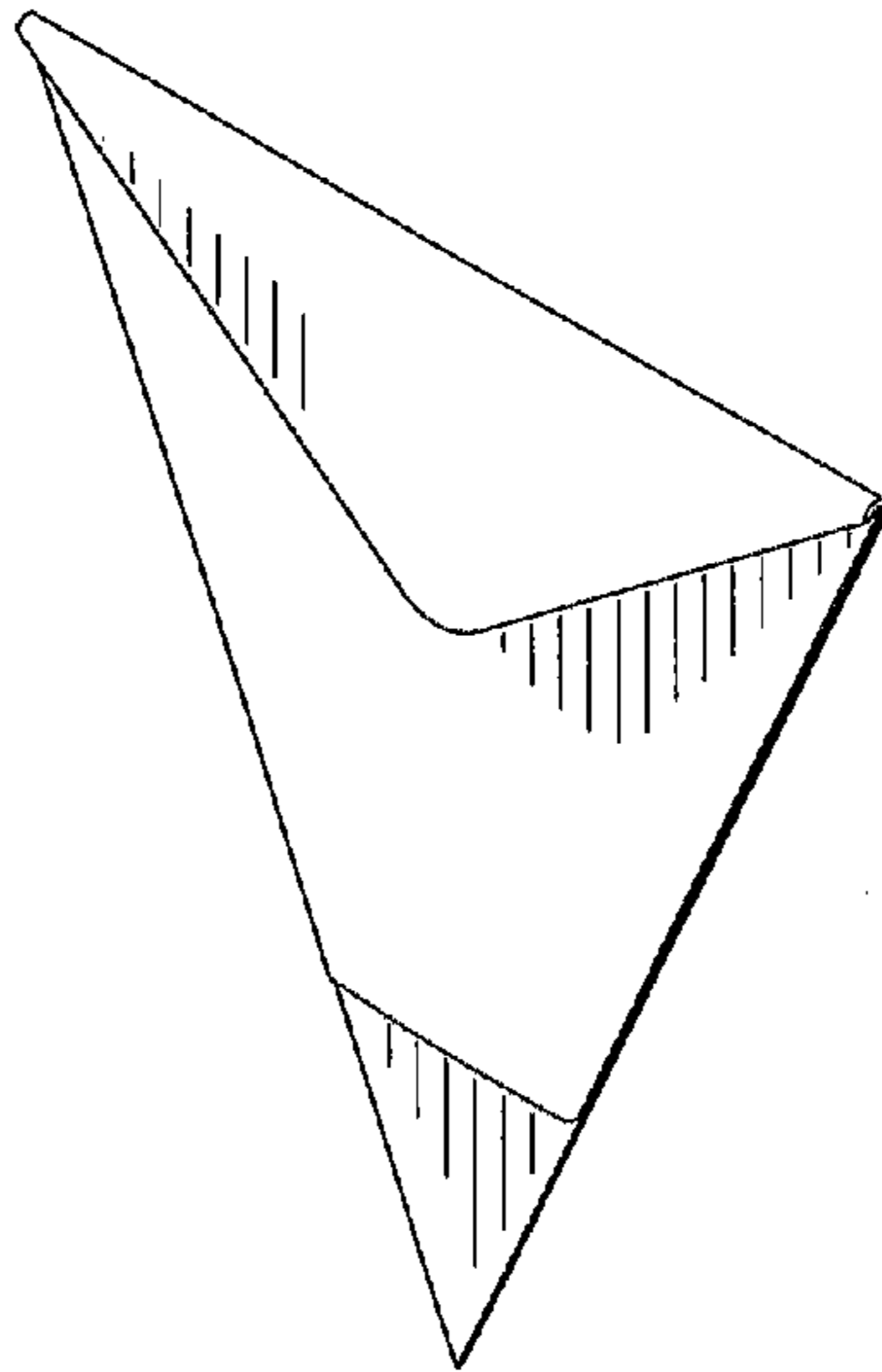

FIG. 10

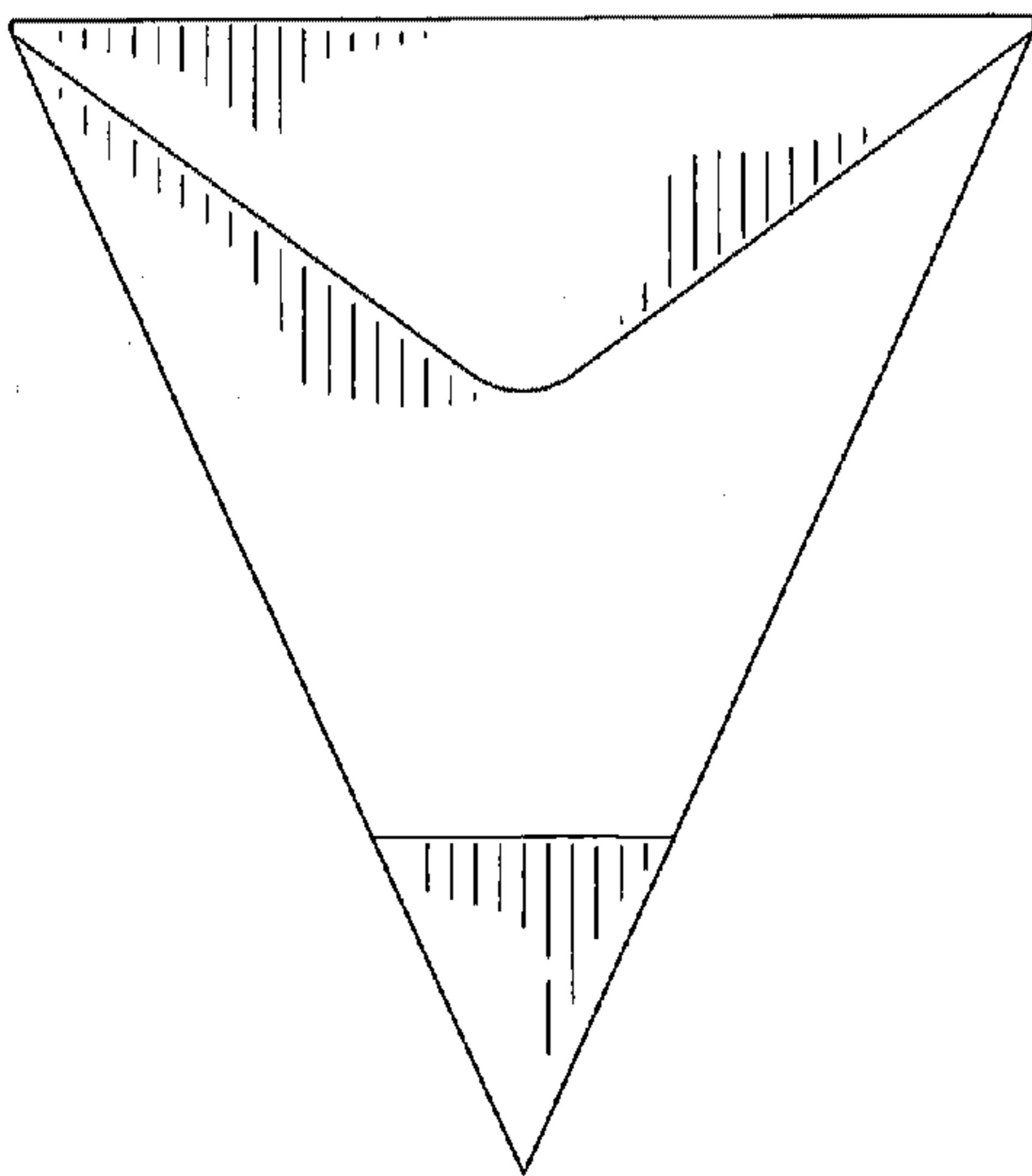

FIG. 11

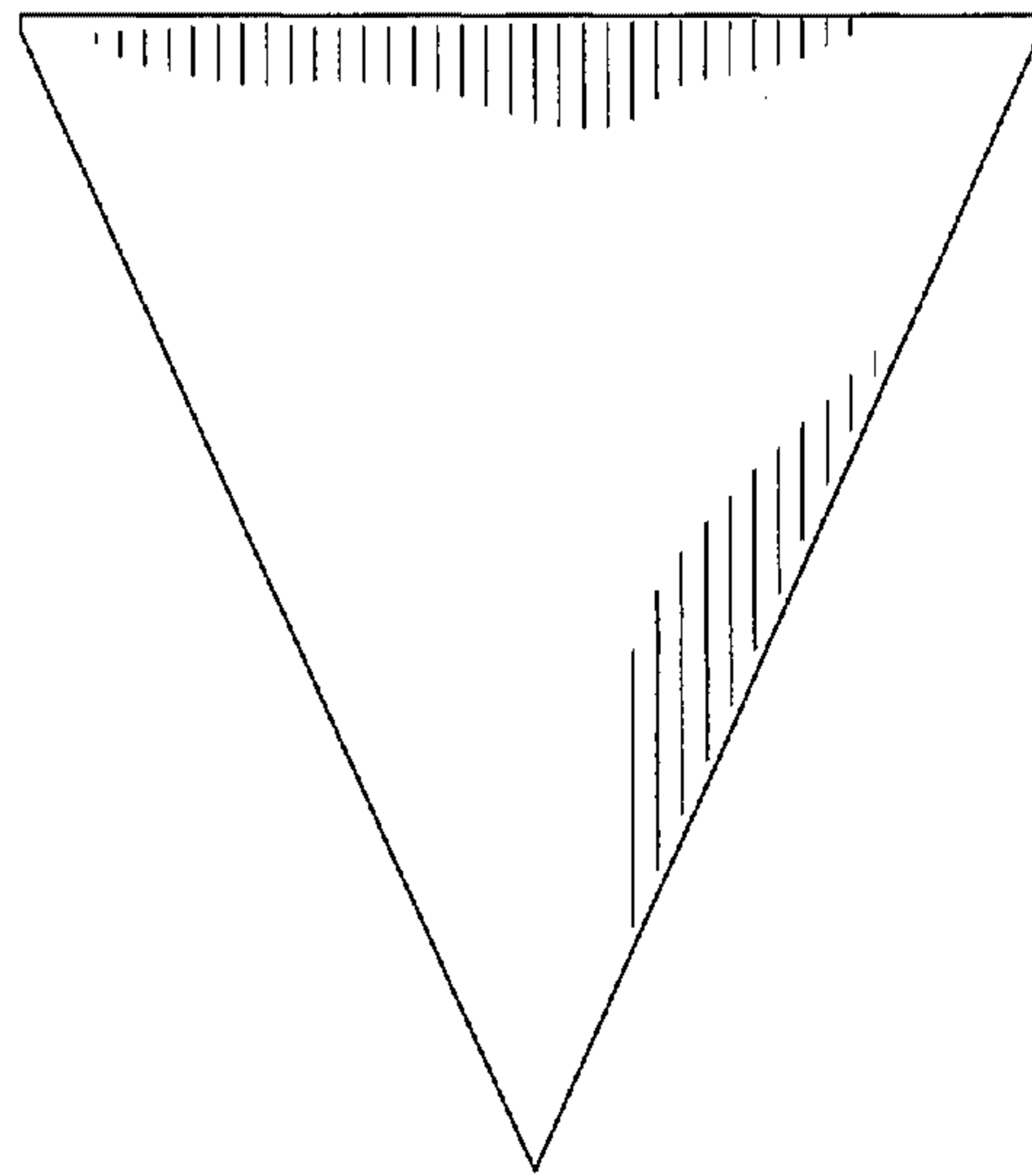

FIG. 12



FIG. 13



FIG. 14

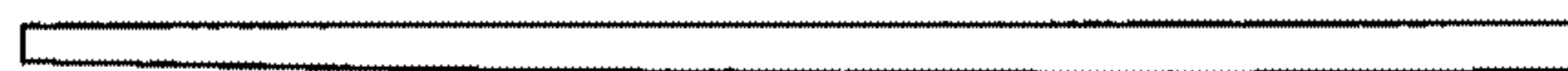

FIG. 15



FIG. 16

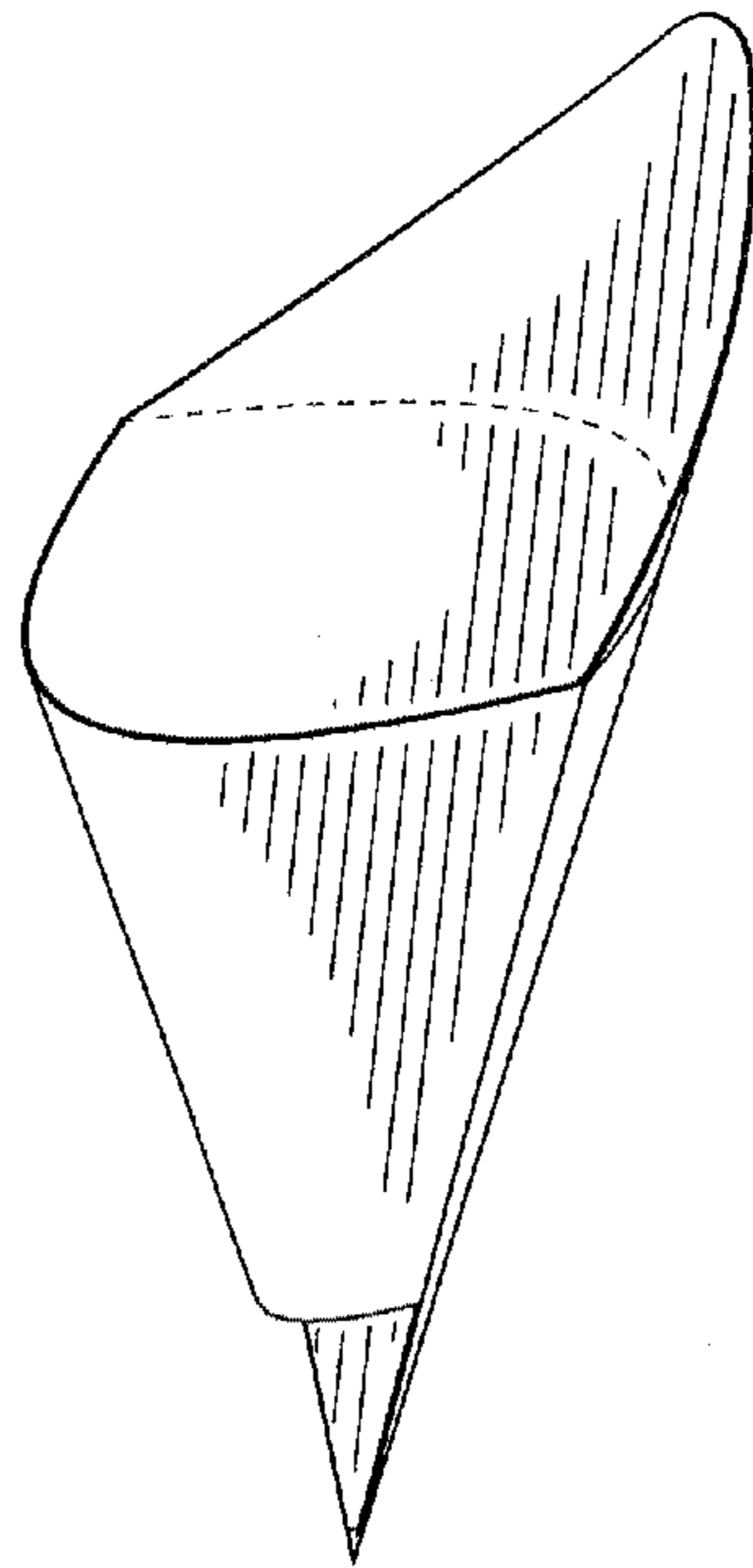

FIG. 17

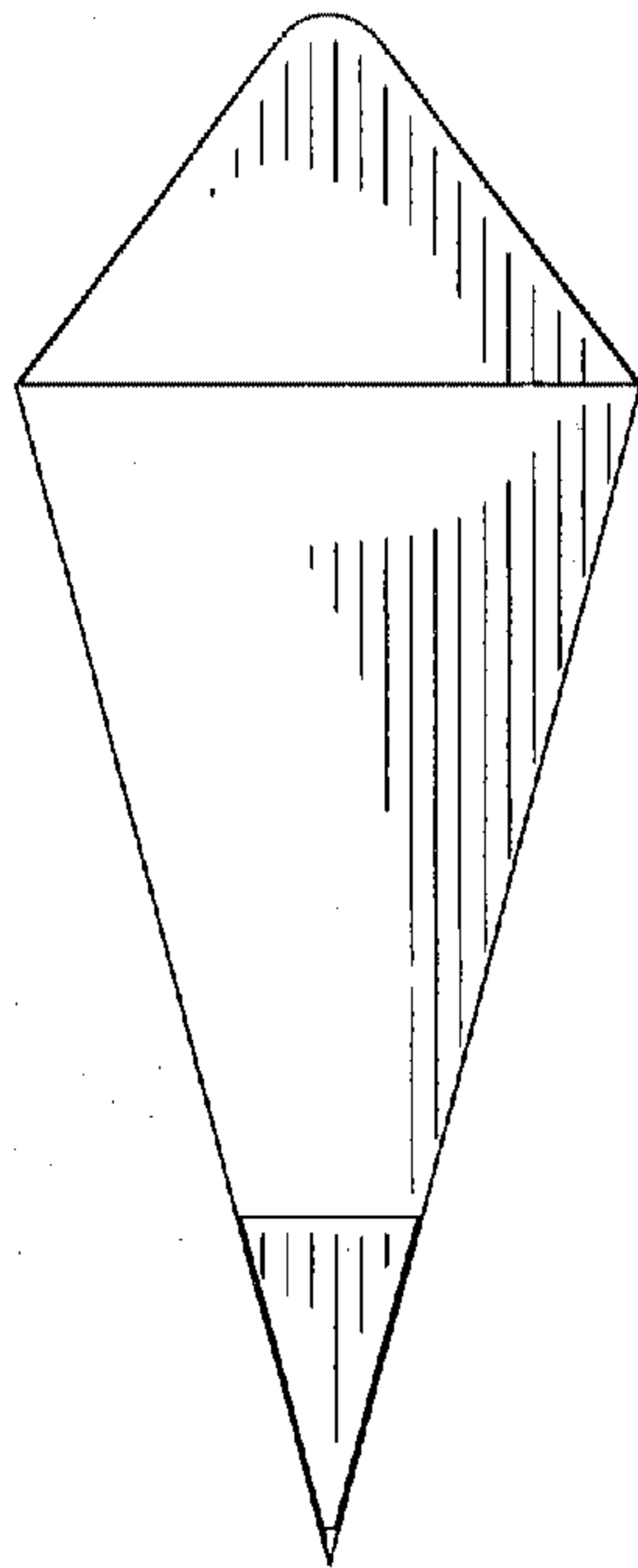

FIG. 18

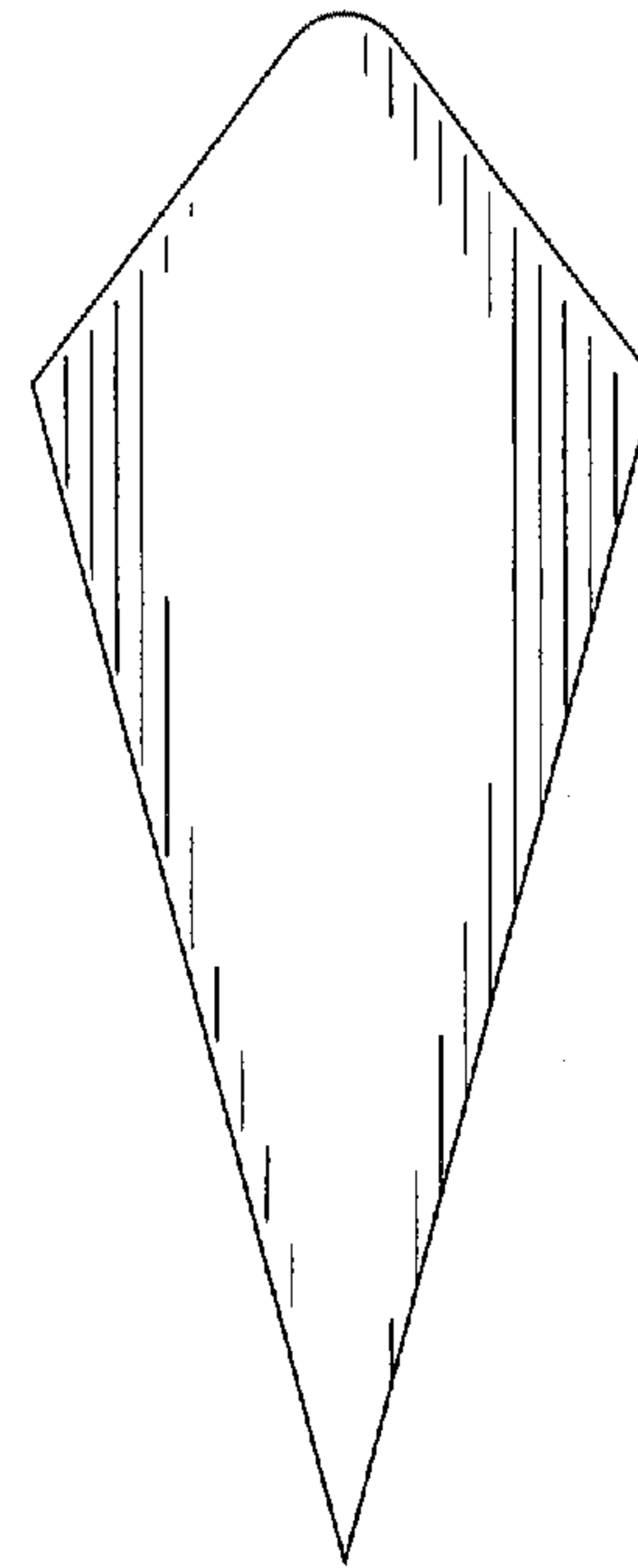

FIG. 19

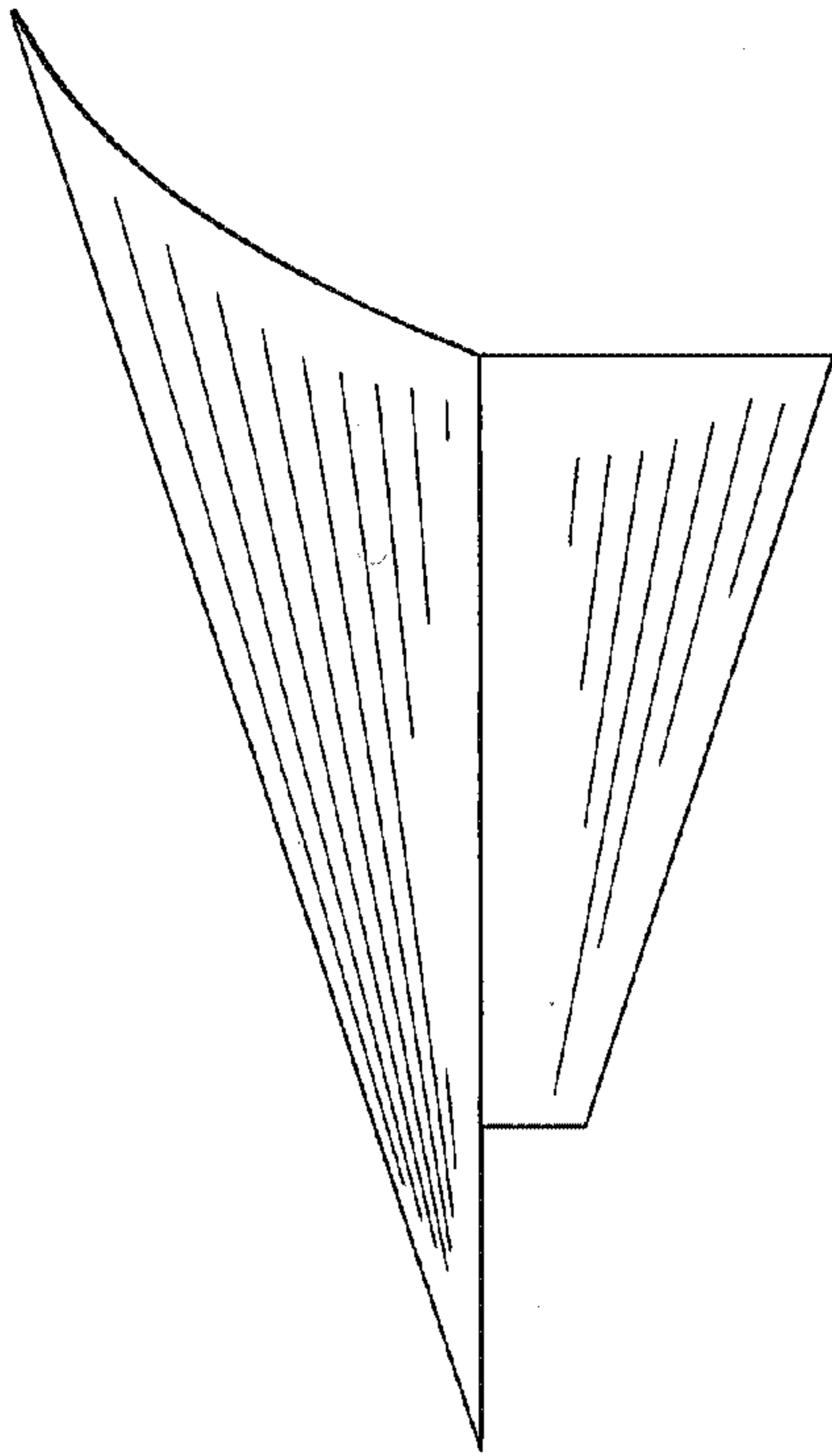

FIG. 20

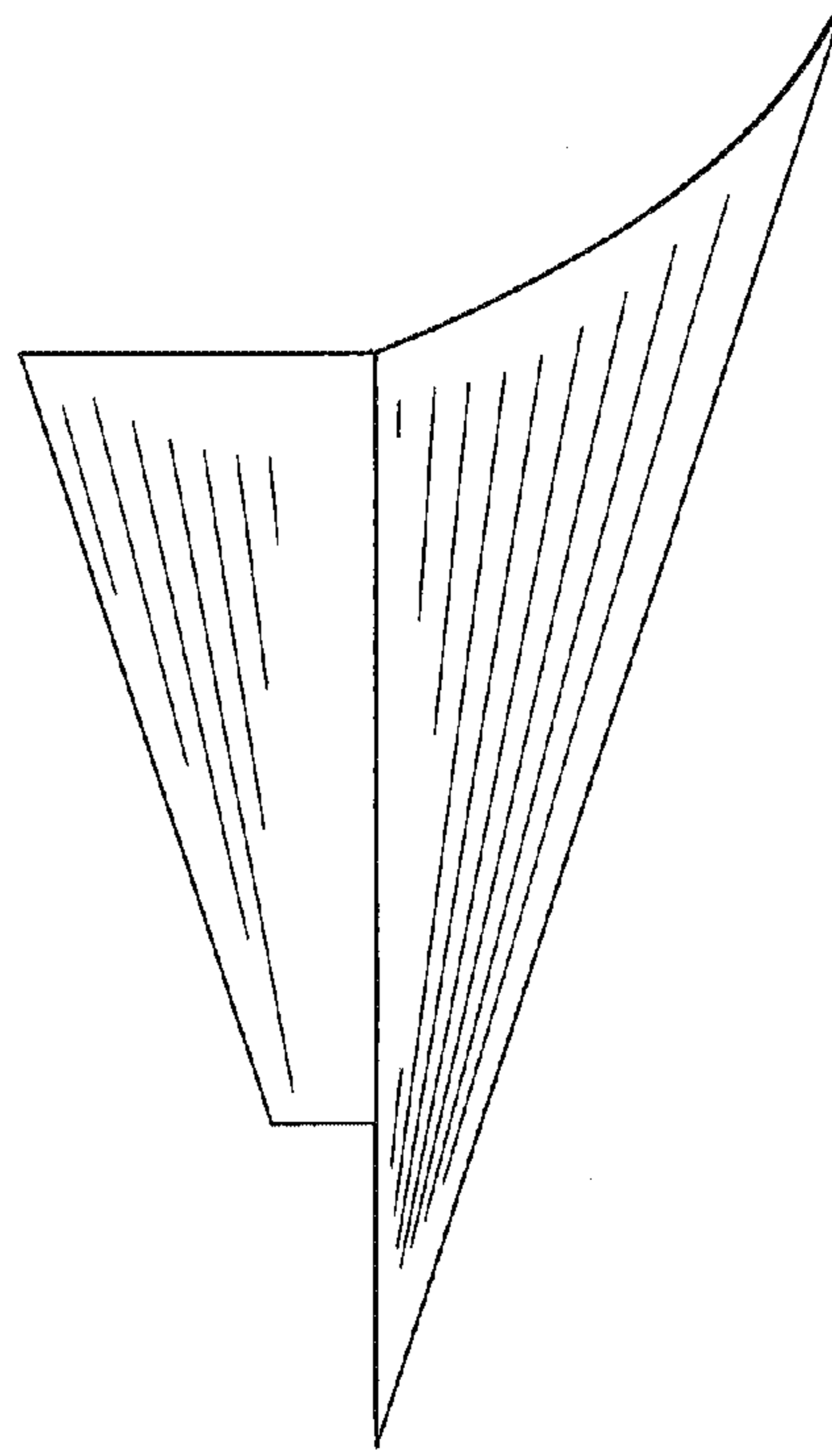

FIG. 21

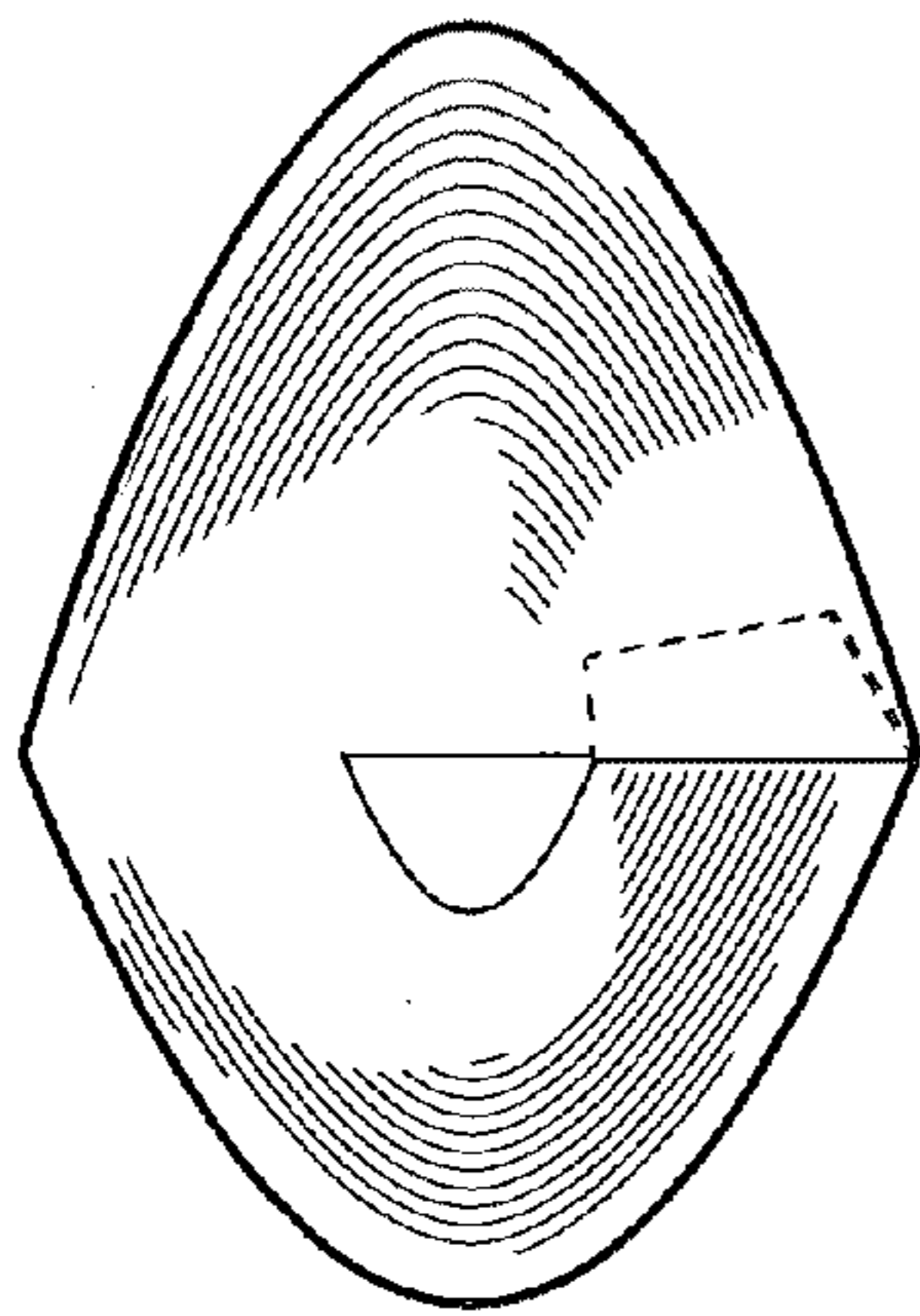

FIG. 22

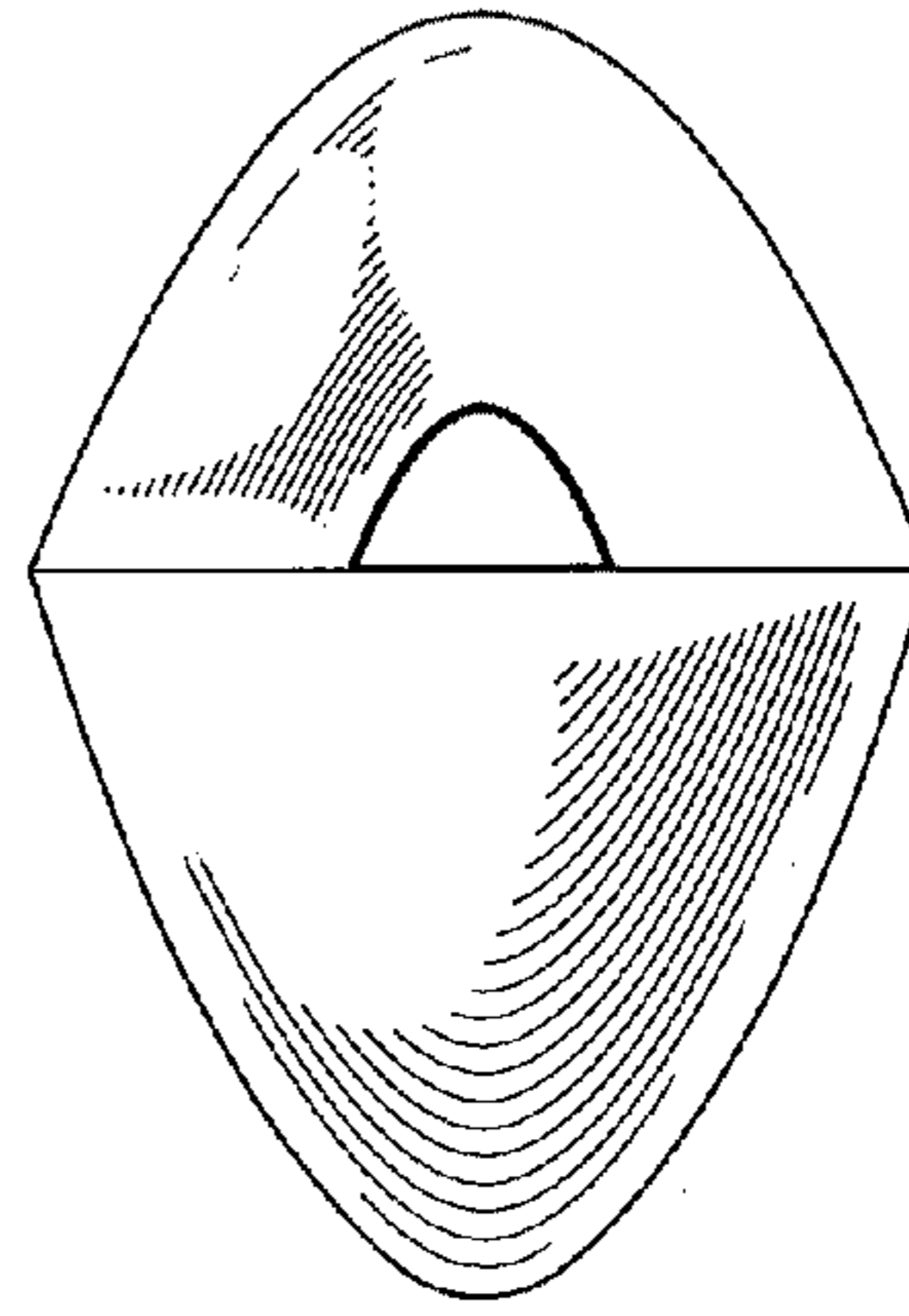

FIG. 23