



US00D757191S

(12) **United States Design Patent**  
**Palmer**

(10) **Patent No.:** **US D757,191 S**  
(45) **Date of Patent:** **\*\* May 24, 2016**

(54) **KICKOFF TEE**  
(71) Applicant: **Garrett Craig Palmer**, McKinney, TX (US)  
(72) Inventor: **Garrett Craig Palmer**, McKinney, TX (US)  
(\*\*) Term: **14 Years**  
(21) Appl. No.: **29/520,594**  
(22) Filed: **Mar. 16, 2015**  
(51) **LOC (10) Cl.** ..... **21-02**  
(52) **U.S. Cl.**  
USPC ..... **D21/716**  
(58) **Field of Classification Search**  
USPC ..... D9/715–718  
CPC .. A63B 69/00; A63B 69/002; A63B 69/0073; A63B 69/0075; A63B 2243/0025; A63B 2243/0066; A63B 2243/007; A63B 57/10; A63B 57/13; A63B 57/16; A63B 57/20  
See application file for complete search history.

6,413,175 B1 \* 7/2002 Mooney, Jr. .... A63B 69/0075 473/417  
D491,619 S 6/2004 Crouse  
D507,814 S \* 7/2005 Spiegel ..... D21/716  
7,828,677 B2 \* 11/2010 Steinhobel ..... A63B 57/10 473/387  
D634,798 S \* 3/2011 Suisham ..... D21/717  
D656,568 S 3/2012 Palmer  
8,992,348 B2 \* 3/2015 Meier ..... A63B 69/0002 473/417  
9,011,276 B2 \* 4/2015 Holland ..... A63B 69/0075 473/420  
D729,327 S \* 5/2015 Christoffel ..... D21/716  
2004/0097304 A1 5/2004 Sharp  
2005/0070378 A1 3/2005 Parks et al.  
2006/0205537 A1 \* 9/2006 Kiah ..... A63B 57/10 473/387

\* cited by examiner

*Primary Examiner* — Catherine Tuttle

(74) *Attorney, Agent, or Firm* — Quickpatents, LLC; Kevin Prince

(57) **CLAIM**

I claim the ornamental design for a kickoff tee, as shown and described.

**DESCRIPTION**

FIG. 1 is a top perspective view of a kickoff tee, showing my new design;  
FIG. 2 is a perspective view similar to FIG. 1, but showing one removable tuft in an exploded state;  
FIG. 3 is a bottom perspective view thereof, showing the tuft element in an alternate, stored position;  
FIG. 4 is a left-side elevational view of FIG. 1;  
FIG. 5 is a right-side elevational view of FIG. 1;  
FIG. 6 is a front elevational view of FIG. 1;  
FIG. 7 is a rear elevational view of FIG. 1;  
FIG. 8 is an exploded top plan view of FIG. 2; and,  
FIG. 9 is an exploded bottom plan view of FIG. 2.  
The broken lines showing a football and additional tuft elements in FIG. 1 depict environmental matter and form no part of the claimed design. The portions of the kickoff tee between the parallel, horizontal broken lines form no part of the claim design.

**1 Claim, 3 Drawing Sheets**

(56) **References Cited**  
U.S. PATENT DOCUMENTS

1,570,926 A	1/1926	Sibbald	
D150,195 S	6/1947	Barton	
D164,166 S *	8/1951	Griswold	273/127 B
2,659,604 A *	11/1953	McGowen	A63B 69/0075 473/420
D176,029 S *	11/1955	Martin	D21/716
D195,088 S	4/1963	Box	
D202,433 S	9/1965	Cullity	
D230,492 S	2/1974	Romer, Jr. et al.	
D231,002 S	3/1974	Ponder	
4,019,735 A	4/1977	Thompson	
D261,789 S *	11/1981	Allen	D21/716
D291,714 S	9/1987	Spiegel	
5,100,135 A	3/1992	Bourgeois	
D372,062 S	7/1996	Spiegel	
5,613,678 A *	3/1997	McKee	A63B 69/0075 473/397
D383,816 S	9/1997	Spiegel	
D392,705 S	3/1998	Spiegel	
6,053,822 A	4/2000	Kolodney et al.	
6,309,316 B1	10/2001	Spiegel	
D451,566 S	12/2001	De Chenne	

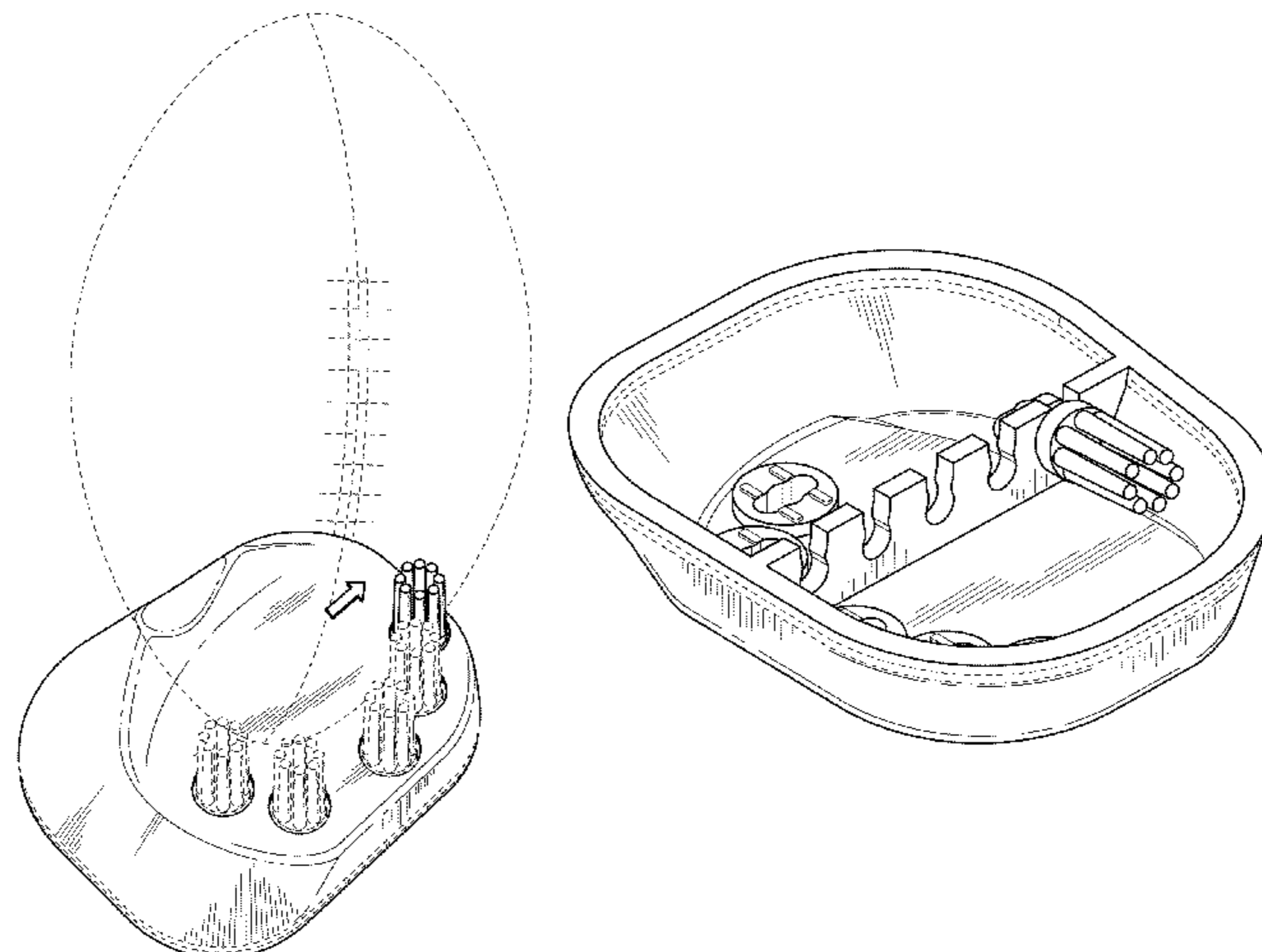

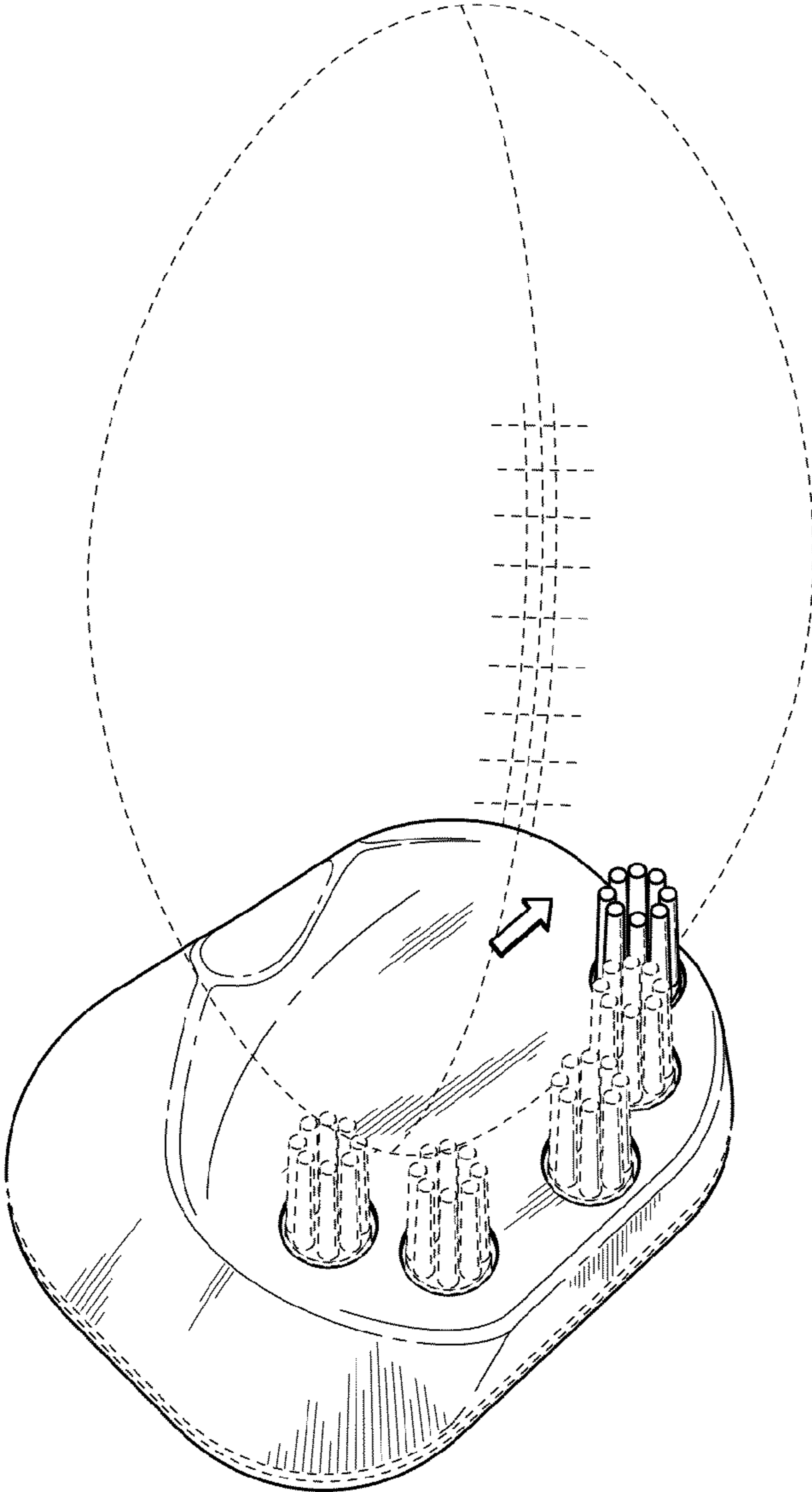

FIG. 1

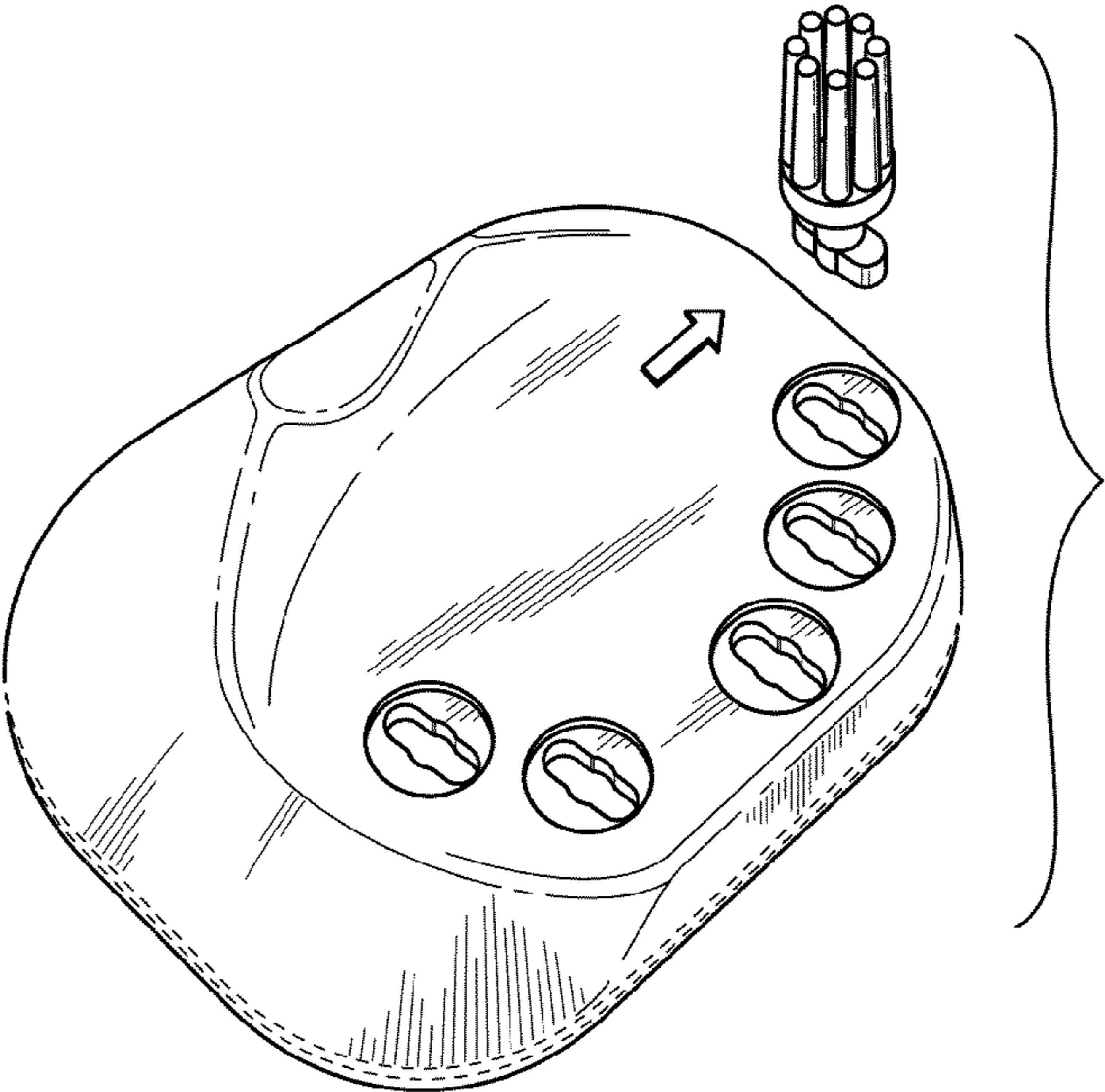

FIG. 2

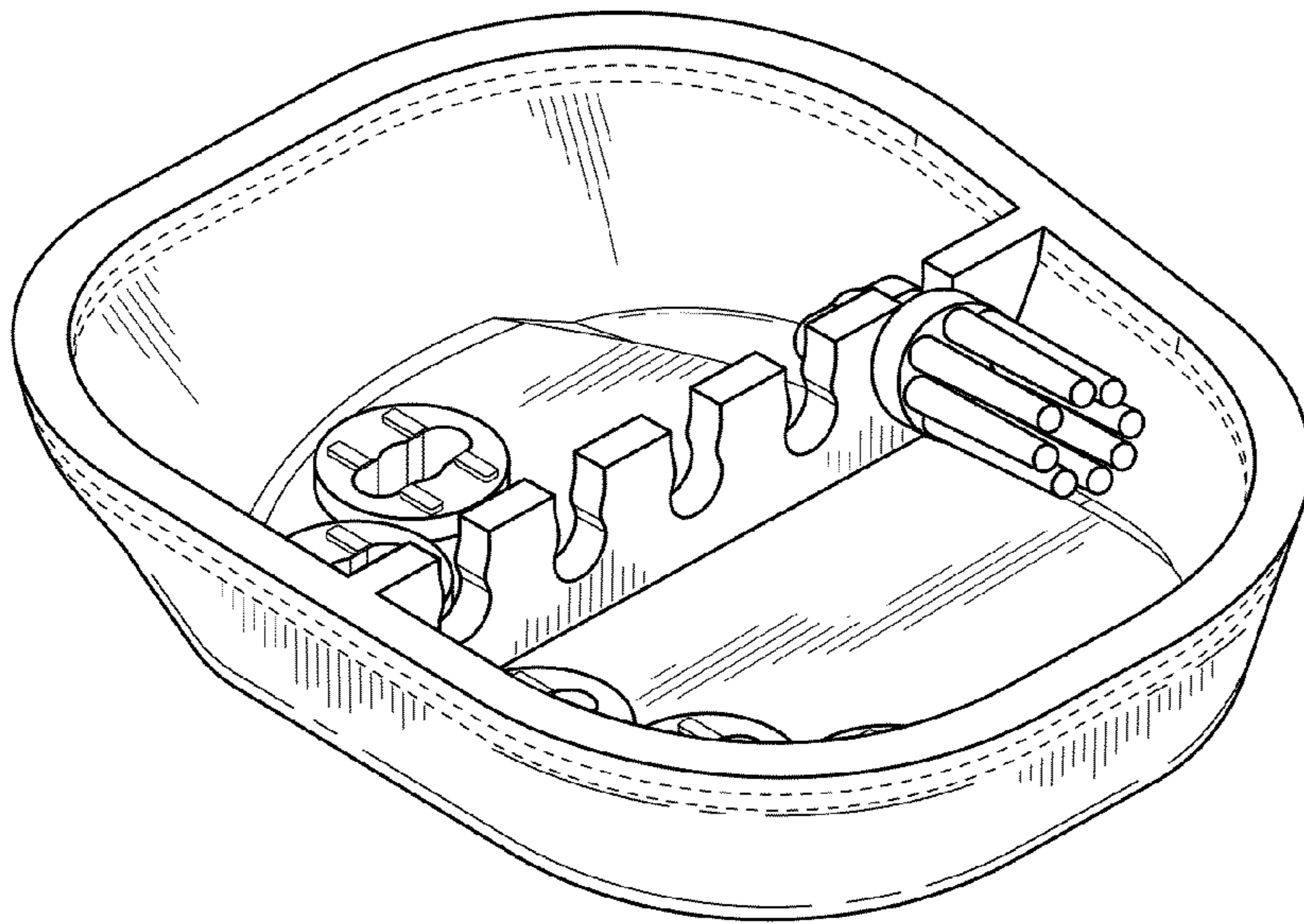

FIG. 3

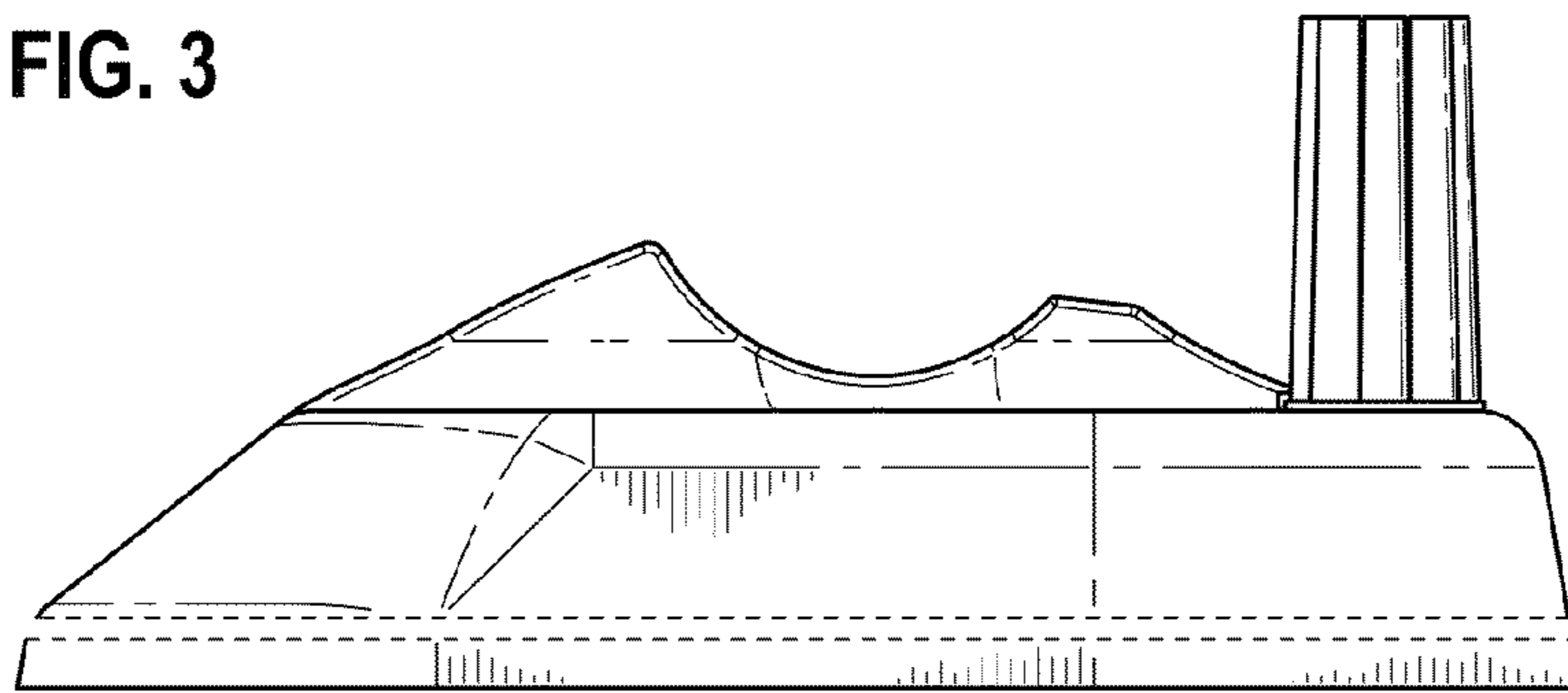

FIG. 4

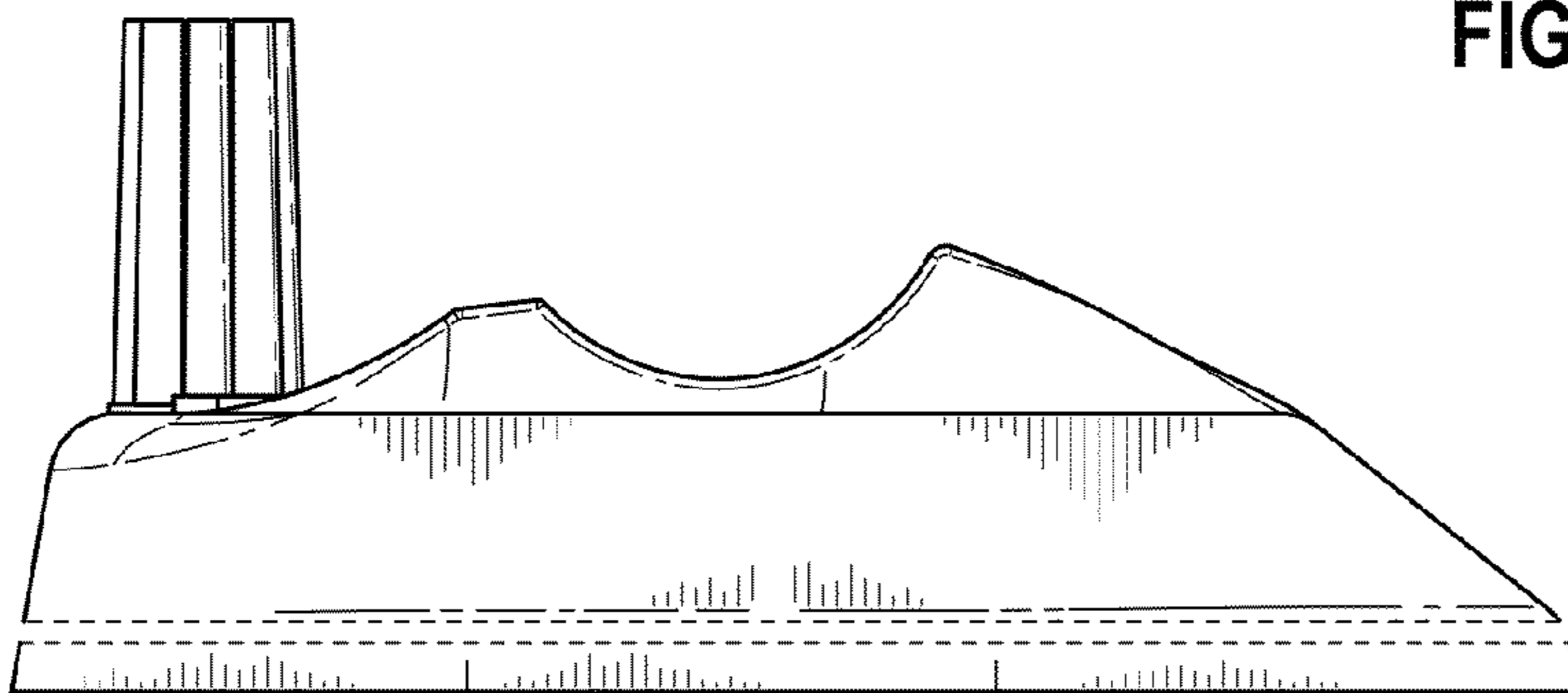

FIG. 5

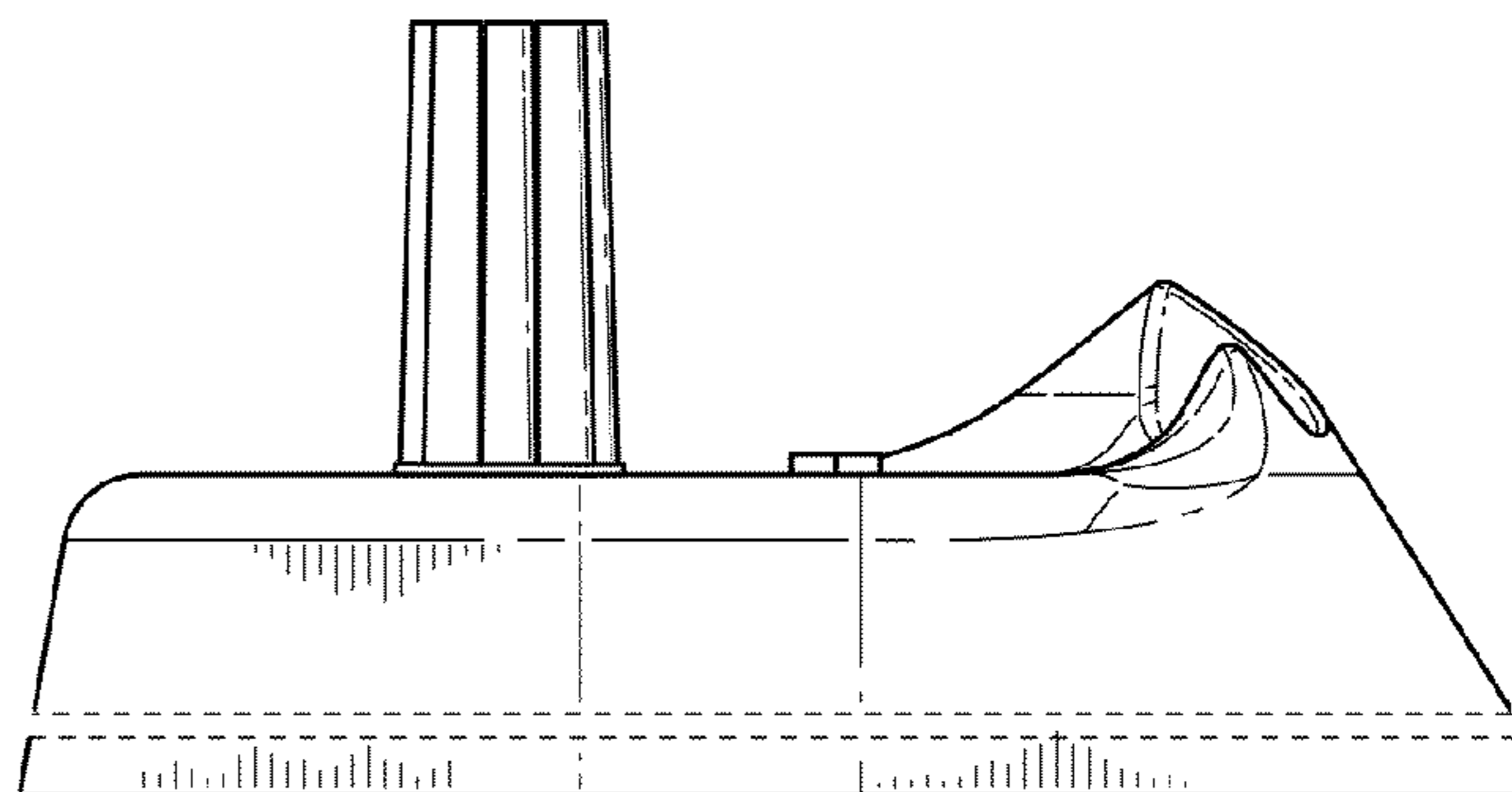

FIG. 6

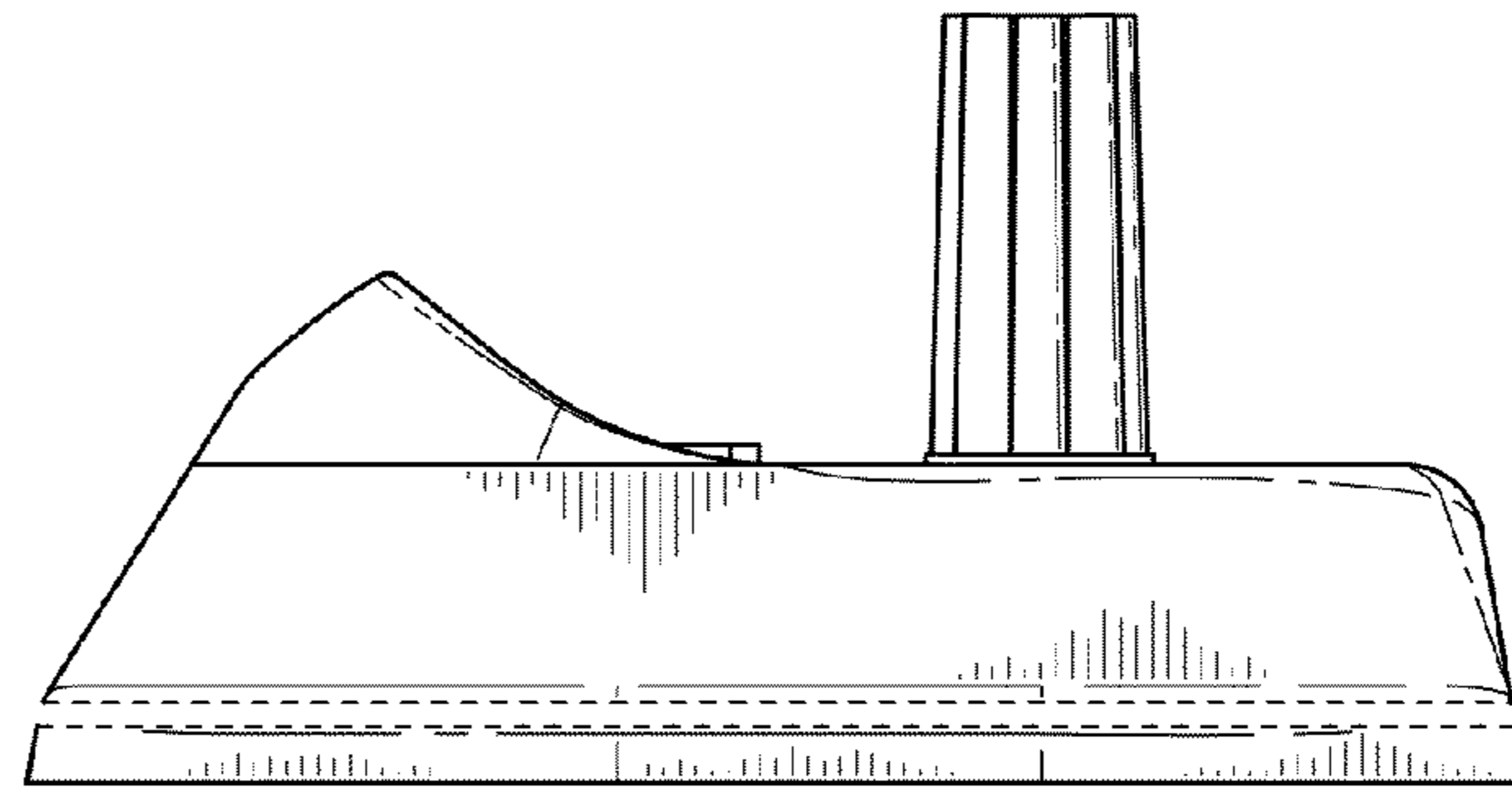

FIG. 7

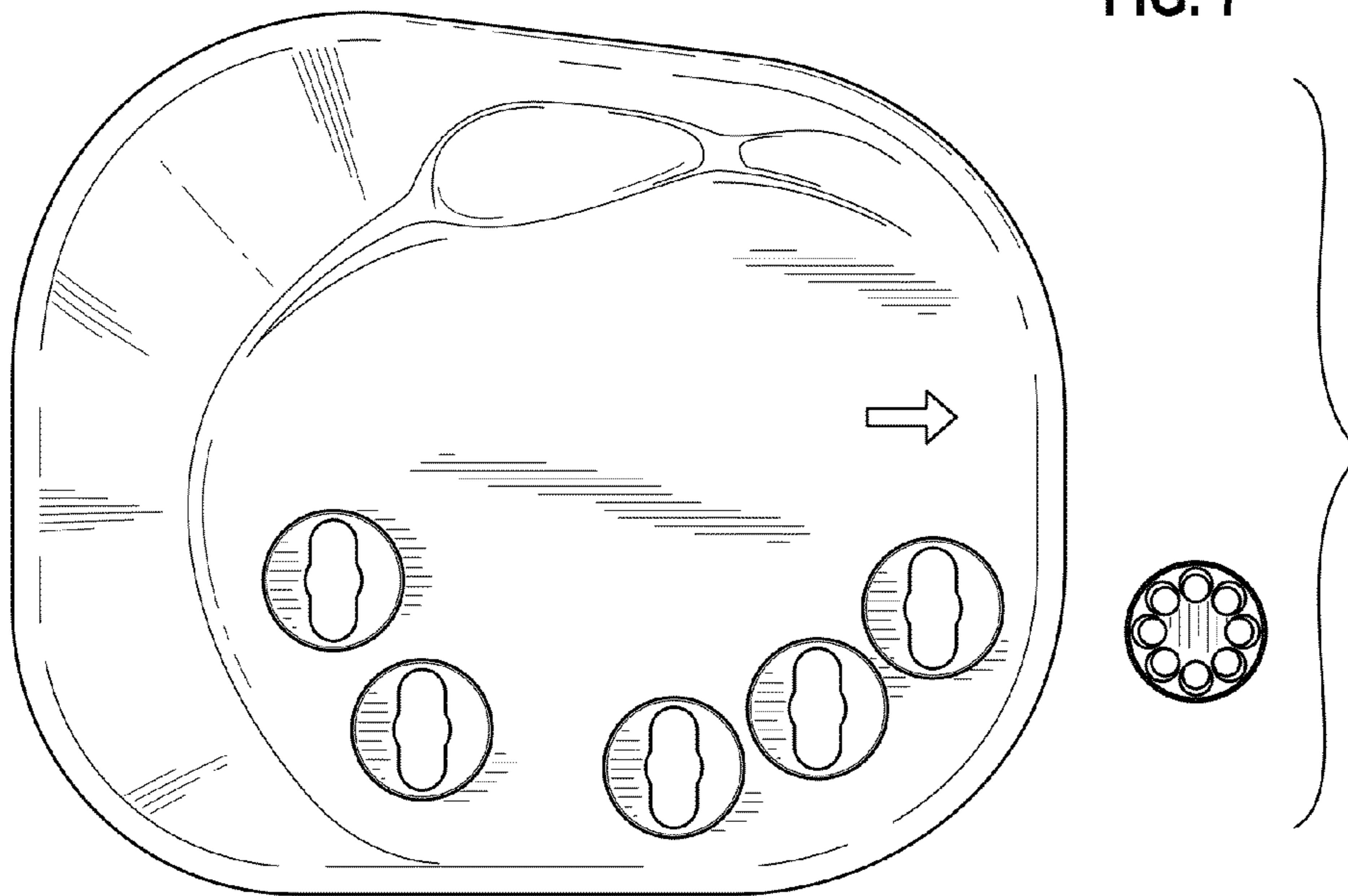

FIG. 8

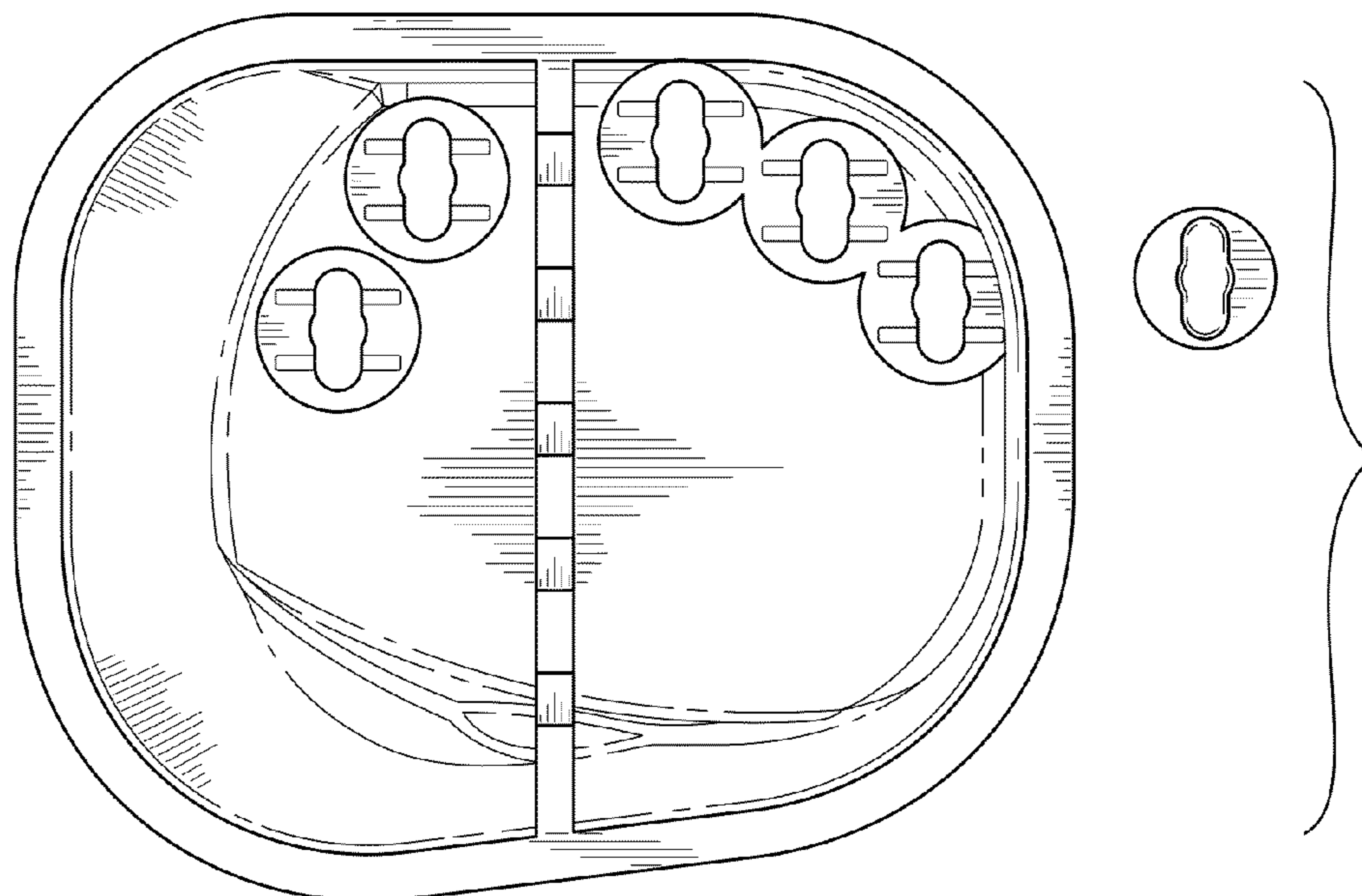

FIG. 9