



US00D757131S

(12) **United States Design Patent**
Lee et al.

(10) **Patent No.:** **US D757,131 S**
(45) **Date of Patent:** **** May 24, 2016**

(54) **REFRIGERATOR DOOR**

(71) Applicant: **LG ELECTRONICS INC.**, Seoul (KR)

(72) Inventors: **Hangbok Lee**, Seoul (KR); **Hongsik Kwon**, Seoul (KR); **Minsub Kim**, Seoul (KR); **Jungkyu Son**, Seoul (KR); **Eugene Suh**, Seoul (KR); **Junyi Heo**, Seoul (KR)

(73) Assignee: **LG ELECTRONICS INC.**, Seoul (KR)

(**) Term: **14 Years**

(21) Appl. No.: **29/522,088**

(22) Filed: **Mar. 27, 2015**

(30) **Foreign Application Priority Data**

Jan. 13, 2015 (KR) 30-2015-0001579

(51) **LOC (10) Cl.** **15-07**

(52) **U.S. Cl.**
USPC **D15/91**

(58) **Field of Classification Search**
USPC D15/79-91
CPC F25D 23/028; F25D 23/02; F25D 25/025;
F25D 23/00; F25D 2323/021; F25D 11/00;
F25D 2323/024; F25D 23/04; F25D 29/00;
F25D 25/02; F25D 25/024; F25D 27/005;
F25D 23/12; F25D 29/005; F25D 17/042;
F25D 2325/021

See application file for complete search history.

(56) **References Cited**

U.S. PATENT DOCUMENTS

D342,743	S	*	12/1993	Renner	D15/91
D497,069	S	*	10/2004	Aisley	D6/559
D702,742	S	*	4/2014	Hwan	D15/91
D707,735	S	*	6/2014	Cho	D15/91
D723,595	S	*	3/2015	You	D15/91
D730,958	S	*	6/2015	Choi	D15/91
D738,940	S	*	9/2015	Shin	D15/89
D738,941	S	*	9/2015	Shin	D15/91
D738,942	S	*	9/2015	Choi	D15/91

* cited by examiner

Primary Examiner — Daniel Bui

Assistant Examiner — Khawaja Anwar

(74) *Attorney, Agent, or Firm* — Birch, Stewart, Kolasch & Birch, LLP

(57) **CLAIM**

We claim the ornamental design for a refrigerator door, as shown and described.

DESCRIPTION

FIG. 1 is a perspective view of a refrigerator door showing our new design;
FIG. 2 is a front elevation view thereof;
FIG. 3 is a rear elevation view thereof;
FIG. 4 is a left-side elevation view thereof;
FIG. 5 is a right-side elevation view thereof;
FIG. 6 is a top plan view thereof;
FIG. 7 is a bottom plan view thereof; and,
FIG. 8 is a perspective view in a state of use thereof.
The broken lines in the drawing figures are included for the purpose of illustrating environment and form no part of the claimed design.

1 Claim, 7 Drawing Sheets

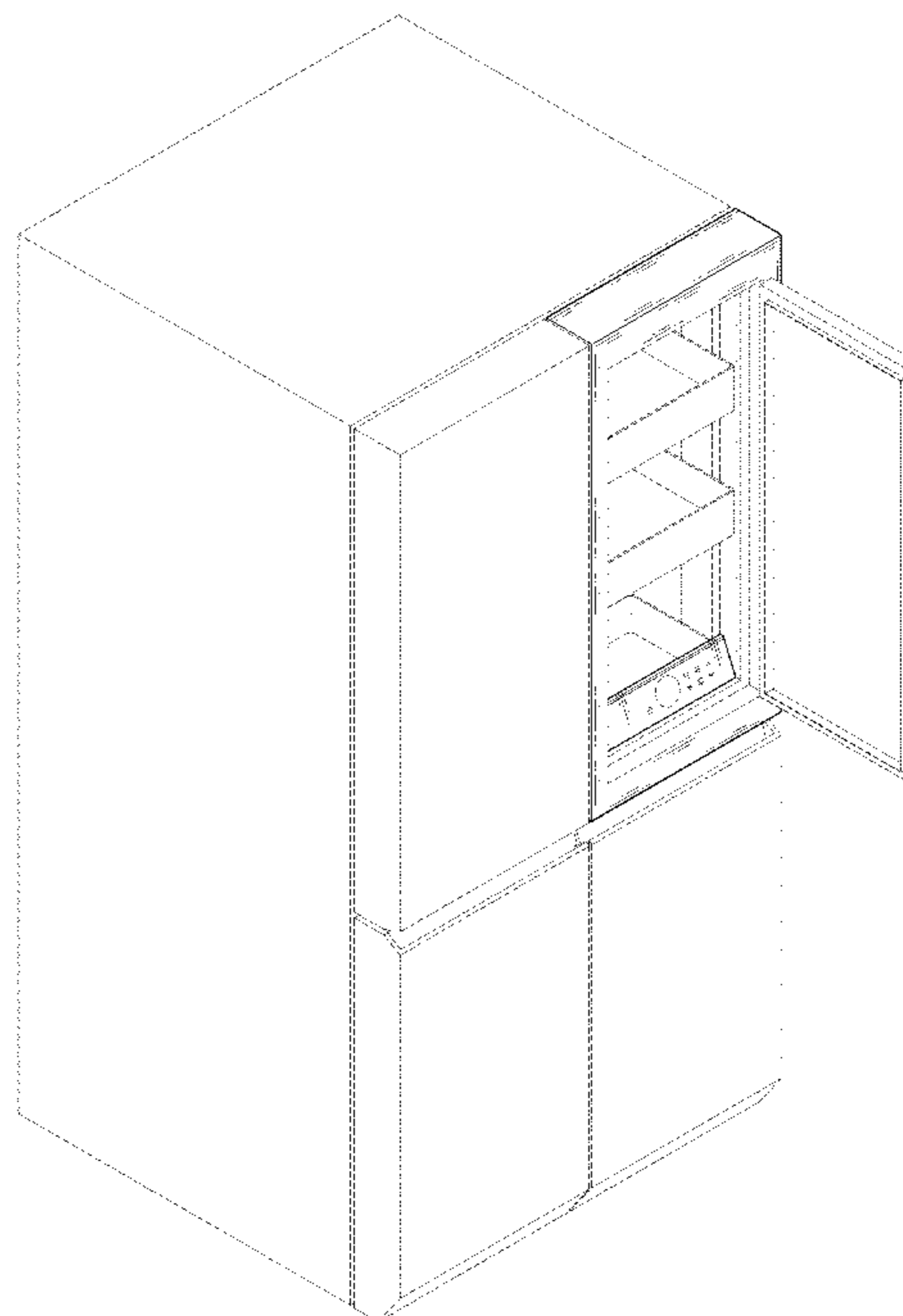
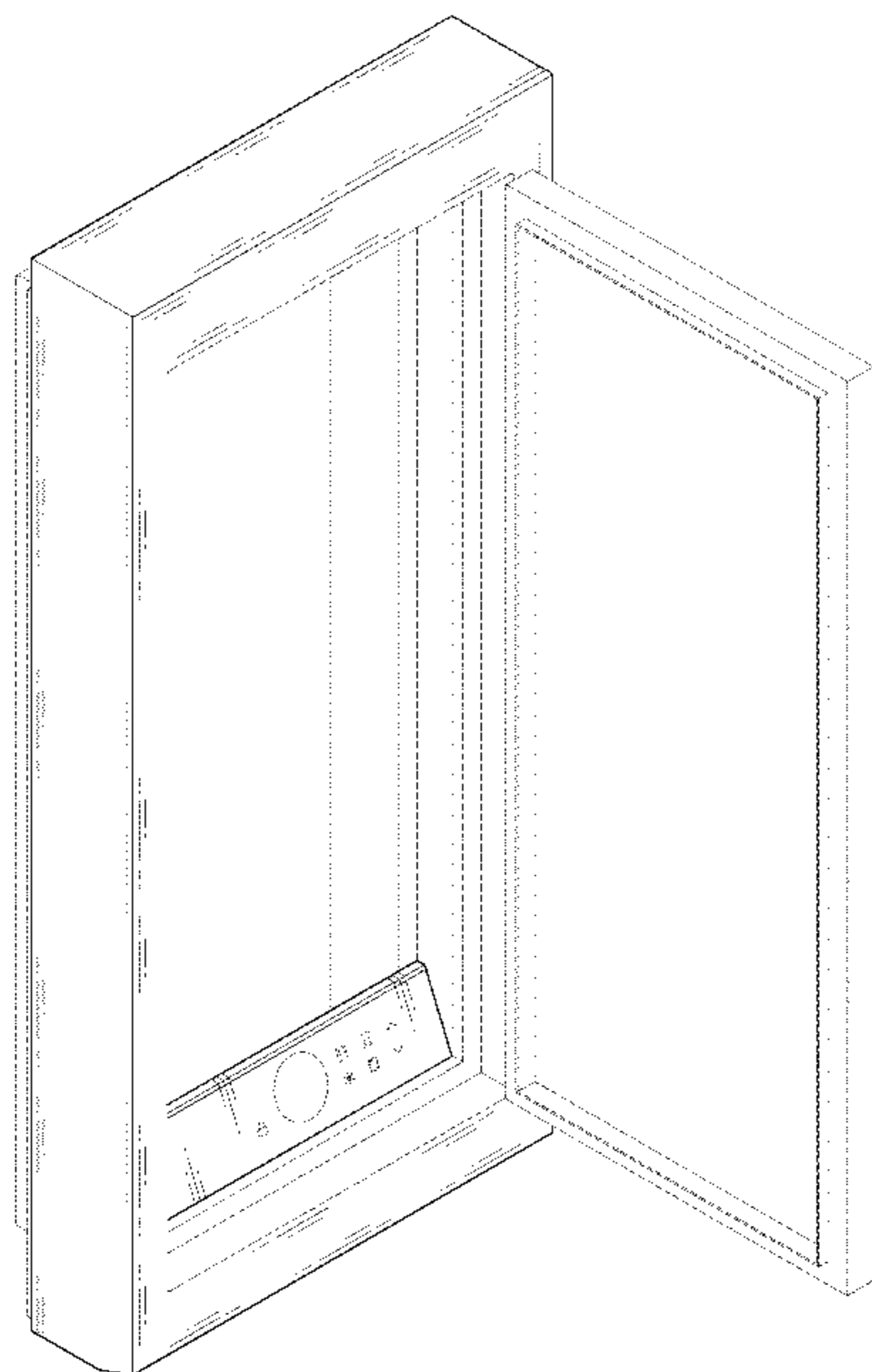

FIG. 1

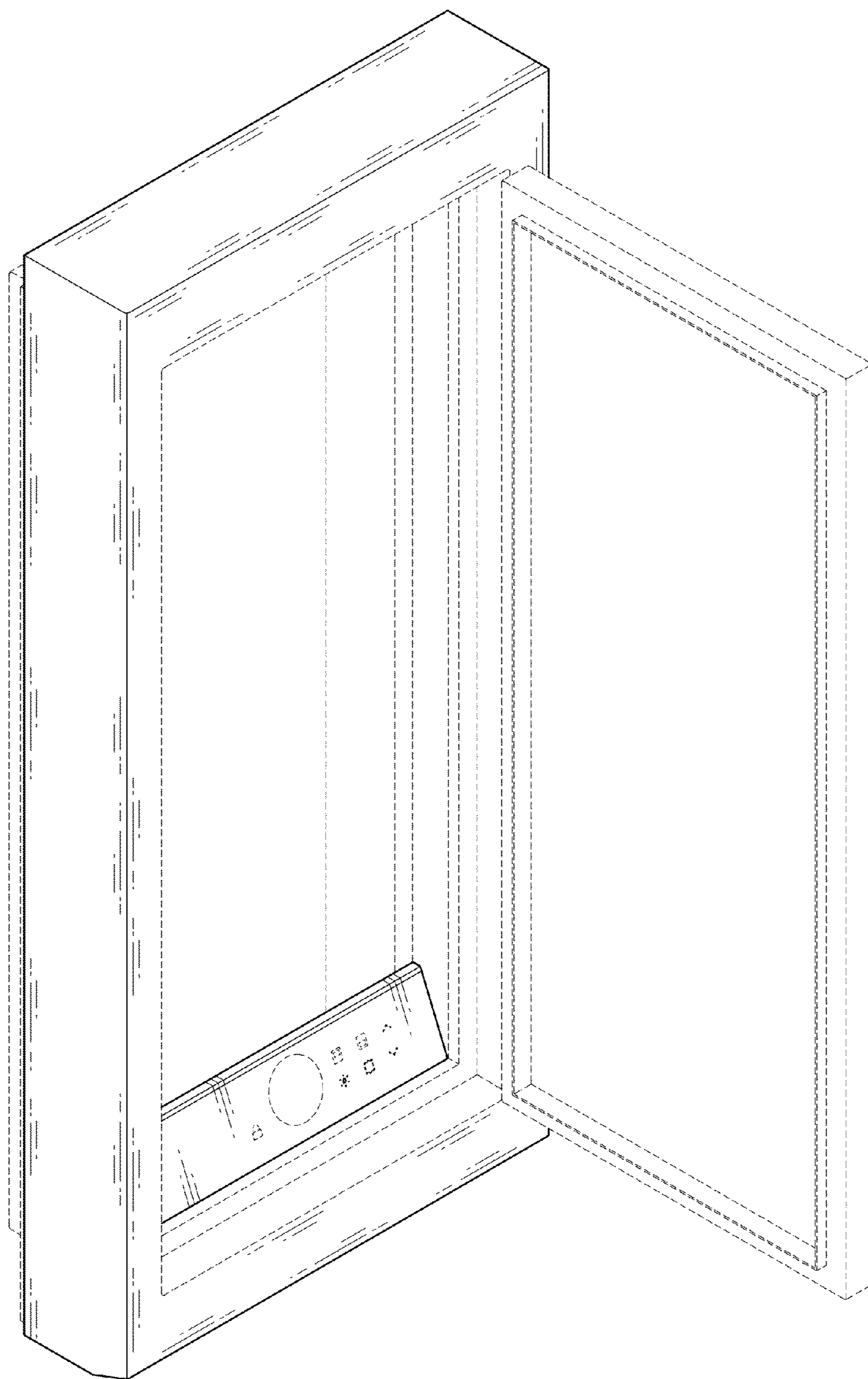

FIG. 2

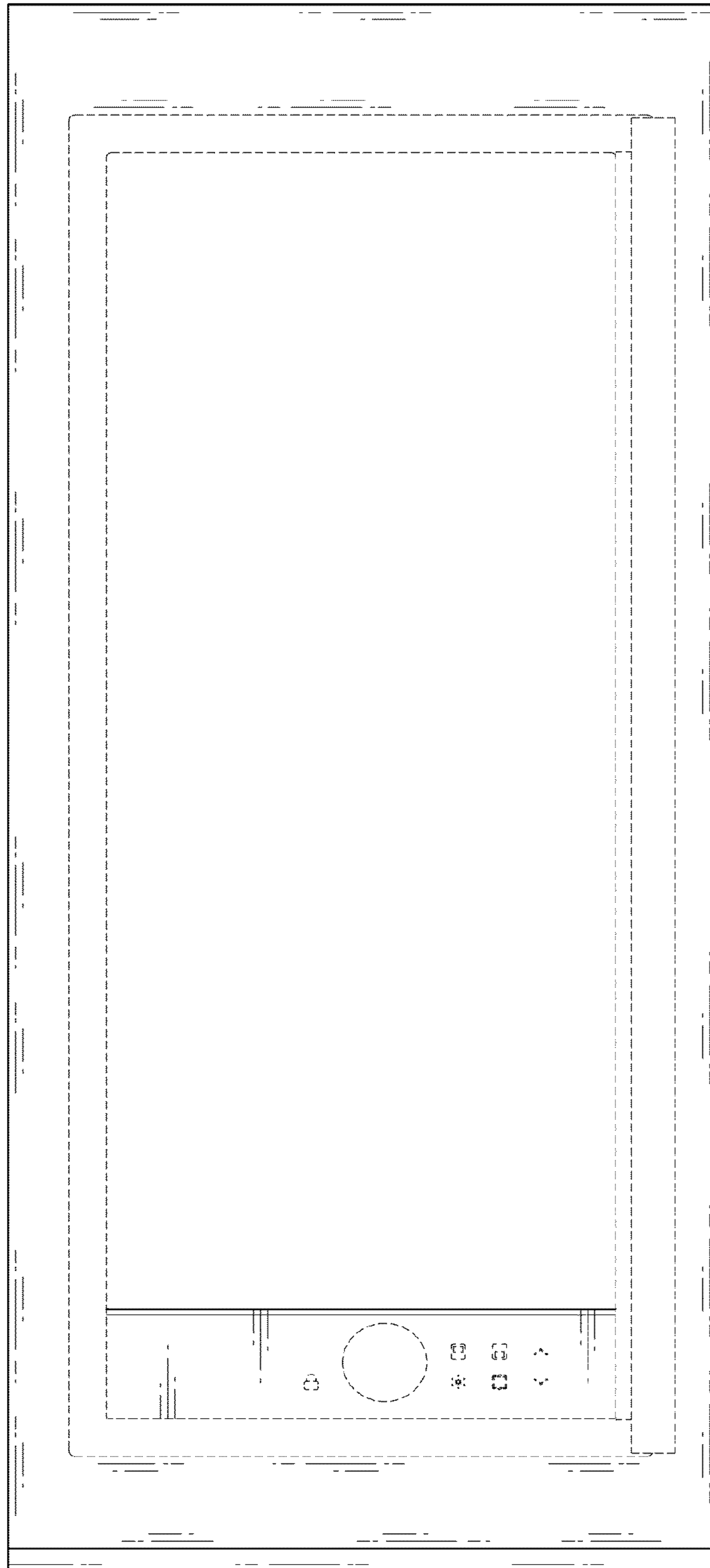

FIG. 3

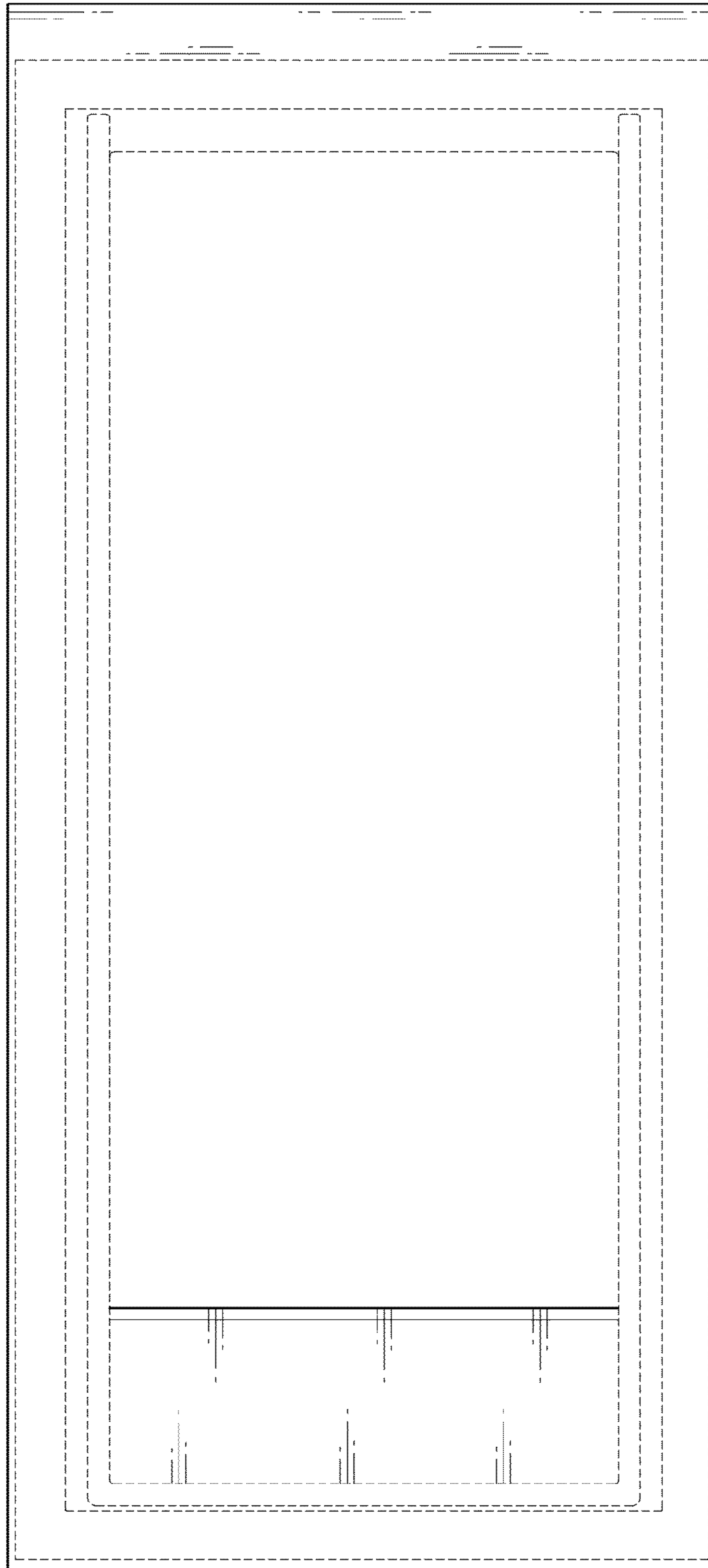

FIG. 4

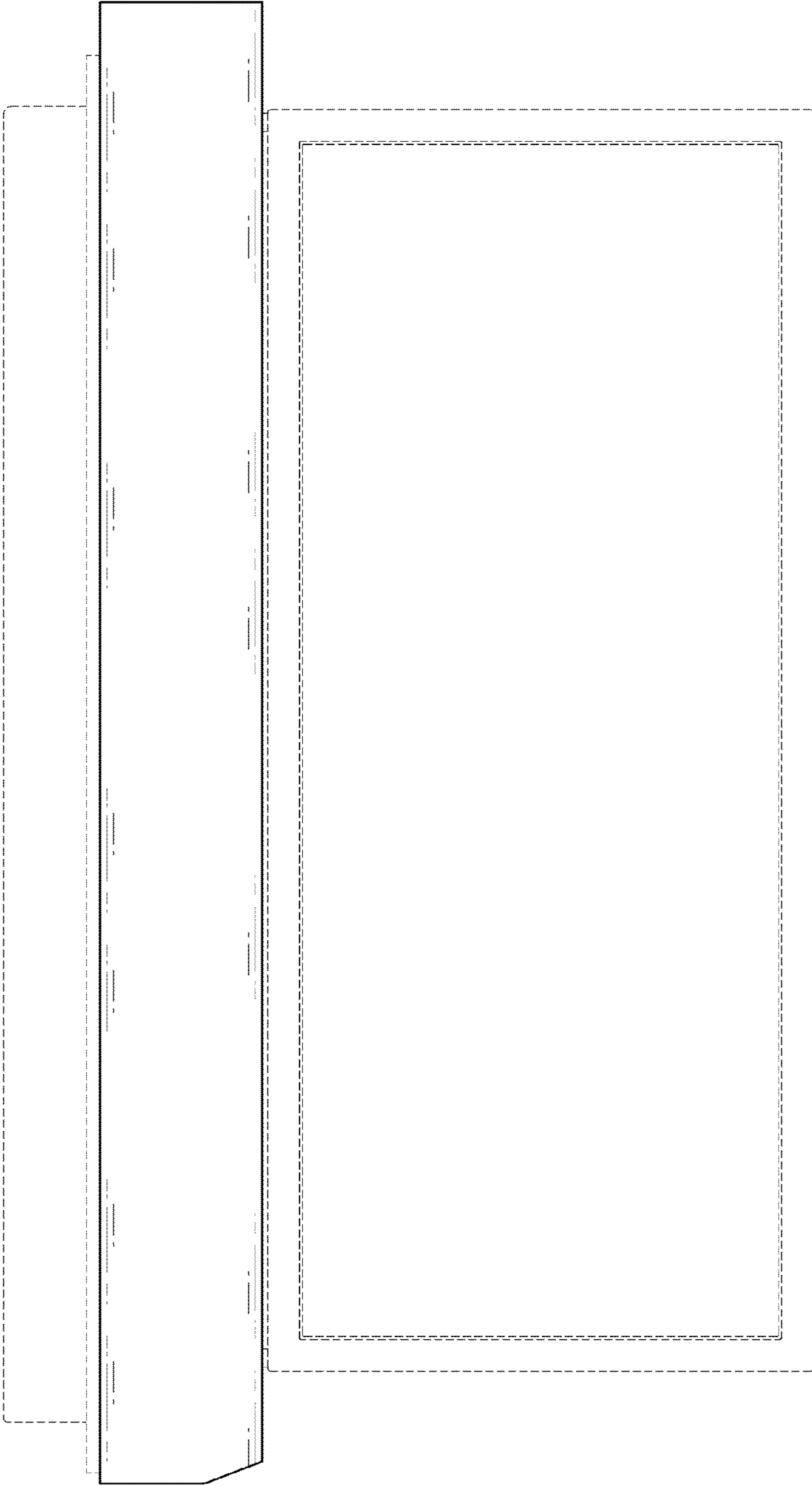

FIG. 5

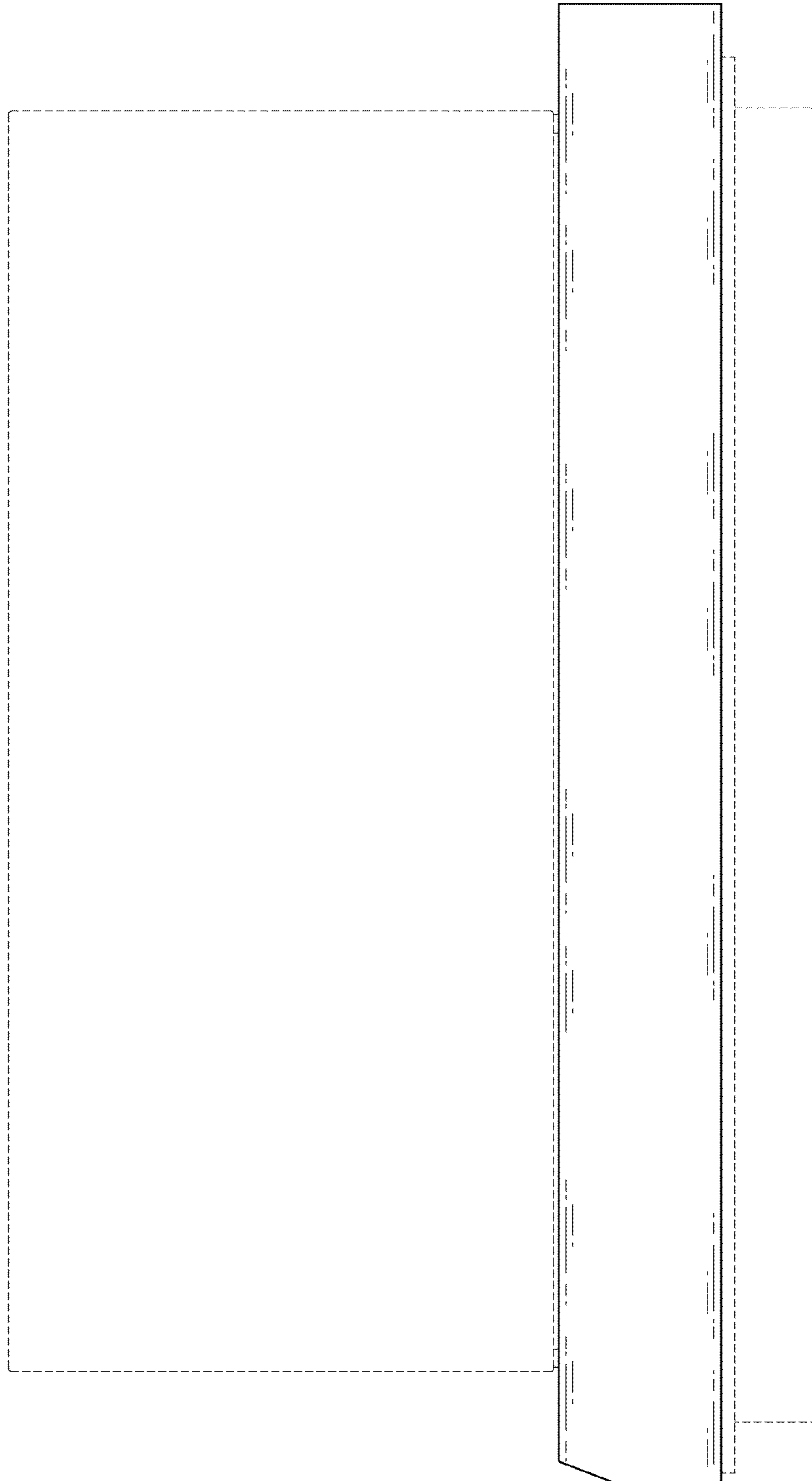

FIG. 6

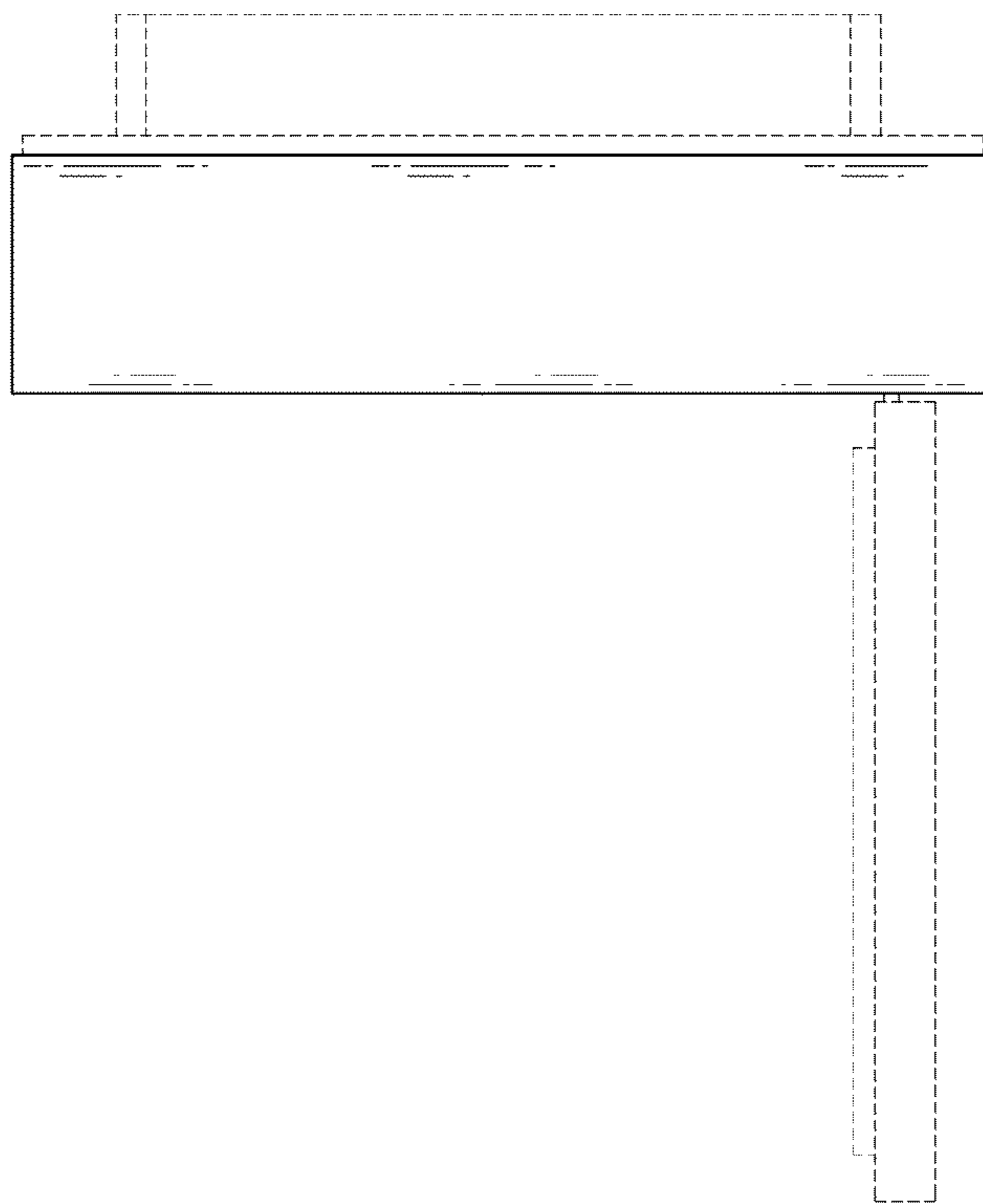

FIG. 7

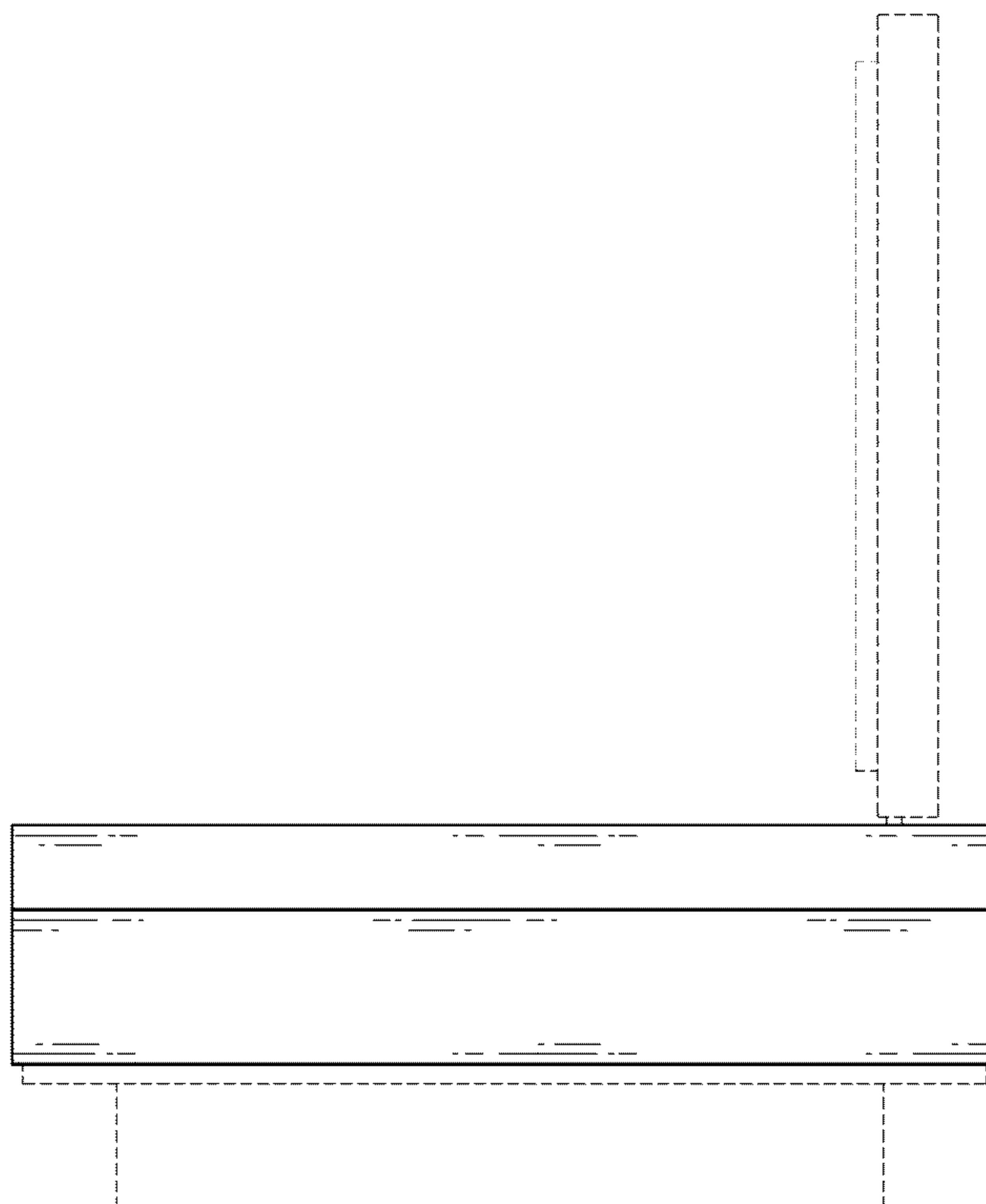

FIG. 8

