



US00D756794S

(12) **United States Design Patent**  
**Steward et al.**

(10) **Patent No.:** **US D756,794 S**

(45) **Date of Patent:** **\*\* May 24, 2016**

(54) **BOTTLE**

(71) Applicant: **The Coca-Cola Company**, Atlanta, GA (US)

(72) Inventors: **Sterling Lane Steward**, Douglasville, GA (US); **Christopher Michael Weston**, London (GB); **Matthew Stuart Garwood**, Cardiff (GB); **Simon Daniel**, London (GB)

(73) Assignee: **The Coca-Cola Company**, Atlanta, GA (US)

(\*\*) Term: **14 Years**

(21) Appl. No.: **29/466,578**

(22) Filed: **Sep. 9, 2013**

(51) **LOC (10) Cl.** ..... **09-01**

(52) **U.S. Cl.**  
USPC ..... **D9/538**; D9/539; D9/550; D9/556

(58) **Field of Classification Search**  
USPC ..... D9/500, 502–505, 516, 520, 530, D9/537–545, 548–550, 556, 558, 652, 715, D9/719; 215/370, 371, 375, 379, 381–384; 220/660, 669–671, 674–675  
CPC ..... B65D 1/00; B65D 1/02; B65D 1/0223; B65D 1/0284; B65D 23/00; B65D 23/001; B65D 83/00; B65D 91/00; B65D 91/02; B65D 2501/00; B65D 2501/0009  
See application file for complete search history.

(56) **References Cited**

**U.S. PATENT DOCUMENTS**

D63,657 S \* 12/1923 Root ..... D9/538  
1,635,070 A \* 7/1927 Clark ..... B65D 1/06  
215/2  
1,891,794 A \* 12/1932 Bobrick ..... B65D 47/06  
215/387  
D105,529 S \* 8/1937 Kelly ..... D9/539  
D133,559 S \* 8/1942 Meyer ..... D9/538  
D196,389 S \* 9/1963 Masen et al. .... D9/538  
3,871,541 A \* 3/1975 Adomaitis ..... 215/375

D383,677 S \* 9/1997 Darr ..... D9/520  
5,735,421 A \* 4/1998 Deemer et al. .... 215/382  
6,112,925 A \* 9/2000 Nahill et al. .... 215/382  
6,467,620 B1 \* 10/2002 Heckman et al. .... 206/459.5  
D567,663 S \* 4/2008 Kinmont et al. .... D9/550  
D577,291 S \* 9/2008 Kinmont et al. .... D9/516  
D582,290 S \* 12/2008 Dimmel et al. .... D9/550  
D592,455 S \* 5/2009 Germann ..... D7/510  
8,186,529 B2 \* 5/2012 Kinmont et al. .... 215/383  
D710,206 S \* 8/2014 Rajesh et al. .... D9/538  
D719,033 S \* 12/2014 Kaddari ..... D9/668  
D736,628 S \* 8/2015 Fleischhacker ..... D9/500  
2008/0257855 A1 \* 10/2008 Patel ..... 215/370

\* cited by examiner

*Primary Examiner* — Dana L Meyrow

(74) *Attorney, Agent, or Firm* — McAndrews Held & Malloy, Ltd.

(57) **CLAIM**

The ornamental design for a bottle, as shown and described.

**DESCRIPTION**

FIG. 1 is a perspective view of a first embodiment of a bottle showing our new design;  
FIG. 2 is a front elevation view thereof;  
FIG. 3 is a rear elevation view thereof;  
FIG. 4 is a right-side elevation view thereof;  
FIG. 5 is a left-side elevation view thereof;  
FIG. 6 is a top plan view thereof;  
FIG. 7 is a bottom plan view thereof;  
FIG. 8 is a perspective view of a further embodiment of a bottle showing our new design;  
FIG. 9 is a front elevation view thereof;  
FIG. 10 is a rear elevation view thereof;  
FIG. 11 is a right-side elevation view thereof;  
FIG. 12 is a left-side elevation view thereof;  
FIG. 13 is a top plan view thereof;  
FIG. 14 is a bottom plan view thereof;  
FIG. 15 is a perspective view of a further embodiment of a bottle showing our new design;  
FIG. 16 is a front elevation view thereof;  
FIG. 17 is a rear elevation view thereof;  
FIG. 18 is a right-side elevation view thereof;  
FIG. 19 is a left-side elevation view thereof;

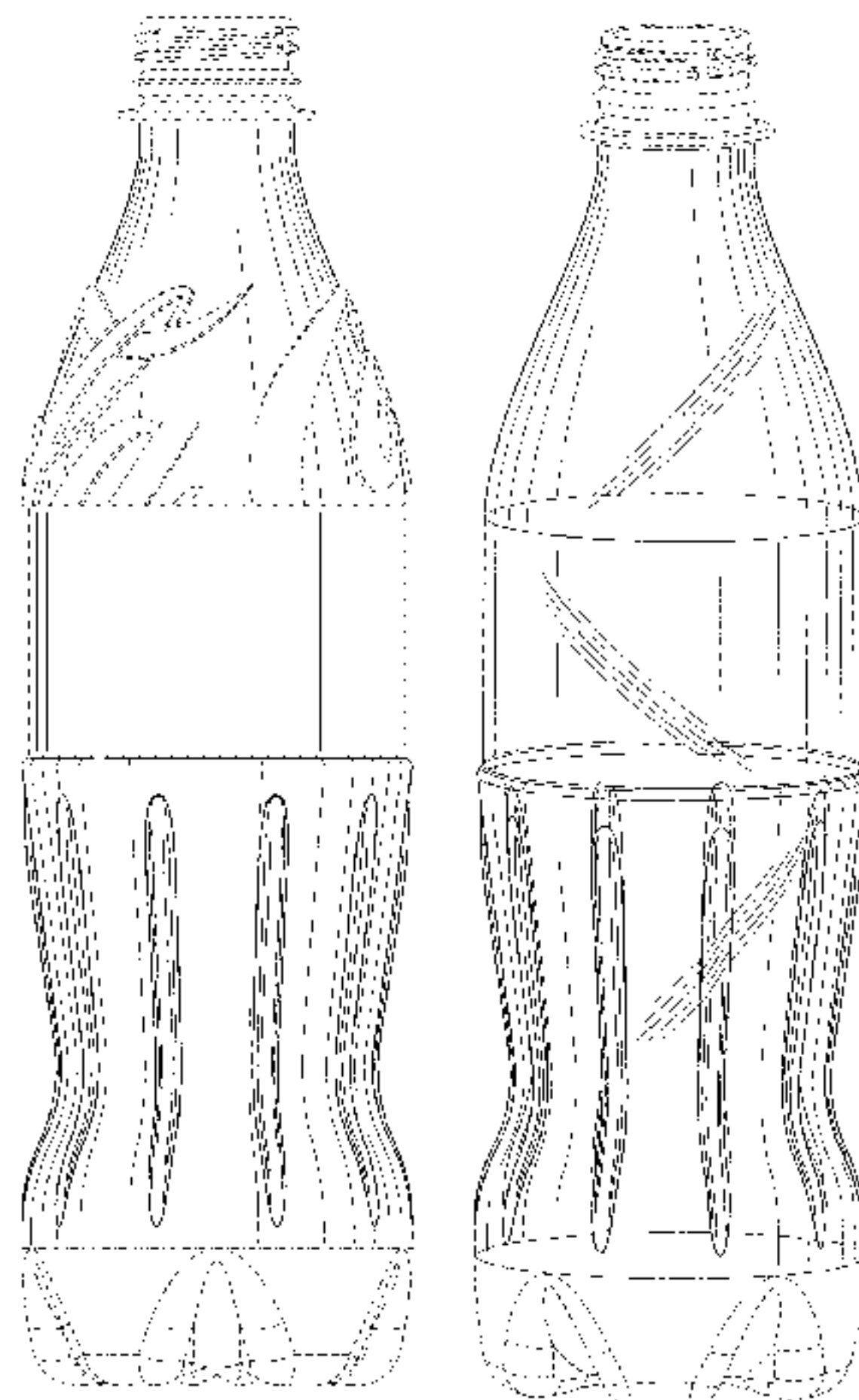

FIG. 20 is a top plan view thereof;  
FIG. 21 is a bottom plan view thereof;  
FIG. 22 is a perspective view of a further embodiment of a bottle showing our new design;  
FIG. 23 is a front elevation view thereof;  
FIG. 24 is a rear elevation view thereof;  
FIG. 25 is a right-side elevation view thereof;  
FIG. 26 is a left-side elevation view thereof;  
FIG. 27 is a top plan view thereof;  
FIG. 28 is a bottom plan view thereof;  
FIG. 29 is a perspective view of a further embodiment of a bottle showing our new design;  
FIG. 30 is a front elevation view thereof;  
FIG. 31 is a rear elevation view thereof;  
FIG. 32 is a right-side elevation view thereof;  
FIG. 33 is a left-side elevation view thereof;  
FIG. 34 is a top plan view thereof;  
FIG. 35 is a bottom plan view thereof;

FIG. 36 is a perspective view of a further embodiment of a bottle showing our new design;  
FIG. 37 is a front elevation view thereof;  
FIG. 38 is a rear elevation view thereof;  
FIG. 39 is a right-side elevation view thereof;  
FIG. 40 is a left-side elevation view thereof;  
FIG. 41 is a top plan view thereof; and,  
FIG. 42 is a bottom plan view thereof.

The dot-dash broken lines in the drawings define the bounds of the claimed design and form no part thereof. The evenly dashed broken lines in the drawings illustrate portions of the bottle that form no part of the claimed design.

The oblique line shading shown in Embodiments 3-6 (FIGS. 15-42) is used to denote claimed surfaces of the bottle that are transparent; in these embodiments, except for in FIGS. 15, 22, 29, and 36, the details of the opposing sides as seen through the claimed transparent surfaces of the bottle have not been shown for ease of illustration and understanding.

**1 Claim, 24 Drawing Sheets**

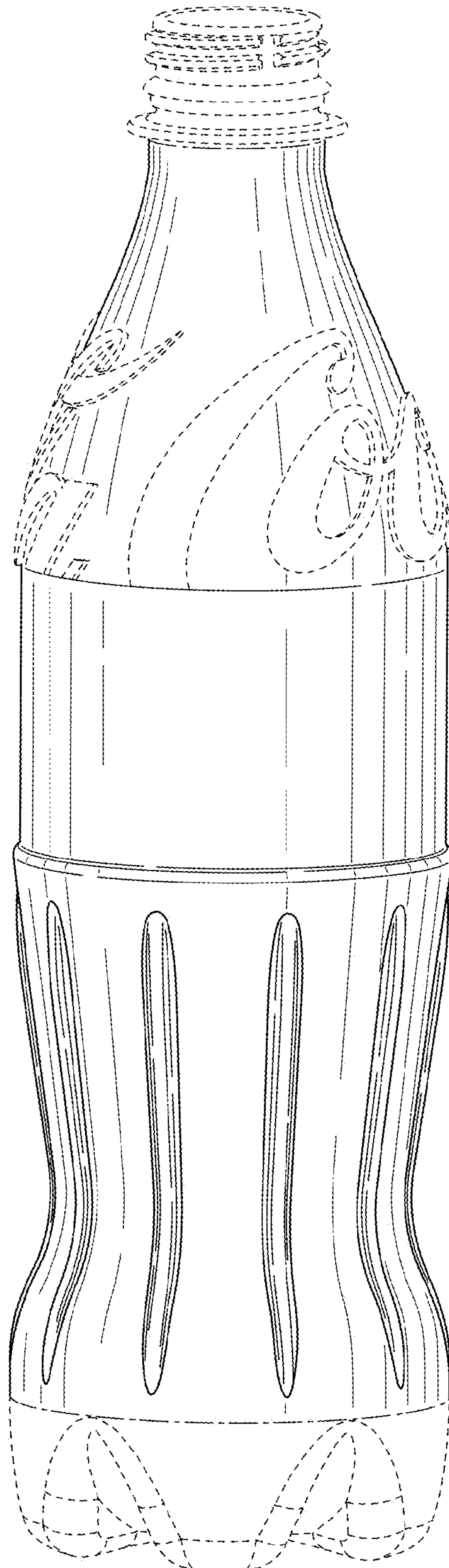

FIG. 1



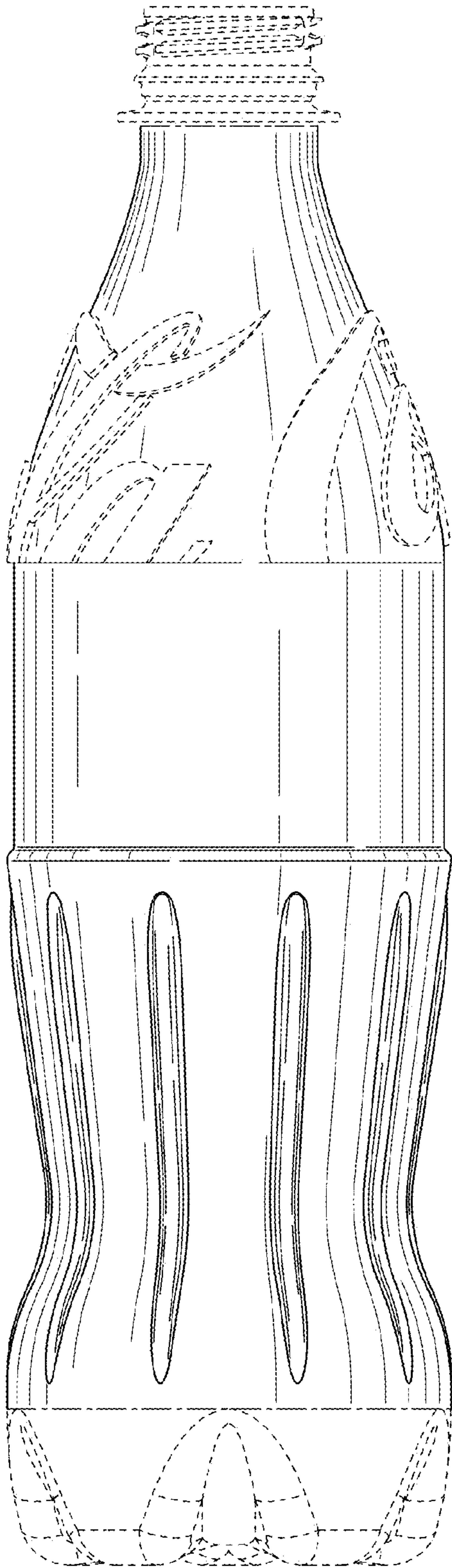

FIG. 2

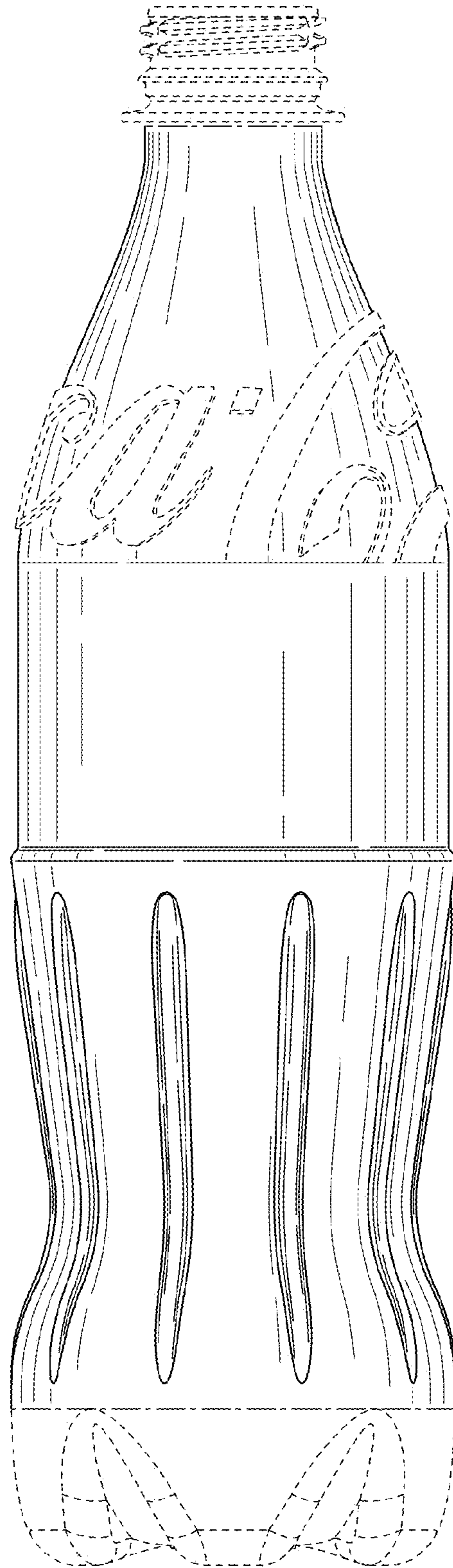

FIG. 3

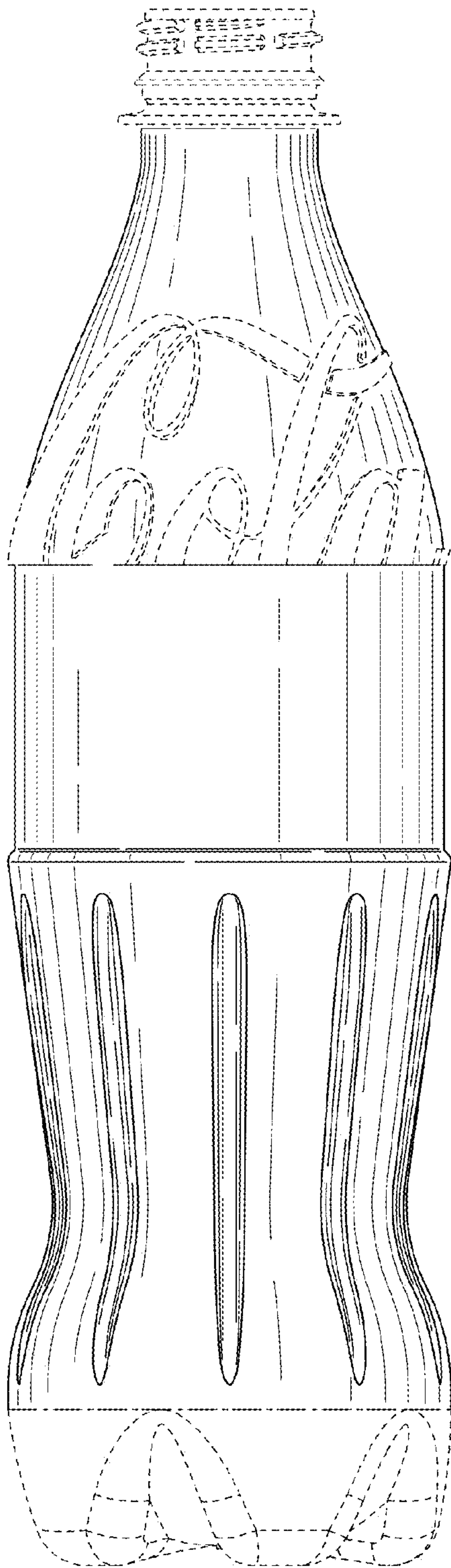

FIG. 4

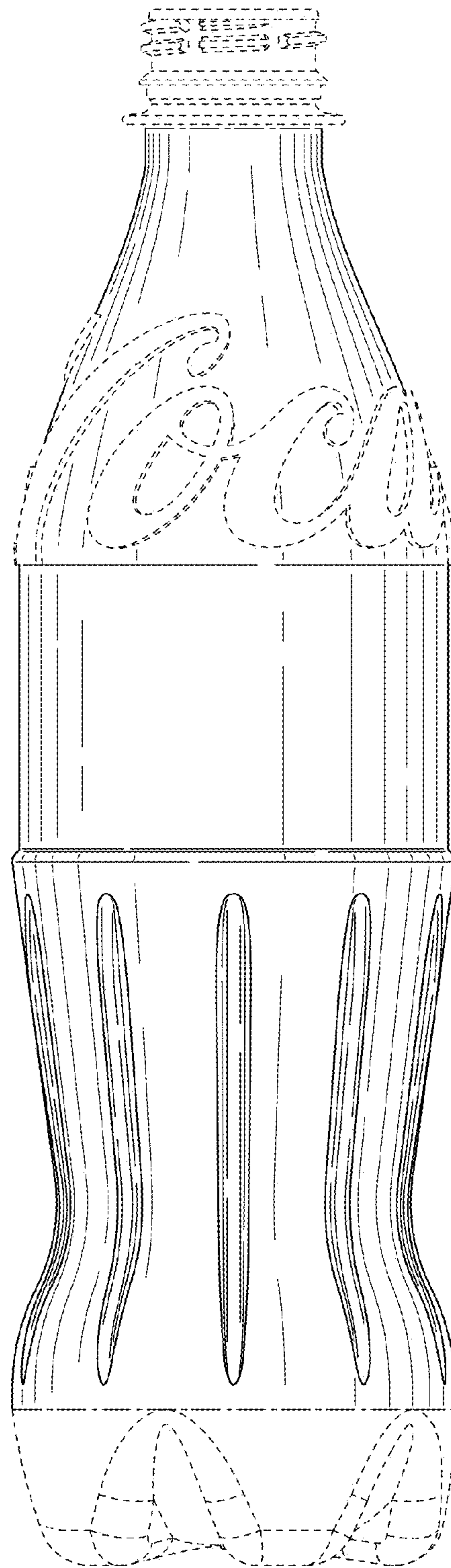

FIG. 5

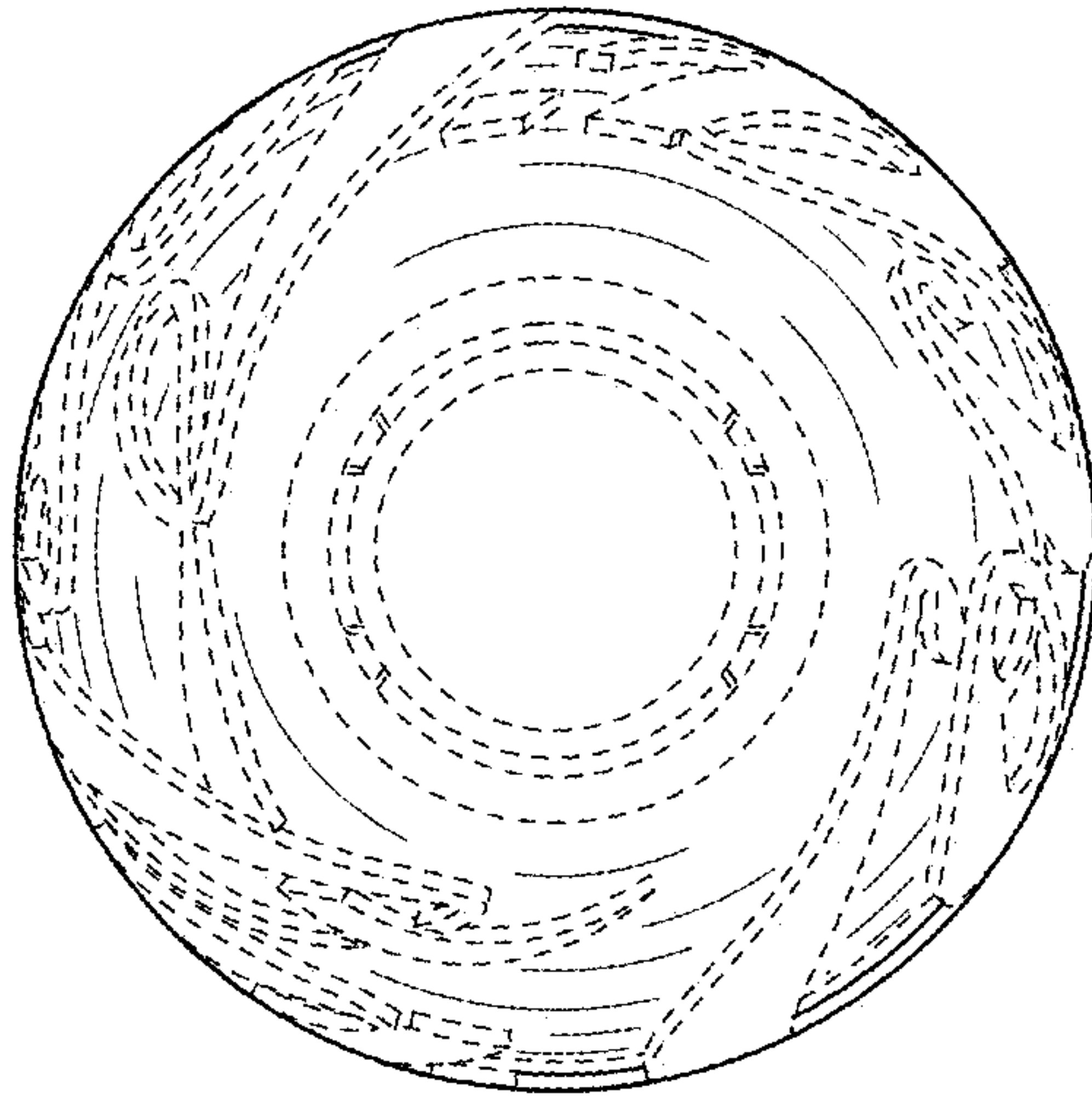

FIG. 6

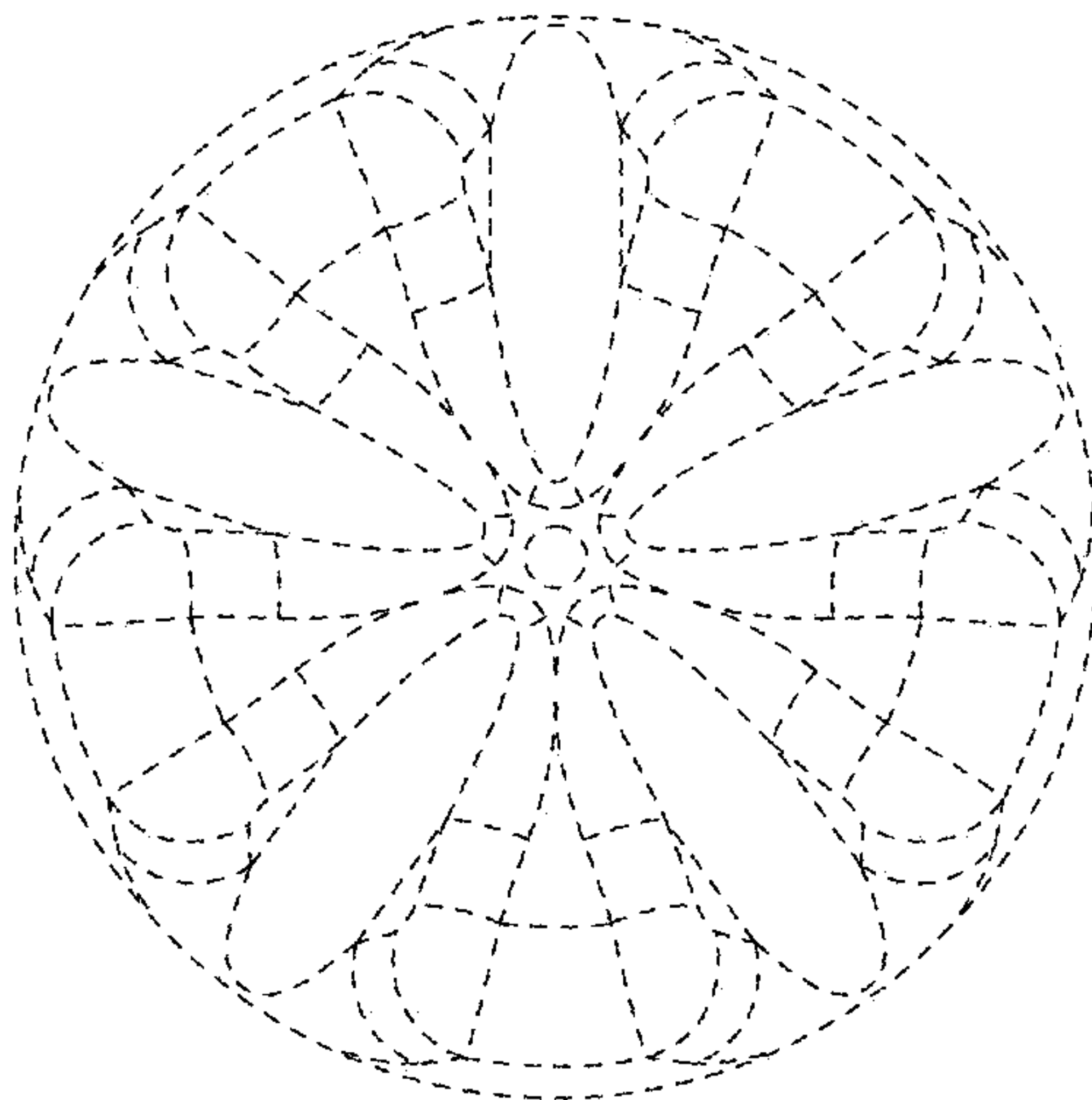

FIG. 7

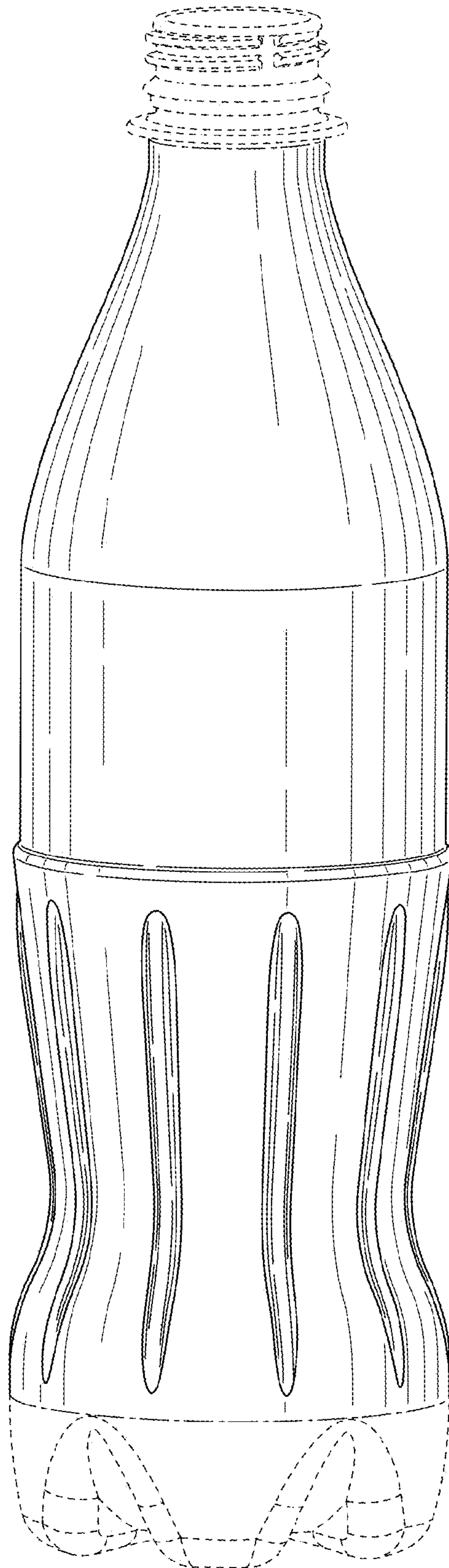

FIG. 8



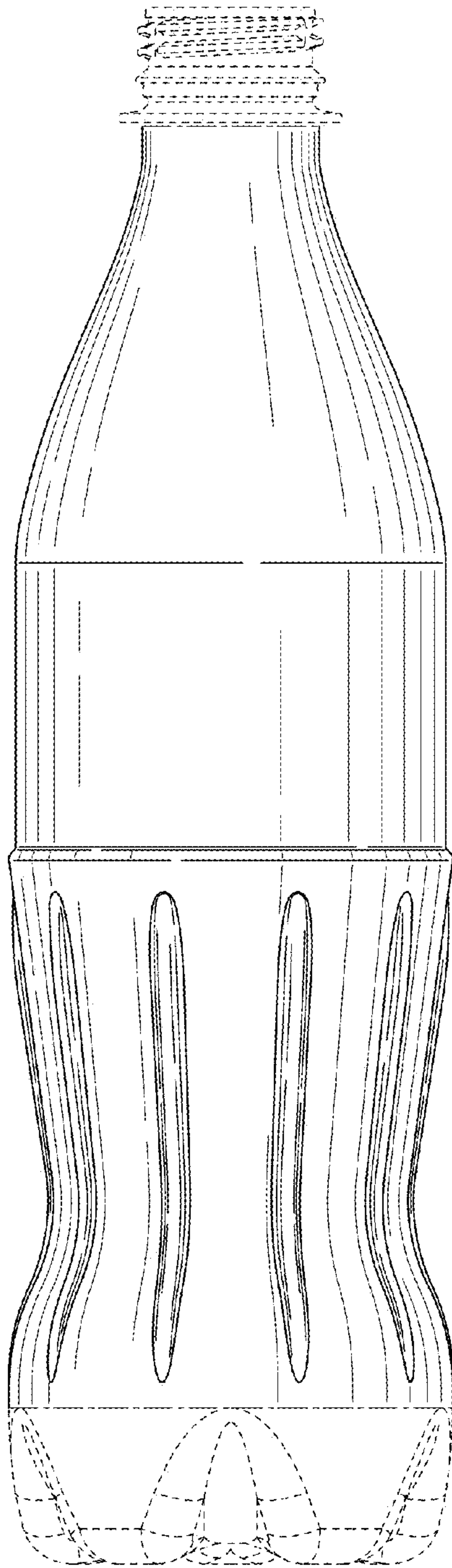

FIG. 9

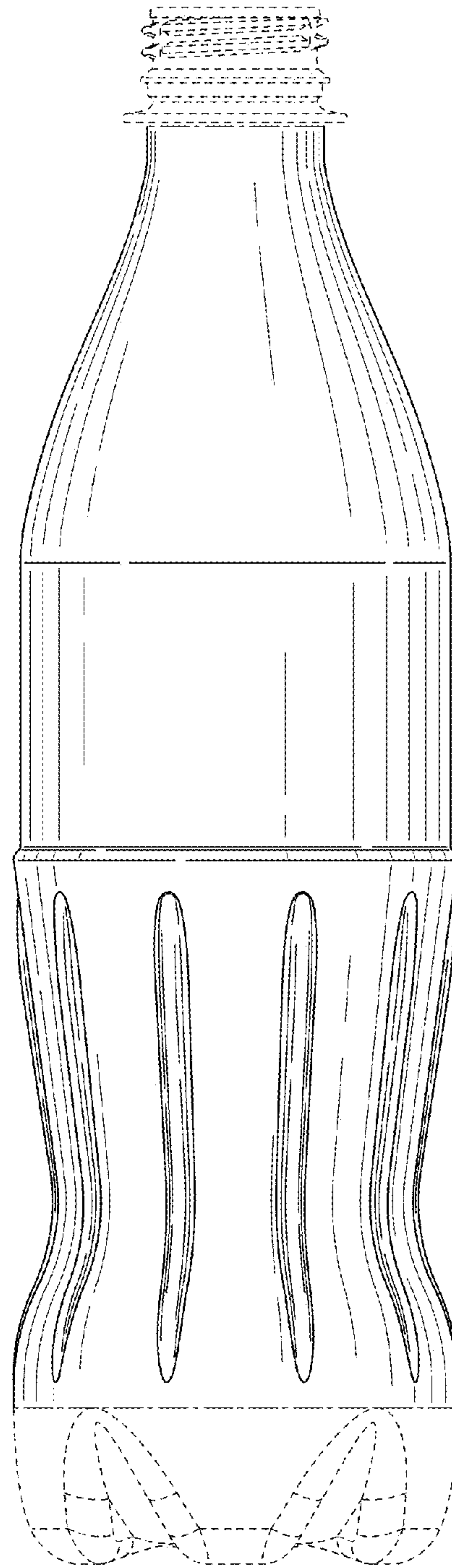

FIG. 10



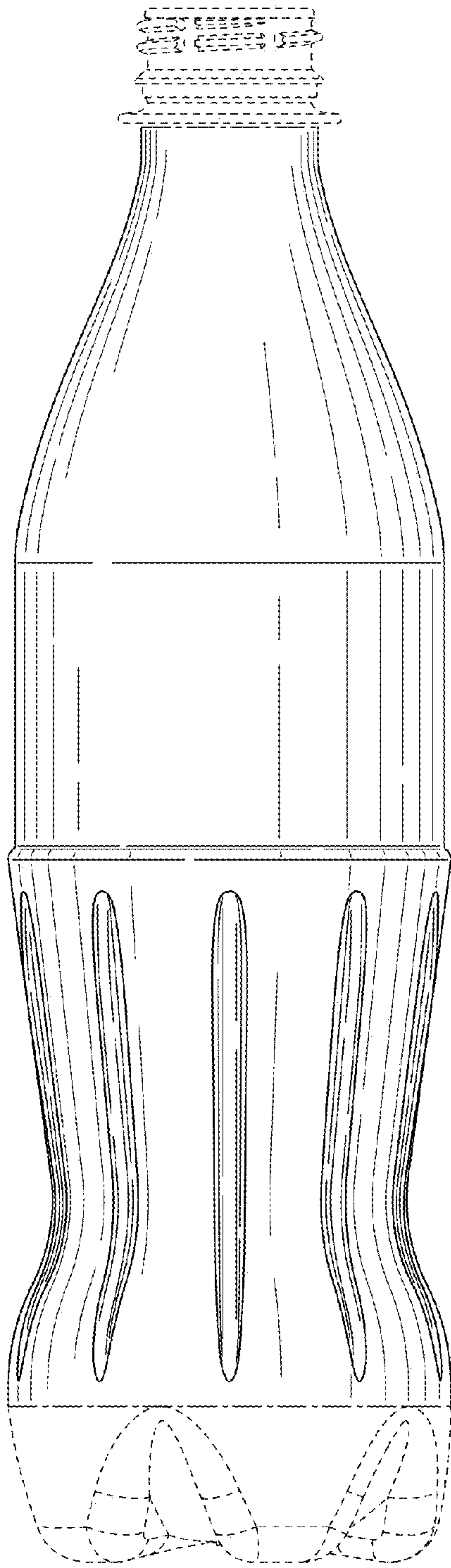

FIG. 11

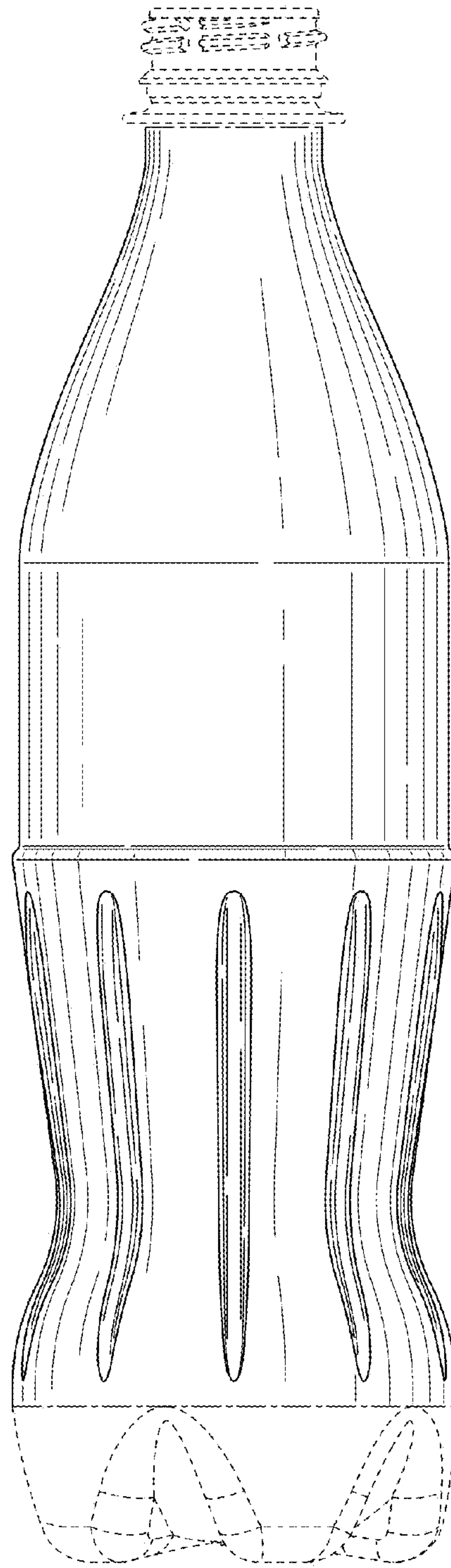

FIG. 12

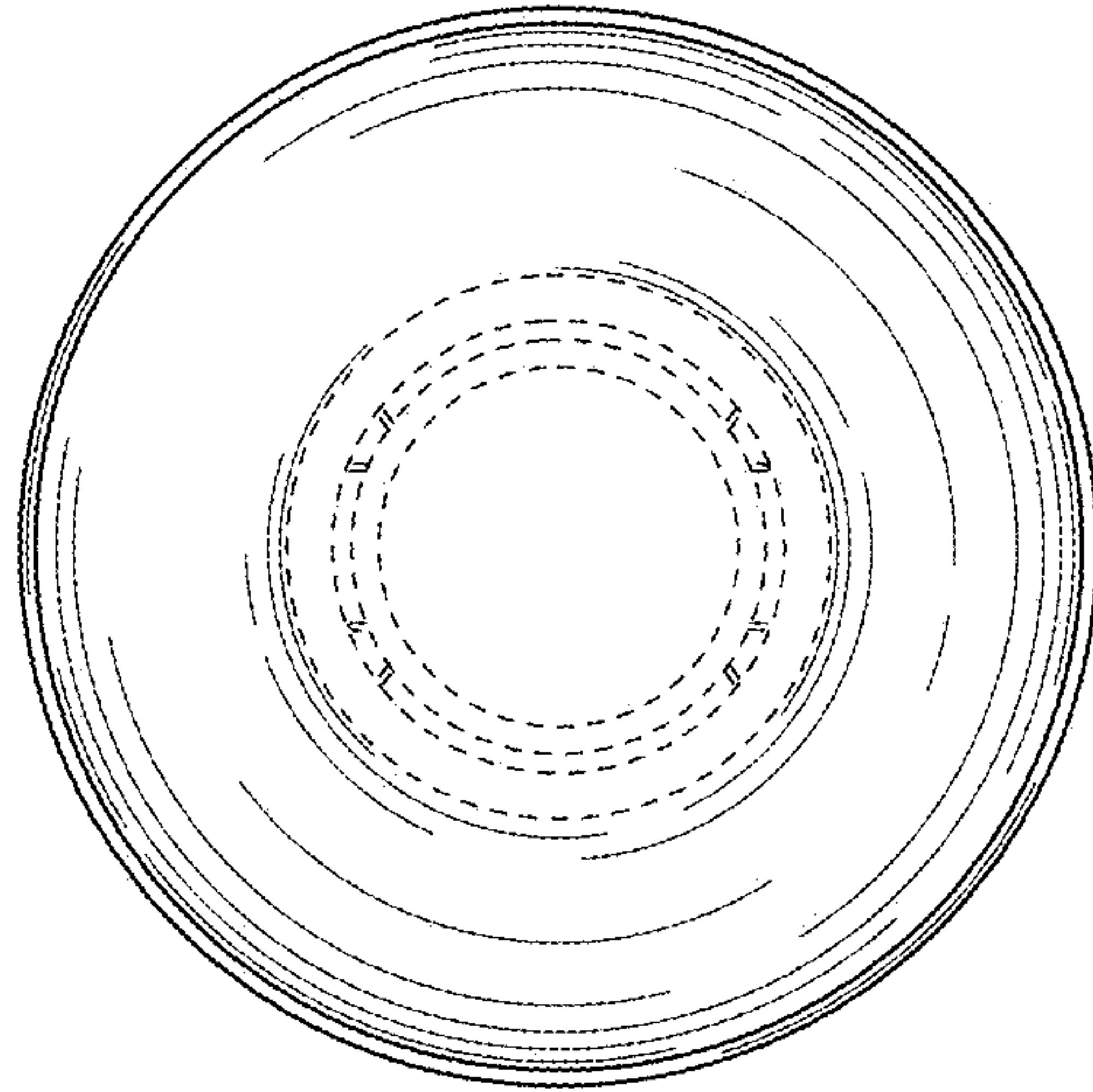

FIG. 13

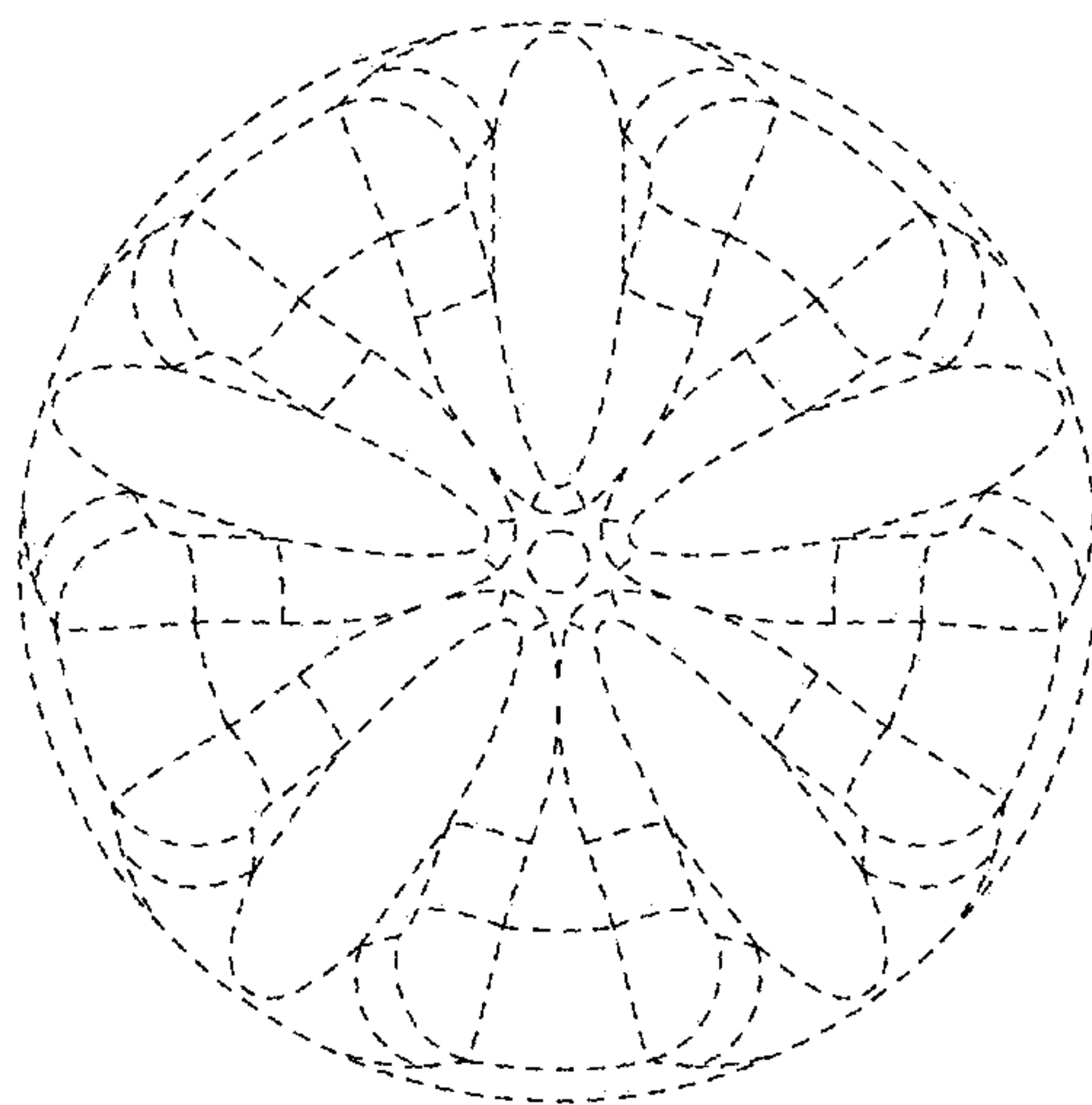

FIG. 14

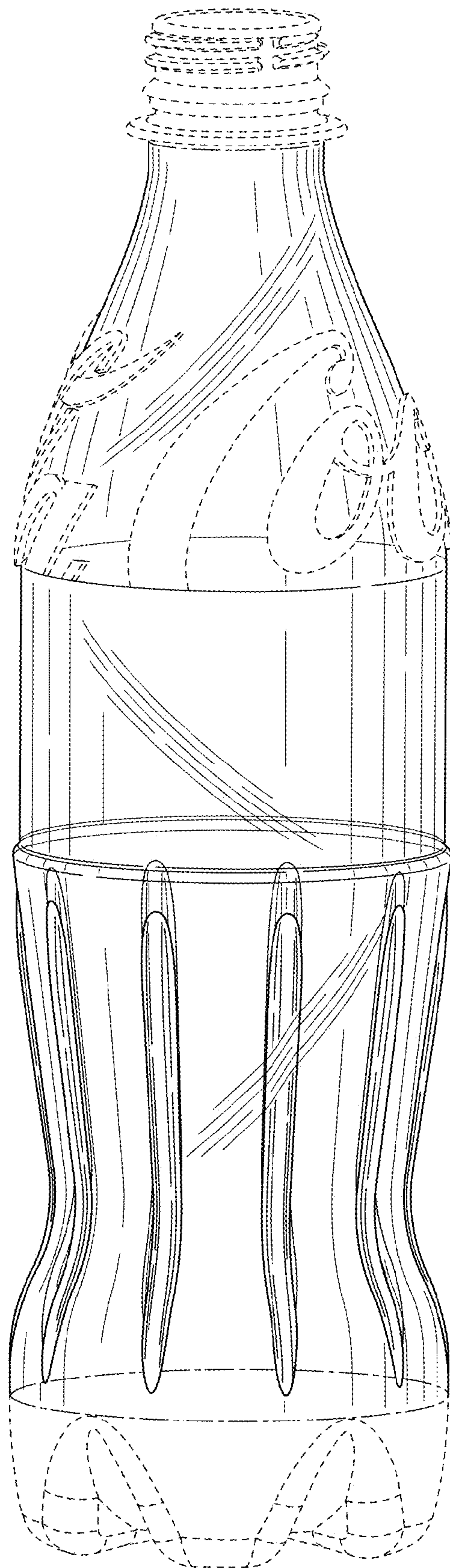

FIG. 15



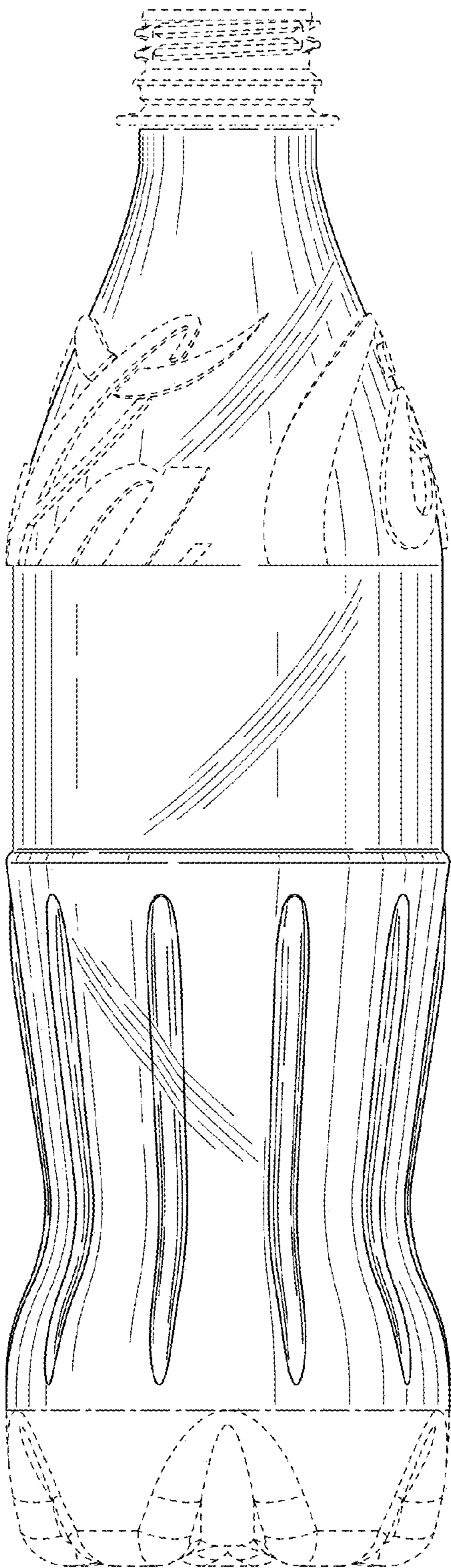

FIG. 16

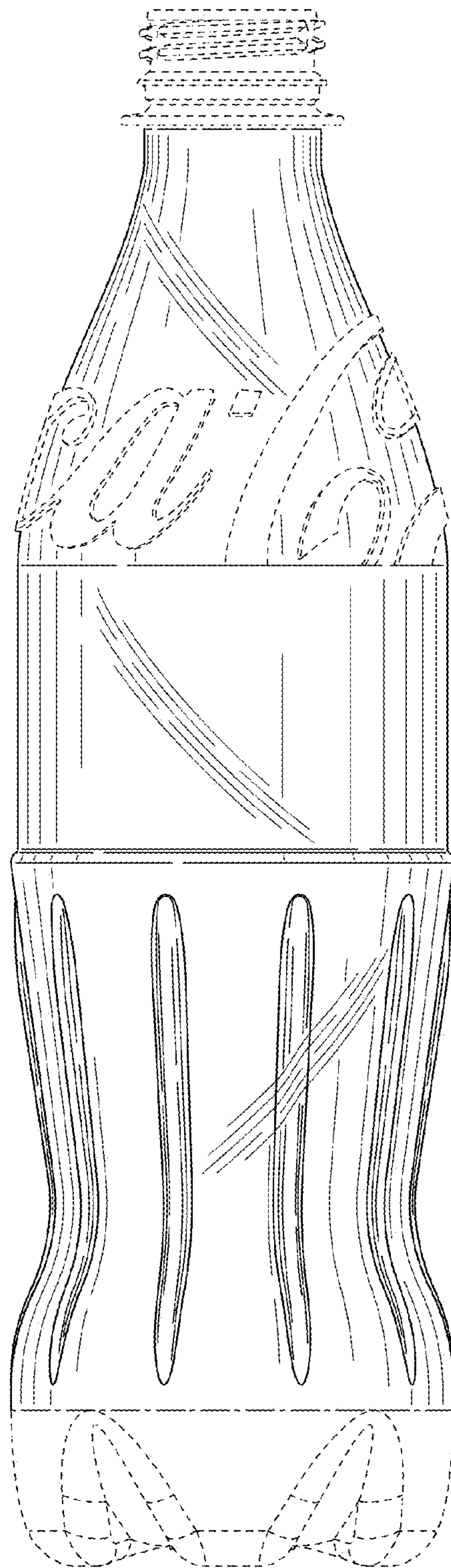

FIG. 17

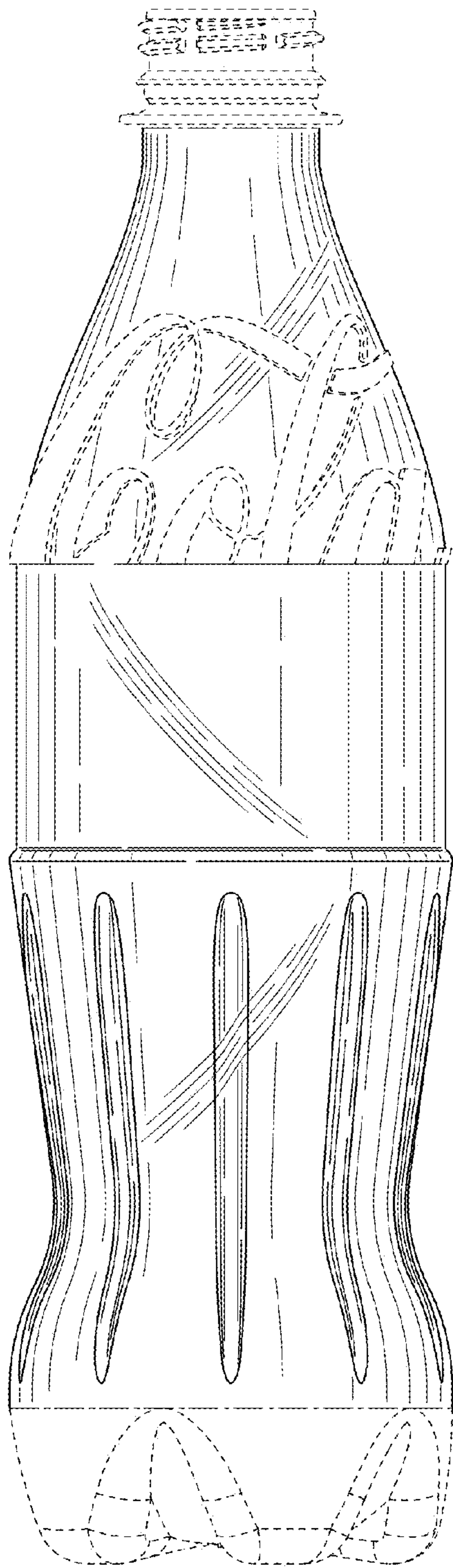

FIG. 18

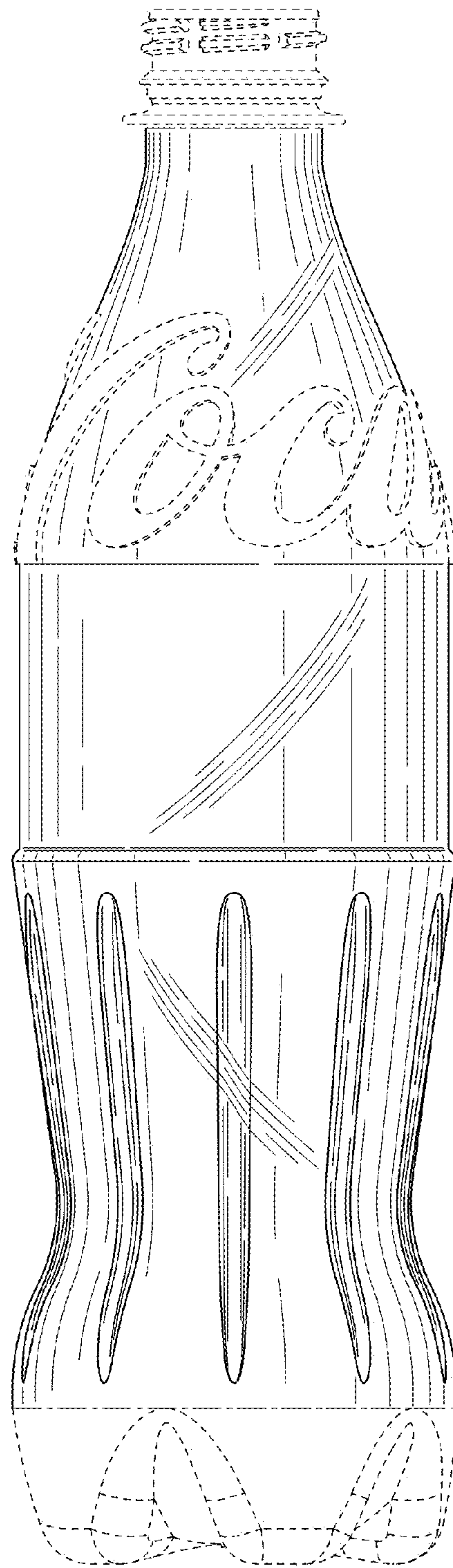

FIG. 19

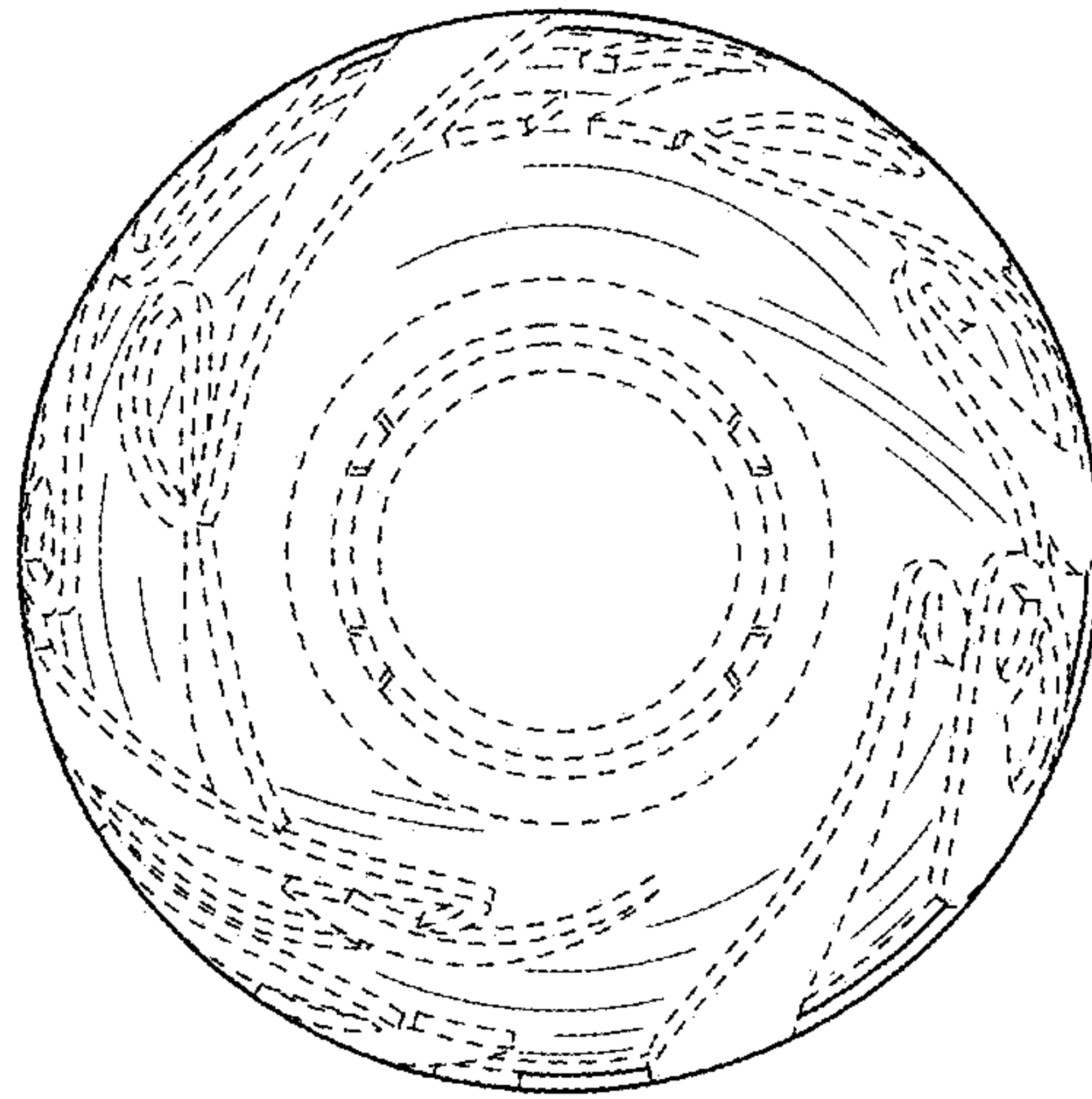

FIG. 20

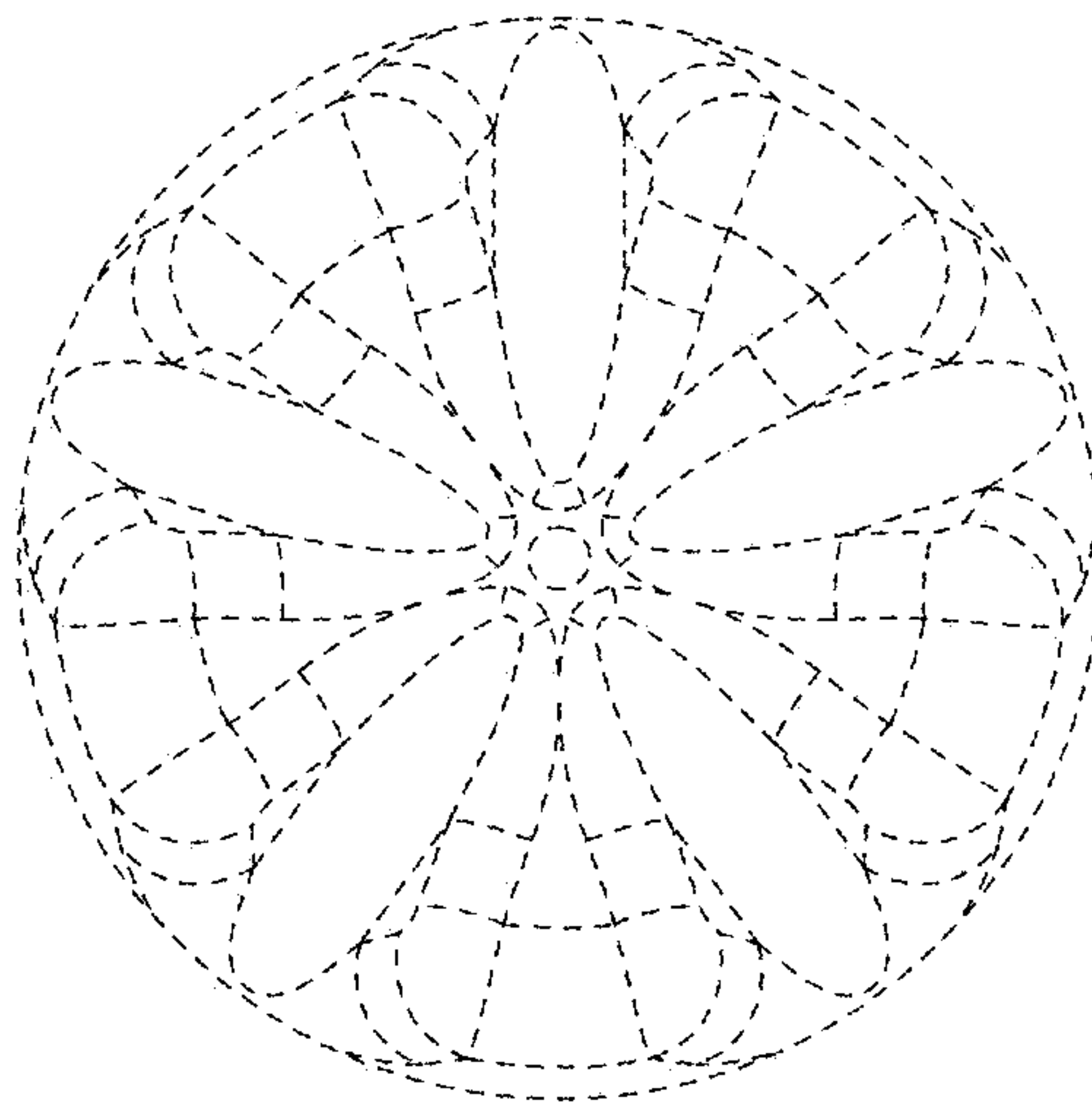

FIG. 21



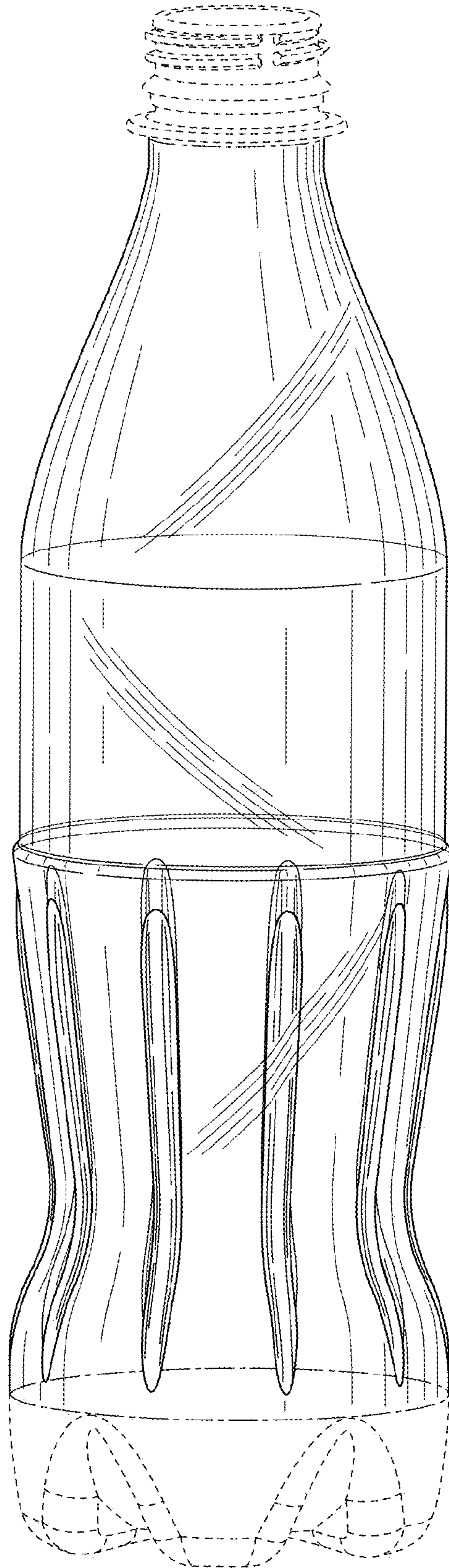

FIG. 22

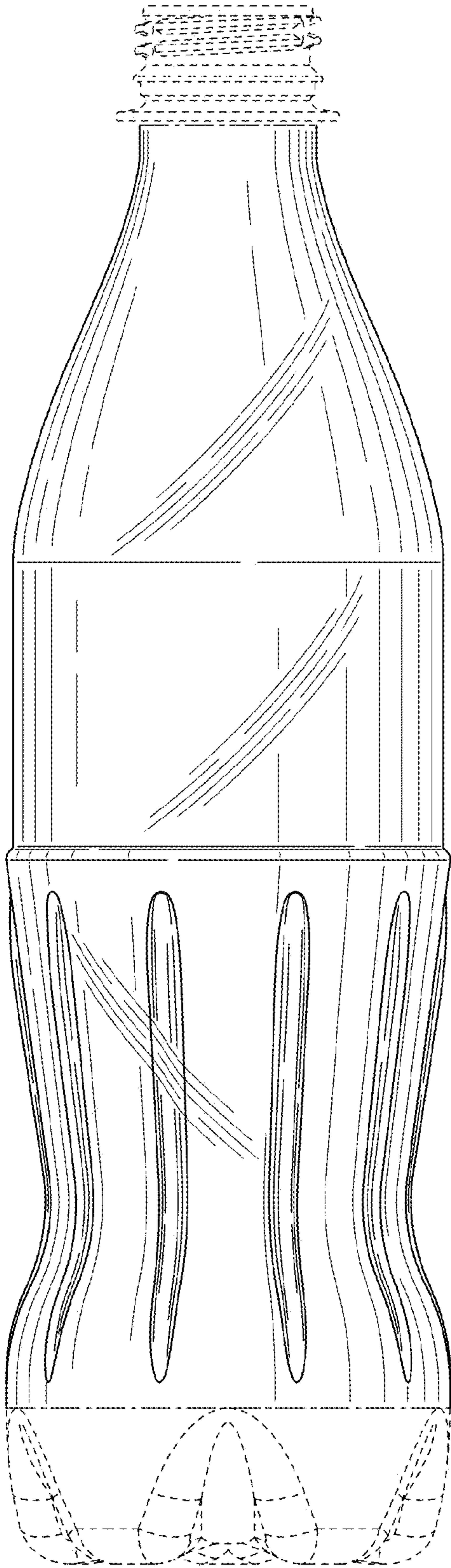

FIG. 23

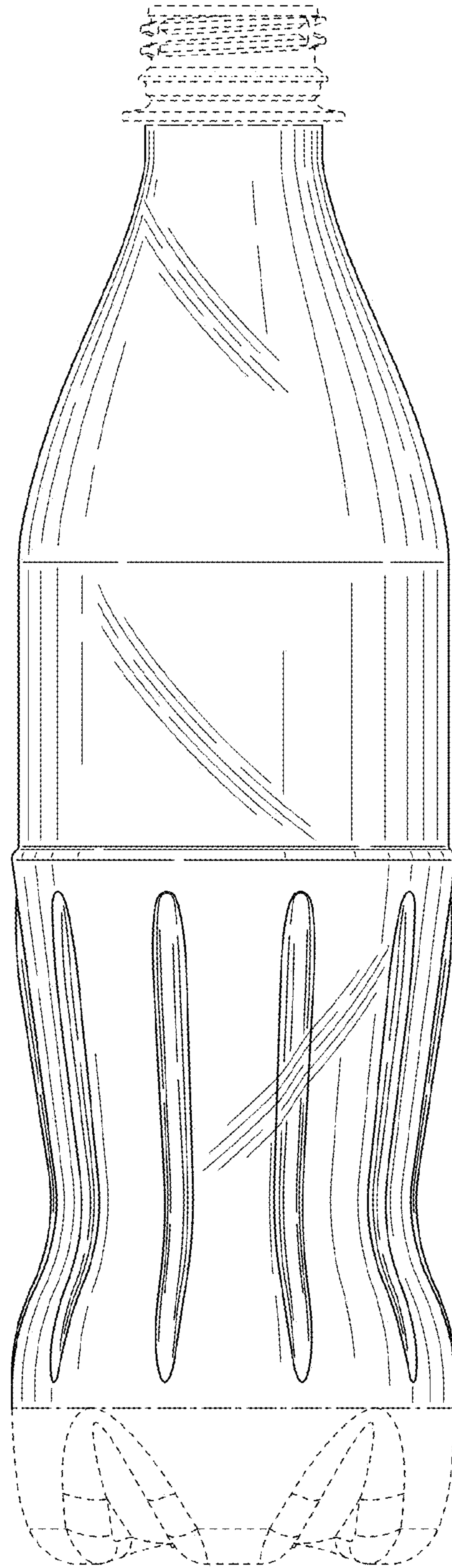

FIG. 24

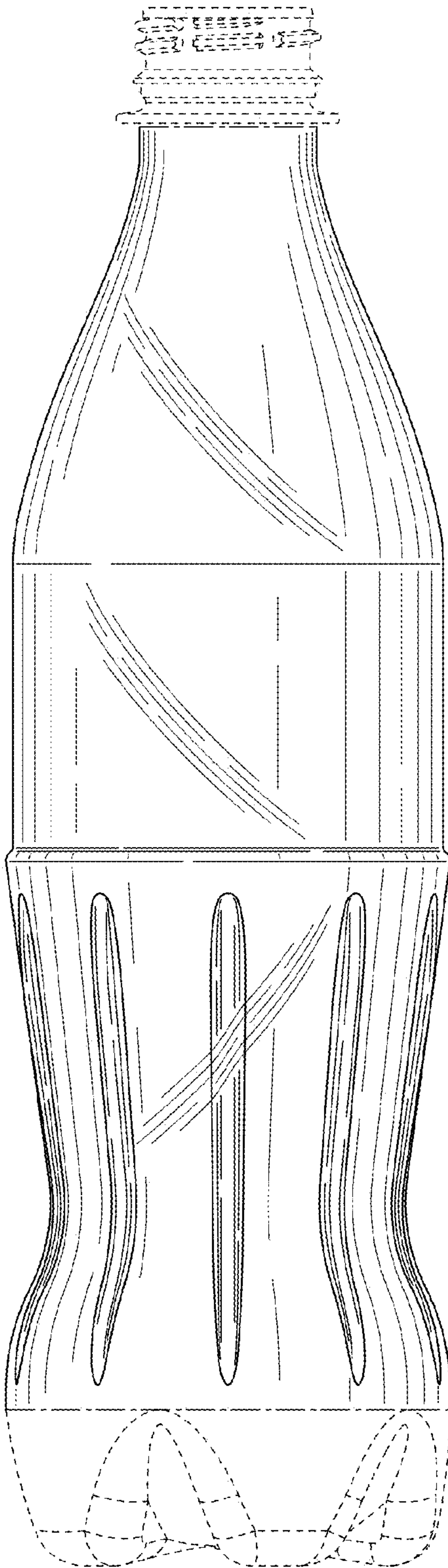

FIG. 25

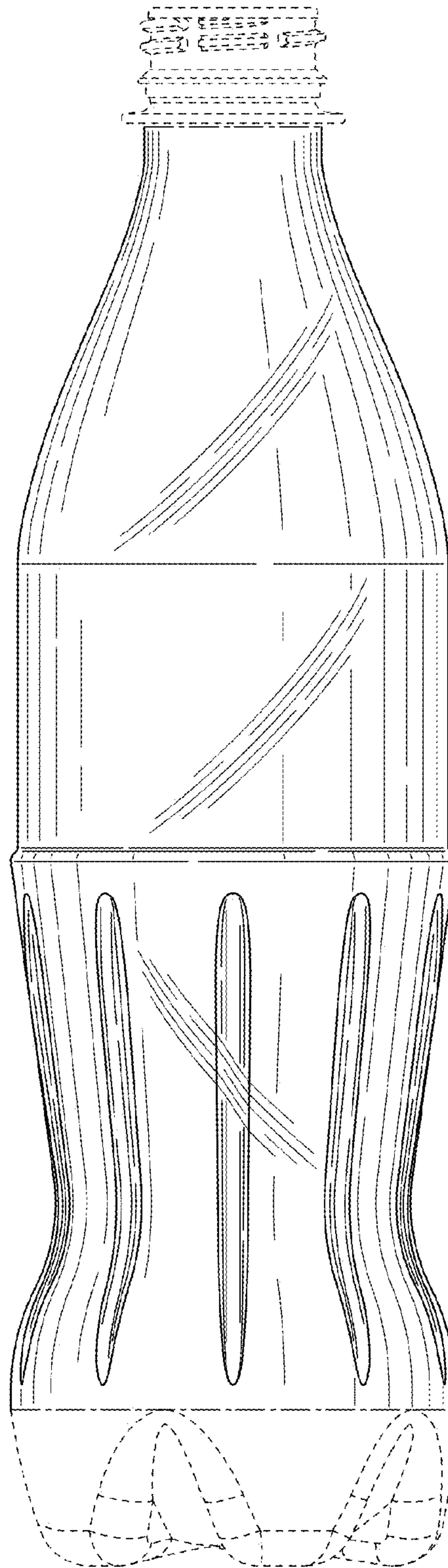

FIG. 26



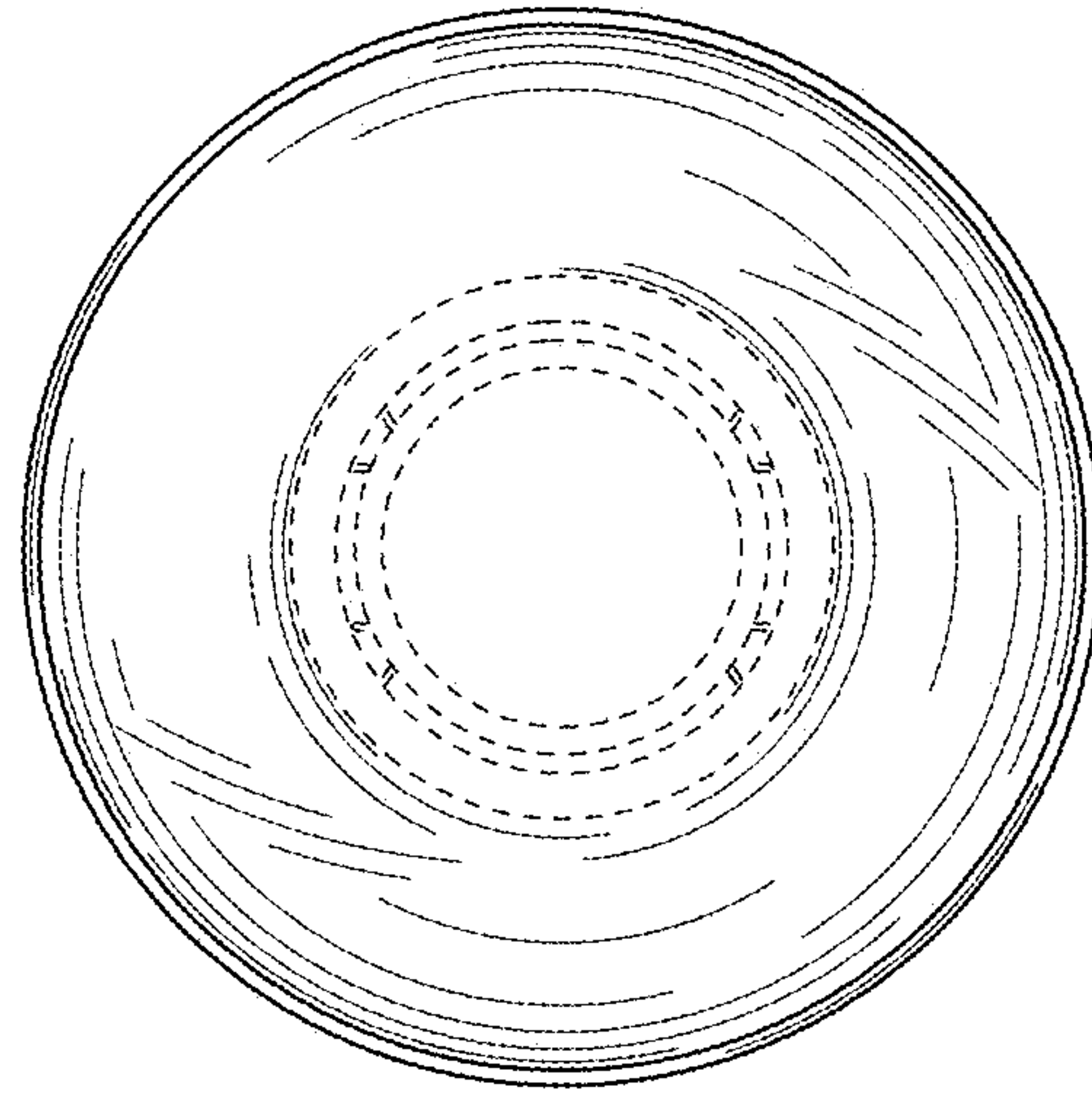

FIG. 27

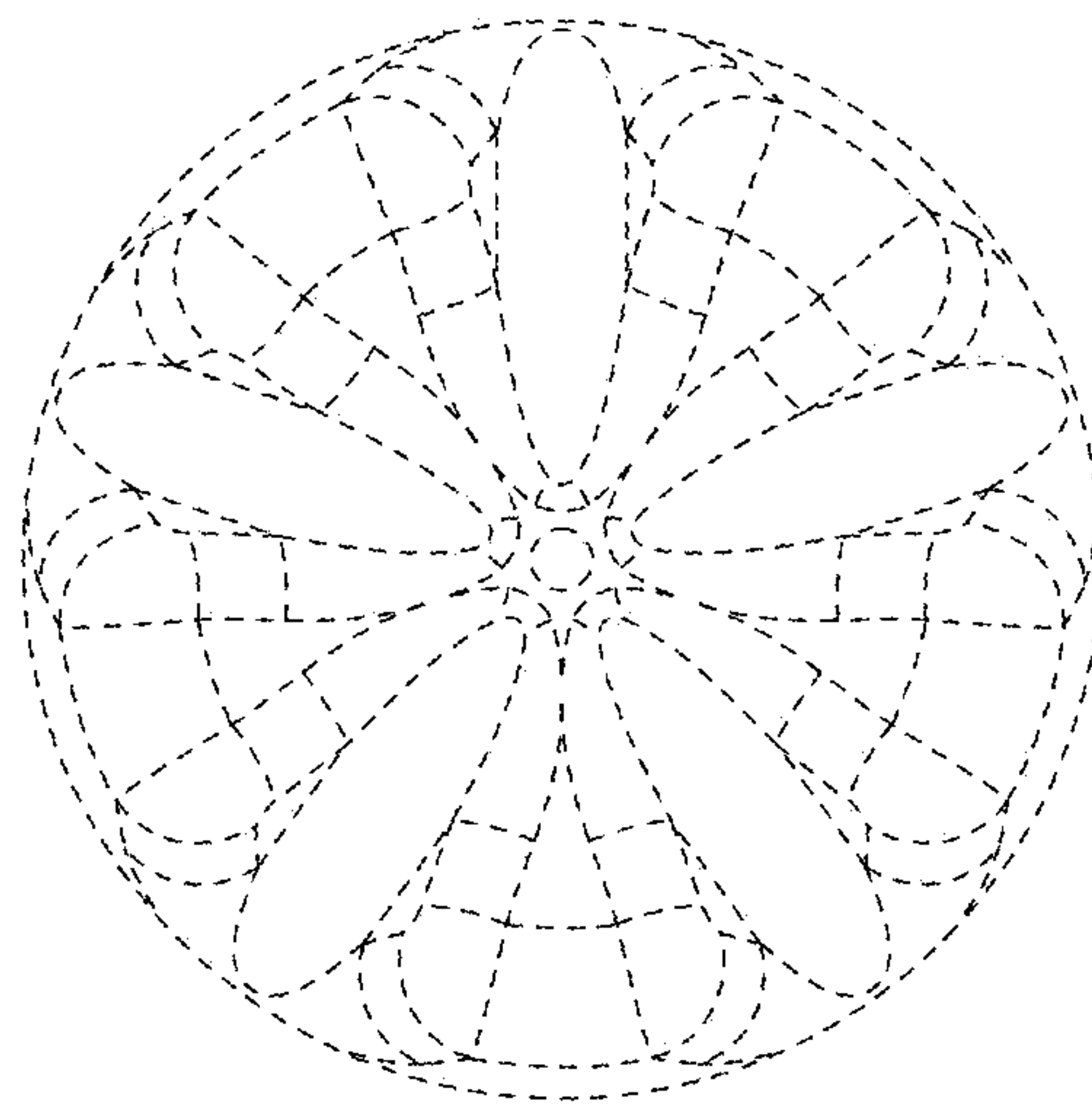

FIG. 28

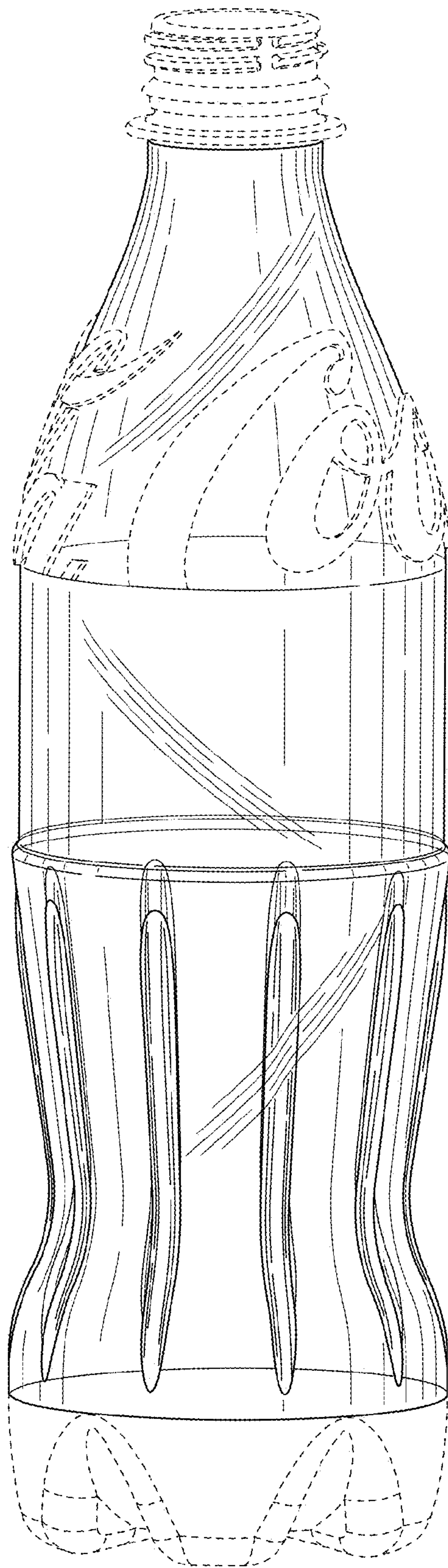

FIG. 29

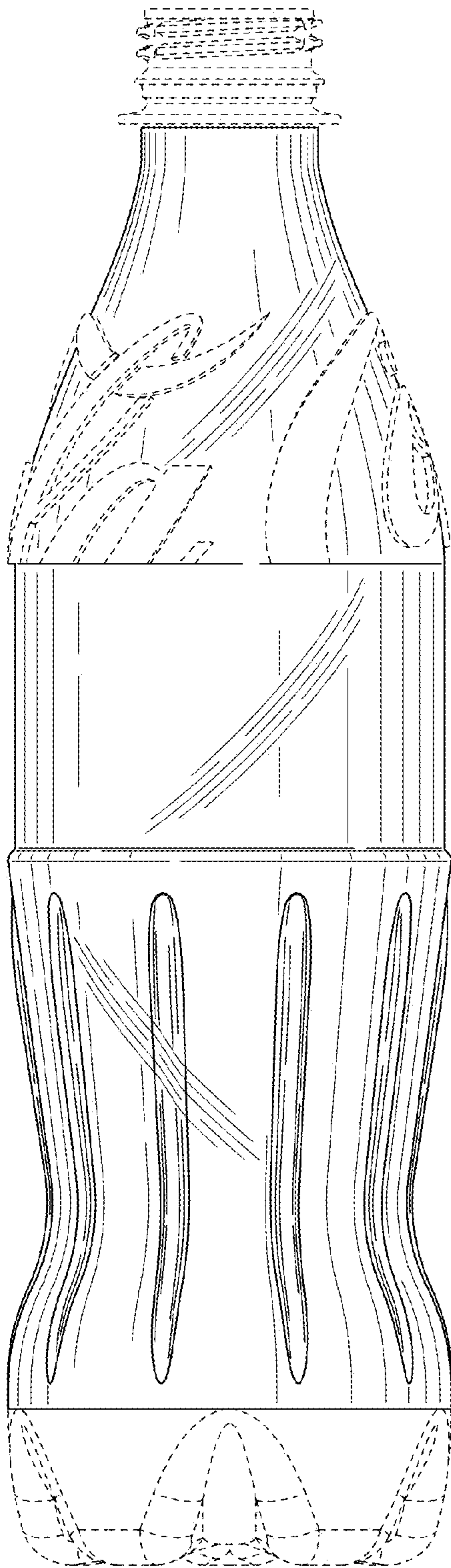

FIG. 30

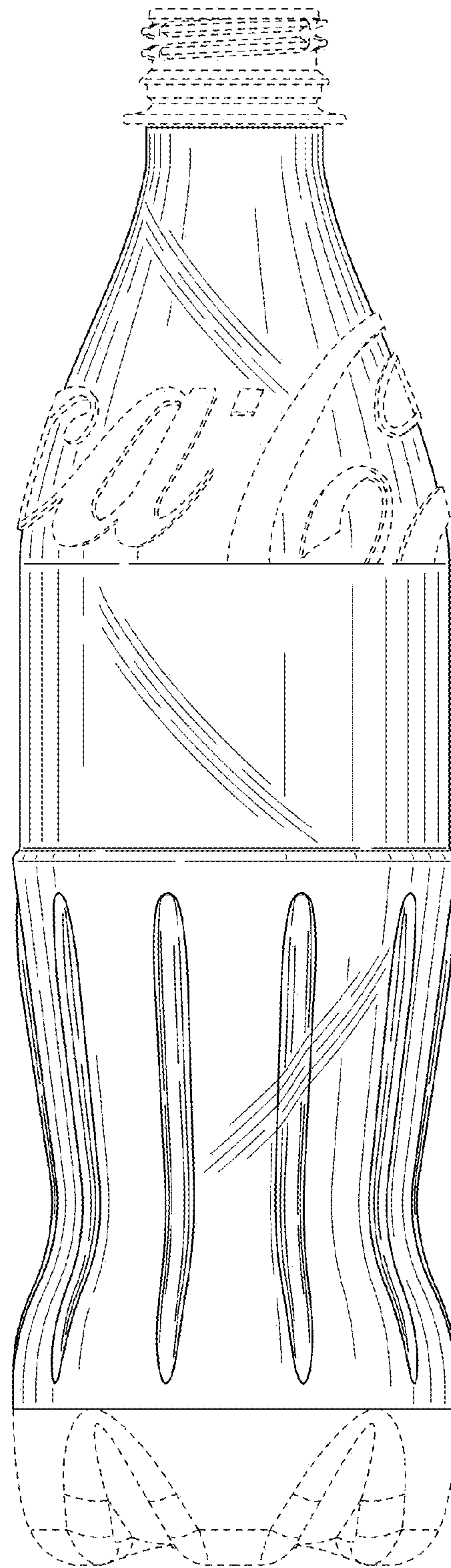

FIG. 31



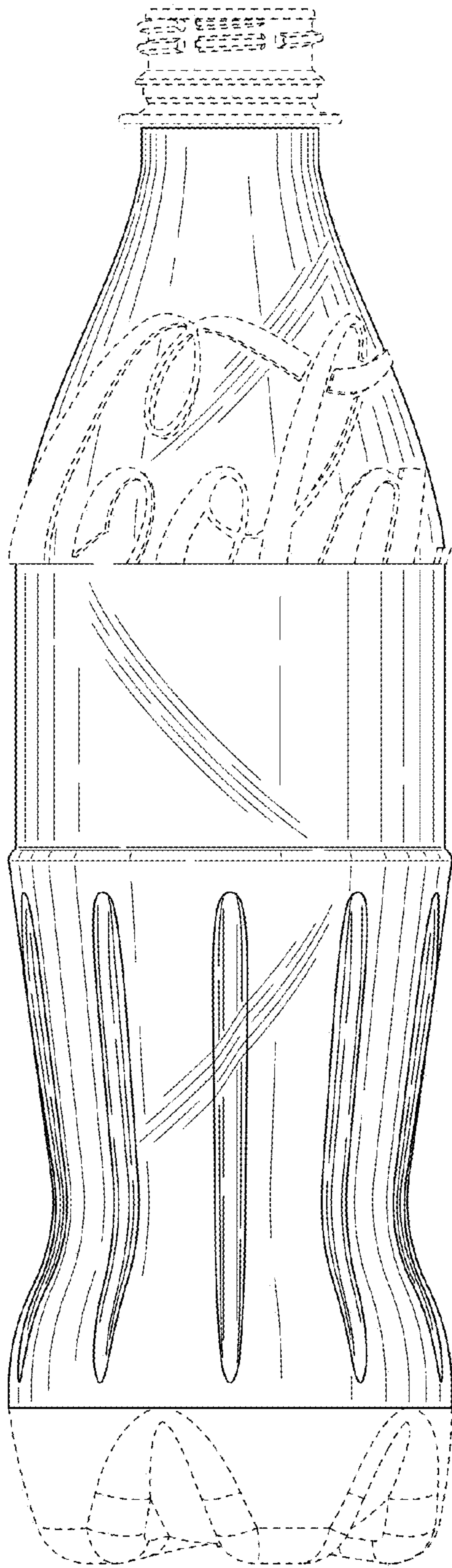

FIG. 32

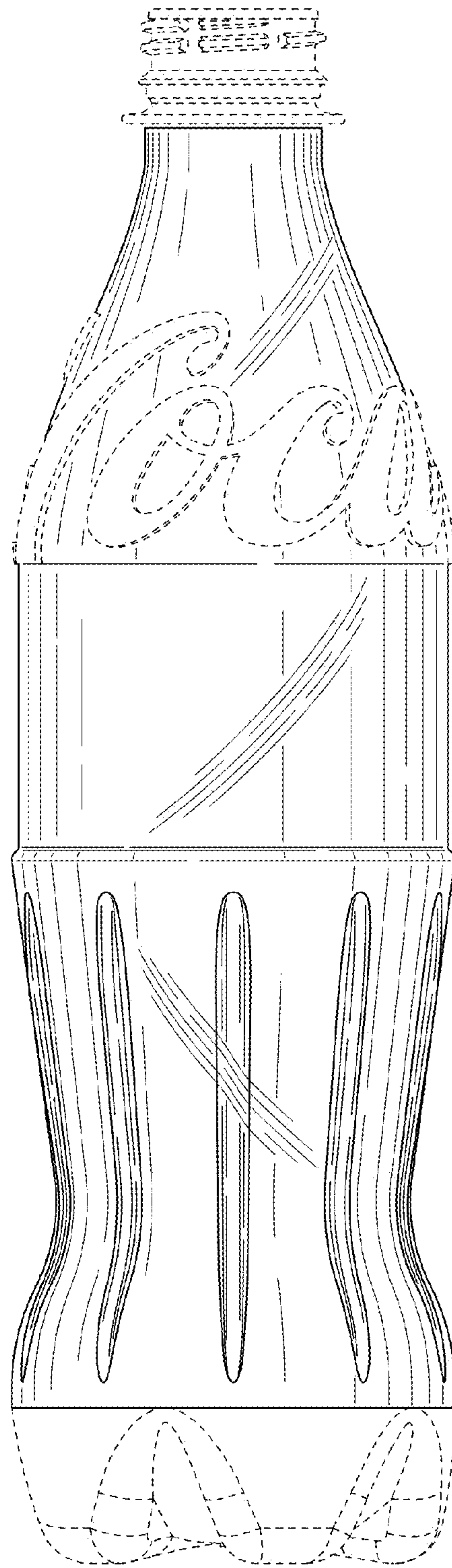

FIG. 33

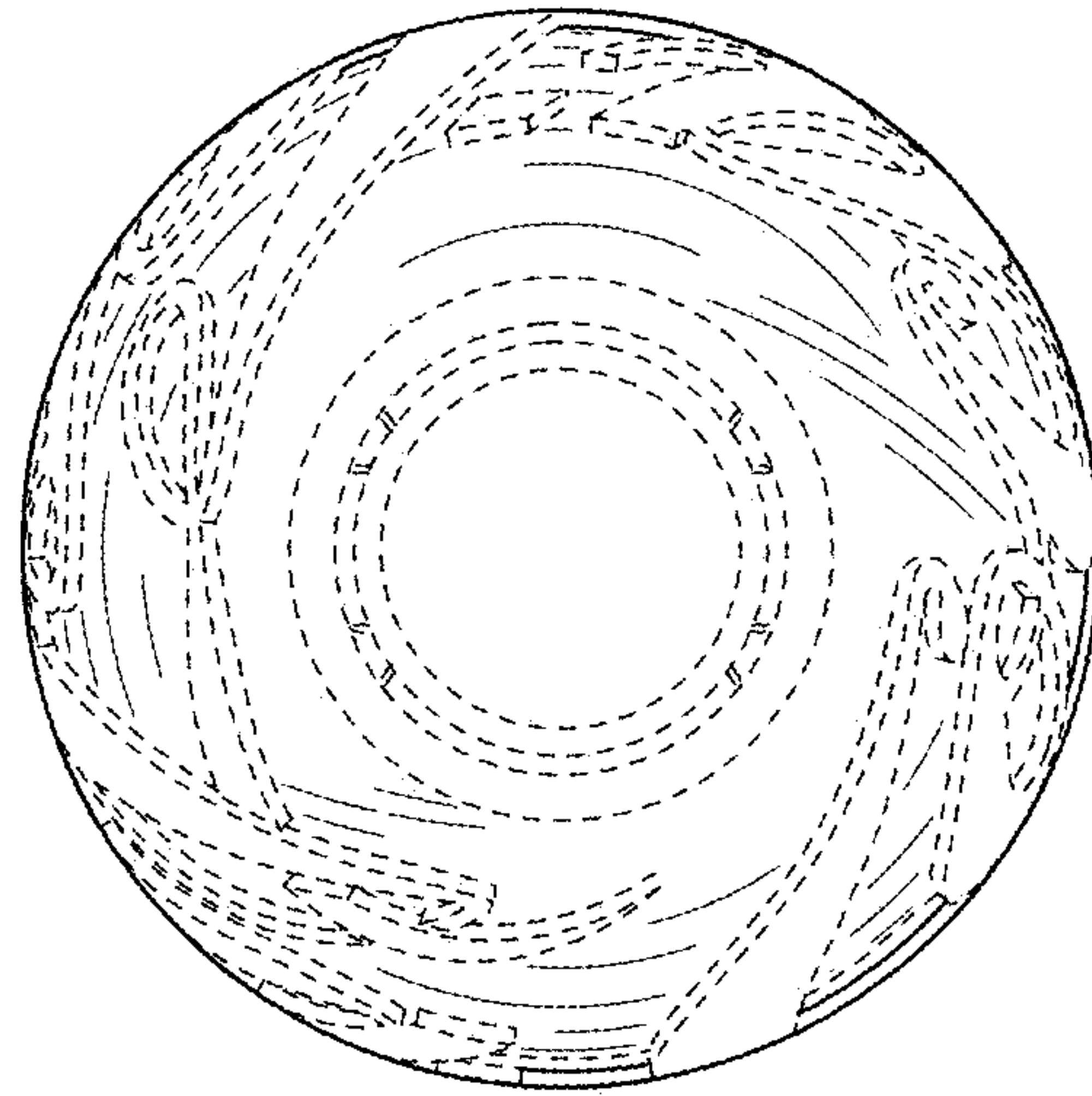

FIG. 34

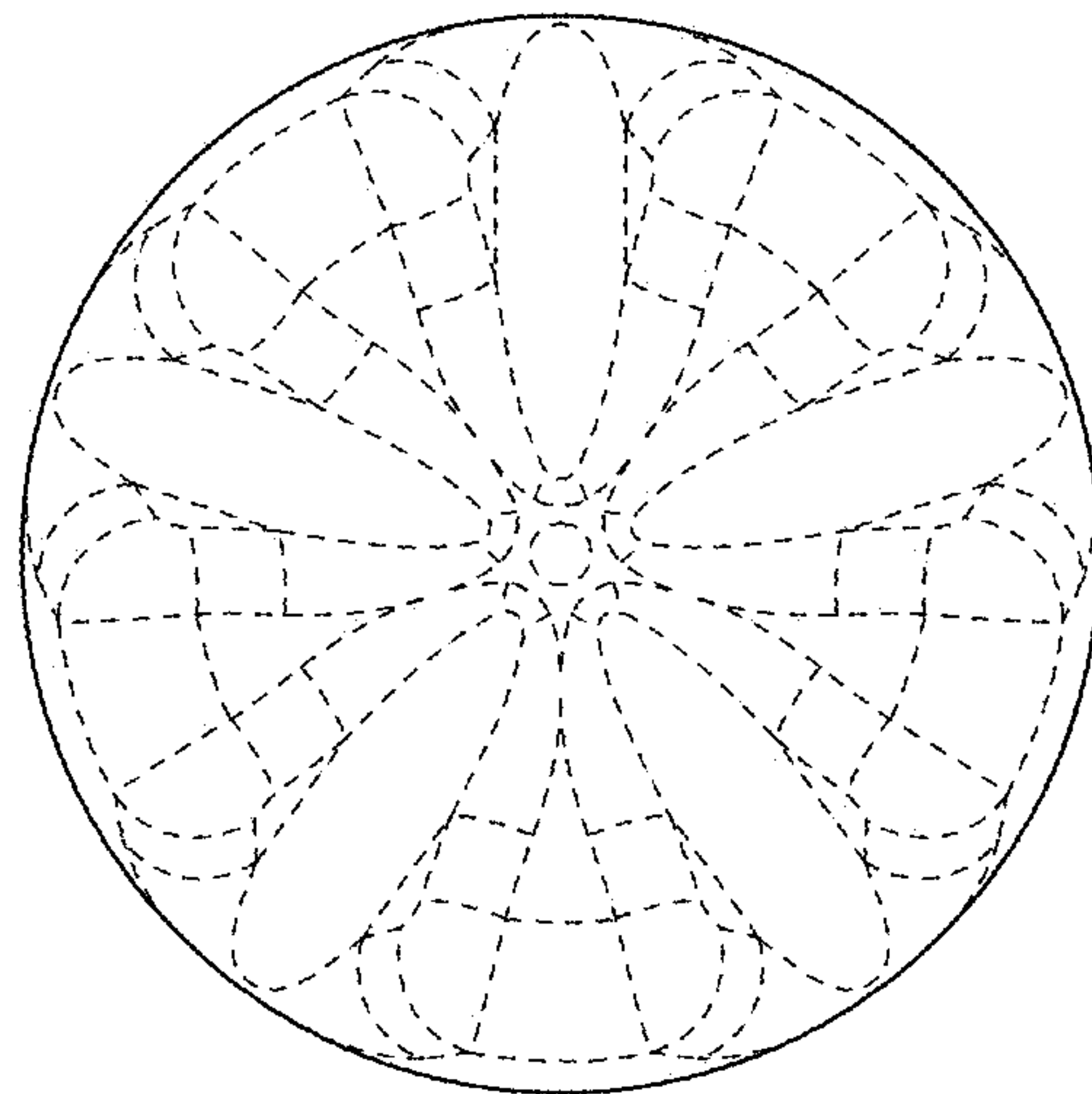

FIG. 35

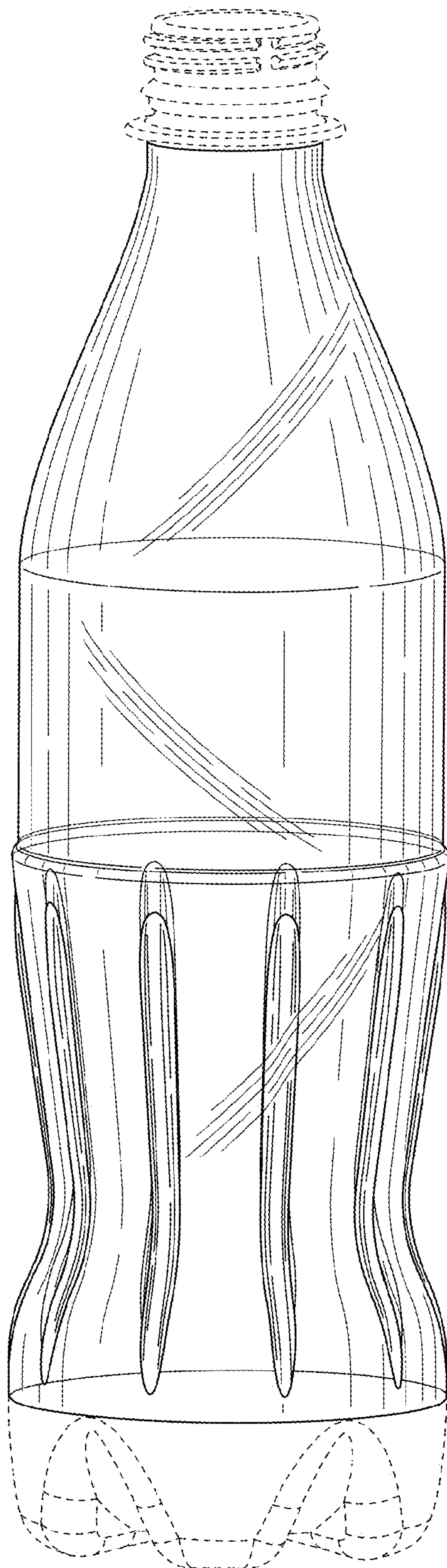

FIG. 36



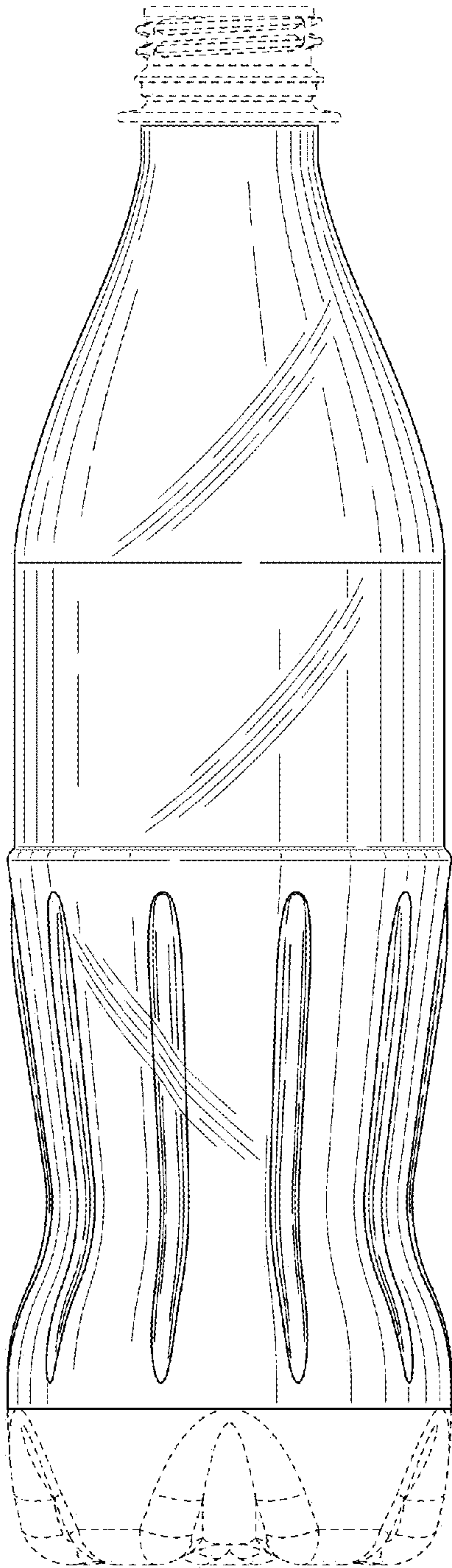

FIG. 37

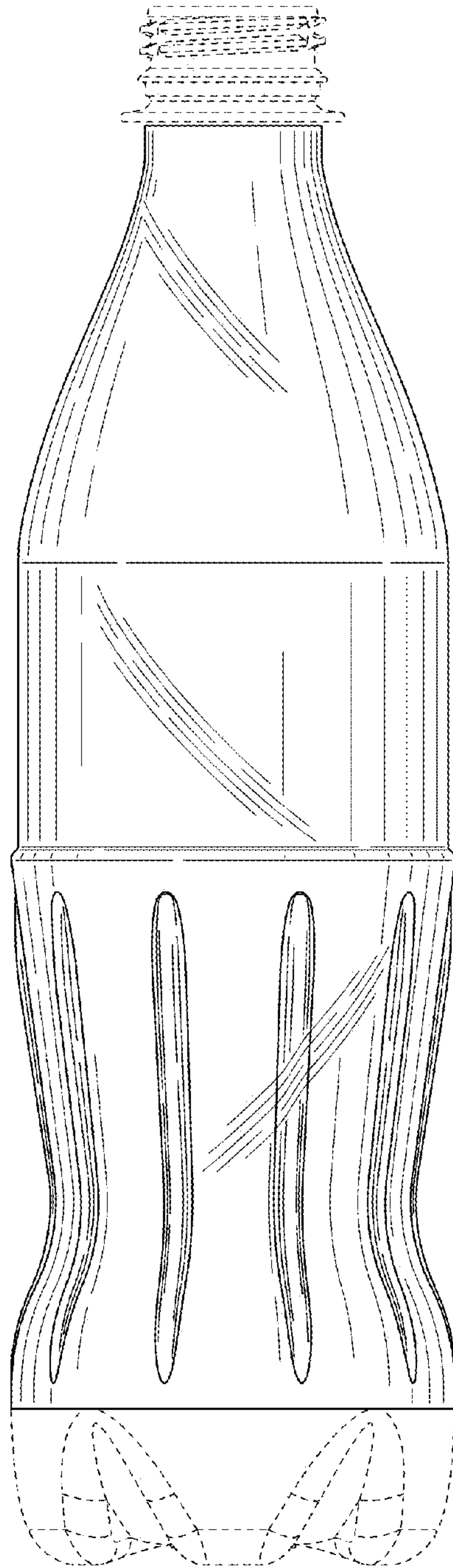

FIG. 38



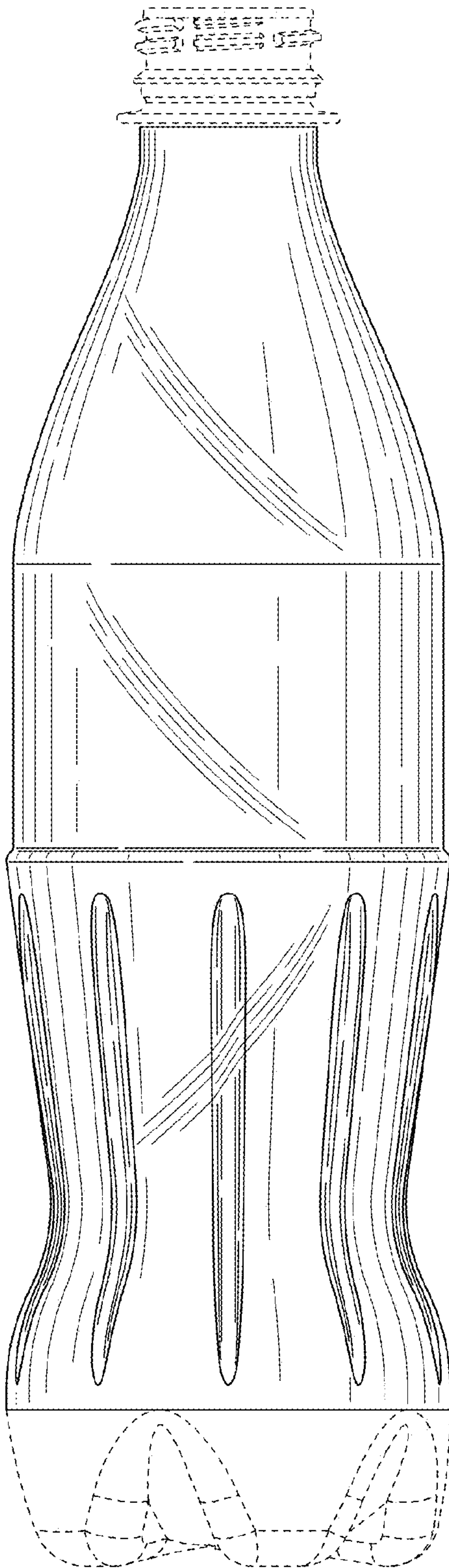

FIG. 39

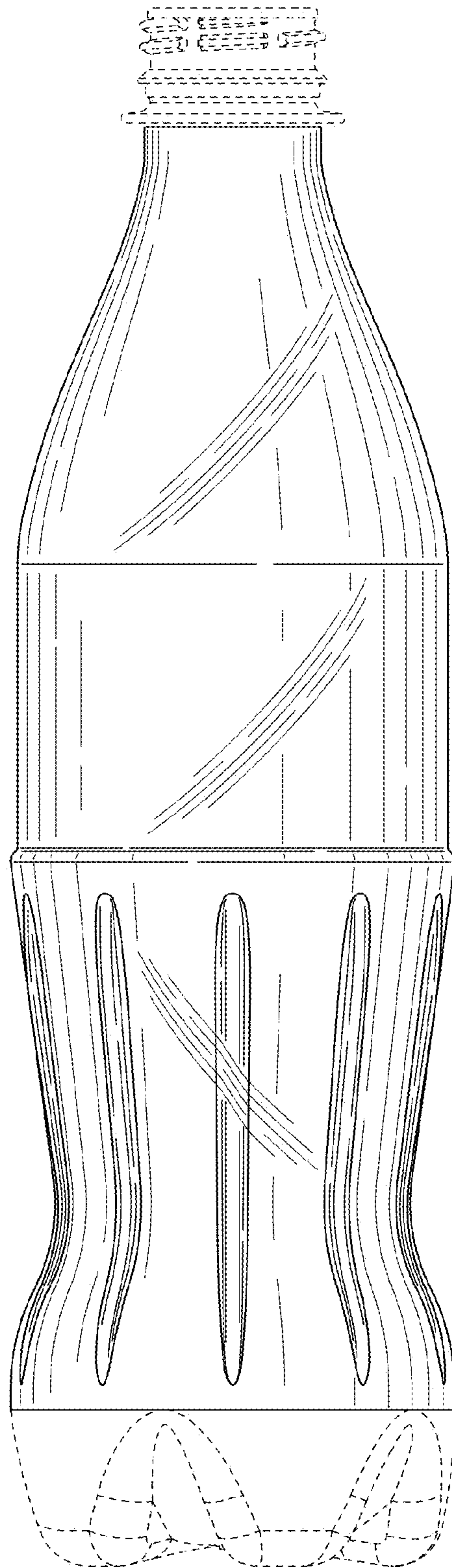

FIG. 40

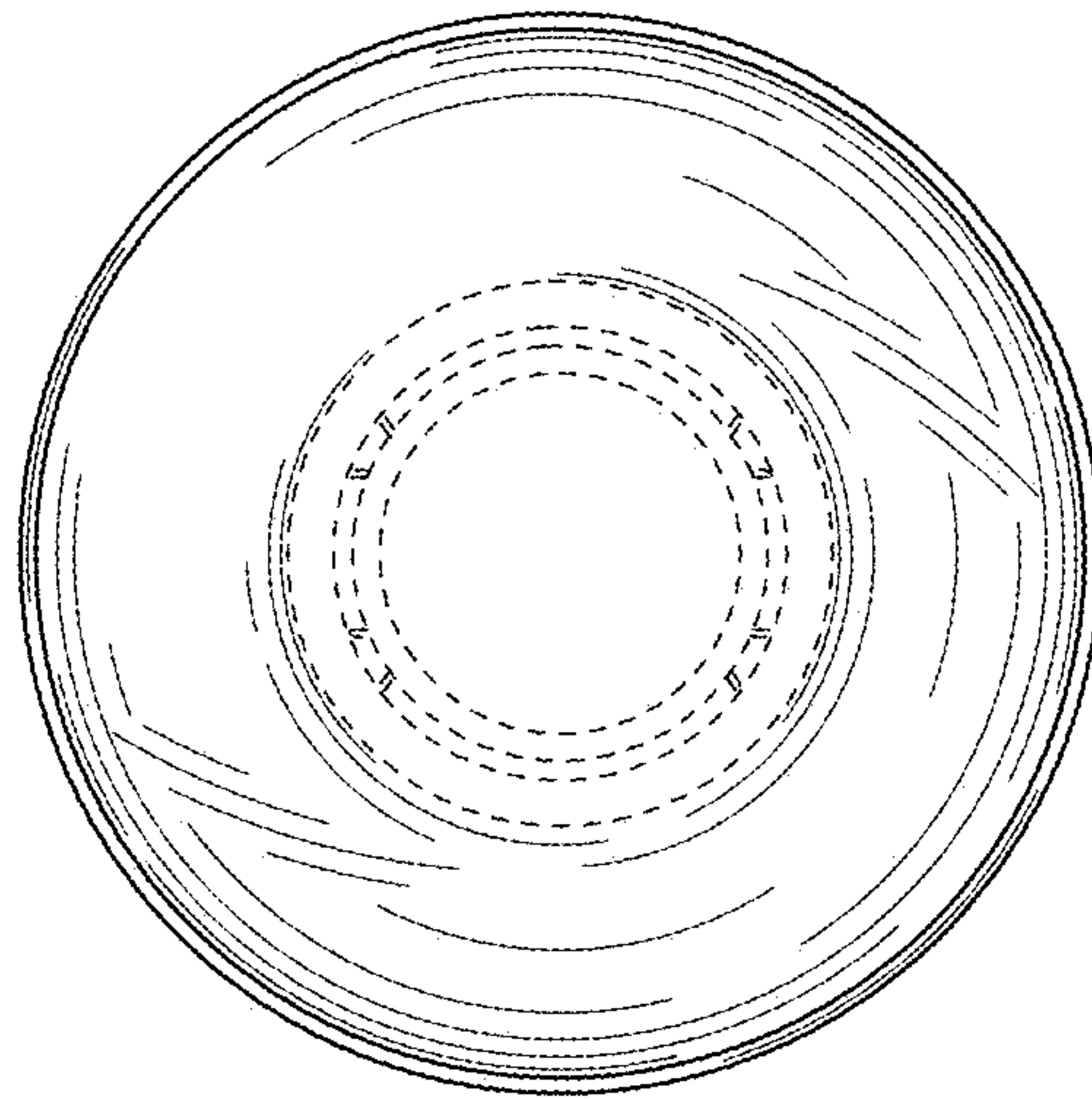

FIG. 41

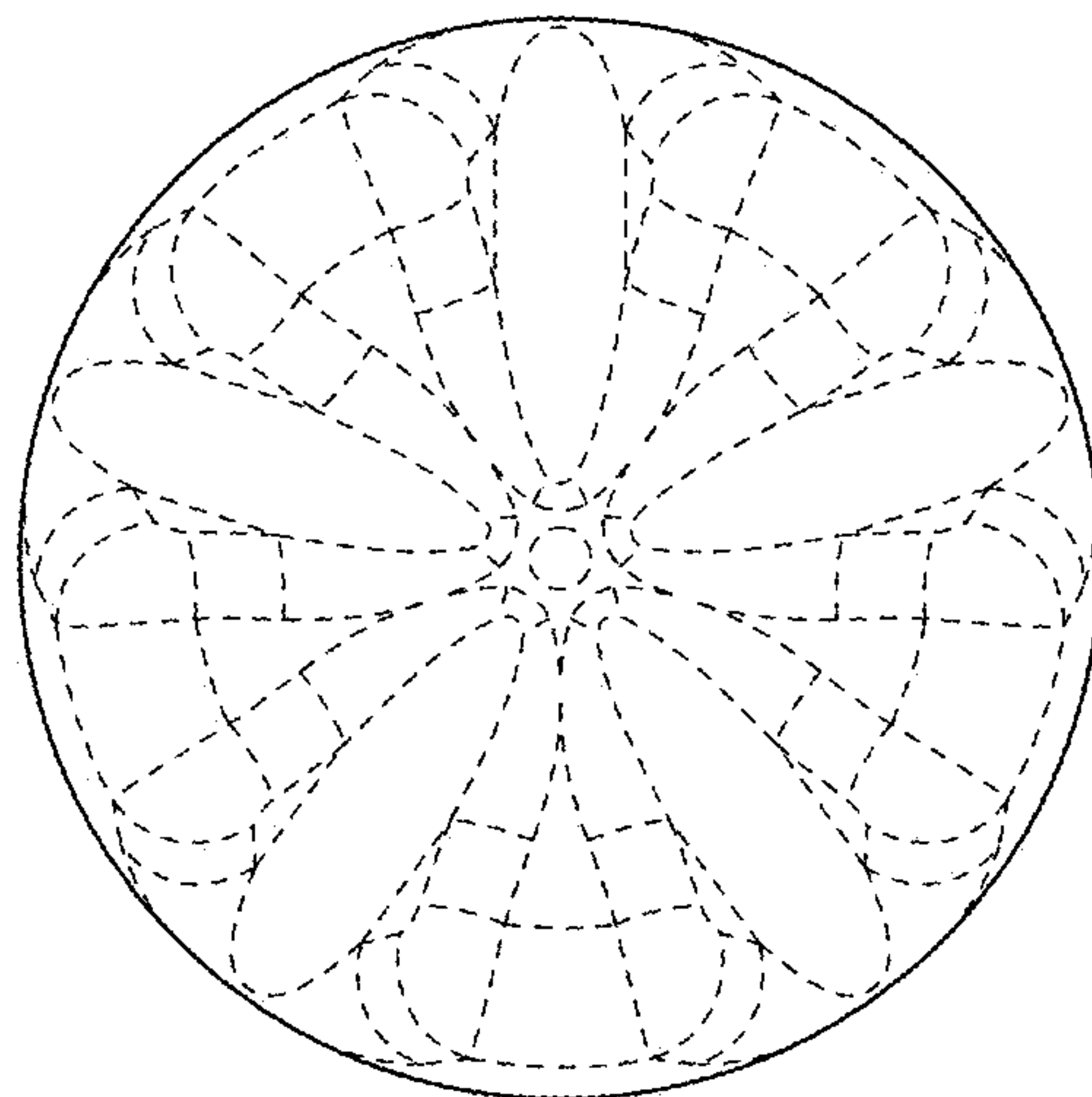

FIG. 42