



US00D756760S

(12) **United States Design Patent**
Fay, II

(10) **Patent No.:** **US D756,760 S**
(45) **Date of Patent:** **** May 24, 2016**

- (54) **KNIFE FASTENER**
- (71) Applicant: **CNH Industrial America LLC**, New Holland, PA (US)
- (72) Inventor: **Jeffrey B. Fay, II**, Lititz, PA (US)
- (73) Assignee: **CNH Industrial America LLC**, New Holland, PA (US)
- (**) Term: **14 Years**
- (21) Appl. No.: **29/489,093**
- (22) Filed: **Apr. 25, 2014**
- (51) **LOC (10) Cl.** **08-08**
- (52) **U.S. Cl.**
USPC **D8/382**; D15/17
- (58) **Field of Classification Search**
USPC D8/349, 382, 394, 396, 397, 399, 499;
D15/17
CPC . A01D 34/733; A01D 34/736; A01D 34/866;
A01D 34/82; F16B 19/02; F16B 37/062
See application file for complete search history.

- (56) **References Cited**
U.S. PATENT DOCUMENTS
- 1,785,709 A * 12/1930 Campau F16B 5/02
411/368
- 2,684,490 A * 7/1954 Wright B27F 7/02
227/97
- 3,956,803 A * 5/1976 Leitner F16B 21/02
411/349
- 5,142,834 A * 9/1992 Laclave B60R 13/04
24/453

- 5,975,822 A * 11/1999 Ruff B64D 11/0696
292/218
- D548,571 S * 8/2007 Bigelow D8/349
- 7,703,267 B2 * 4/2010 Tapper A01D 34/733
56/255
- D743,246 S * 11/2015 Levey D8/397
- 2010/0326034 A1 * 12/2010 Gilpatrick A01D 34/733
56/17.5
- 2013/0336784 A1 * 12/2013 Sankolli F16B 13/0858
415/220
- 2014/0126952 A1 * 5/2014 Fay, II A01D 34/733
403/161
- 2015/0305235 A1 * 10/2015 Fay, II A01D 34/733
56/295

* cited by examiner

Primary Examiner — Sheryl Lane
Assistant Examiner — Ieisha Price
(74) *Attorney, Agent, or Firm* — Patrick M. Sheldrake

(57) **CLAIM**
The ornamental design for a knife fastener, as shown and described.

DESCRIPTION

FIG. 1 is a bottom perspective view of a knife fastener showing our new design;
FIG. 2 is a top perspective view thereof;
FIG. 3 is a left side view thereof;
FIG. 4 is a right side view thereof;
FIG. 5 is a front view thereof;
FIG. 6 is a back view thereof;
FIG. 7 is a bottom view thereof; and,
FIG. 8 is a top view thereof.

1 Claim, 2 Drawing Sheets

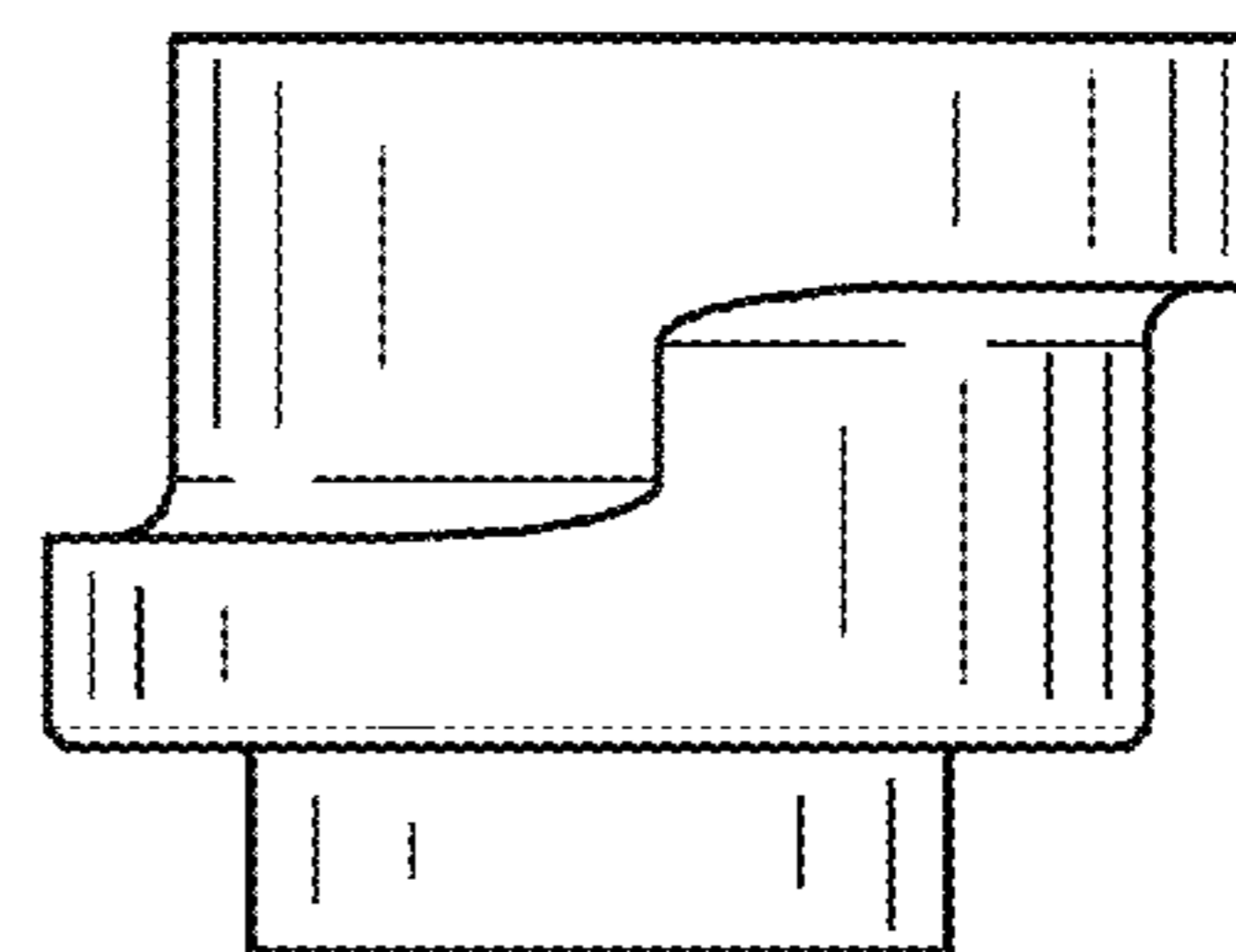
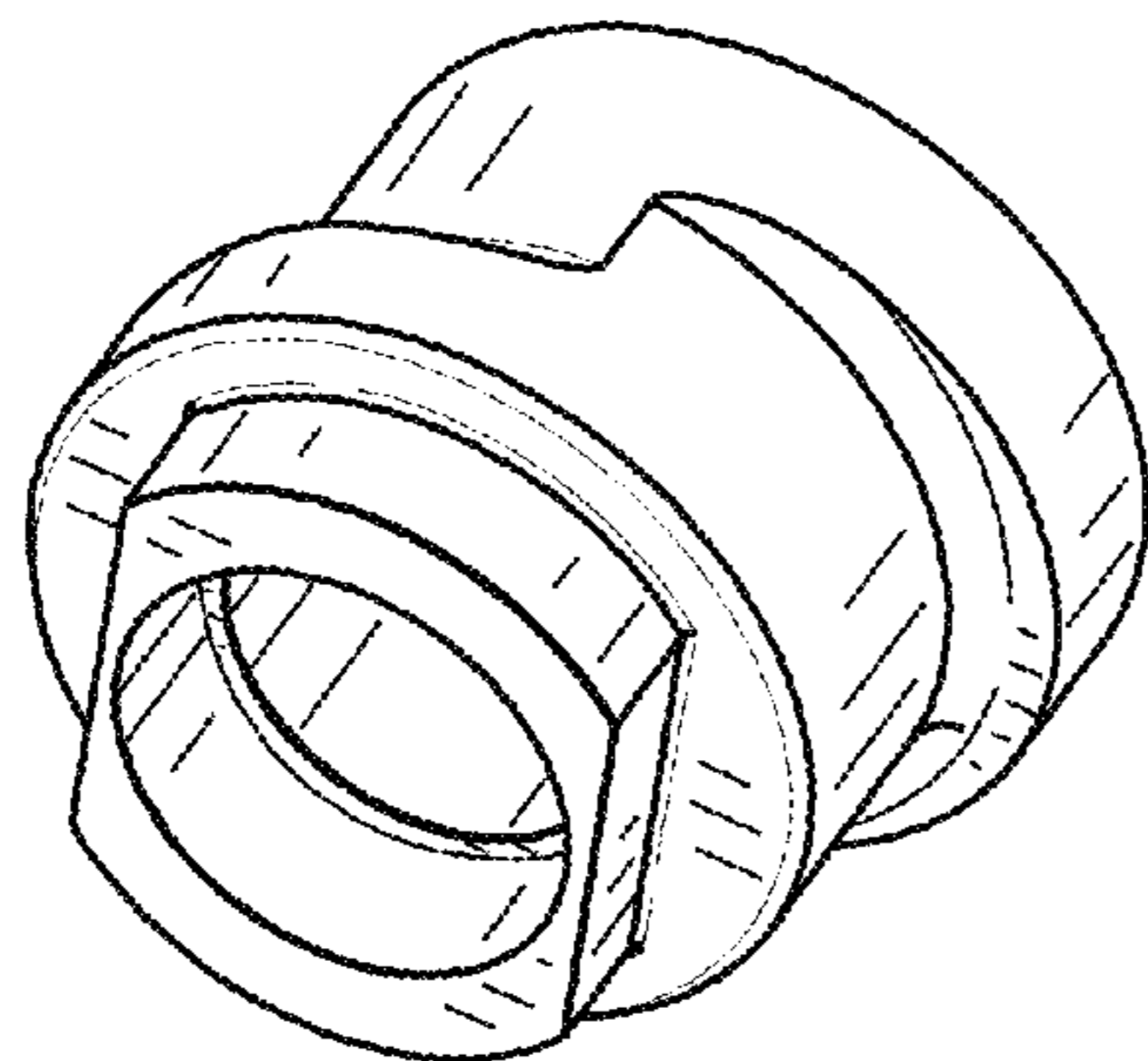

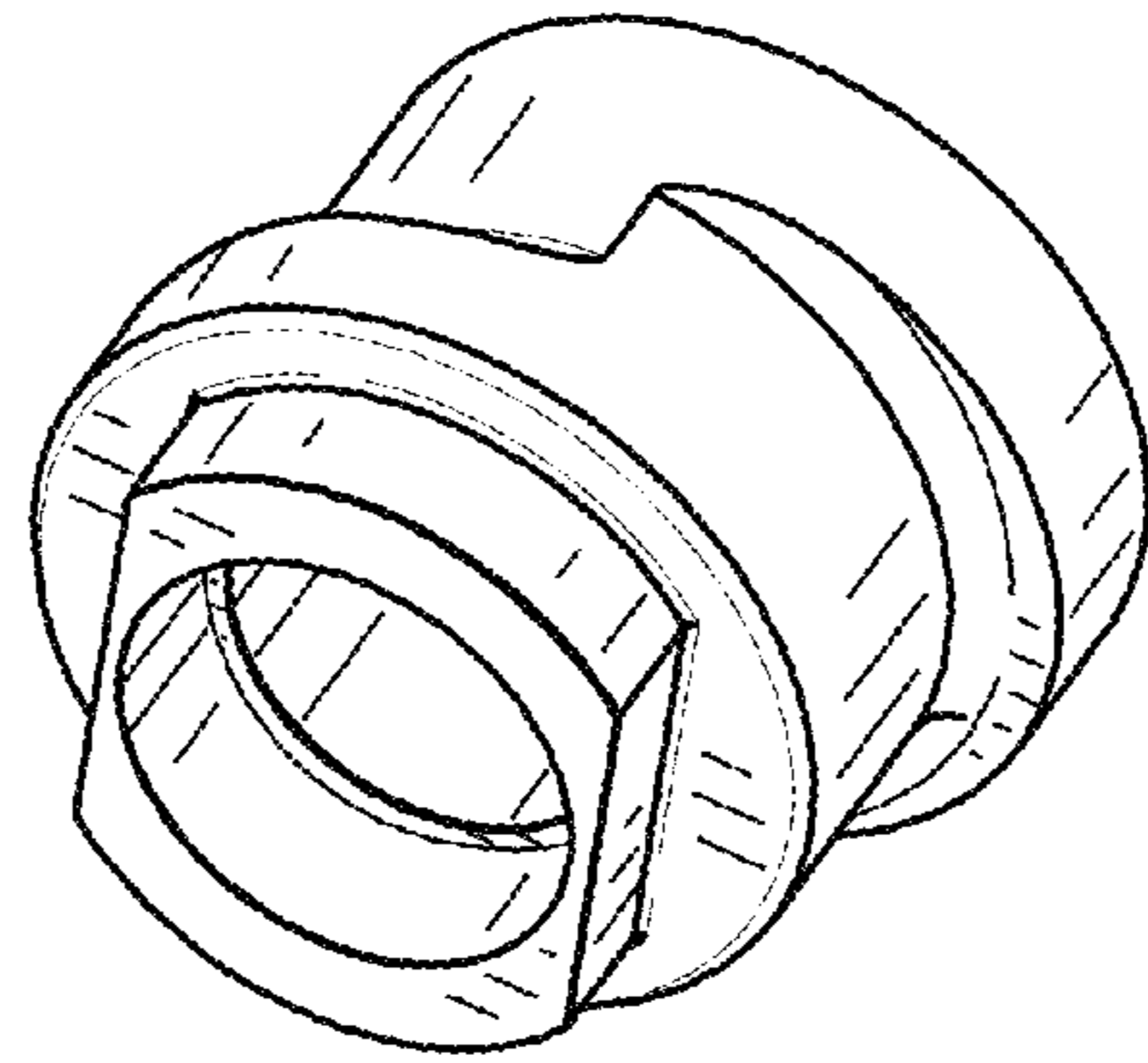

FIG. 1

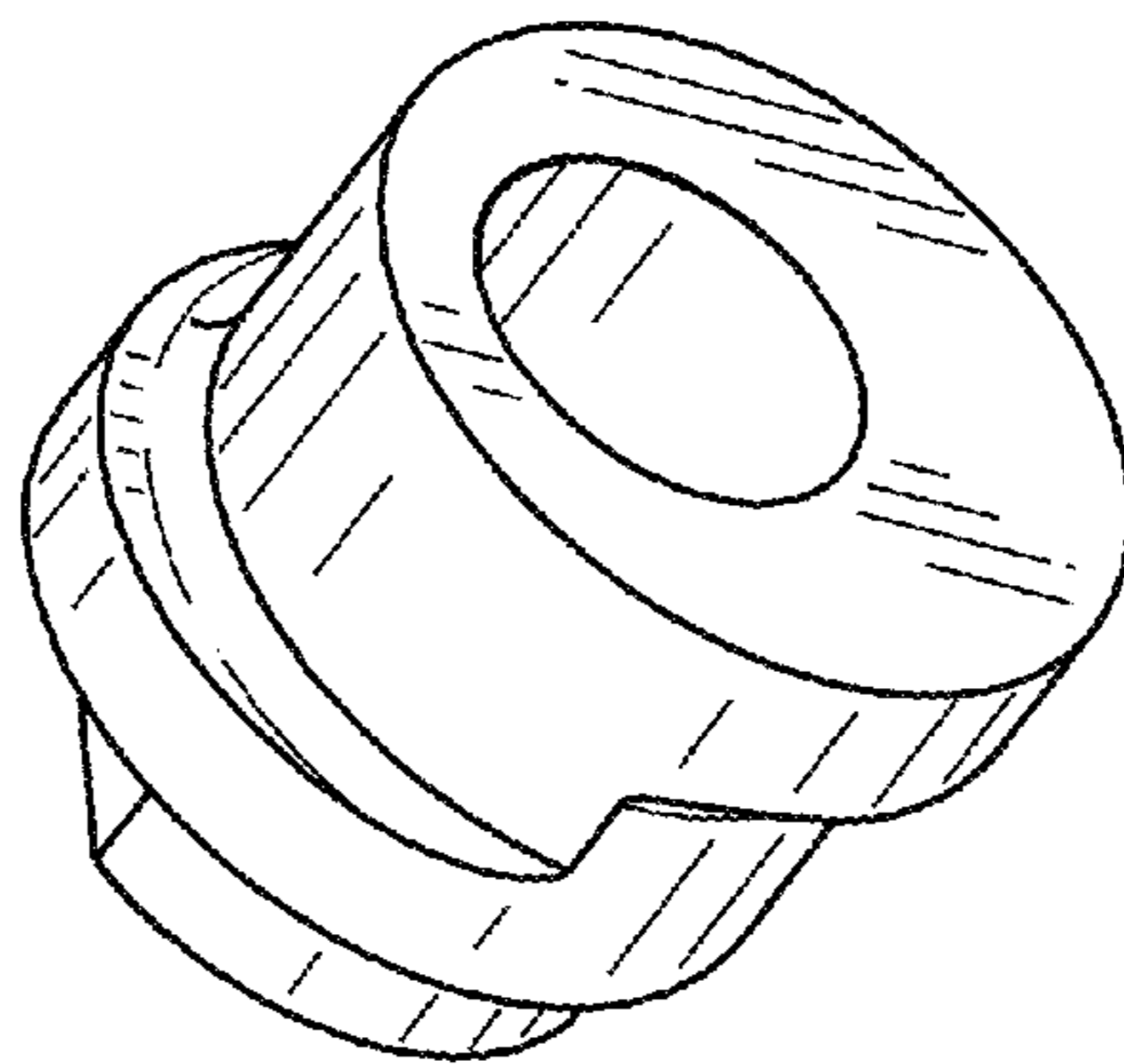

FIG. 2

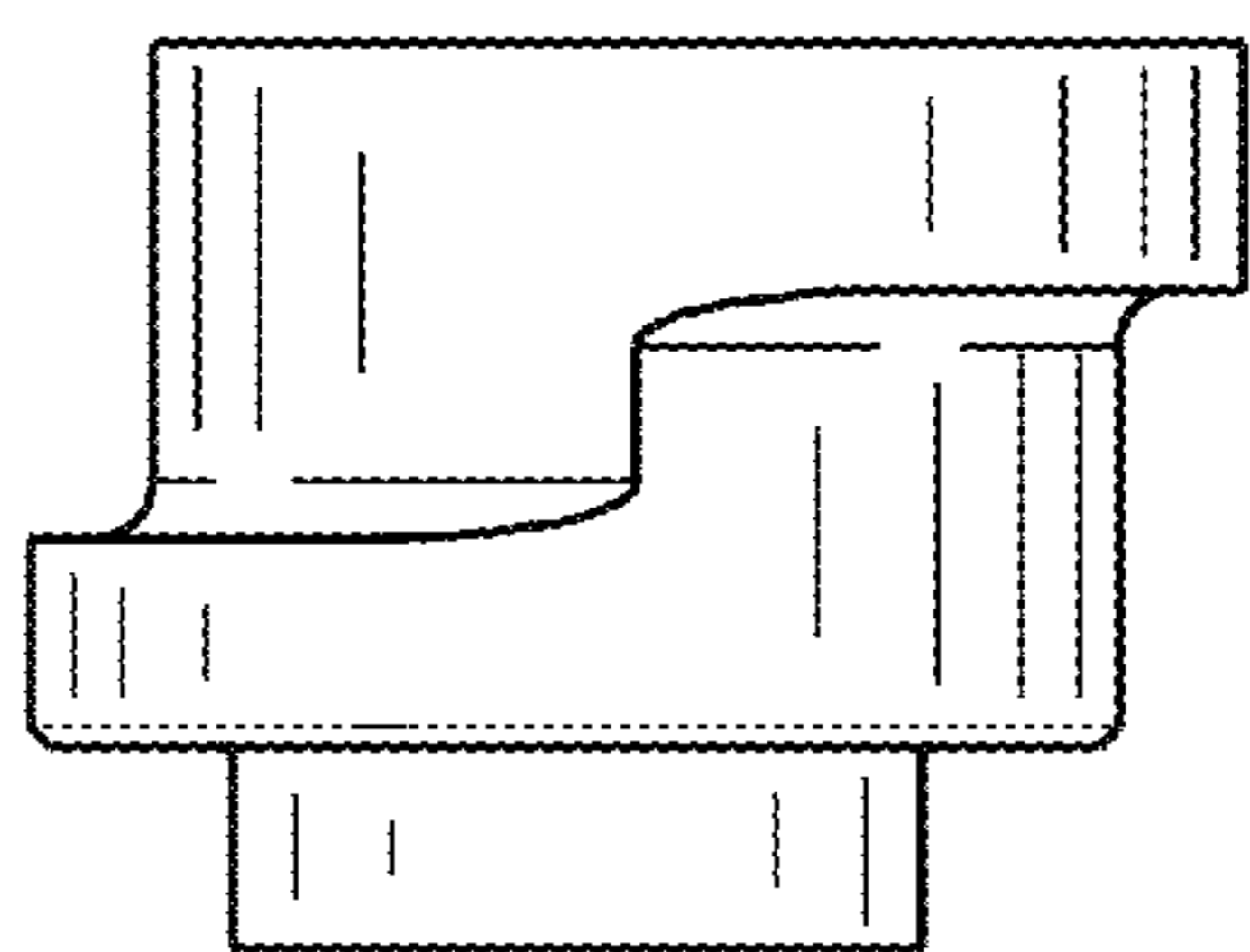

FIG. 3

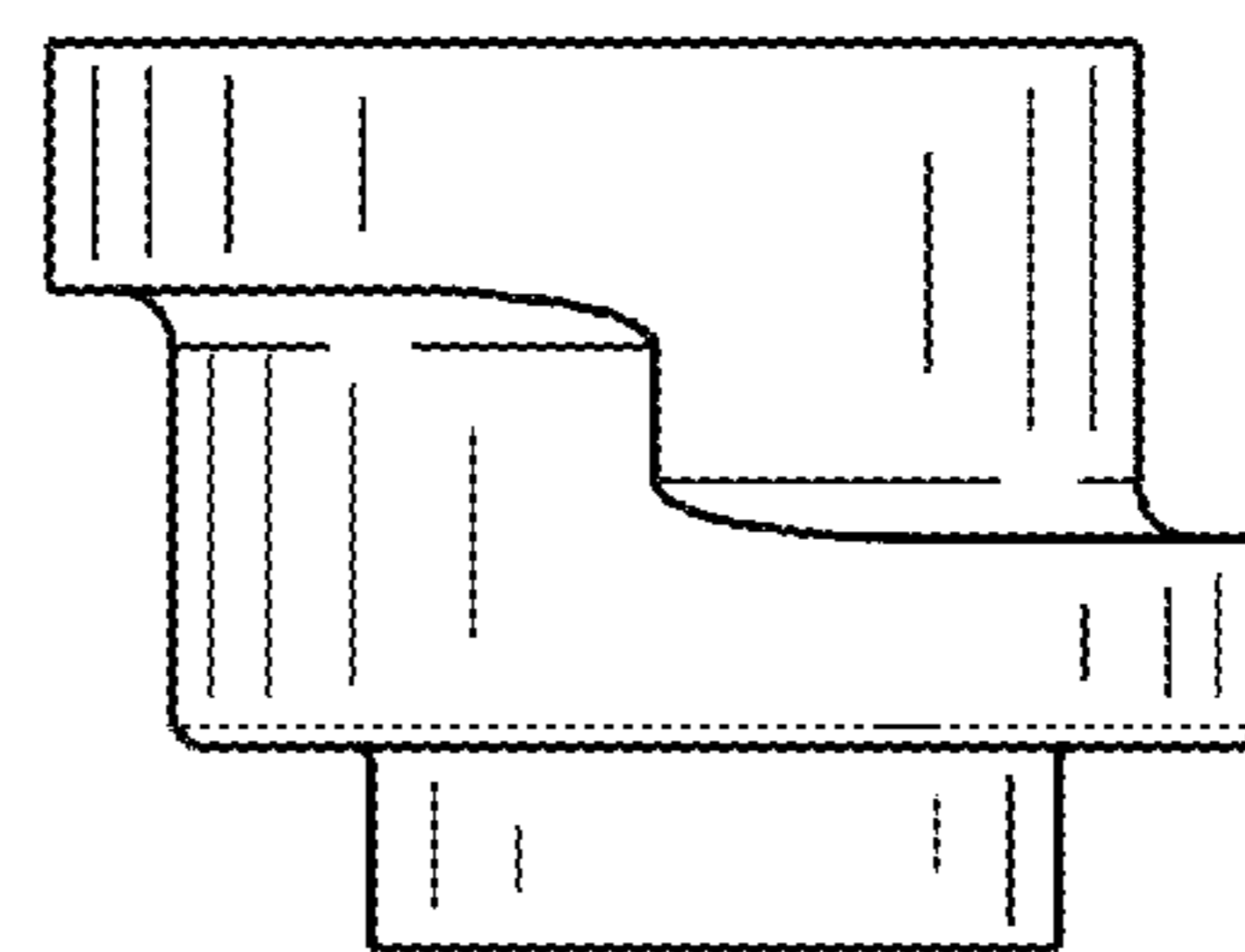

FIG. 4

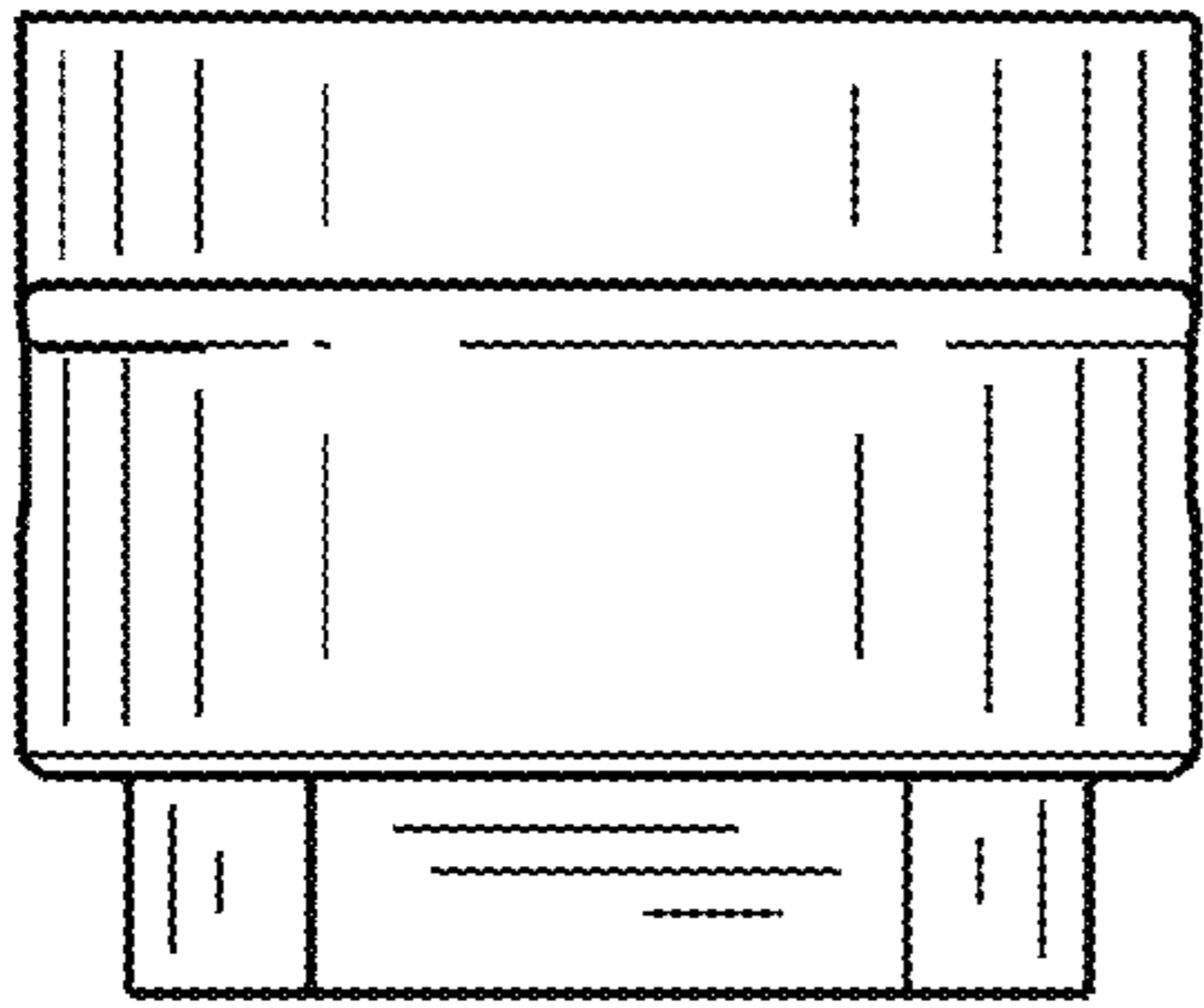

FIG. 5

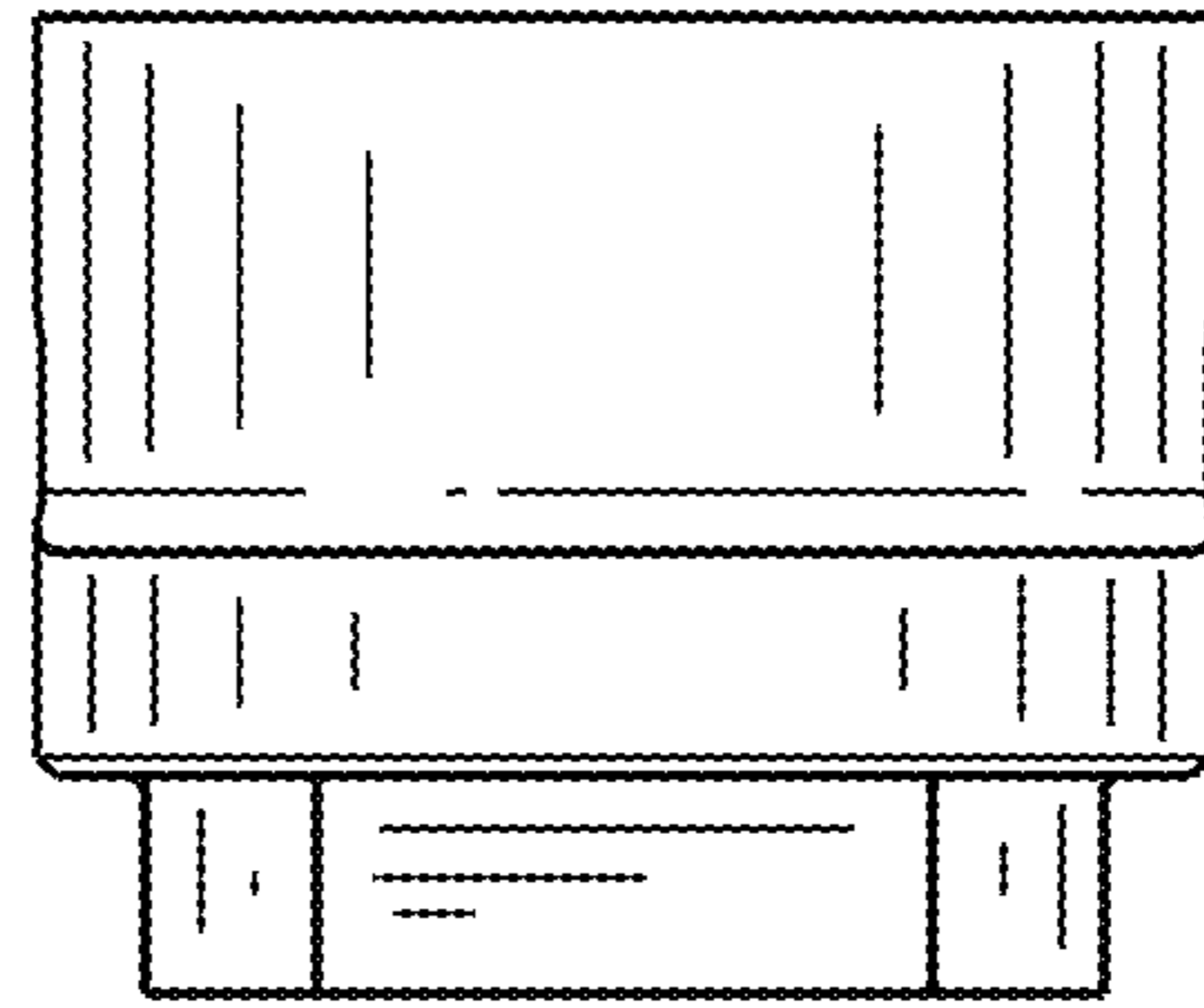

FIG. 6

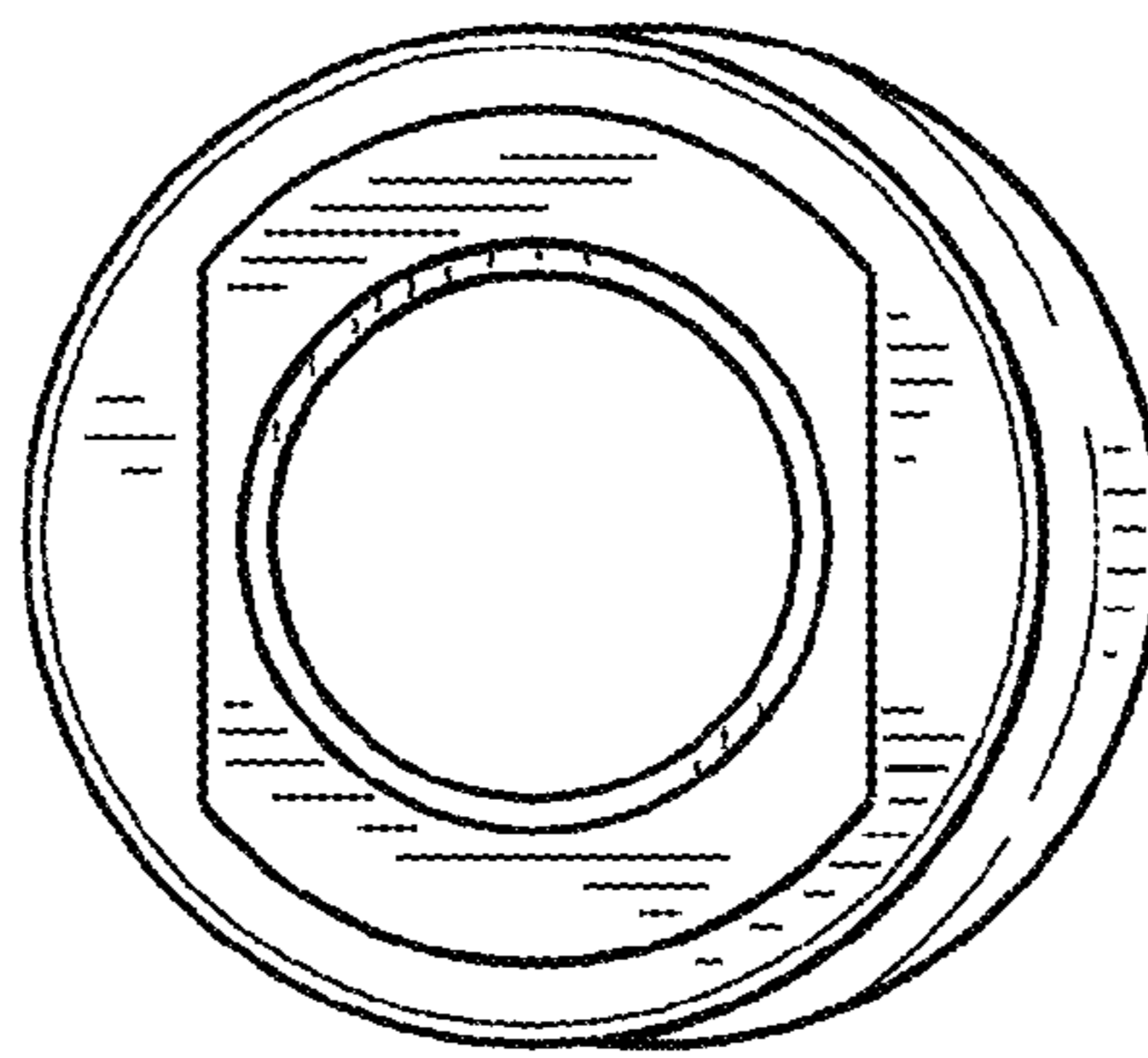

FIG. 7

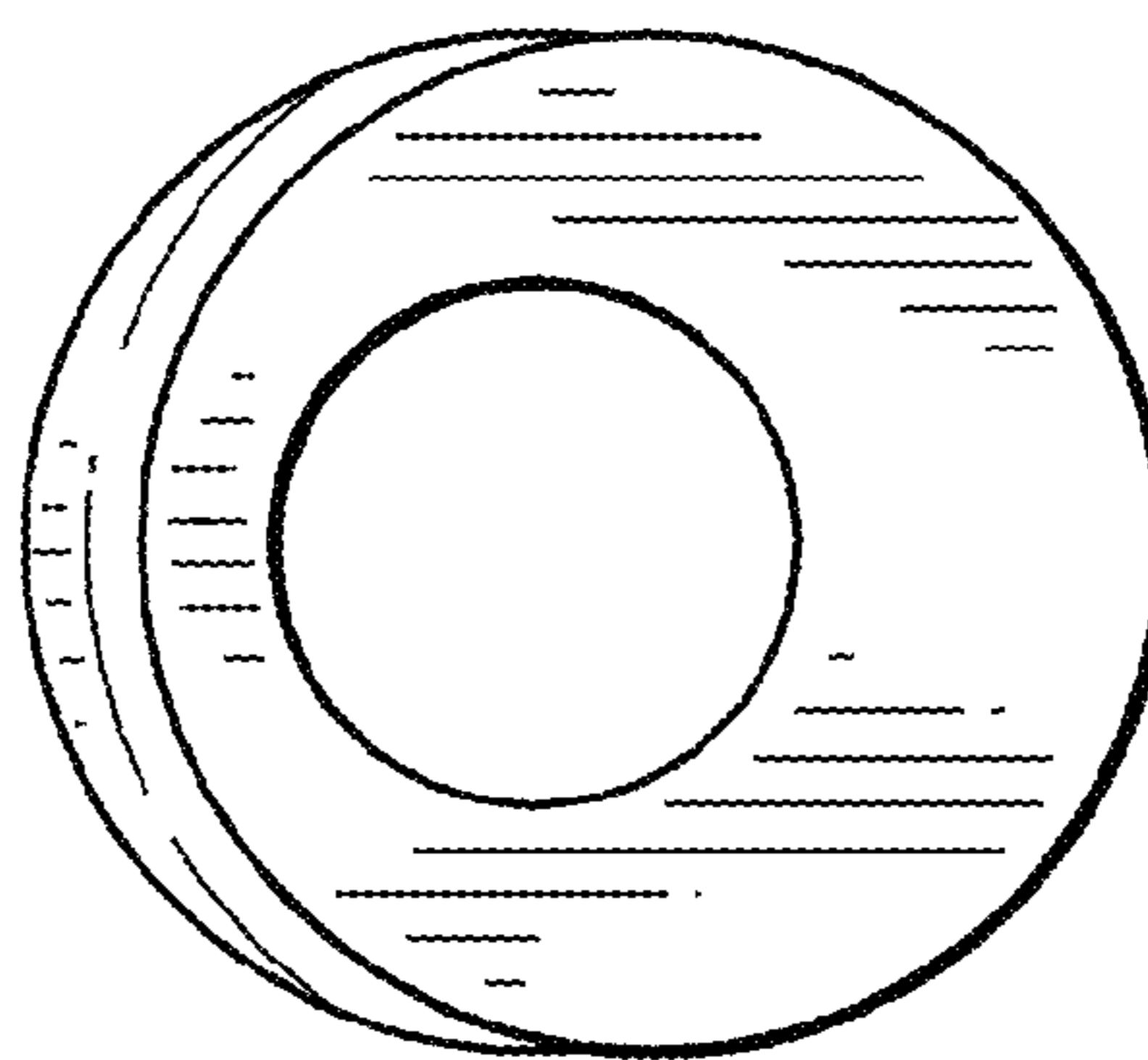

FIG. 8