



US00D756734S

(12) **United States Design Patent**  
**Deshpande et al.**

(10) **Patent No.:** **US D756,734 S**  
(45) **Date of Patent:** **\*\* May 24, 2016**

- (54) **HANDLE FOR A RATCHET ASSEMBLY**
- (71) Applicant: **Cequent Consumer Products, Inc.**,  
Solon, OH (US)
- (72) Inventors: **Dhananjay B. Deshpande**, Twinsburg,  
OH (US); **Cynthia Eubank**, Barberton,  
OH (US)
- (73) Assignee: **Cequent Consumer Products Inc.**,  
Solon, OH (US)
- (\*\*) Term: **15 Years**
- (21) Appl. No.: **29/530,923**
- (22) Filed: **Jun. 22, 2015**

**Related U.S. Application Data**

- (62) Division of application No. 29/476,156, filed on Dec. 11, 2013, now abandoned, which is a division of application No. 29/420,338, filed on May 8, 2012, now Pat. No. Des. 700,486.
- (51) **LOC (10) Cl.** ..... **08-05**
- (52) **U.S. Cl.**  
USPC ..... **D8/44**
- (58) **Field of Classification Search**  
USPC ..... D21/662, 682, 684; D8/14, 16, 19, 44,  
D8/499; D7/692  
CPC ..... A41D 13/082; A63B 21/00069; A63B  
21/0552; A63B 21/0557; A63B 21/154;  
A63B 2208/0204; A63B 23/12; A63B 31/08;  
B25B 25/00; B60P 7/083  
See application file for complete search history.

**References Cited**

**U.S. PATENT DOCUMENTS**

- 2,109,429 A \* 2/1938 Malm ..... A63B 31/08  
441/56
- D241,616 S \* 9/1976 Schreyer et al. .... D8/499
- 4,226,418 A \* 10/1980 Balfour ..... A63B 49/08  
16/DIG. 12
- 4,697,377 A \* 10/1987 Martin ..... A01K 87/08  
43/23
- 4,721,308 A \* 1/1988 Trimble ..... G06F 3/0338  
273/148 B
- D299,373 S \* 1/1989 Parker ..... D21/682
- D312,029 S \* 11/1990 Dumbrell ..... D7/692

- 4,977,621 A \* 12/1990 Richard ..... A41D 13/082  
2/161.1
- 5,404,615 A \* 4/1995 Wafer ..... B25B 13/48  
16/422
- D374,047 S \* 9/1996 Thielemann ..... D21/682
- D409,695 S \* 5/1999 Rojas ..... D21/680
- 5,899,444 A \* 5/1999 Rempe ..... B26B 29/00  
269/289 R
- D450,361 S \* 11/2001 Harms ..... D21/680
- D507,480 S \* 7/2005 Kopp ..... D8/383
- D527,606 S \* 9/2006 Jackson ..... D8/107
- D568,423 S \* 5/2008 Y'shua ..... D21/662
- D572,100 S \* 7/2008 Aganian ..... D8/44
- D627,200 S \* 11/2010 Rothman ..... D7/688
- 7,877,846 B1 \* 2/2011 Chen ..... B60P 7/0846  
24/68 CD
- D633,761 S \* 3/2011 Lion ..... D7/692
- D642,031 S \* 7/2011 Pehar ..... D8/44
- D698,400 S \* 1/2014 Potts ..... D21/680
- D700,486 S \* 3/2014 Deshpande ..... D8/44
- 2009/0283729 A1 \* 11/2009 Carlson ..... B25B 25/00  
254/218
- 2010/0011542 A1 \* 1/2010 Badrenas Buscart A44B 11/266  
24/163 R

\* cited by examiner

*Primary Examiner* — Susan E Krakower

*Assistant Examiner* — Roselynn Cody

(74) *Attorney, Agent, or Firm* — McDonald Hopkins LLC

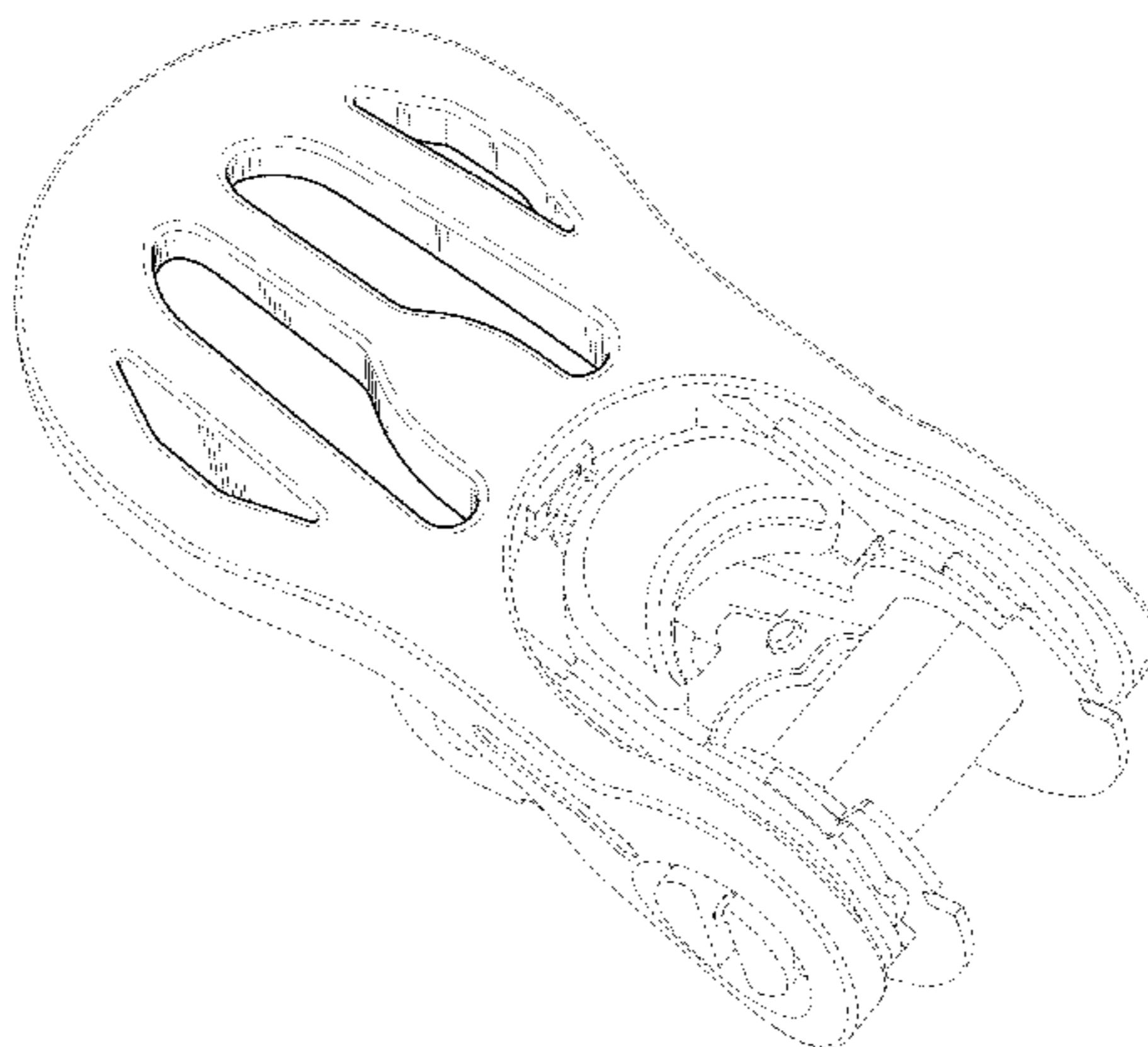
(57) **CLAIM**

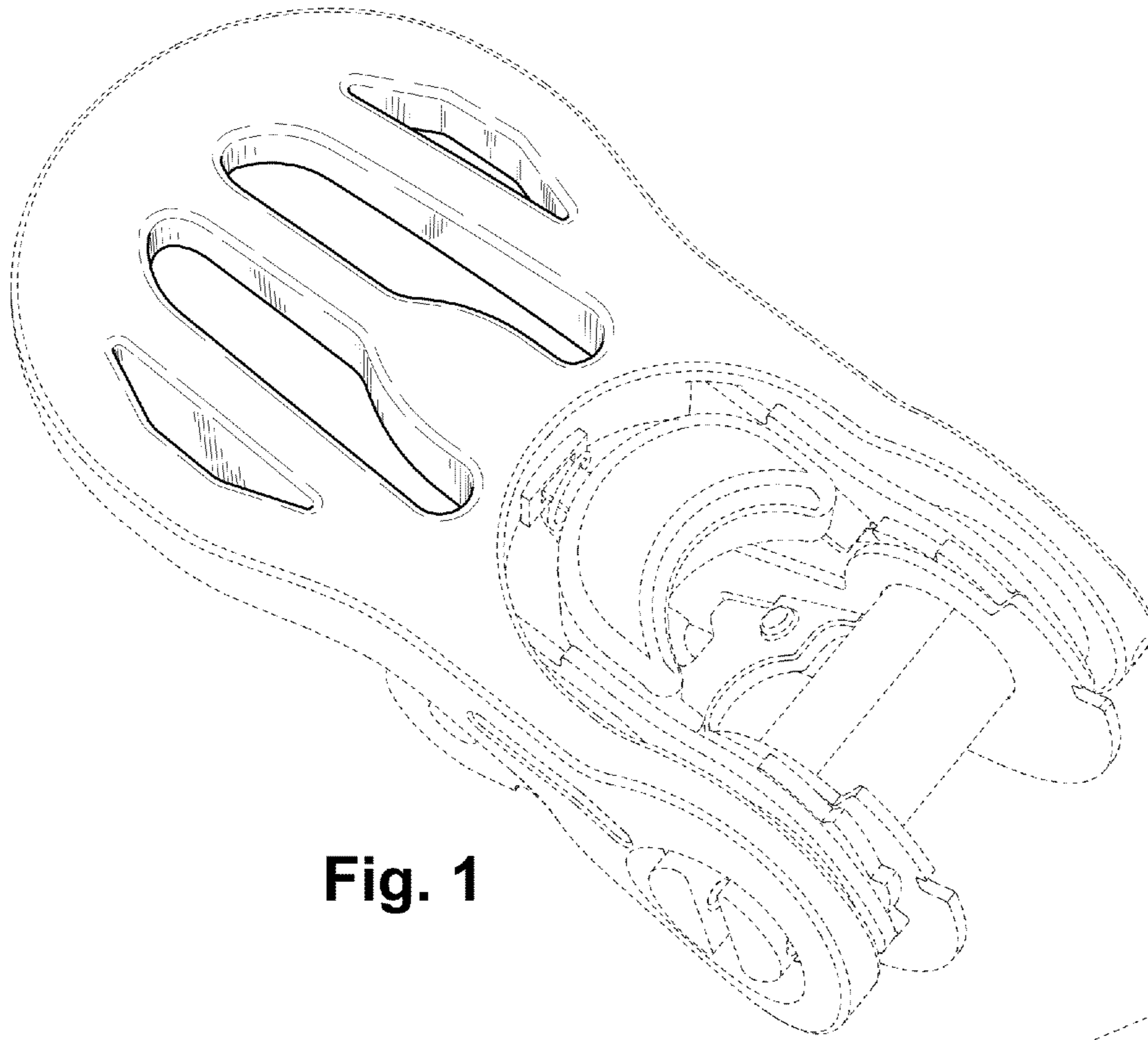
The ornamental design for a handle for a ratchet assembly, as shown and described.

**DESCRIPTION**

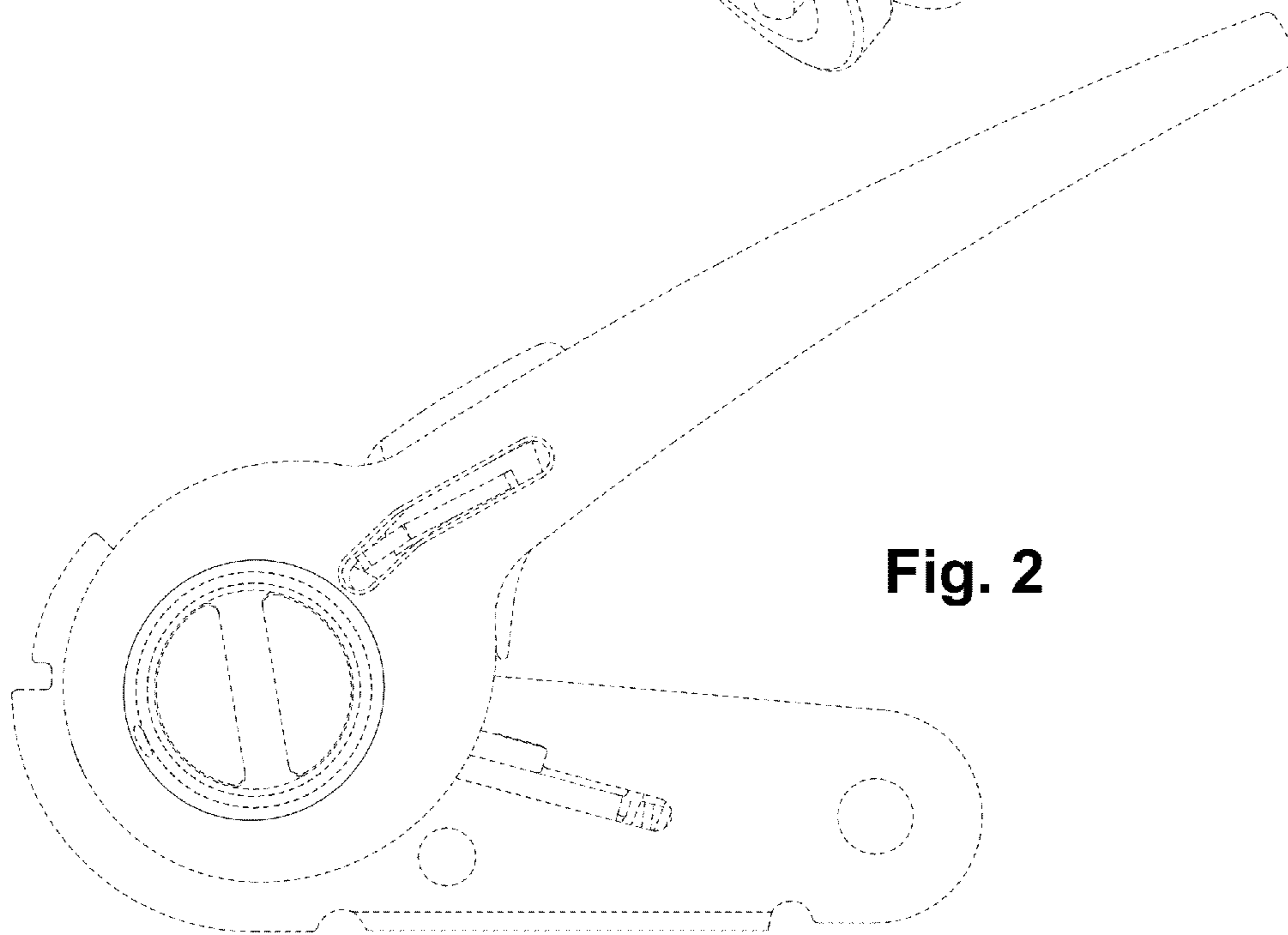
FIG. 1 is a top perspective view of a handle for a ratchet assembly showing our new design;  
 FIG. 2 is a side view thereof;  
 FIG. 3 is a top view thereof;  
 FIG. 4 is a bottom view thereof;  
 FIG. 5 is a front view thereof; and,  
 FIG. 6 is a rear view thereof.  
 The broken lines in the figures are included for the purpose of illustrating portions of a ratchet assembly and a handle of the ratchet assembly that form no part of the claimed design.

**1 Claim, 3 Drawing Sheets**

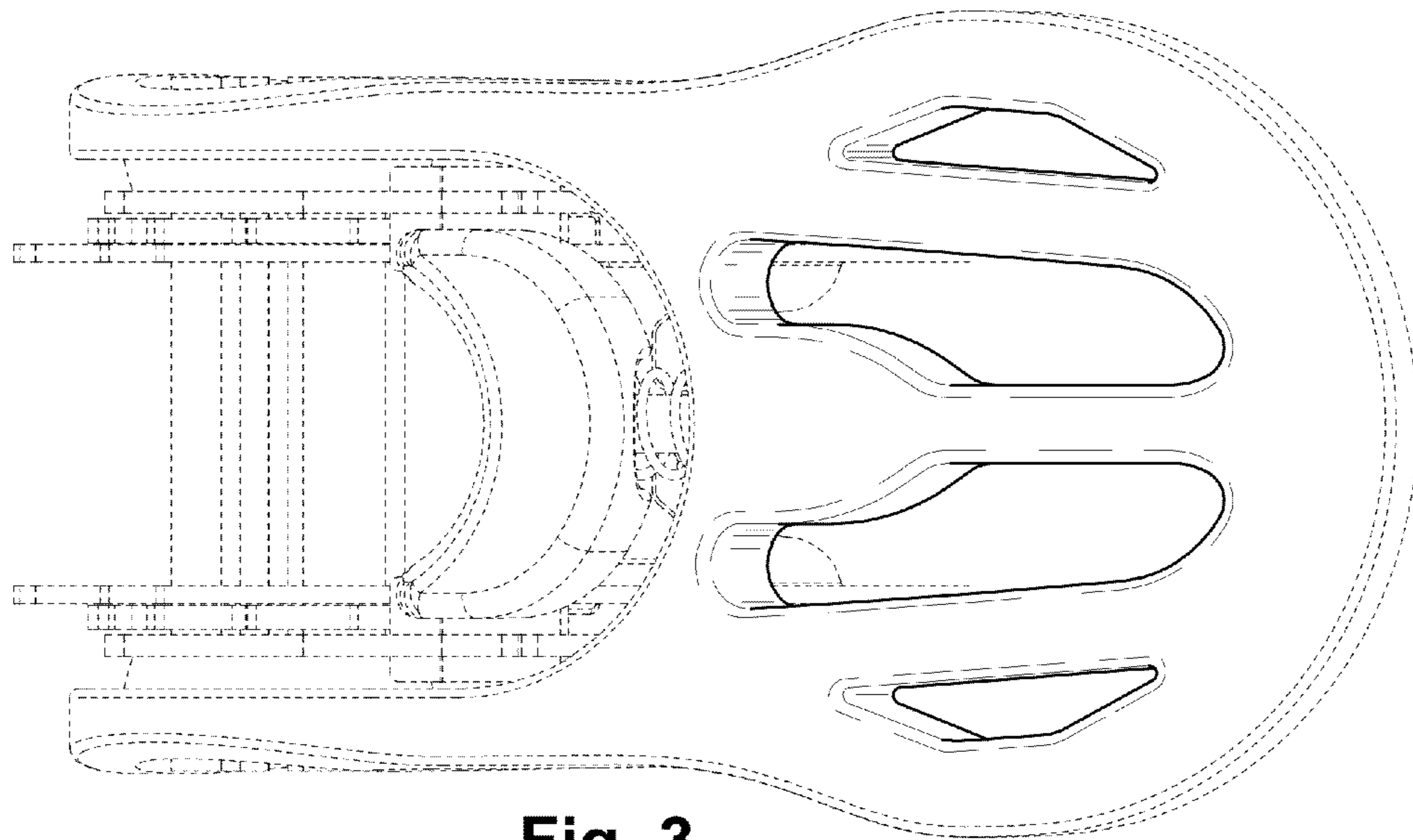




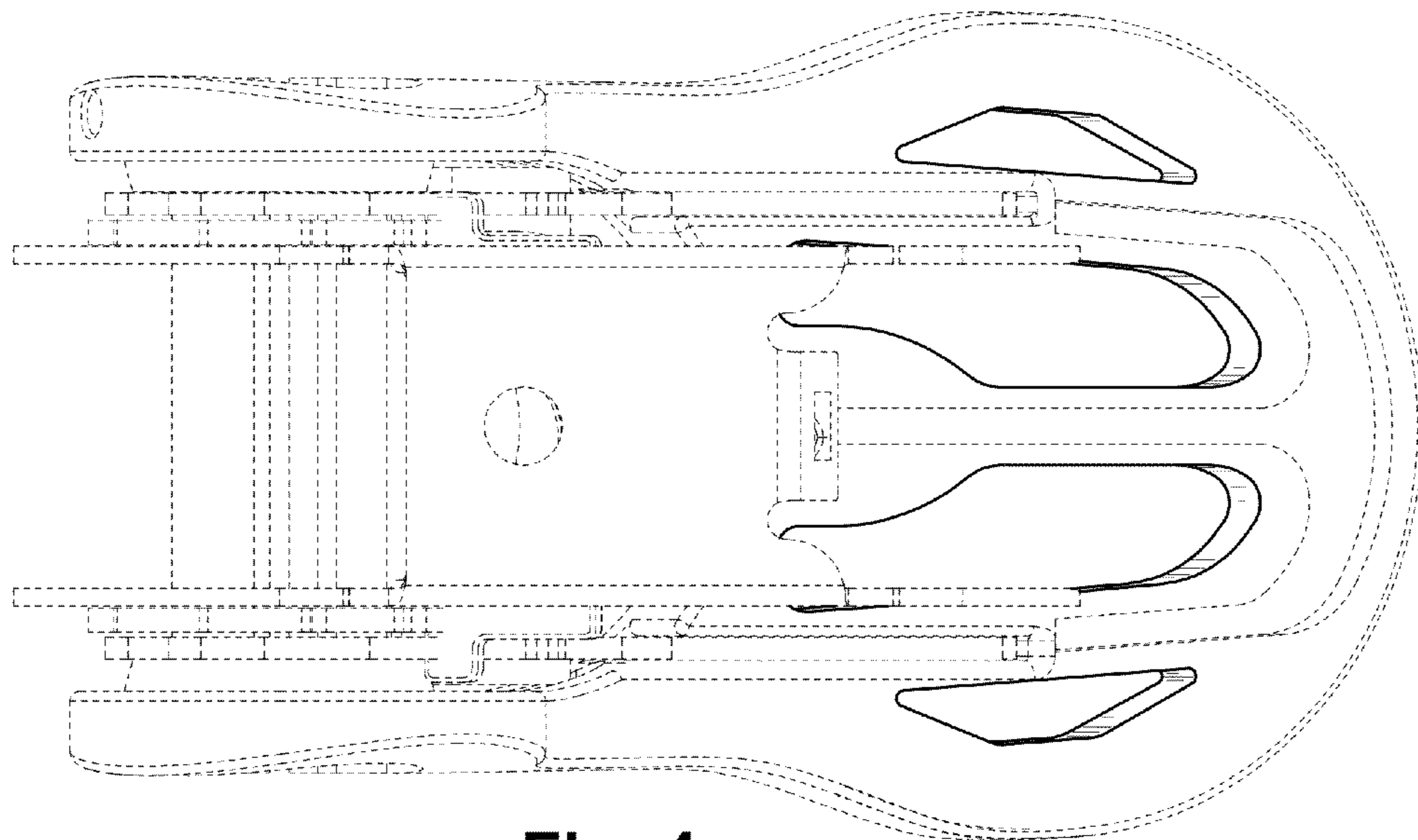
**Fig. 1**



**Fig. 2**



**Fig. 3**



**Fig. 4**

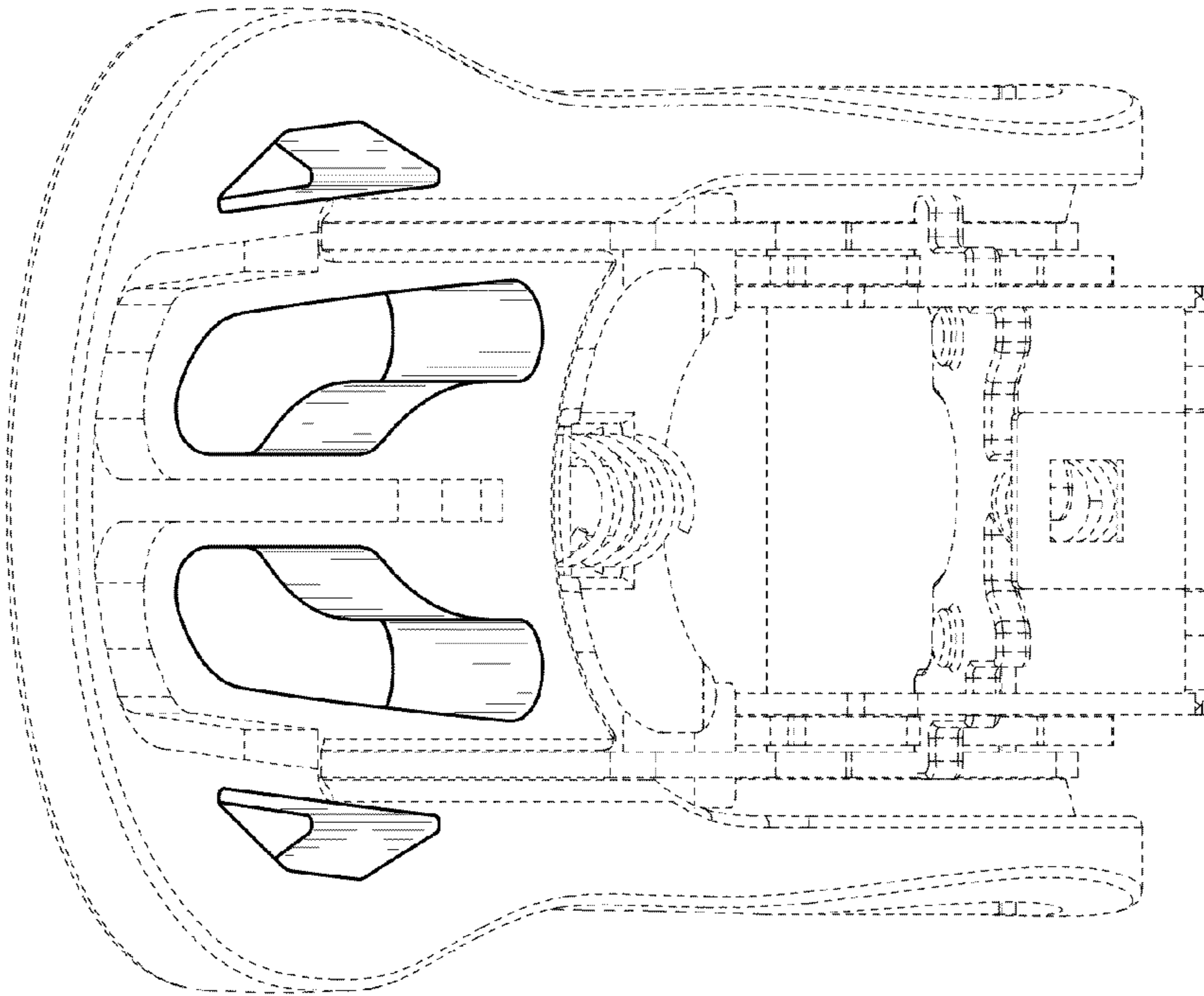


Fig. 6

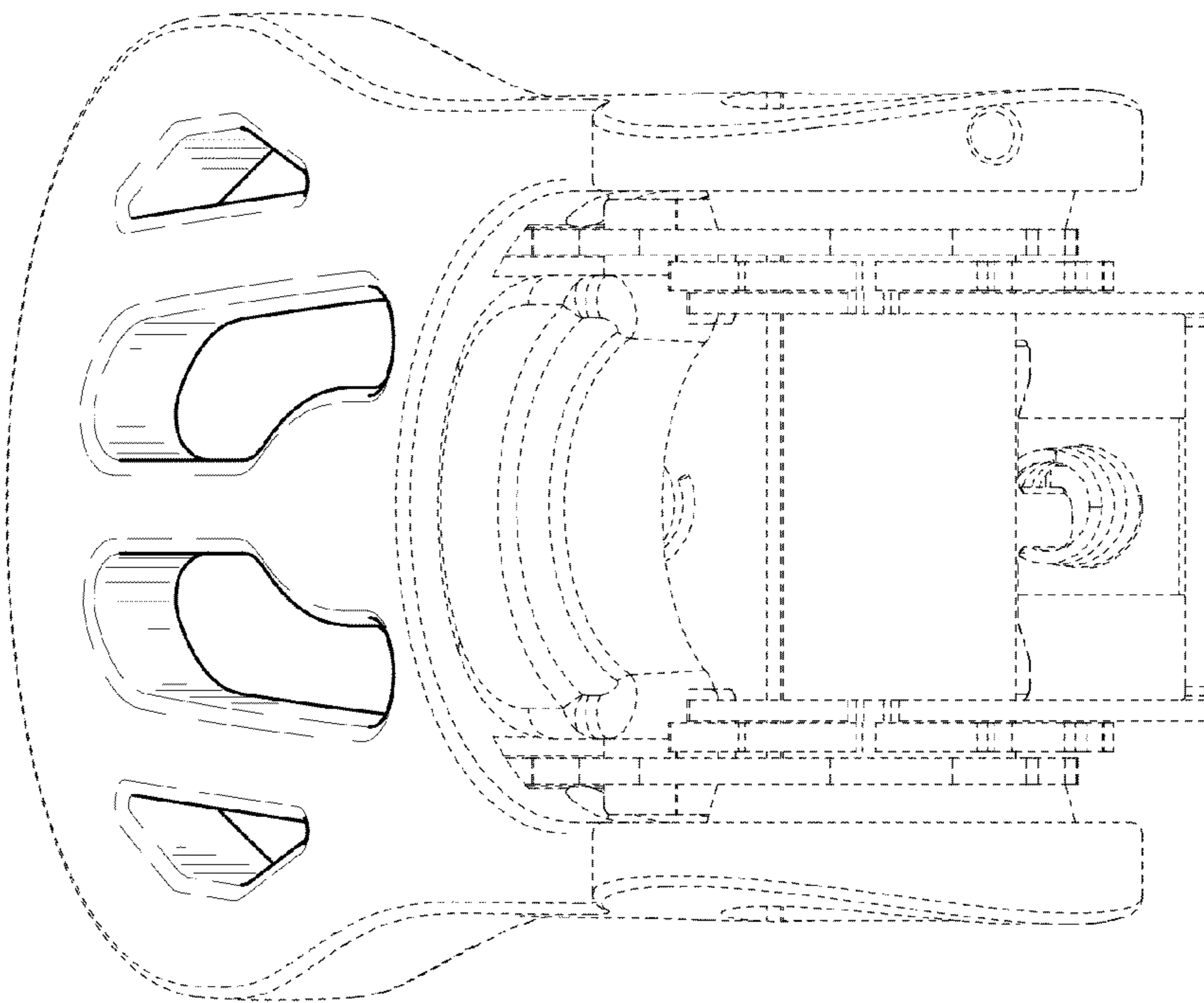


Fig. 5