



US00D756729S

(12) **United States Design Patent**
Macyszyn

(10) **Patent No.:** **US D756,729 S**

(45) **Date of Patent:** **** May 24, 2016**

(54) **SHOVEL HANDLE**

(71) Applicant: **Witold Macyszyn**, Sussex, NJ (US)

(72) Inventor: **Witold Macyszyn**, Sussex, NJ (US)

(**) Term: **14 Years**

(21) Appl. No.: **29/515,867**

(22) Filed: **Jan. 27, 2015**

(51) **LOC (10) Cl.** **08-01**

(52) **U.S. Cl.**
USPC **D8/10; D8/107**

(58) **Field of Classification Search**
USPC D8/1, 10, 11, 107; D21/398, 532
CPC A01B 1/00; A01B 1/02; A01B 1/022;
A01B 1/026; B25G 1/102; B25G 1/04;
B25G 1/00; Y10T 16/4713; E01H 5/02
See application file for complete search history.

(56) **References Cited**

U.S. PATENT DOCUMENTS

2,244,585	A *	6/1941	Tweit	A01B 1/00
				15/143.1
2,653,406	A *	9/1953	Grabiak	A01K 97/10
				294/58
3,751,094	A *	8/1973	Bohler	A01B 1/026
				16/426
D308,157	S *	5/1990	Maxian	D8/10
D314,318	S *	2/1991	Uimonen	D8/10
5,065,475	A *	11/1991	Watt	A01B 1/22
				15/145
5,331,720	A *	7/1994	Beckingham	A01B 1/00
				15/144.4
5,606,772	A *	3/1997	Ilic	A01B 1/00
				15/145
6,485,076	B1 *	11/2002	Chang	A01B 1/026
				254/131.5
7,971,914	B1 *	7/2011	Pladson	A01B 1/026
				16/426

D677,134	S *	3/2013	Stark	D8/10
2002/0109364	A1 *	8/2002	Graves	A01B 1/026
				294/58
2007/0209488	A1 *	9/2007	Nogueras	B25G 1/102
				81/489
2010/0139047	A1 *	6/2010	Eek	A01D 7/00
				16/430
2010/0320785	A1 *	12/2010	Trott	B25G 1/102
				294/58
2012/0048074	A1 *	3/2012	Mosher	B25G 1/06
				81/489
2012/0192540	A1 *	8/2012	Macyszyn	A01B 1/026
				56/400.01
2014/0132015	A1 *	5/2014	Stachowski	A01B 1/026
				294/51

* cited by examiner

Primary Examiner — Sheryl Lane

Assistant Examiner — Ieisha Price

(74) *Attorney, Agent, or Firm* — Mitchell Law PLLC;
Matthew W. Mitchell

(57) **CLAIM**

The ornamental design for a shovel handle, as shown and described.

DESCRIPTION

FIG. 1 is a front perspective view of the shovel handle of the present invention;

FIG. 2 is back view of the shovel handle of FIG. 1;

FIG. 3 is front view of the shovel handle of FIG. 1;

FIG. 4 is a right side view of the shovel handle of FIG. 1;

FIG. 5 is a left side view of the shovel handle of FIG. 1;

FIG. 6 is a bottom view of the shovel handle of FIG. 1;

FIG. 7 is a top view of the shovel handle of FIG. 1; and,

FIG. 8 is an environmental perspective view of the shovel handle.

The broken line showing of the shovel in FIG. 8 represent the environment of the claimed design and forms no part thereof.

1 Claim, 6 Drawing Sheets

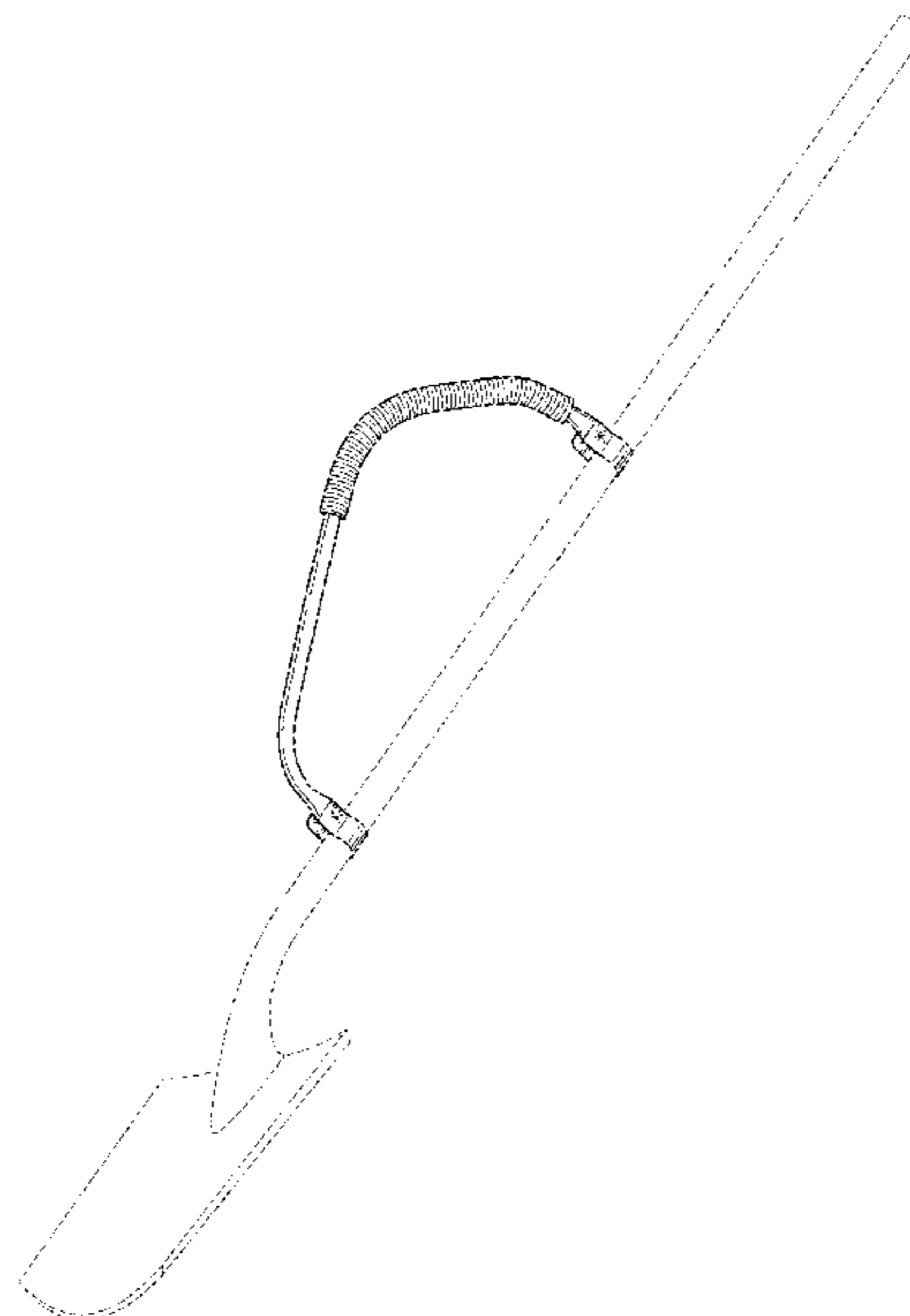

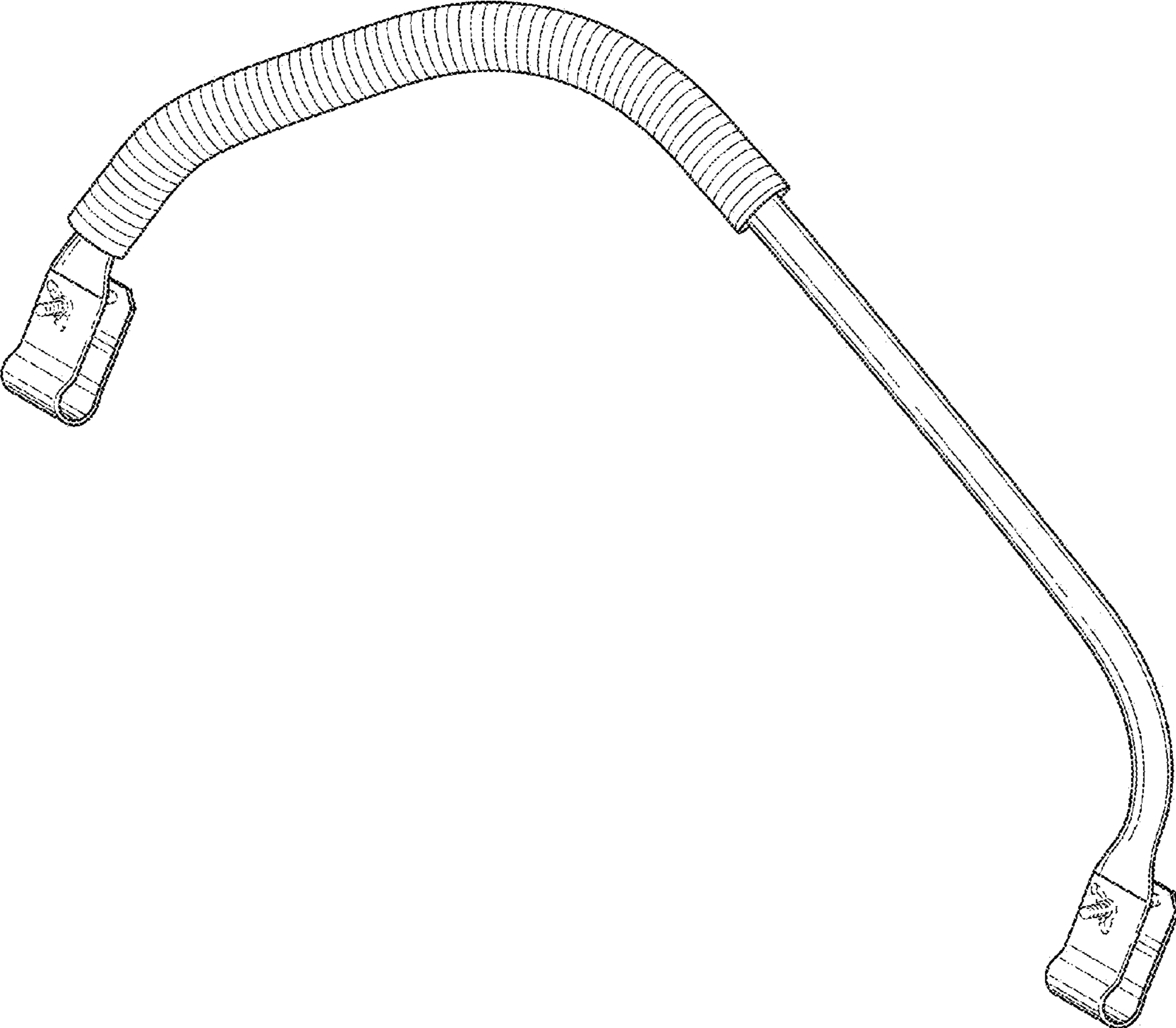

FIG. 1

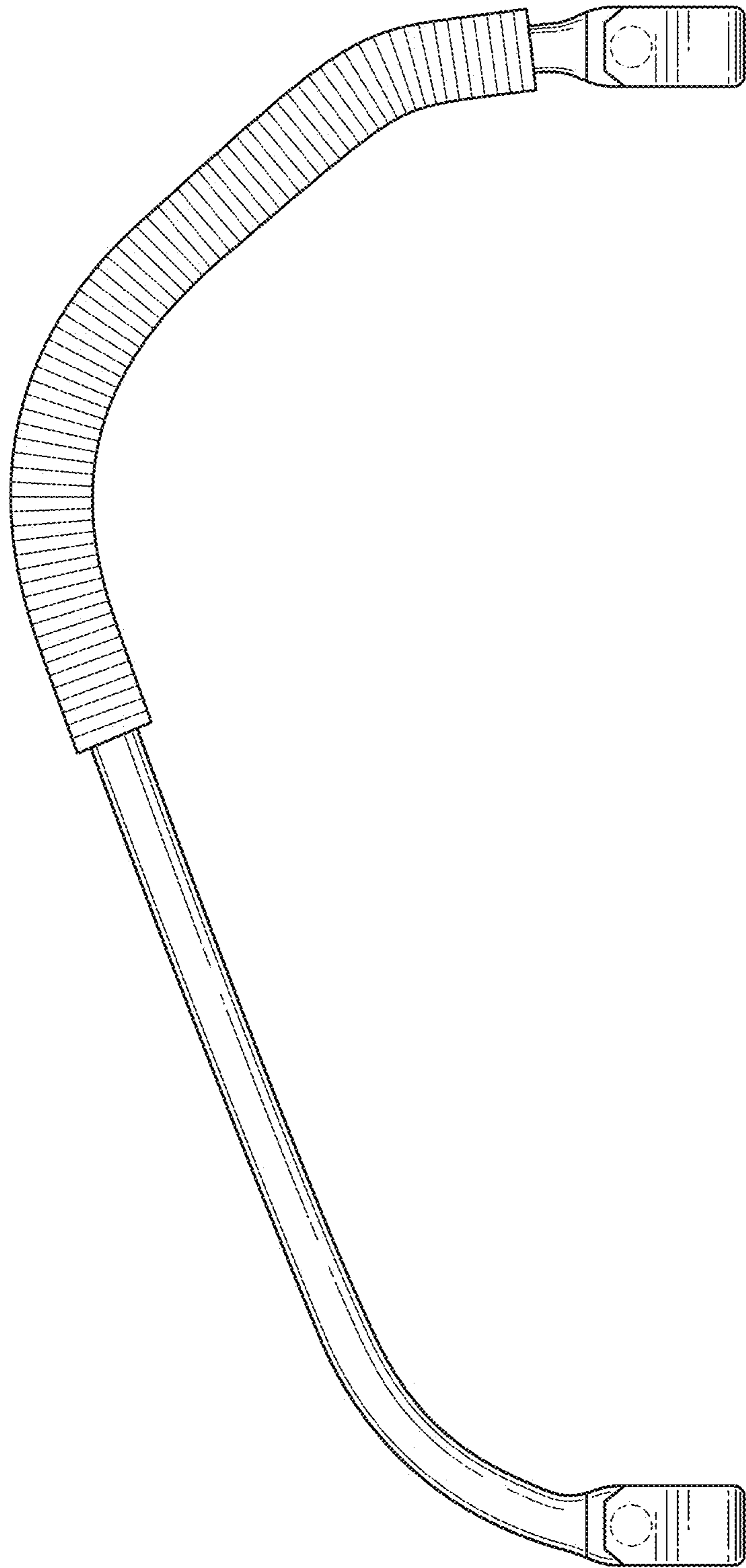

FIG. 2

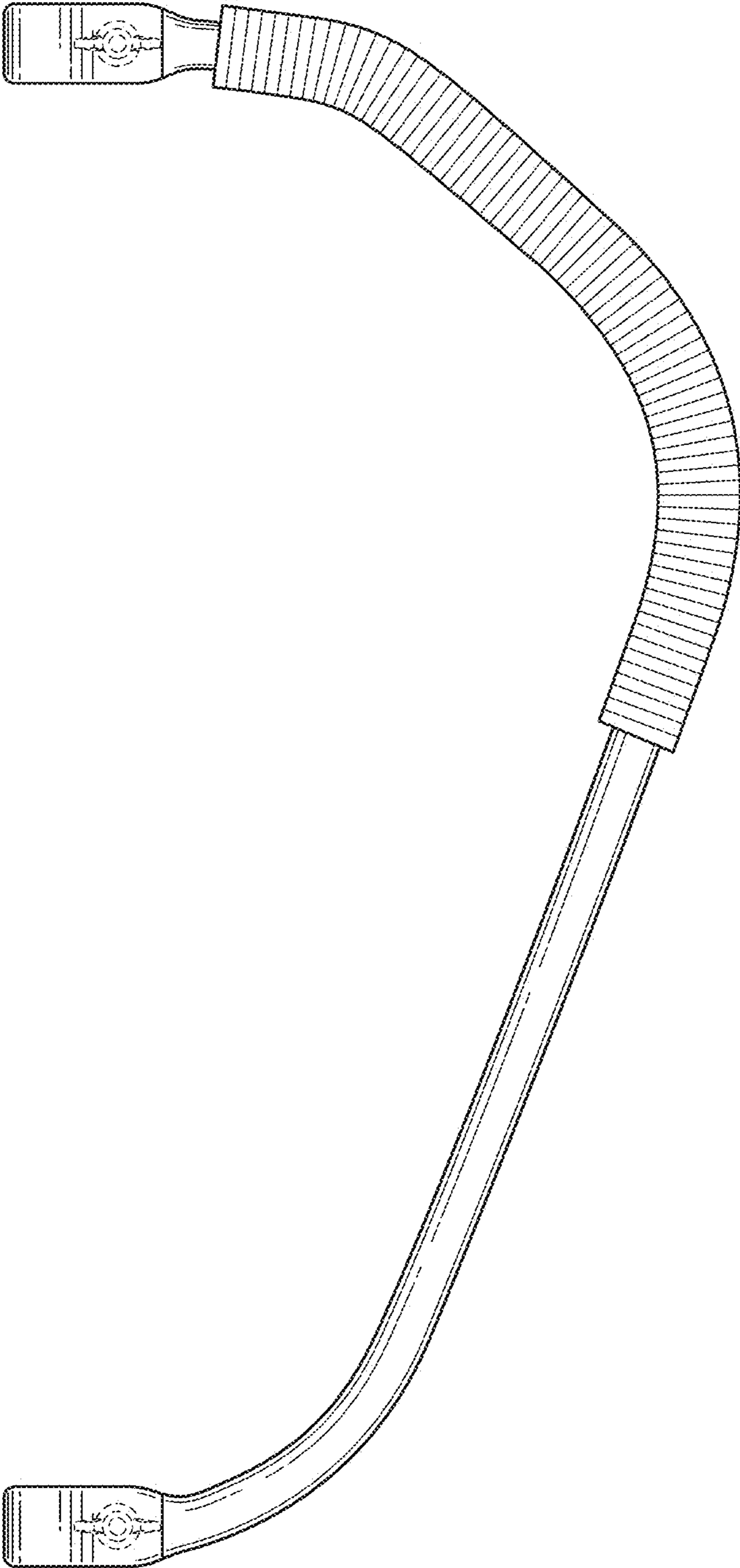

FIG. 3

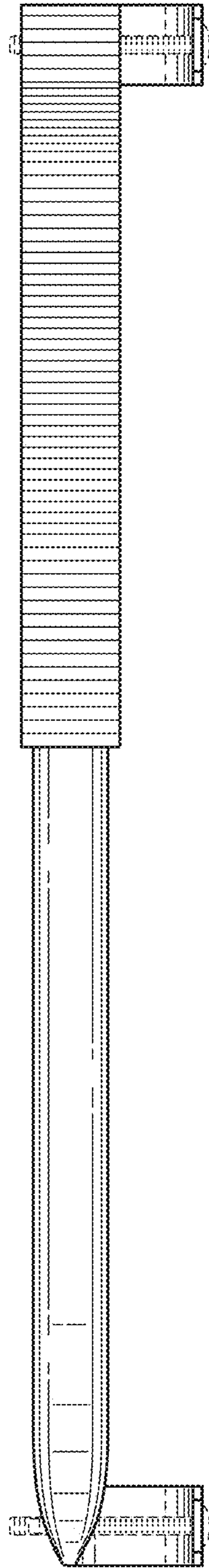

FIG. 4

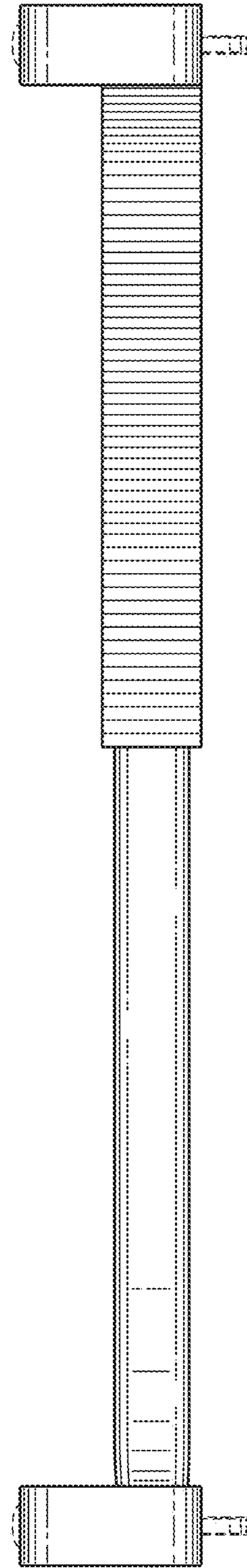

FIG. 5

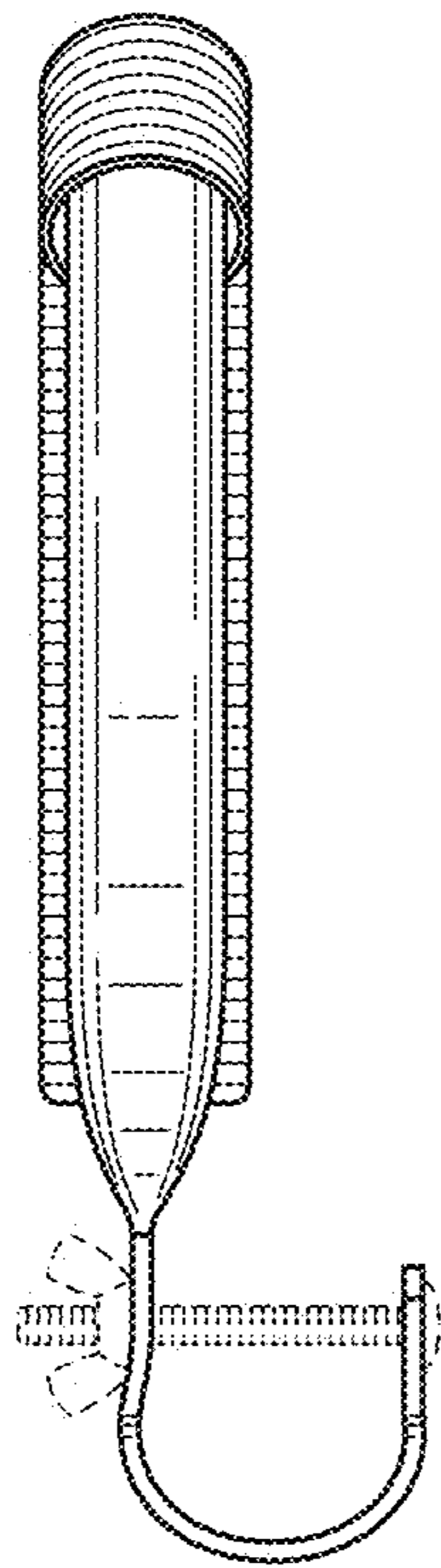

FIG. 6

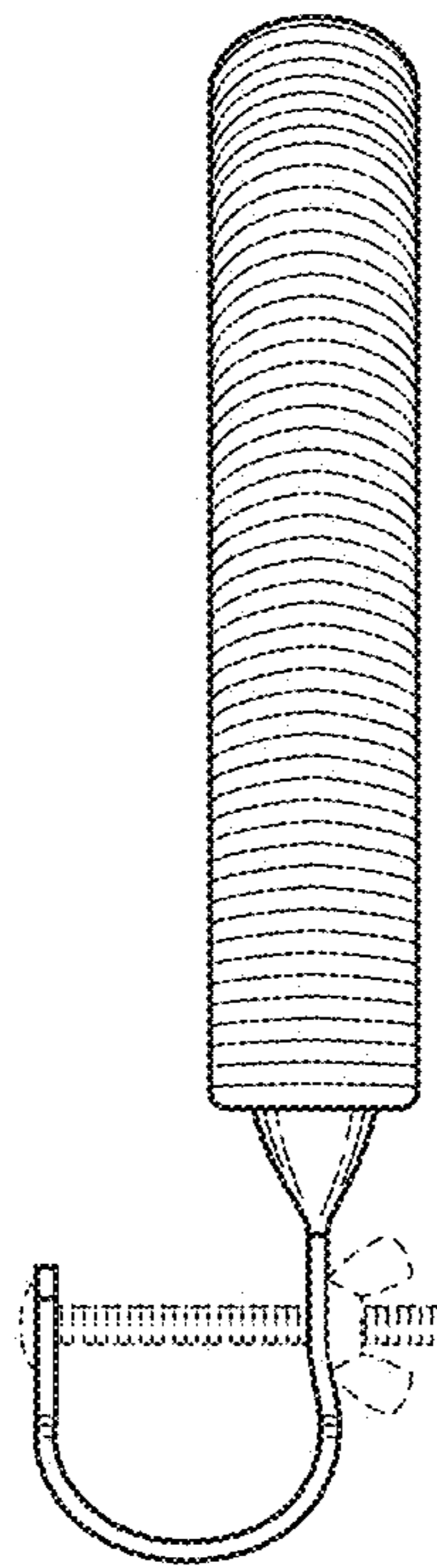

FIG. 7

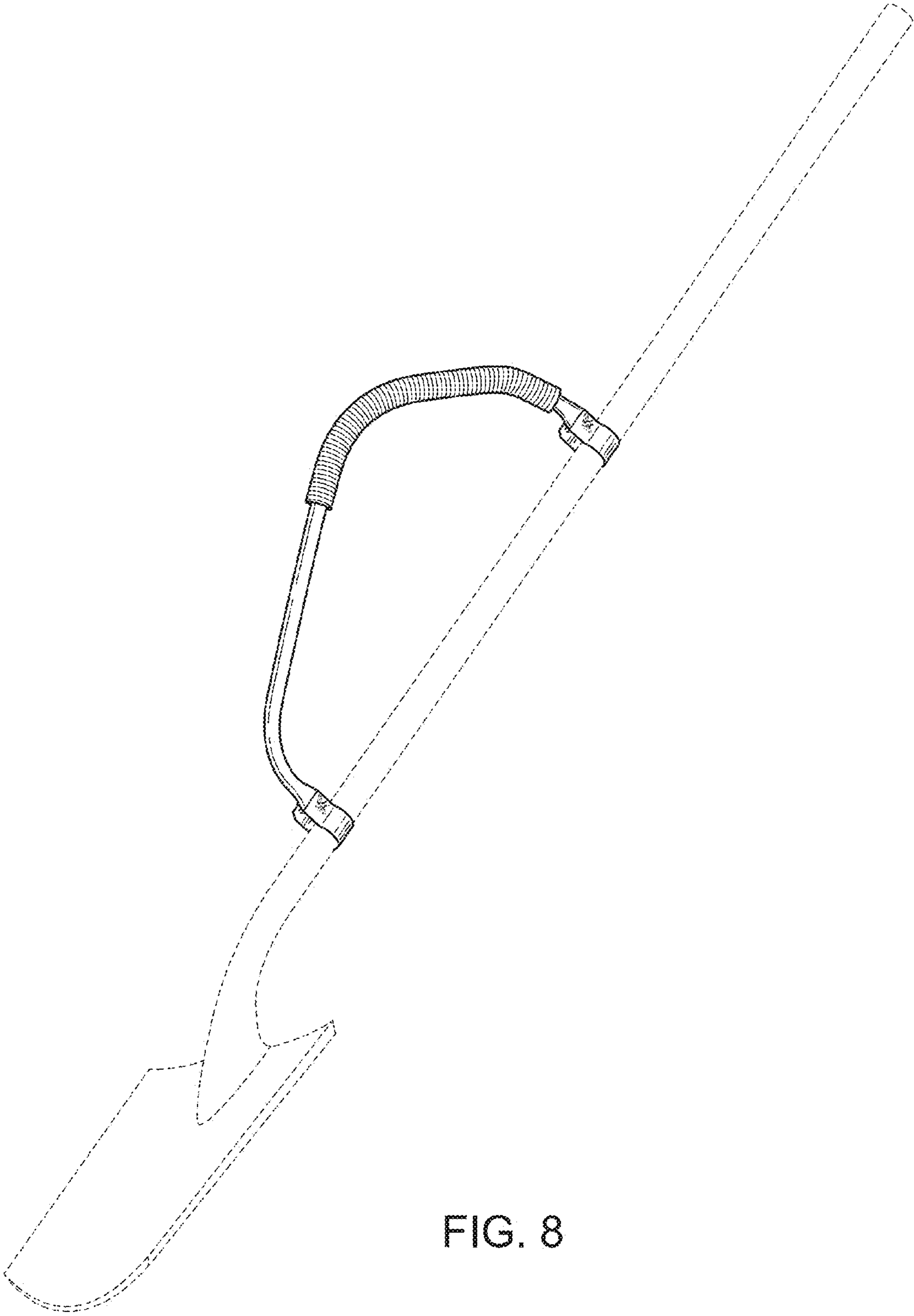

FIG. 8