

US00D756620S

(12) **United States Design Patent**
Boys

(10) **Patent No.:** **US D756,620 S**

(45) **Date of Patent:** **** May 24, 2016**

- (54) **SHOE SOLE**
- (71) Applicant: **Cole Haan LLC**, New York, NY (US)
- (72) Inventor: **Jack Boys**, Greenland, NH (US)
- (73) Assignee: **COLE HAAN LLC**, New York, NY (US)
- (**) Term: **15 Years**
- (21) Appl. No.: **29/542,314**
- (22) Filed: **Oct. 13, 2015**
- (51) **LOC (10) Cl.** **02-04**
- (52) **U.S. Cl.**
USPC **D2/960**; D2/947; D2/951; D2/957
- (58) **Field of Classification Search**
USPC D2/902, 906, 908, 916, 918, 925,
D2/946-962, 977; 36/3 B, 22 R, 24.5, 25 R,
36/28, 32 R, 34 R, 59 C, 67 A, 103
CPC A43B 13/00; A43B 13/02; A43B 13/023;
A43B 13/026; A43B 13/04; A43B 13/08;
A43B 13/10; A43B 13/12; A43B 13/14;
A43B 13/141; A43B 13/143; A43B 13/16;
A43B 13/18; A43B 13/181; A43B 13/187;
A43B 13/189; A43B 13/20; A43B 13/22;
A43B 13/223; A43B 13/24; A43B 13/28;
A43B 13/30; A43B 13/32; A43B 13/34;
A43B 13/36
See application file for complete search history.

(56) **References Cited**

U.S. PATENT DOCUMENTS

- D120,248 S * 4/1940 Sbicca D2/950
- 2,394,704 A * 2/1946 Loewer A43B 13/08
12/146 B
- D157,034 S 1/1950 Eldon
- D190,162 S * 4/1961 Hibbard 36/59 C
- D235,701 S * 7/1975 Famolare D2/947
- D265,018 S * 6/1982 Vermonet D2/954
- D266,798 S * 11/1982 Famolare, Jr. D2/950

- 4,364,190 A * 12/1982 Yonkers A43B 13/223
36/114
- D268,221 S * 3/1983 Argyropoulos D2/950
- D268,299 S * 3/1983 Argyropoulos D2/960
- 4,680,877 A 7/1987 Fink
- D294,537 S * 3/1988 Le D2/960
- 4,785,557 A * 11/1988 Kelley A43B 13/12
36/30 R
- 4,918,838 A * 4/1990 Chang A43B 1/0018
36/28
- D321,584 S * 11/1991 Mitsui D2/977
- D325,288 S * 4/1992 Richard D2/977
- 5,216,824 A * 6/1993 Blissett A43B 13/145
36/25 R
- D368,576 S * 4/1996 Assous D2/916
- D385,691 S * 11/1997 Egelja D2/946
- D394,143 S * 5/1998 Sink D2/960
- D398,743 S 9/1998 Rask
- D399,345 S * 10/1998 Koh D2/960
- 5,918,385 A * 7/1999 Sessa A43B 13/223
36/25 R
- D415,607 S * 10/1999 Merceron D2/951
- D430,723 S 9/2000 Kim

(Continued)

Primary Examiner — T. Chase Nelson

(74) *Attorney, Agent, or Firm* — Thompson Coburn LLP

(57) **CLAIM**

The ornamental design for a shoe sole, as shown and described.

DESCRIPTION

FIG. 1 is a perspective view of a shoe sole showing the new design;
 FIG. 2 is a medial side elevational view thereof;
 FIG. 3 is a lateral side elevational view thereof;
 FIG. 4 is a bottom plan view thereof;
 FIG. 5 is a top plan view thereof;
 FIG. 6 is a front elevational view thereof; and,
 FIG. 7 is a rear elevational view thereof.
 The broken lines showing the upper of the shoe and the tread pattern are for the purpose of illustrating environmental structure; the broken lines form no part of the claimed design.

1 Claim, 6 Drawing Sheets

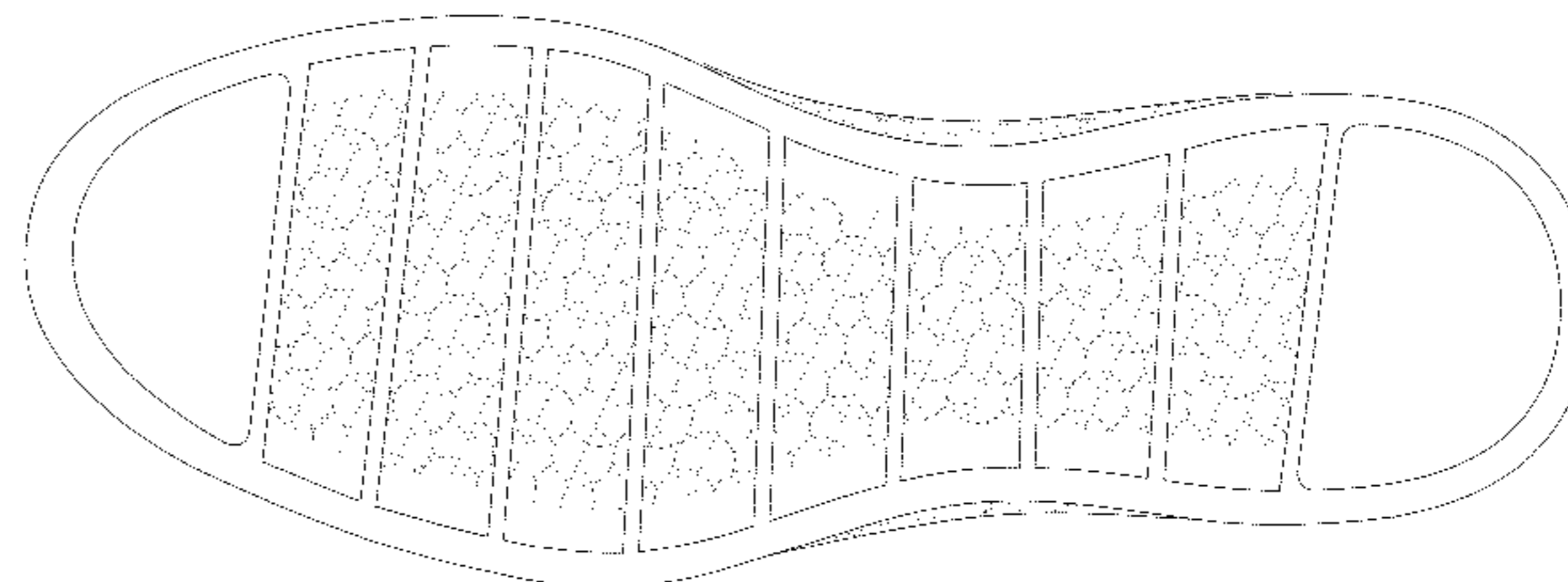
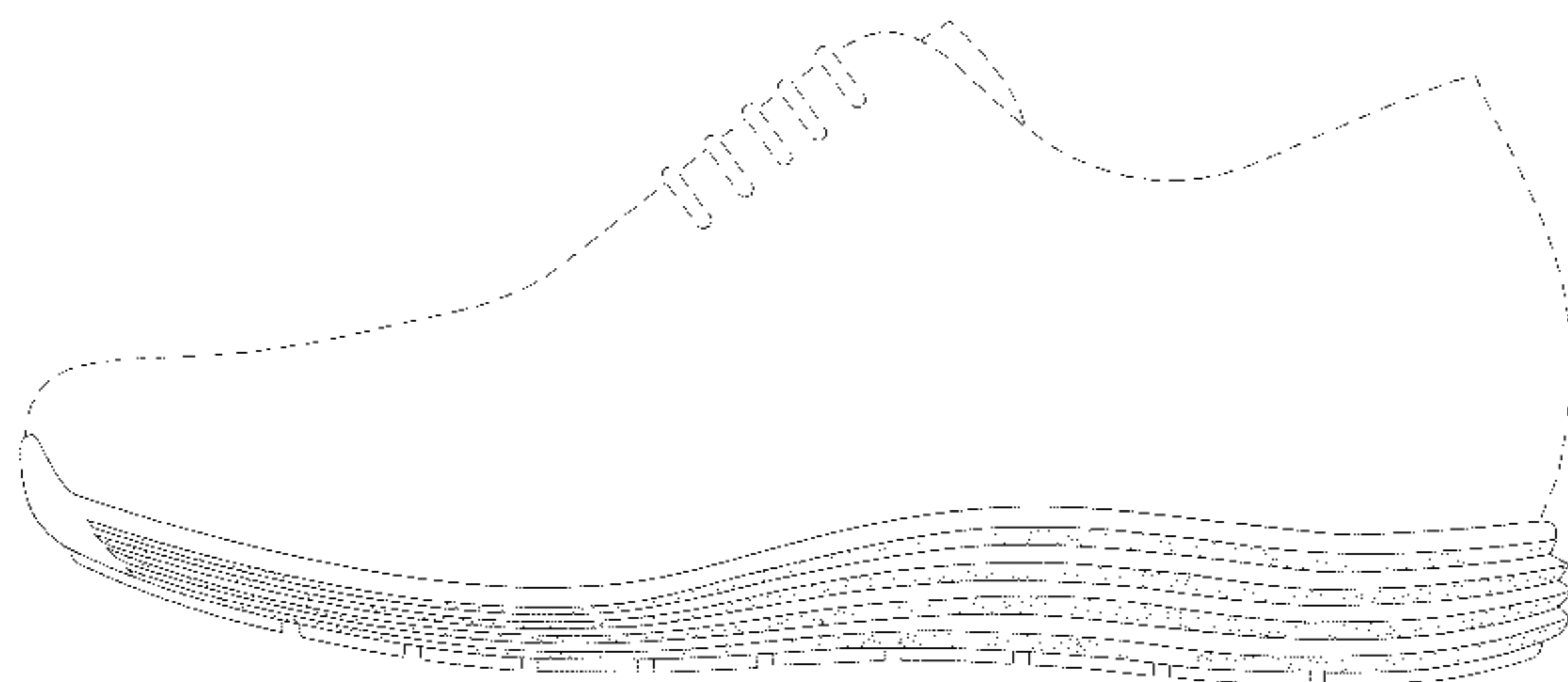

(56)

References Cited

U.S. PATENT DOCUMENTS

D432,292 S *	10/2000	Kim	D2/902	D709,676 S *	7/2014	Iachini	D2/902
D434,547 S *	12/2000	Kim	D2/902	D710,579 S *	8/2014	Williams, Jr.	D2/947
D466,278 S *	12/2002	Smith, III	D2/977	D713,625 S *	9/2014	Raasch	D2/947
D476,800 S *	7/2003	Fuerst	D2/957	D713,626 S	9/2014	Raasch	
D498,901 S	11/2004	Hawker et al.		D714,035 S *	9/2014	O'Connor	D2/947
D509,049 S	9/2005	McClaskie		D717,034 S *	11/2014	Bramani	D2/951
D511,617 S *	11/2005	Matis	D2/947	D730,034 S *	5/2015	Henderson	D2/951
7,047,670 B2 *	5/2006	Marvin	A43B 13/20 36/28	D730,035 S *	5/2015	Henderson	D2/947
D554,840 S *	11/2007	McClaskie	D2/953	D731,767 S *	6/2015	Lan	D2/947
D564,741 S *	3/2008	Covatch	D2/953	D735,453 S *	8/2015	Monroy	D2/951
D565,283 S *	4/2008	Smith	D2/902	D735,462 S *	8/2015	Pauk	D2/972
D568,594 S *	5/2008	Ringholz	D2/957	D737,039 S *	8/2015	Pauk	D2/972
D576,393 S *	9/2008	Kaufman	D2/947	D737,040 S *	8/2015	Pauk	D2/972
D579,649 S *	11/2008	McDowell	D2/970	D740,007 S *	10/2015	Lan	D2/951
D593,741 S *	6/2009	Vico	D2/951	D742,107 S *	11/2015	Kasprzak	D2/951
D611,692 S *	3/2010	Bizzo	D2/951	D743,153 S *	11/2015	Taylor	D2/947
D623,835 S	9/2010	Tzenos		D746,560 S *	1/2016	Verfl	D2/947
D624,291 S *	9/2010	Henderson	D2/946	D747,083 S *	1/2016	Verfl	D2/947
D632,876 S *	2/2011	Choi	D2/896	D747,600 S *	1/2016	Greenhalgh	D2/977
D634,108 S	3/2011	Tzenos		2005/0016021 A1 *	1/2005	Marvin	A43B 13/14 36/29
D636,567 S *	4/2011	Raysse	D2/946	2005/0217140 A1 *	10/2005	Melis	A43B 7/081 36/3 B
7,941,938 B2	5/2011	Yu et al.		2006/0048412 A1 *	3/2006	Kerrigan	A43B 3/0063 36/27
D643,189 S *	8/2011	Teteriatnikov	D2/946	2008/0141563 A1 *	6/2008	Meschan	A43B 13/186 36/107
D643,602 S	8/2011	Teteriatnikov		2009/0045546 A1 *	2/2009	Schindler	A43B 13/125 264/241
D659,958 S *	5/2012	Birkinhead	D2/946	2011/0232130 A1 *	9/2011	Boudreau	A43B 13/141 36/88
D660,568 S *	5/2012	Blakeslee	D2/951	2012/0005920 A1 *	1/2012	Alvear	A43B 13/125 36/28
D666,795 S *	9/2012	Shaffer	D2/947	2013/0232821 A1 *	9/2013	Schindler	A43B 13/181 36/103
D667,619 S *	9/2012	Blakeslee	D2/951	2013/0247422 A1 *	9/2013	Holt	A43B 13/122 36/103
D669,255 S *	10/2012	Birkinhead	D2/947	2014/0059883 A1 *	3/2014	Adeagbo	A43B 13/187 36/28
D671,306 S	11/2012	Tzenos		2014/0150298 A1	6/2014	Crowley et al.	
D671,723 S	12/2012	Teteriatnikov		2014/0259789 A1 *	9/2014	Dojan	A43B 1/0018 36/103
D672,123 S	12/2012	Williams, Jr.		2014/0305006 A1 *	10/2014	Azoulay	A43B 11/00 36/84
D675,003 S *	1/2013	Leon	D2/950	2015/0101215 A1 *	4/2015	Henderson	A43B 3/0057 36/103
D680,308 S *	4/2013	Hardman	D2/947	2015/0143722 A1 *	5/2015	Faggin	A43B 3/108 36/25 R
D684,348 S *	6/2013	Castellon	D2/951	2015/0150339 A1 *	6/2015	Van Hook	A43B 13/187 36/84
D685,166 S *	7/2013	Hatfield	D2/947				
D685,567 S	7/2013	Dolce					
D690,088 S	9/2013	Hardman					
D692,217 S *	10/2013	Fogg	D2/947				
D693,553 S *	11/2013	McClaskie	D2/951				
D694,497 S *	12/2013	Taylor	D2/947				
D694,498 S *	12/2013	Carboy	D2/947				
D694,499 S *	12/2013	Williams, Jr.	D2/947				
D696,852 S *	1/2014	Madore	D2/972				
8,732,986 B2 *	5/2014	Miner	A43B 13/141 36/25 R				
D707,949 S *	7/2014	VanHook	D2/972				

* cited by examiner

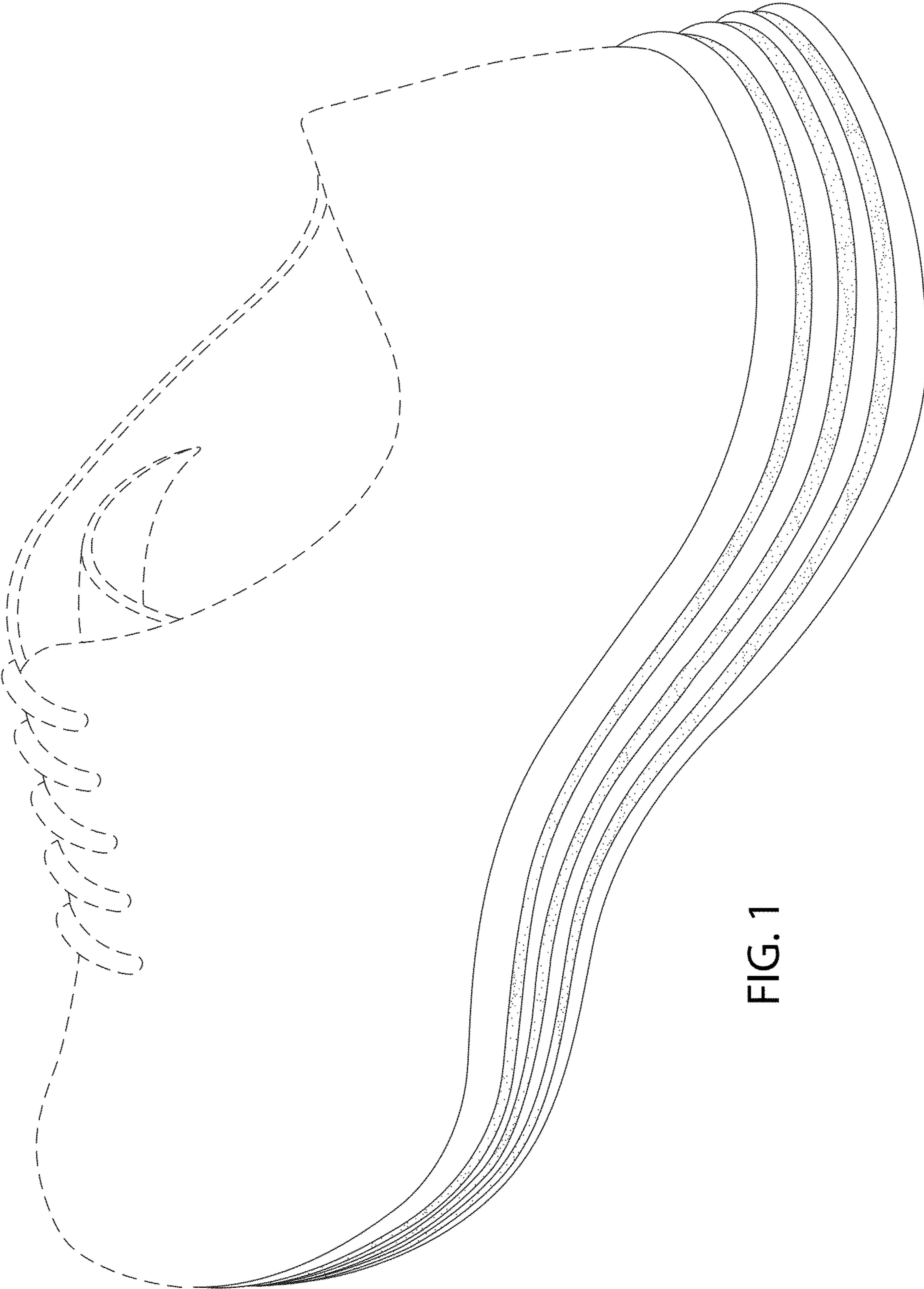

FIG. 1

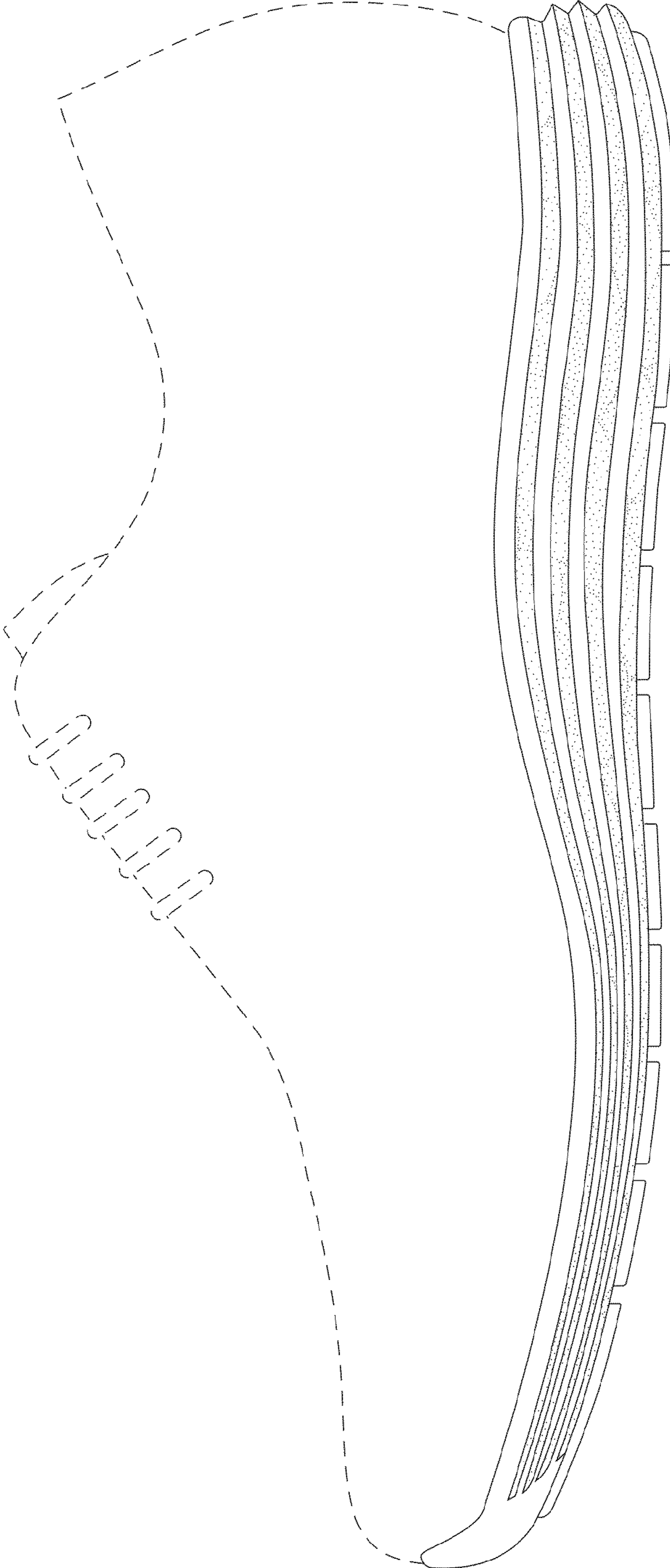

FIG. 2

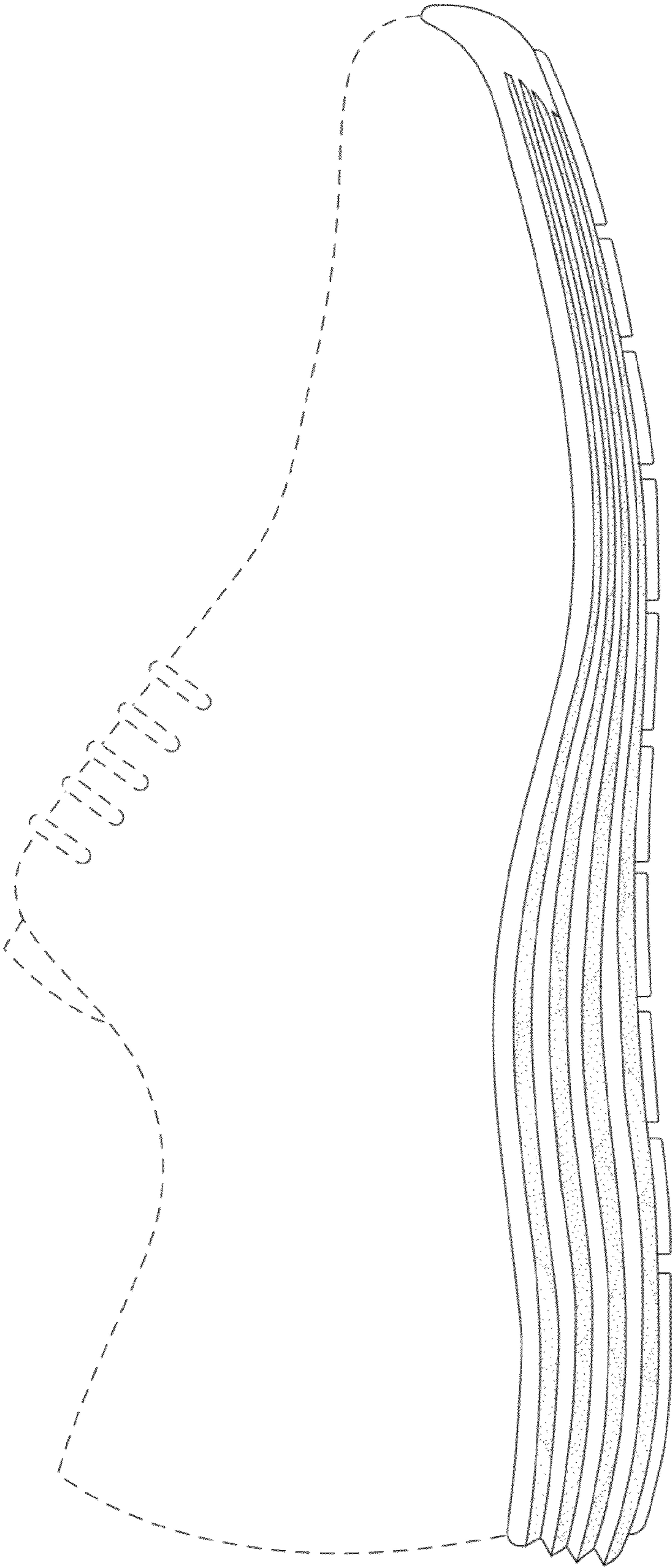

FIG. 3

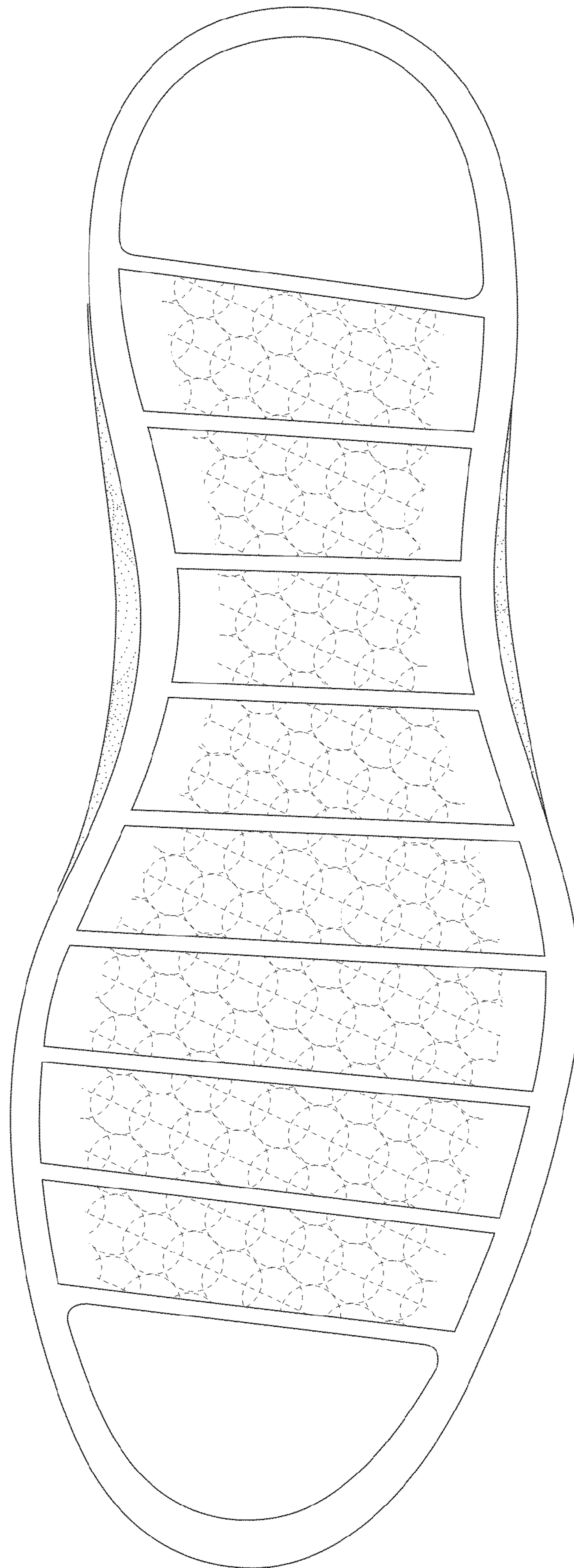

FIG. 4

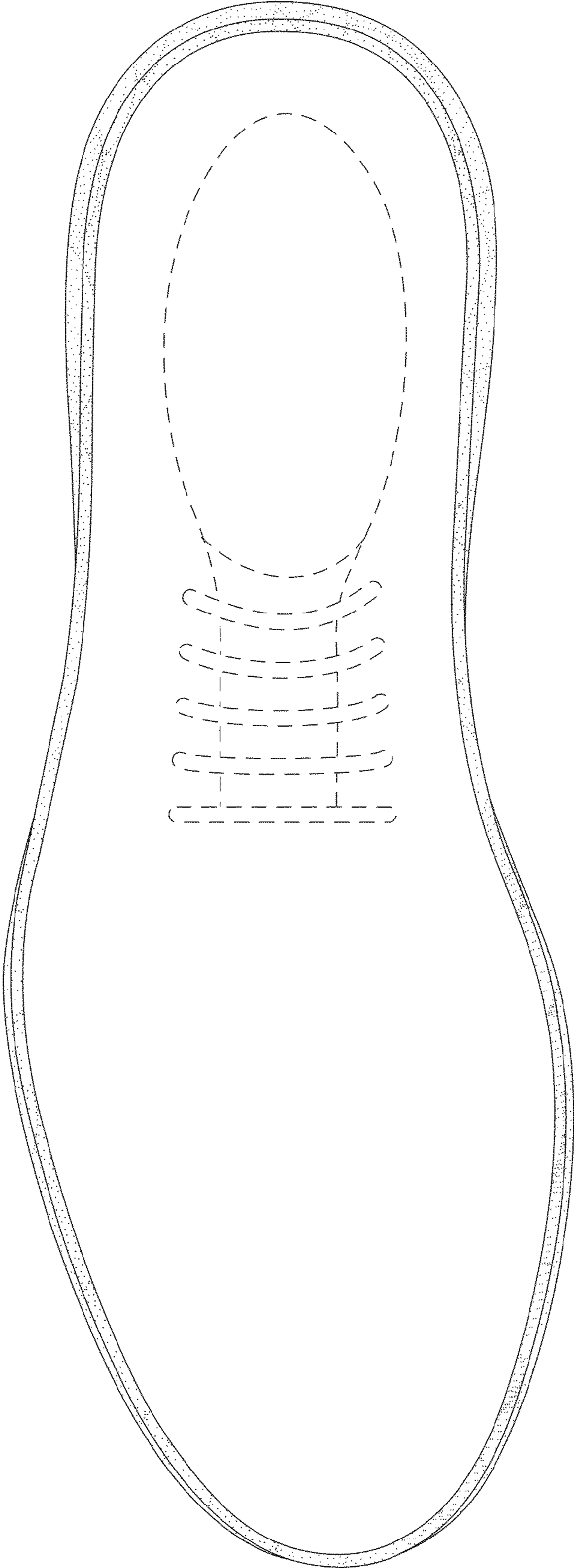

FIG. 5

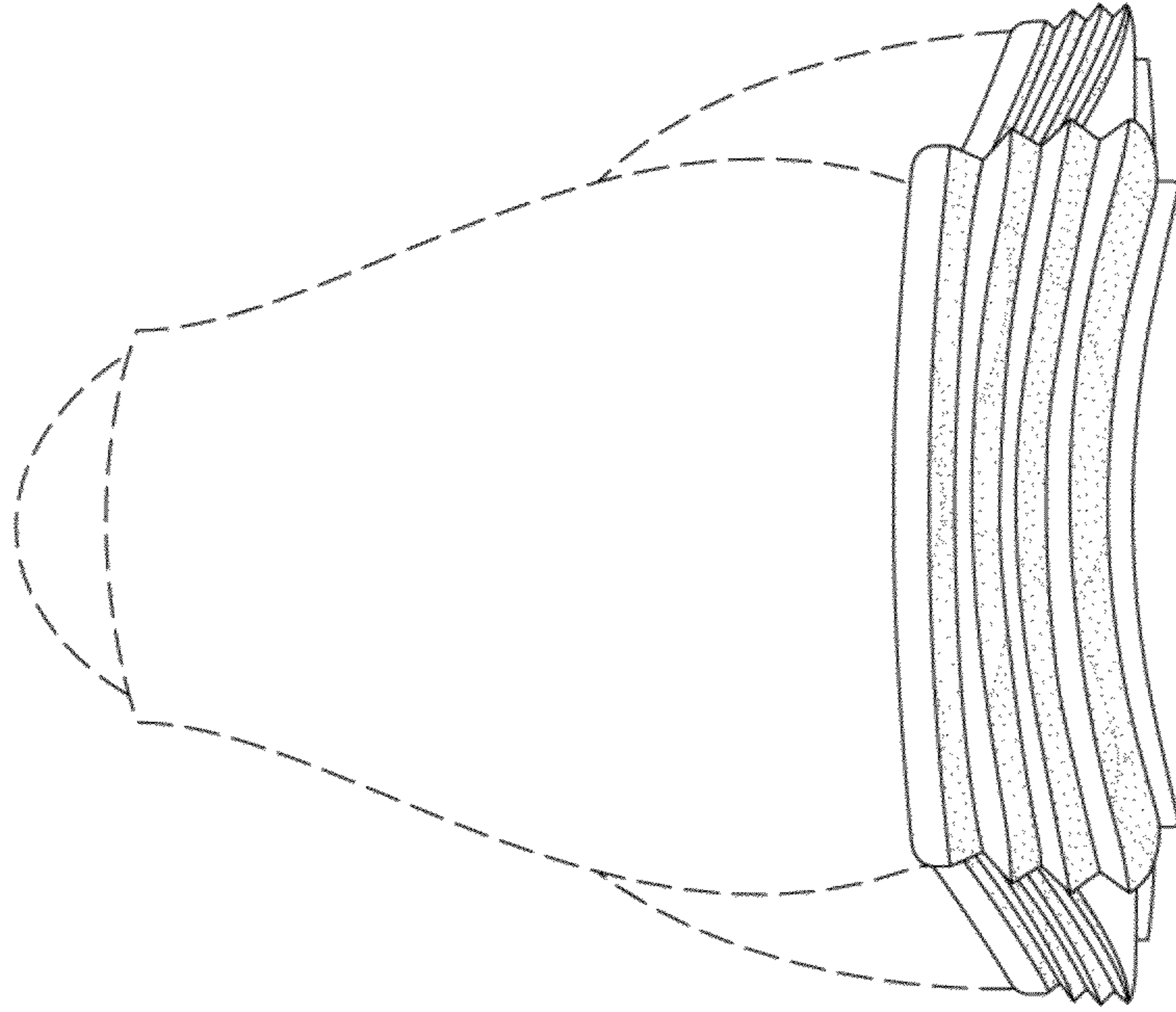

FIG. 7

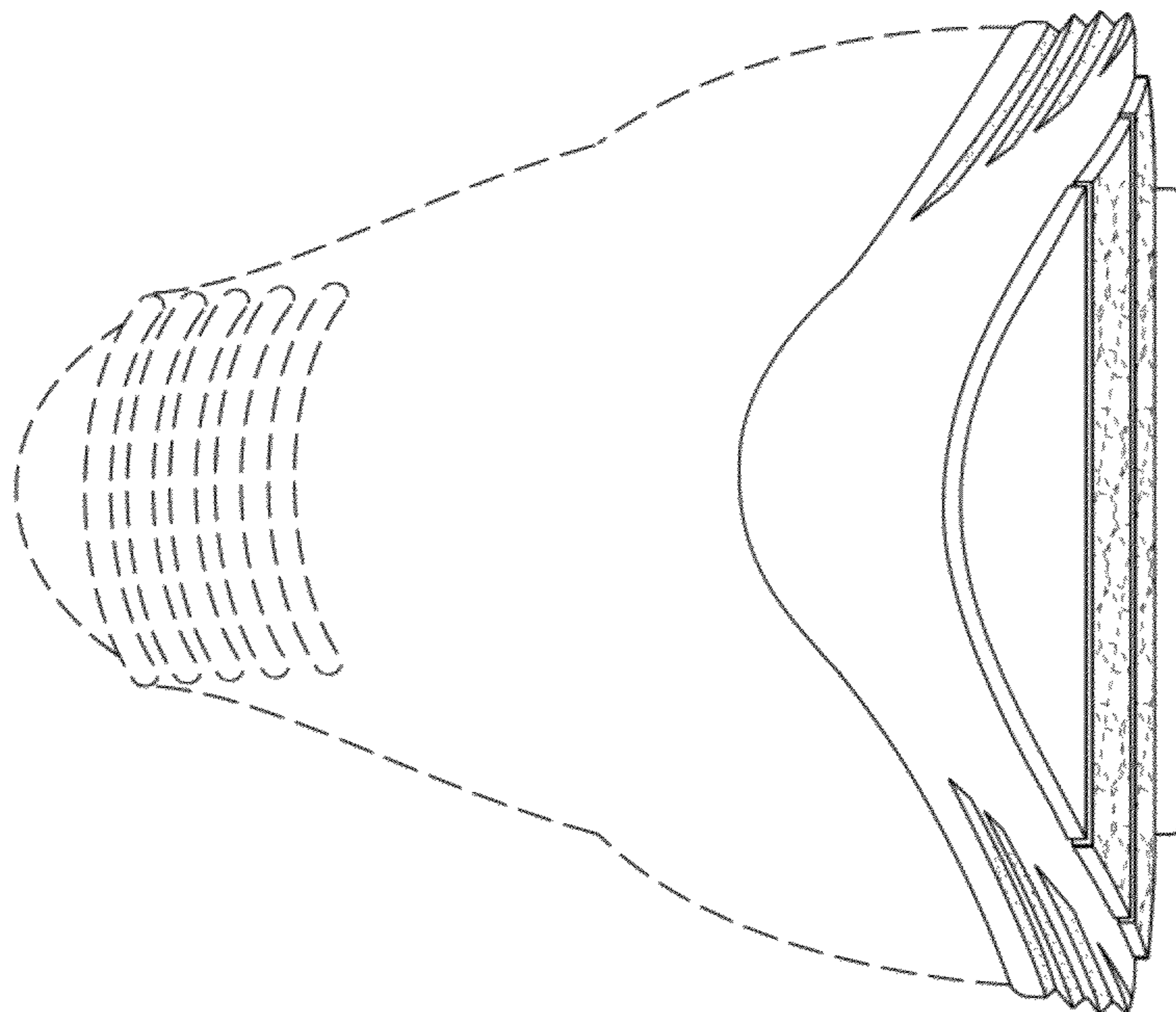

FIG. 6