



US00D756598S

(12) **United States Design Patent**
Pierorazio

(10) **Patent No.:** **US D756,598 S**

(45) **Date of Patent:** **** May 24, 2016**

(54) **PANTS WITH ADJUSTABLE LEG OPENINGS**

(71) Applicant: **Antonio Pierorazio**, Pompano Beach,
FL (US)

(72) Inventor: **Antonio Pierorazio**, Pompano Beach,
FL (US)

(**) Term: **14 Years**

(21) Appl. No.: **29/452,412**

(22) Filed: **Apr. 16, 2013**

(51) **LOC (10) Cl.** **02-02**

(52) **U.S. Cl.**
USPC **D2/742**

(58) **Field of Classification Search**
USPC D2/712, 731, 738, 742, 744, 748, 851,
D2/743, 713, 714, 715, 716, 736, 737, 739,
D2/857, 858; 2/244, DIG. 1, 247, 248, 219,
2/218, 220, 221, 222, 405, 408, 235, 236,
2/237, 919, 234, 232, 227, 231
CPC A41D 1/06; A41D 1/14; A41D 17/02;
A41D 27/20; A41D 27/201; A41D 27/205;
A41D 27/28; A41D 27/204; A41D 27/207;
A41D 27/208; A41D 2600/10; A41D 1/088;
A41D 1/086; A41D 1/084; A41D 1/082;
A41D 2300/32; A41F 9/00
See application file for complete search history.

(56) **References Cited**

U.S. PATENT DOCUMENTS

362,565	A *	5/1887	Yarwood	2/400
573,173	A *	12/1896	Aron	2/227
1,678,081	A *	7/1928	Rimpler	2/407
D151,885	S *	11/1948	Hamilton	D2/734
D461,035	S *	8/2002	Pellar	D2/742
D469,596	S *	2/2003	Schneider	D2/860
D481,195	S *	10/2003	Whisenant, Sr.	D2/742

D504,754	S *	5/2005	Rocha	D2/742
D530,485	S *	10/2006	Langmyr	D2/742
D534,709	S *	1/2007	Dipietro	D2/742
D561,979	S *	2/2008	Eichelberger	D2/742
D567,477	S *	4/2008	Smith et al.	D2/742
D597,282	S *	8/2009	Smith et al.	D2/742
D620,230	S *	7/2010	Rollins	D2/742
D626,718	S *	11/2010	Turner	D2/712
D626,719	S *	11/2010	Turner	D2/712
D629,999	S *	1/2011	Turner	D2/712
D633,688	S *	3/2011	Turner	D2/712
D669,247	S *	10/2012	Rollins	D2/742
D670,890	S *	11/2012	Pouches	D2/742
D721,871	S *	2/2015	Thorn et al.	D2/731
2005/0166298	A1 *	8/2005	Pierorazio	2/69
2009/0178174	A1 *	7/2009	Cash, Jr.	2/69

* cited by examiner

Primary Examiner — Cathron Brooks

Assistant Examiner — Melanie Pellegrini

(74) *Attorney, Agent, or Firm* — Miller Law Group, PLLC

(57) **CLAIM**

The ornamental design for a pants with adjustable leg openings, as shown and described.

DESCRIPTION

FIG. 1 is a front view of a first embodiment of pants with adjustable leg openings showing my new design;
FIG. 2 is a rear view thereof;
FIG. 3 is a left side view thereof;
FIG. 4 is a right side view thereof;
FIG. 5 is a top view thereof;
FIG. 6 is a bottom view thereof;
FIG. 7A is an enlarged partial view of a second embodiment of pants showing my new design wherein all elements of the pants are identical to the first embodiment except for the lace insert portion which is marked as 7A on FIG. 4; and,
FIG. 7B is an enlarged partial view thereof.

1 Claim, 4 Drawing Sheets

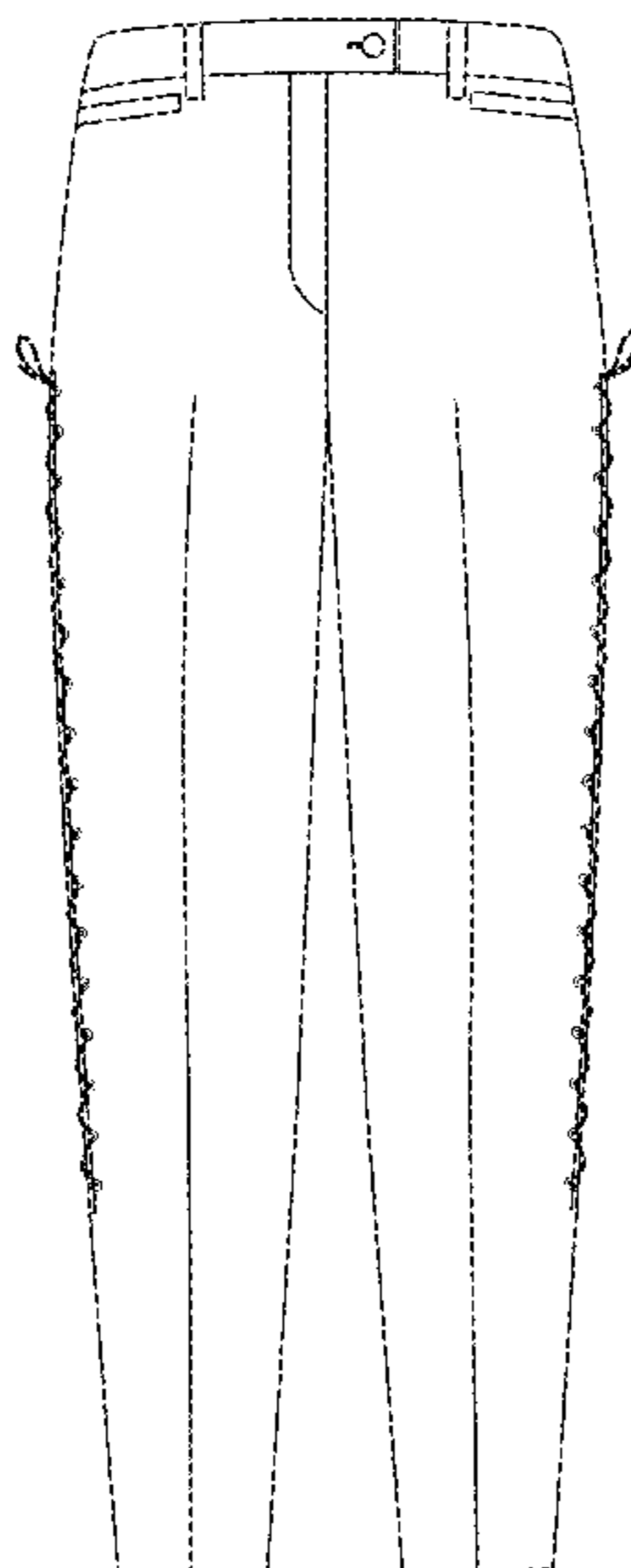

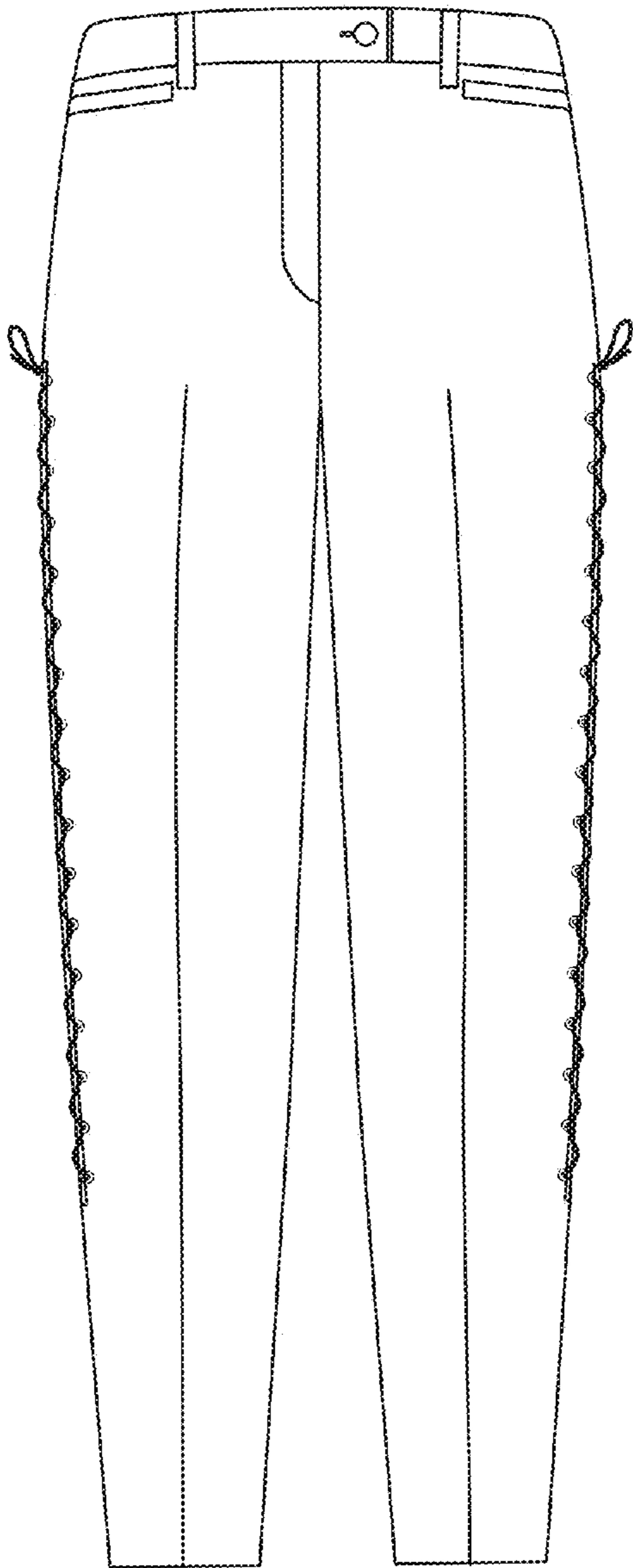

Fig. 1

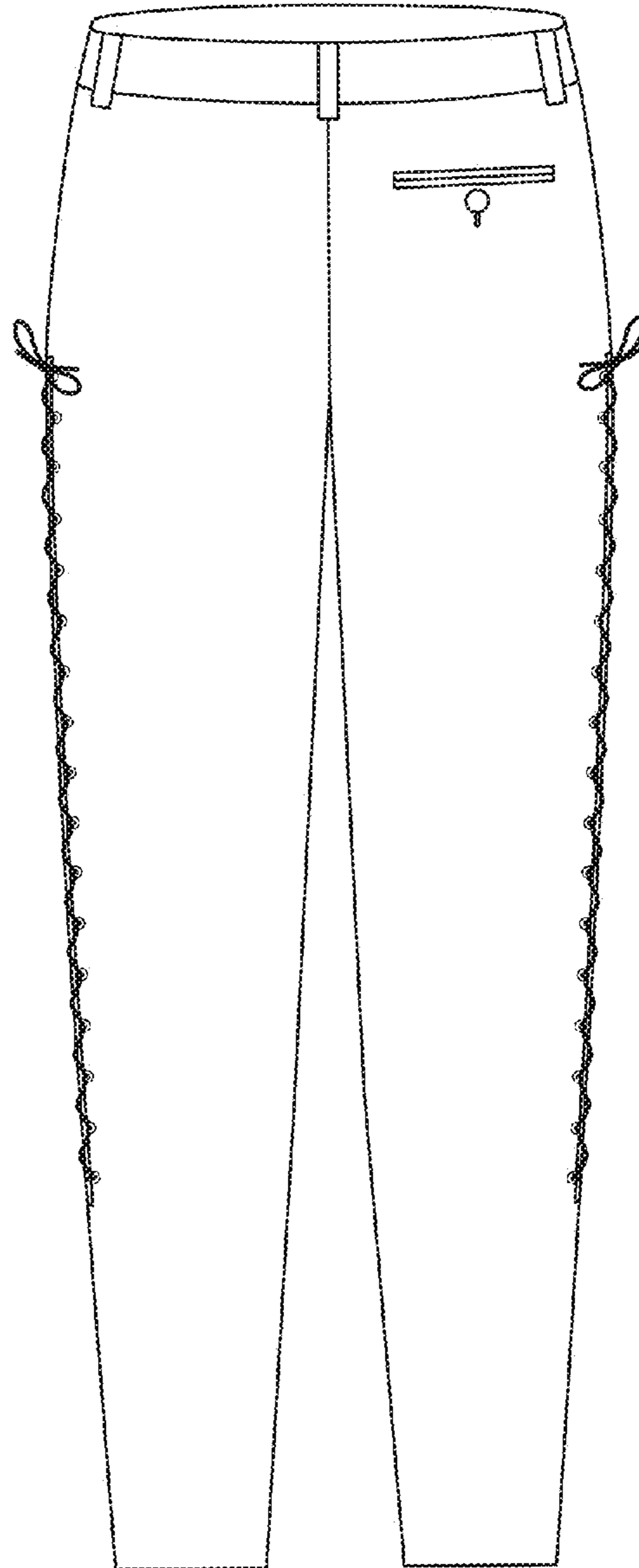

Fig. 2

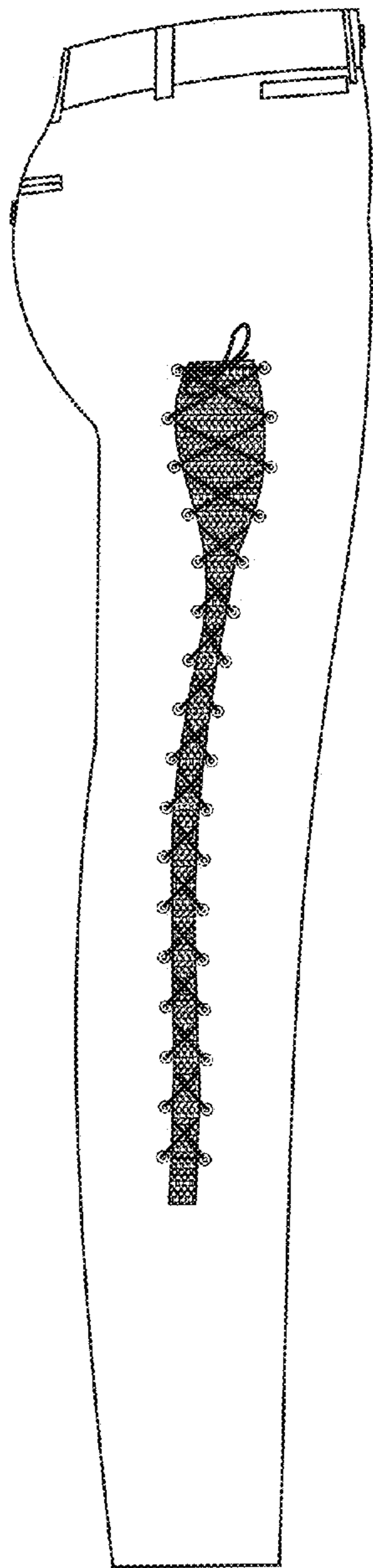

Fig. 3

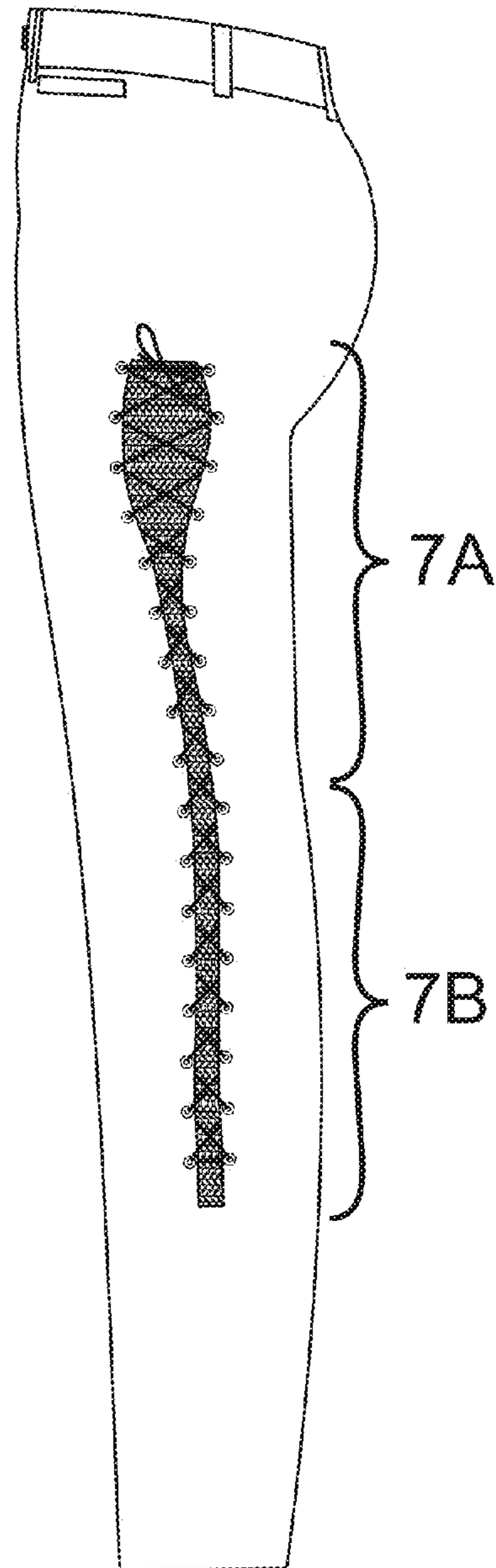

Fig. 4

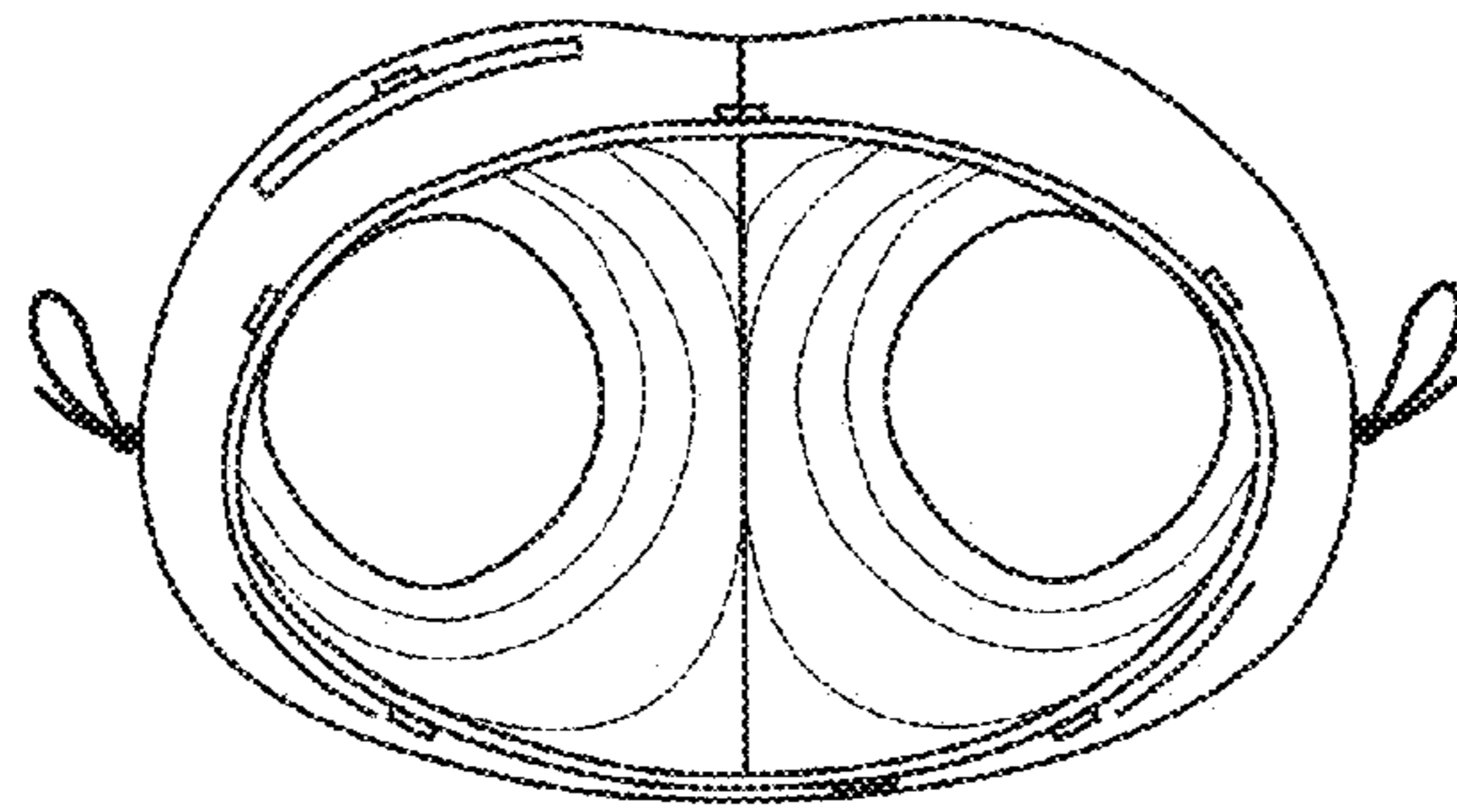

Fig. 5

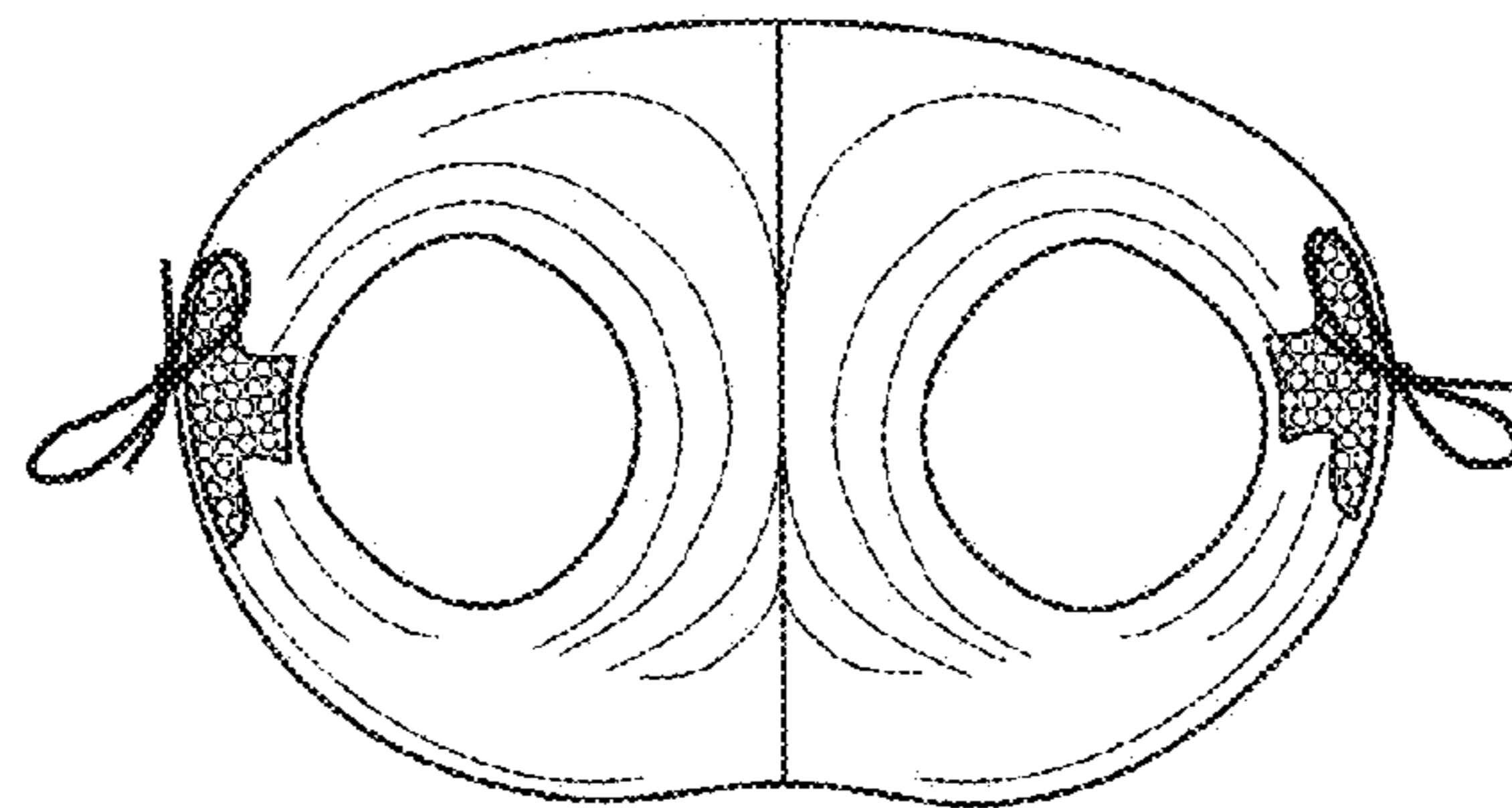

Fig. 6

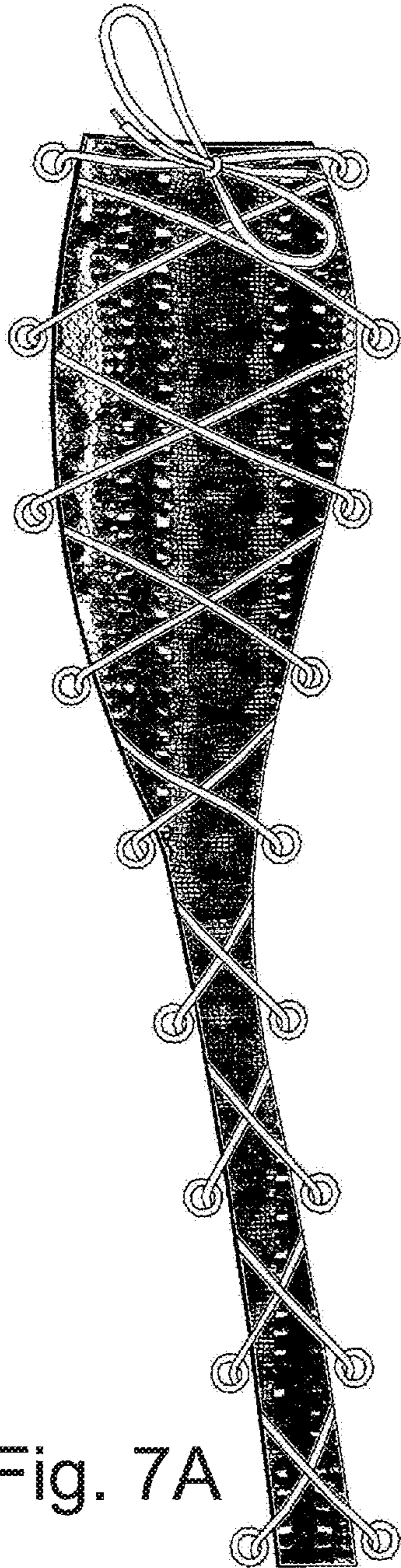

Fig. 7A

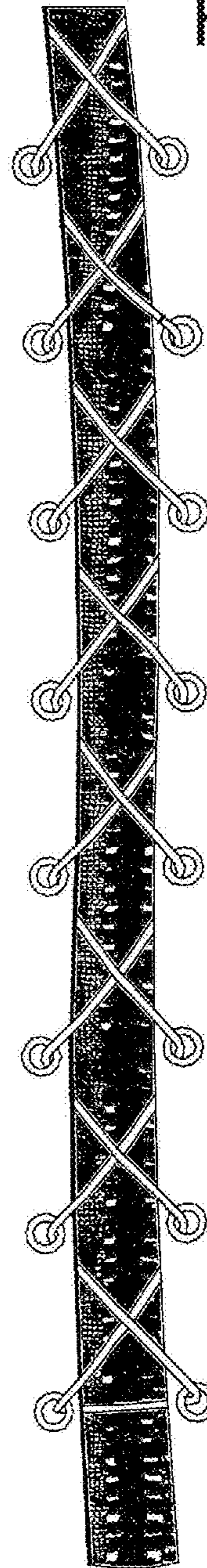

Fig. 7B