



US00D756534S

(12) **United States Design Patent**  
**Allen et al.**

(10) **Patent No.:** **US D756,534 S**

(45) **Date of Patent:** **\*\* May 17, 2016**

(54) **DOOR FACING**

(71) Applicant: **Masonite Corporation**, Tampa, FL (US)

(72) Inventors: **Robert C. Allen**, Elburn, IL (US); **Jason M. Walsh**, Batavia, IL (US); **Dale W. Mayfield**, Tampa, FL (US)

(73) Assignee: **Masonite Corporation**, Tampa, FL (US)

(\*\*) Term: **14 Years**

(21) Appl. No.: **29/516,422**

(22) Filed: **Feb. 2, 2015**

(51) **LOC (10) Cl.** ..... **25-02**

(52) **U.S. Cl.**  
USPC ..... **D25/48.3**

(58) **Field of Classification Search**  
USPC ..... D25/48.3, 48.4, 48.5, 48.6, 48.7, 48.8  
CPC ..... E06B 3/485; E06B 2003/7044; E06B 3/4636; E06B 3/72; E06B 3/78; E06B 1/04; E06B 5/00  
See application file for complete search history.

(56) **References Cited**

**U.S. PATENT DOCUMENTS**

D576,740 S *	9/2008	Steiber	.....	D25/48.3
D585,144 S *	1/2009	Steiber	.....	D25/48.3
D665,099 S *	8/2012	Paxton	.....	D25/48.3
D692,582 S *	10/2013	Paxton	.....	D25/48.3
D735,888 S *	8/2015	Gouge	.....	D25/48.3
D736,409 S *	8/2015	Gouge	.....	D25/48.3
2003/0140587 A1 *	7/2003	Smith	.....	E06B 3/725 52/455

**OTHER PUBLICATIONS**

<http://heritagemillworkinc.com/blog/portfolio-view/primed-doors/>—Published Sep. 15, 2013.\*

\* cited by examiner

*Primary Examiner* — Manpreet Matharu

*Assistant Examiner* — Mojtaba Tehrani

(74) *Attorney, Agent, or Firm* — Berenato & White, LLC

(57) **CLAIM**

The ornamental design for a door facing, as shown and described.

**DESCRIPTION**

FIG. 1 is a front perspective view of our design;  
 FIG. 2 is a front elevational view;  
 FIG. 3 is a rear elevational view;  
 FIG. 4 is a top plan view;  
 FIG. 5 is a bottom plan view;  
 FIG. 6 is a cross sectional view taken along the line 6-6 of FIG. 2 and viewed in the direction of the arrows;  
 FIG. 7 is an enlarged fragmentary cross sectional view taken from FIG. 6;  
 FIG. 8 is a left side plan view;  
 FIG. 9 is a right side plan view;  
 FIG. 10 is a cross sectional view taken along the line 10-10 of FIG. 2 and viewed in the direction of the arrows;  
 FIG. 11 is a perspective view of the second embodiment thereof;  
 FIG. 12 is a front elevational view;  
 FIG. 13 is a rear elevational view;  
 FIG. 14 is a top plan view;  
 FIG. 15 is a bottom plan view;  
 FIG. 16 is a cross sectional view taken along the line 6-6 of FIG. 2 and viewed in the direction of the arrows;  
 FIG. 17 is an enlarged fragmentary cross sectional view taken from FIG. 6;  
 FIG. 18 is a left side plan view;  
 FIG. 19 is a right side plan view; and,  
 FIG. 20 is a cross sectional view taken along the line 10-10 of FIG. 2 and viewed in the direction of the arrows.

**1 Claim, 10 Drawing Sheets**

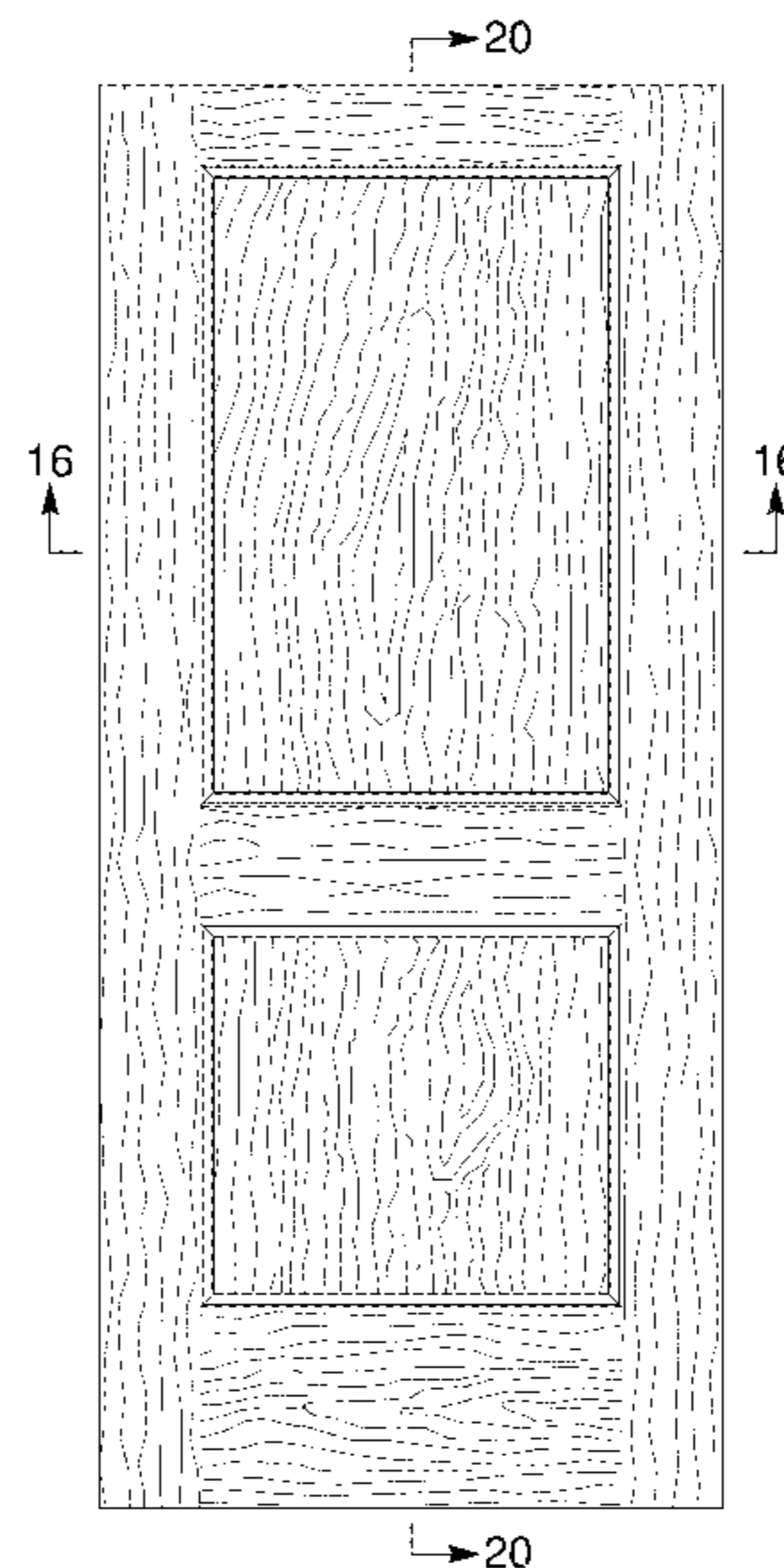
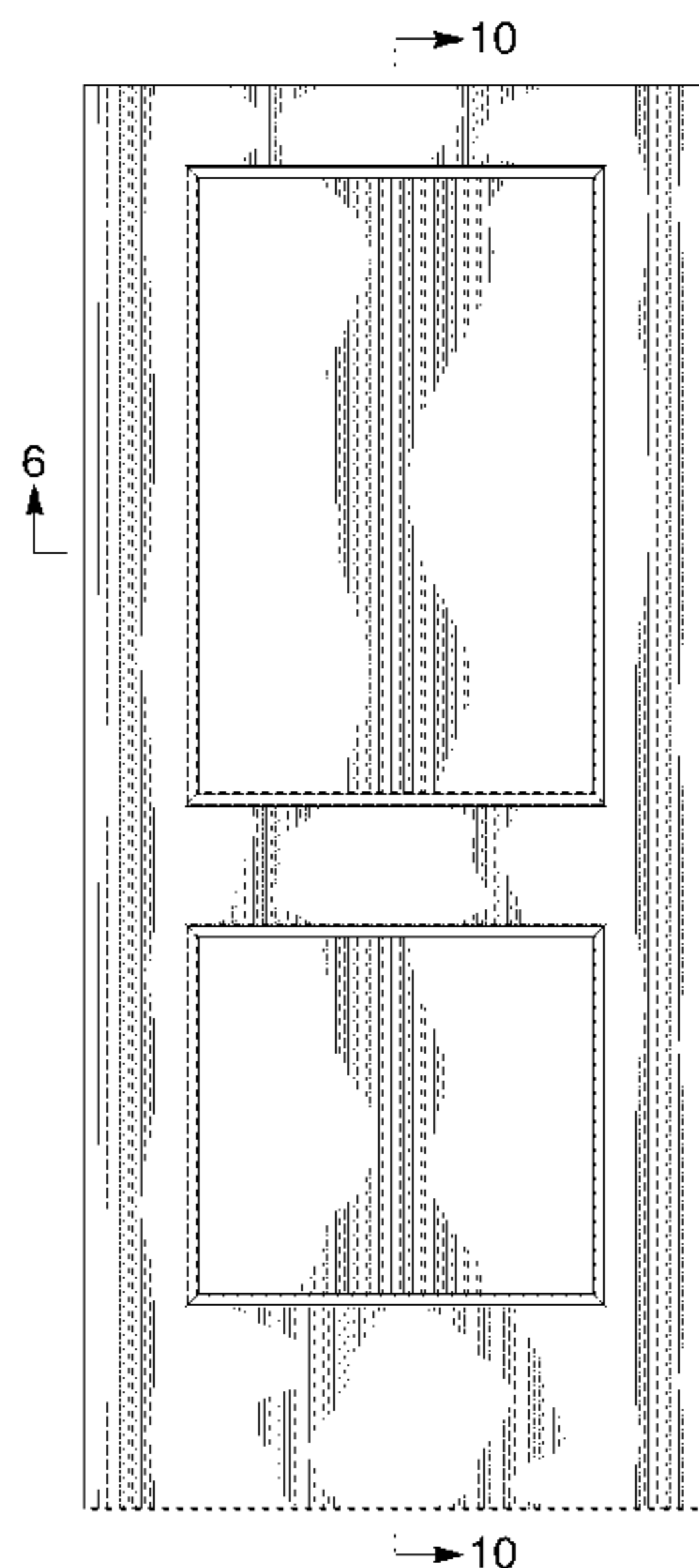

Fig. 1

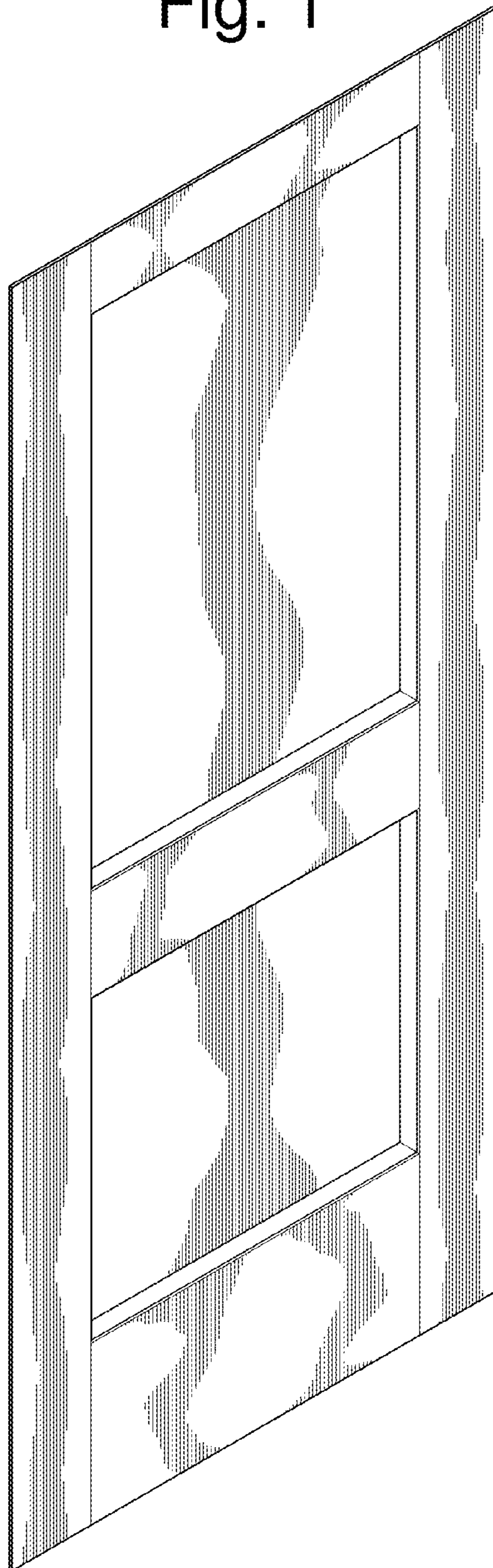

Fig. 2

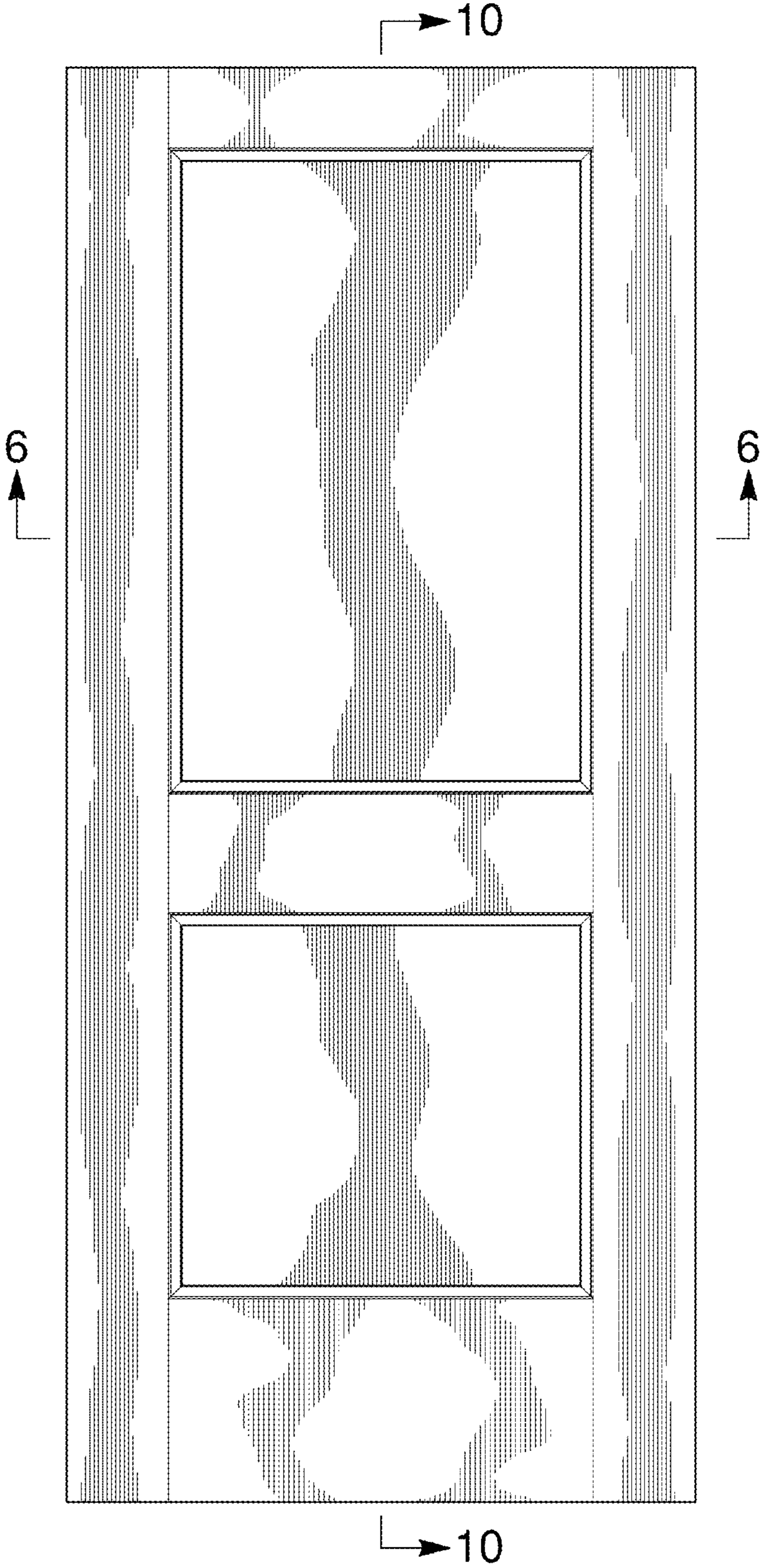

Fig. 3

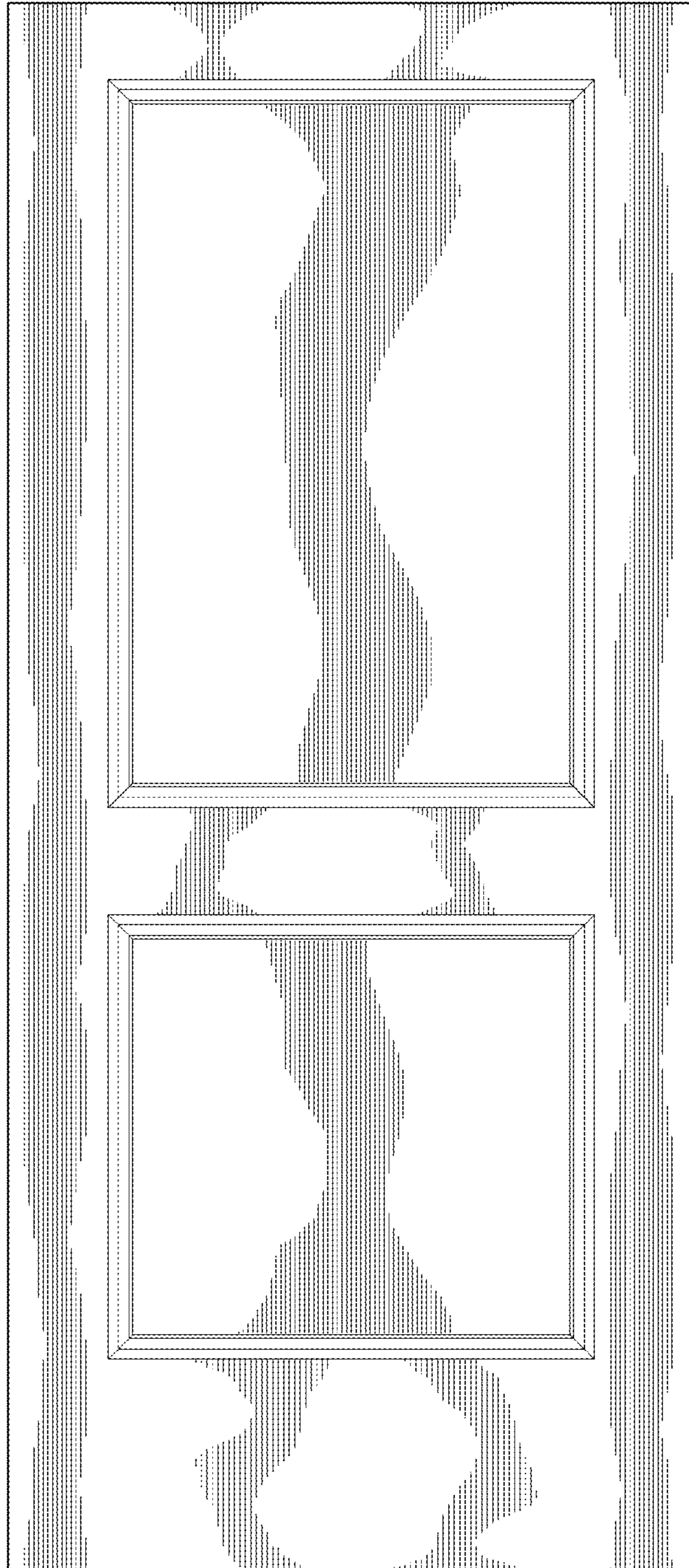

Fig. 4

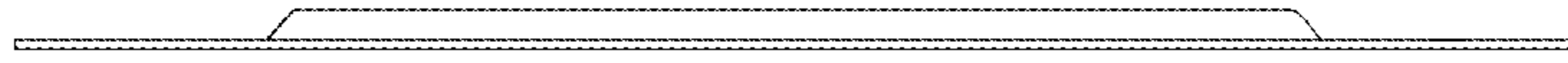

Fig. 5

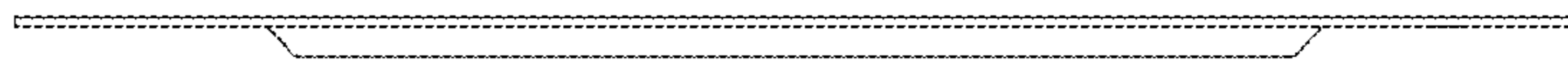

Fig. 6

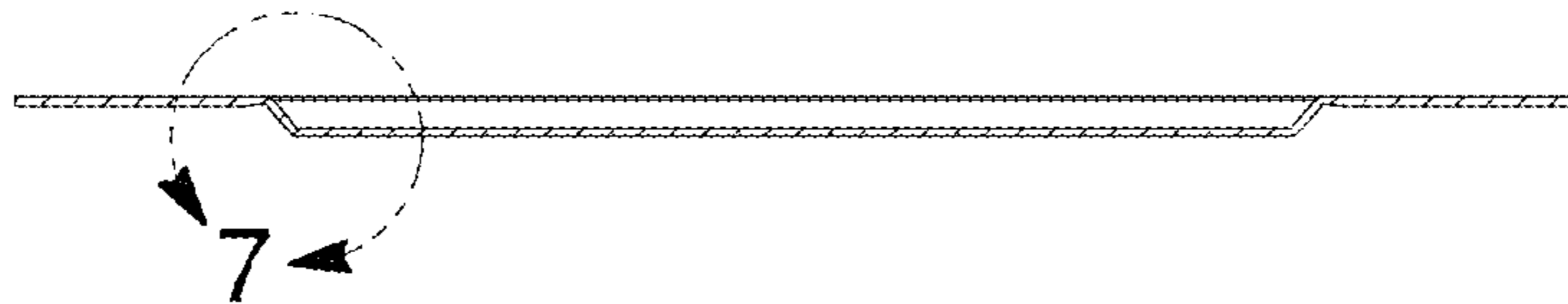

Fig. 7

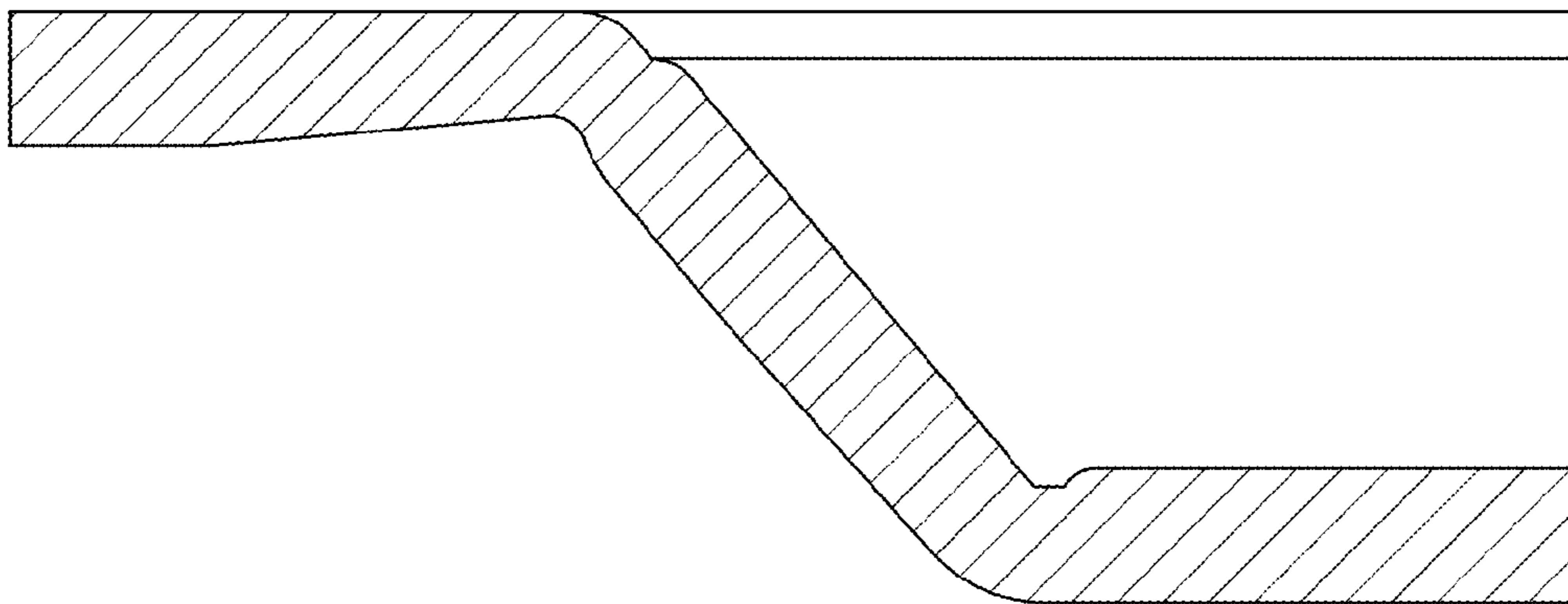

Fig. 8



Fig. 9

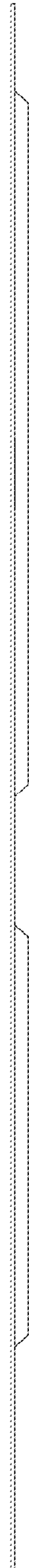

Fig. 10



Fig. 11

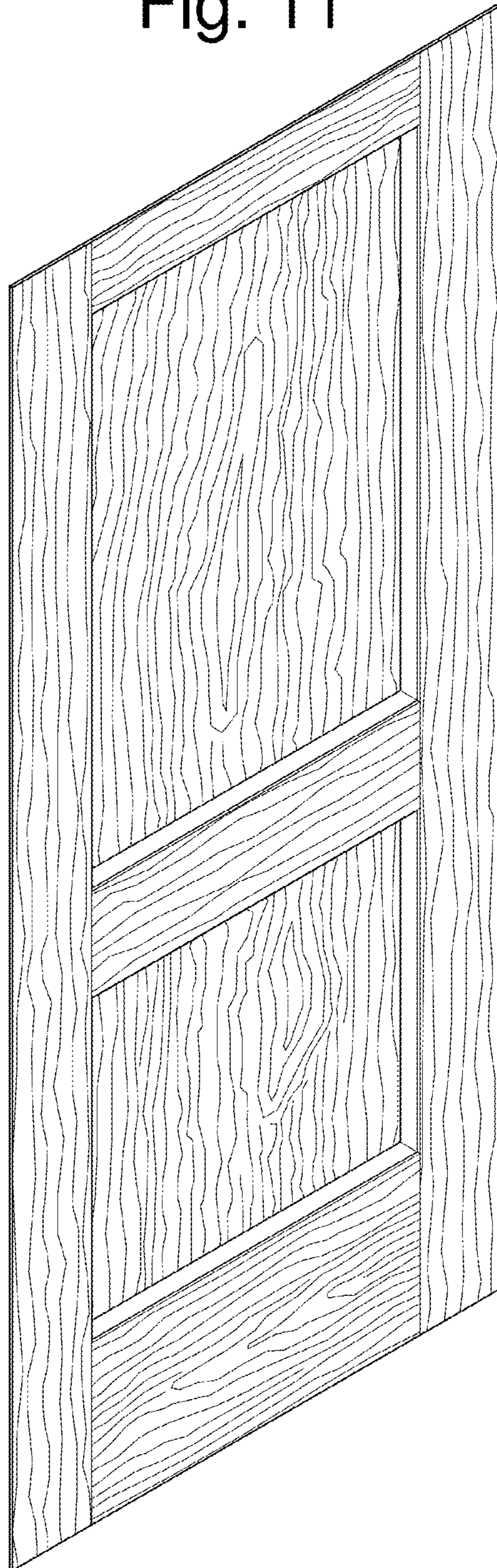

Fig. 12

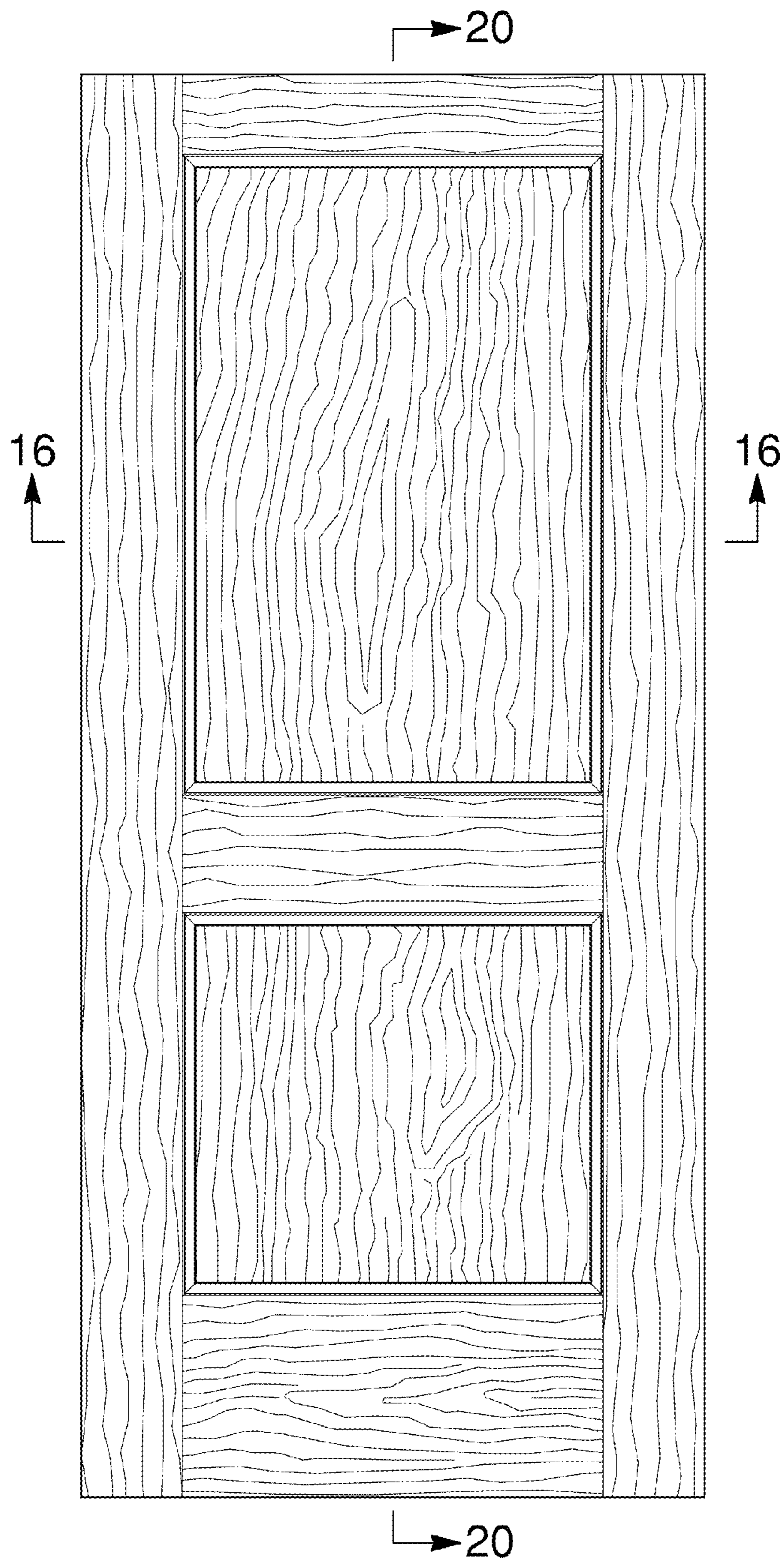



Fig. 13

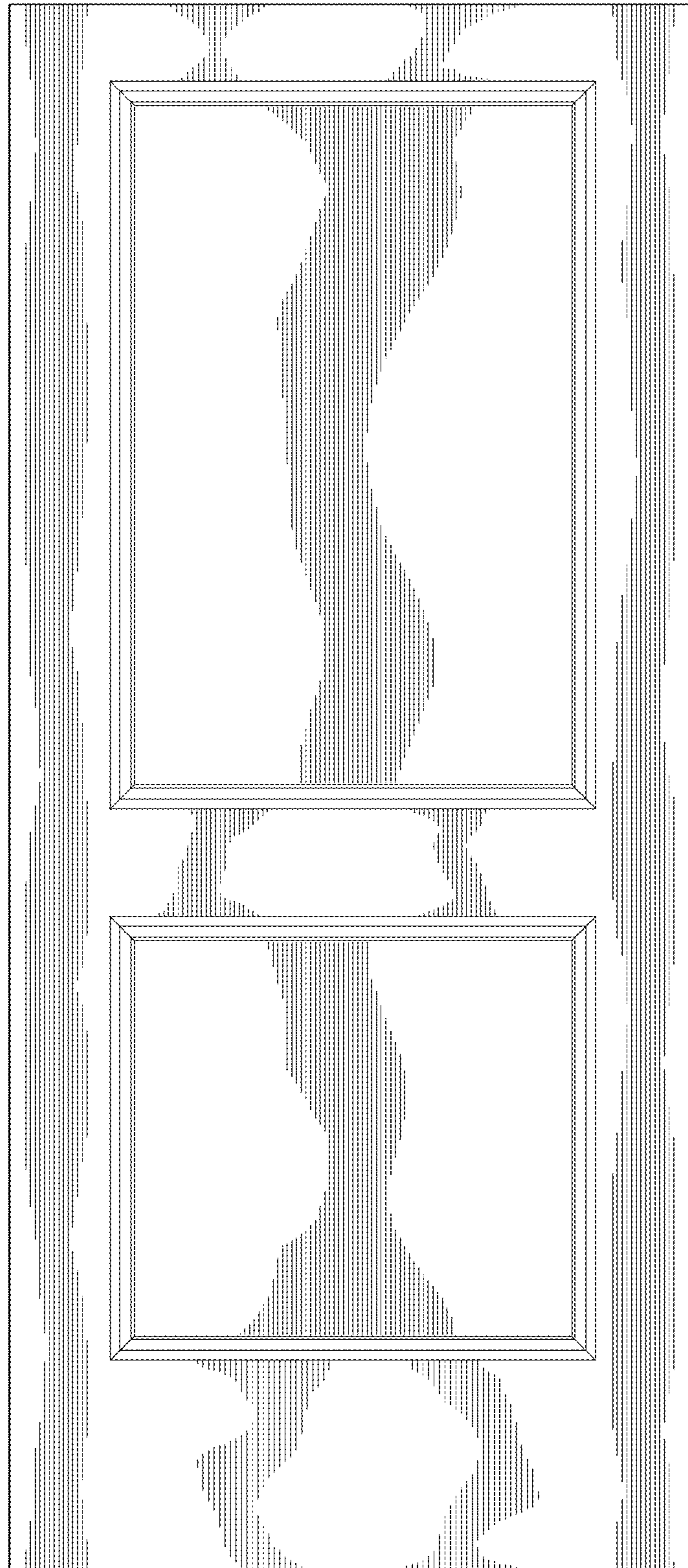

Fig. 14

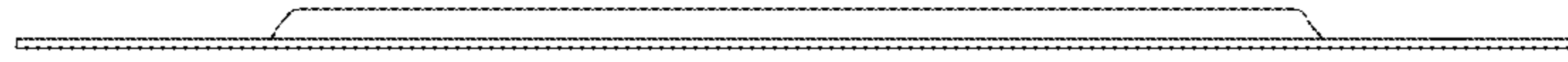

Fig. 15

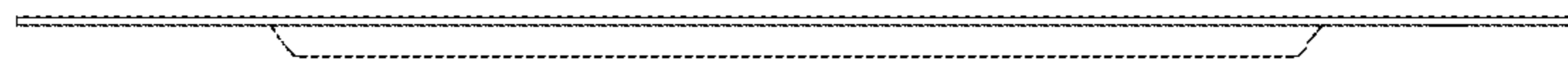

Fig. 16

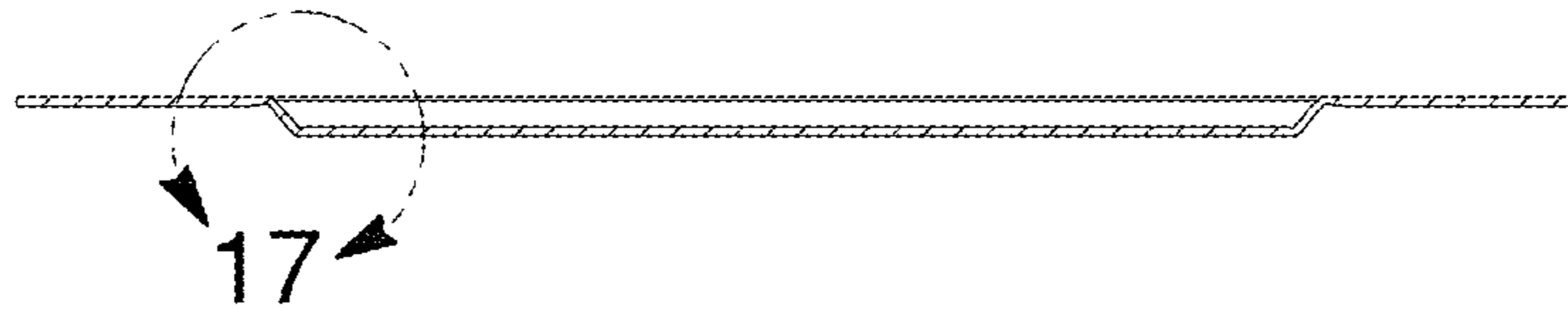

Fig. 17

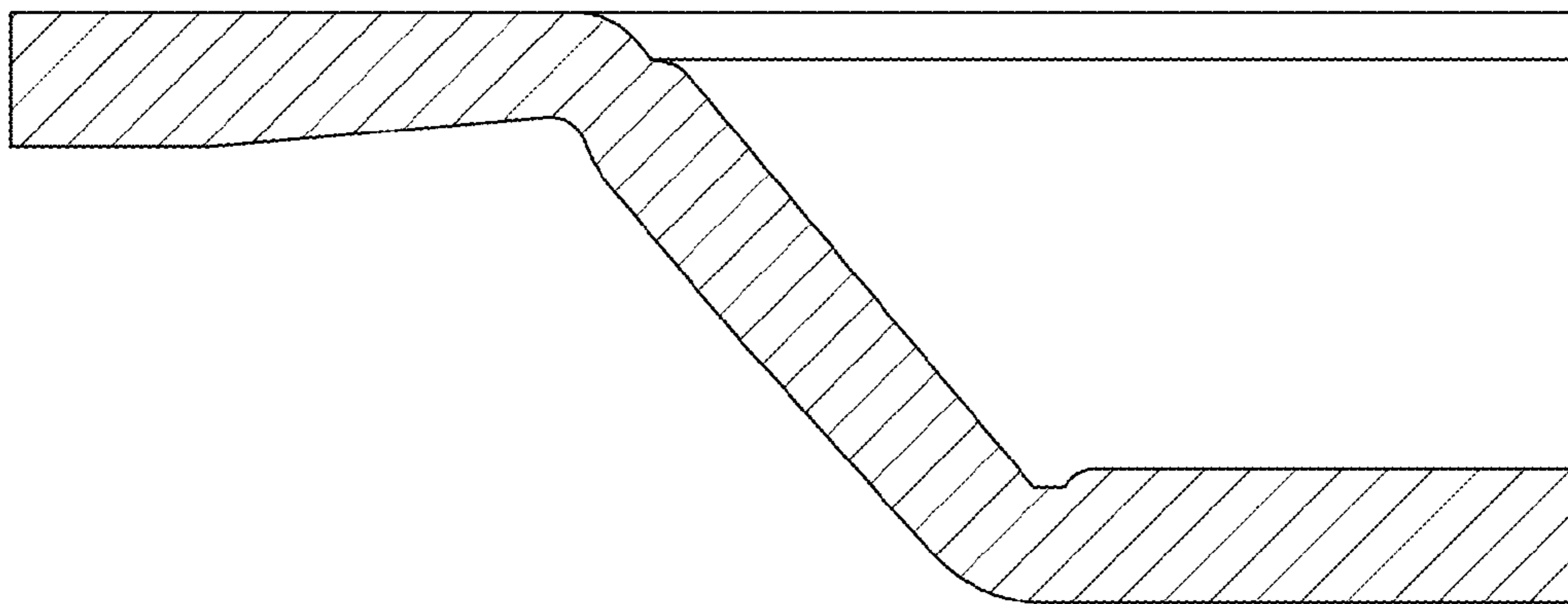

Fig. 18



Fig. 19

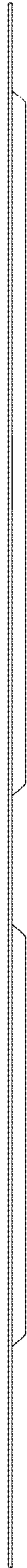

Fig. 20

