



US00D756478S

(12) **United States Design Patent**
Osborne

(10) **Patent No.:** **US D756,478 S**

(45) **Date of Patent:** **** May 17, 2016**

(54) **COLLAPSIBLE PISTOL**

2011/0072705 A1* 3/2011 Simpkins B25F 1/04
42/59

(71) Applicant: **William S. Osborne**, Williamsburg, VA
(US)

2011/0197488 A1 8/2011 Carr
2014/0352190 A1* 12/2014 Voigt F41C 23/14
42/73

(72) Inventor: **William S. Osborne**, Williamsburg, VA
(US)

* cited by examiner

Primary Examiner — Michael A Pratt
(74) *Attorney, Agent, or Firm* — Klarquist Sparkman, LLP

(**) Term: **14 Years**

(57) **CLAIM**
The ornamental design for a collapsible pistol, as shown and described.

(21) Appl. No.: **29/510,491**

DESCRIPTION

(22) Filed: **Nov. 28, 2014**

FIG. 1 is a top view of a collapsible pistol showing my new design, with the pistol configured in an open position;

(51) **LOC (10) Cl.** **22-01**

FIG. 2 is a back view thereof;

(52) **U.S. Cl.**

FIG. 3 is a right side front view thereof;

USPC **D22/104**

FIG. 4 is a front view thereof;

(58) **Field of Classification Search**

USPC D22/104; D21/572–575

FIG. 5 is a bottom view thereof;

CPC F41C 3/14; F41C 3/16; F41C 3/04;

FIG. 6 is a left side view thereof;

F41C 23/04; F41A 11/04

FIG. 7 is a perspective view thereof;

See application file for complete search history.

FIG. 8 is a top view of the collapsible pistol, showing the pistol configured in a collapsed or closed position;

(56) **References Cited**

U.S. PATENT DOCUMENTS

1,454,454 A * 5/1923 Rosier F41A 11/04
42/106

FIG. 9 is a back view of the pistol configuration of FIG. 8;

4,689,908 A 9/1987 McClellan

FIG. 10 is a right side front view of the pistol configuration of FIG. 8;

7,739,821 B1 6/2010 Hamme

FIG. 11 is a front view of the pistol configuration of FIG. 8;

D622,802 S * 8/2010 Fitzpatrick D22/103

FIG. 12 is a bottom view of the pistol configuration of FIG. 8;

2009/0277066 A1* 11/2009 Burt F41A 3/66
42/6

FIG. 13 is a left side view of the pistol configuration of FIG. 8; and,

FIG. 14 is a perspective view of the pistol configuration of FIG. 8.

1 Claim, 2 Drawing Sheets

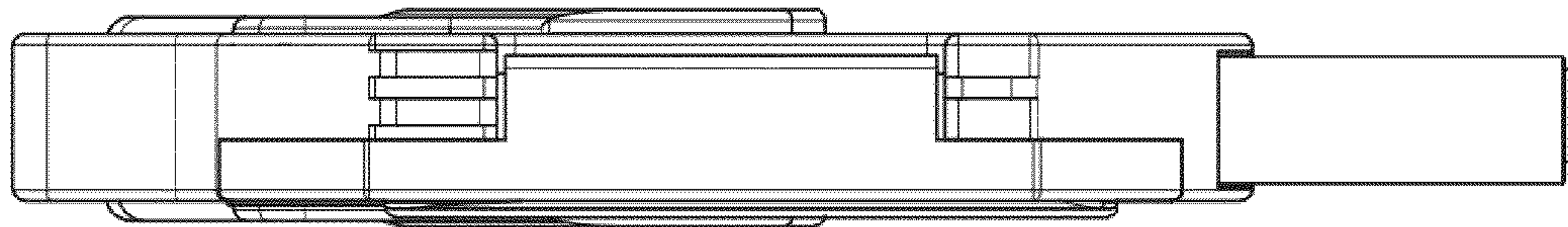

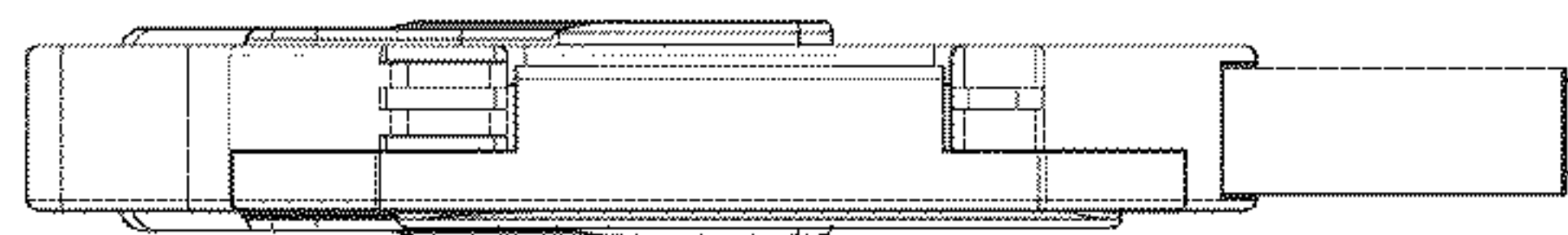

FIG. 1

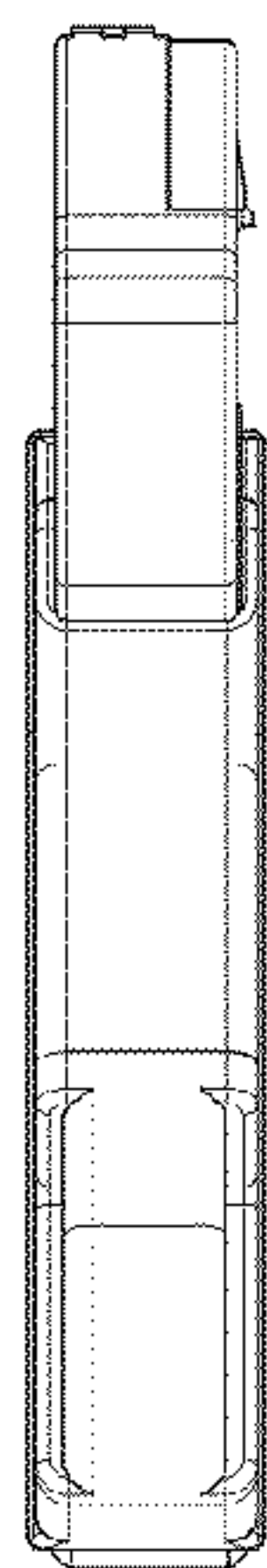

FIG. 2

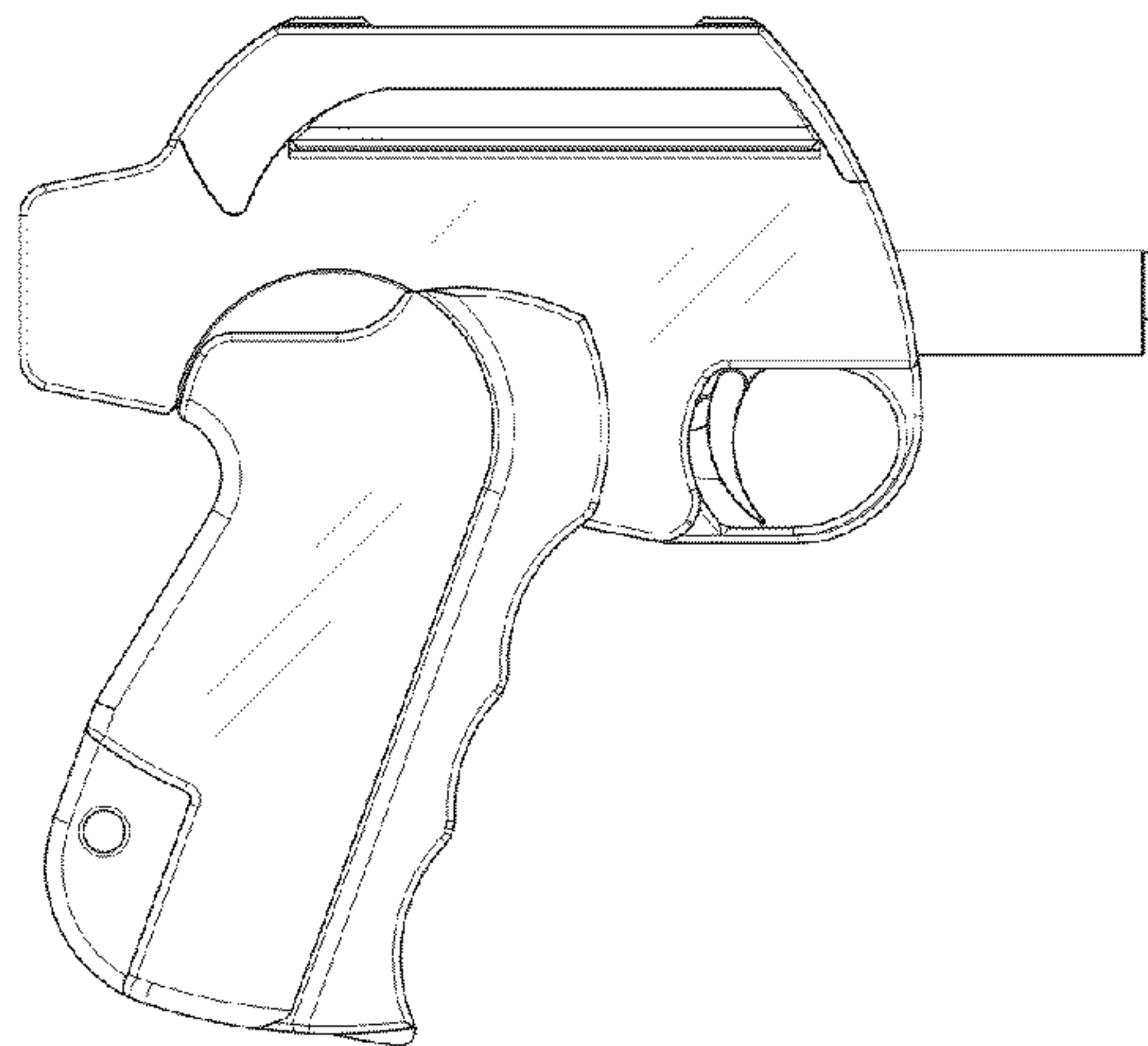

FIG. 3

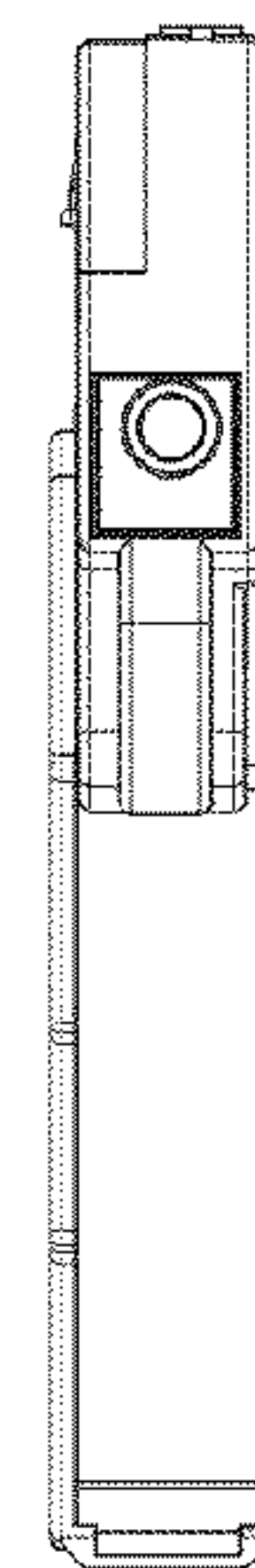

FIG. 4

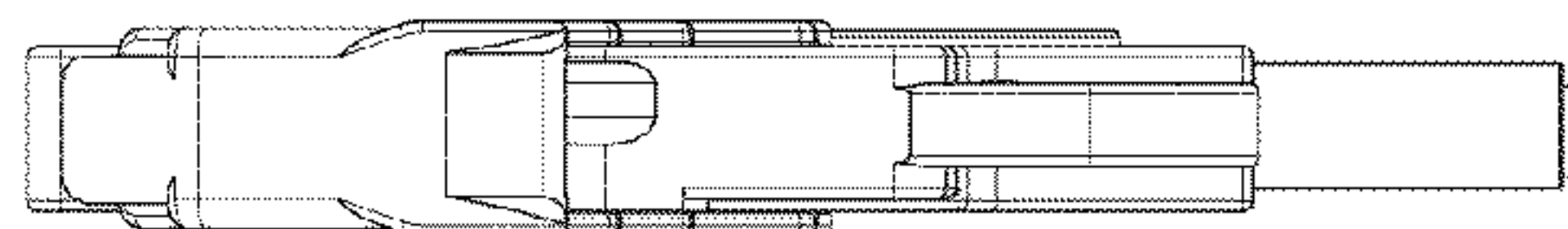

FIG. 5

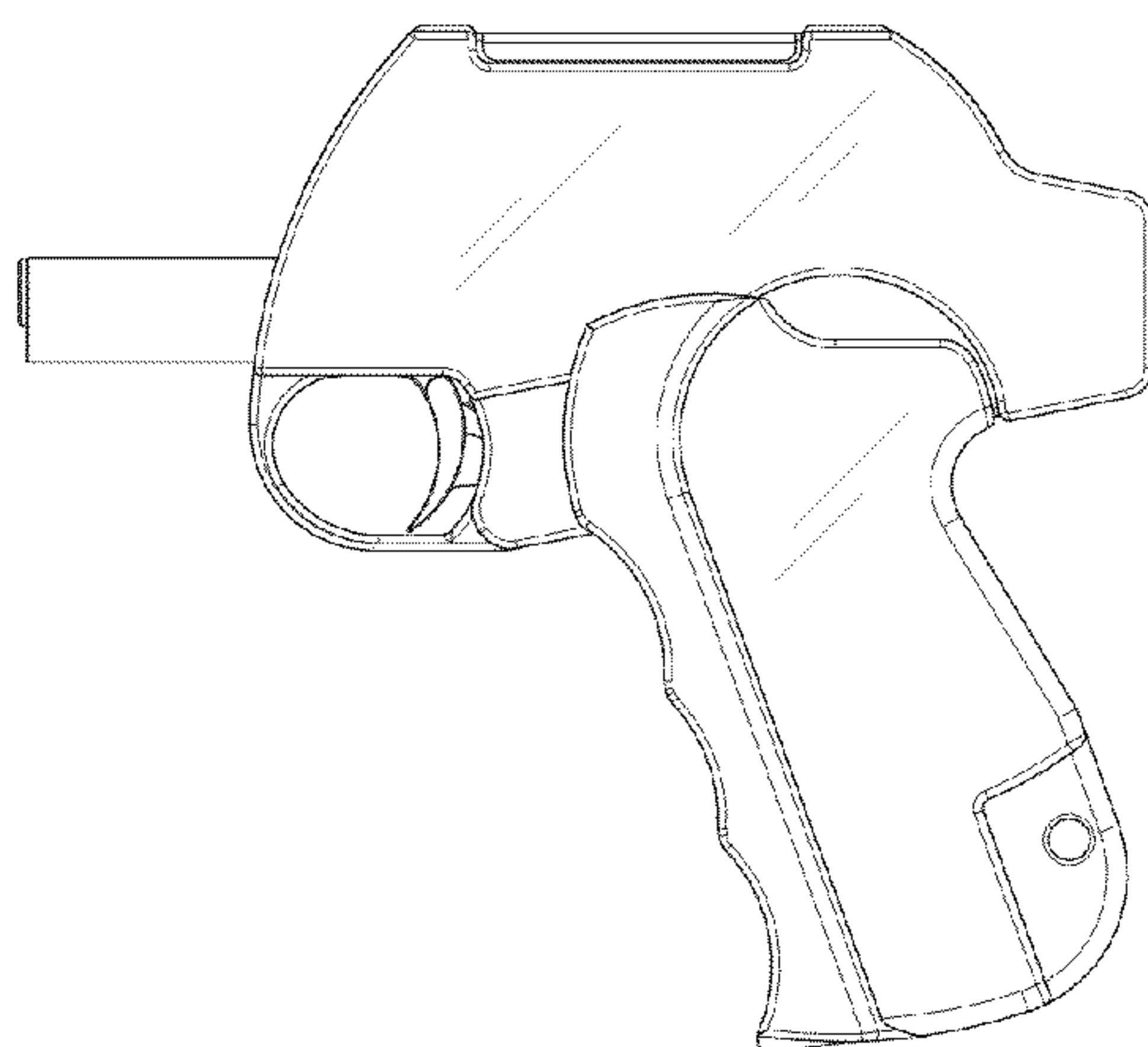

FIG. 6

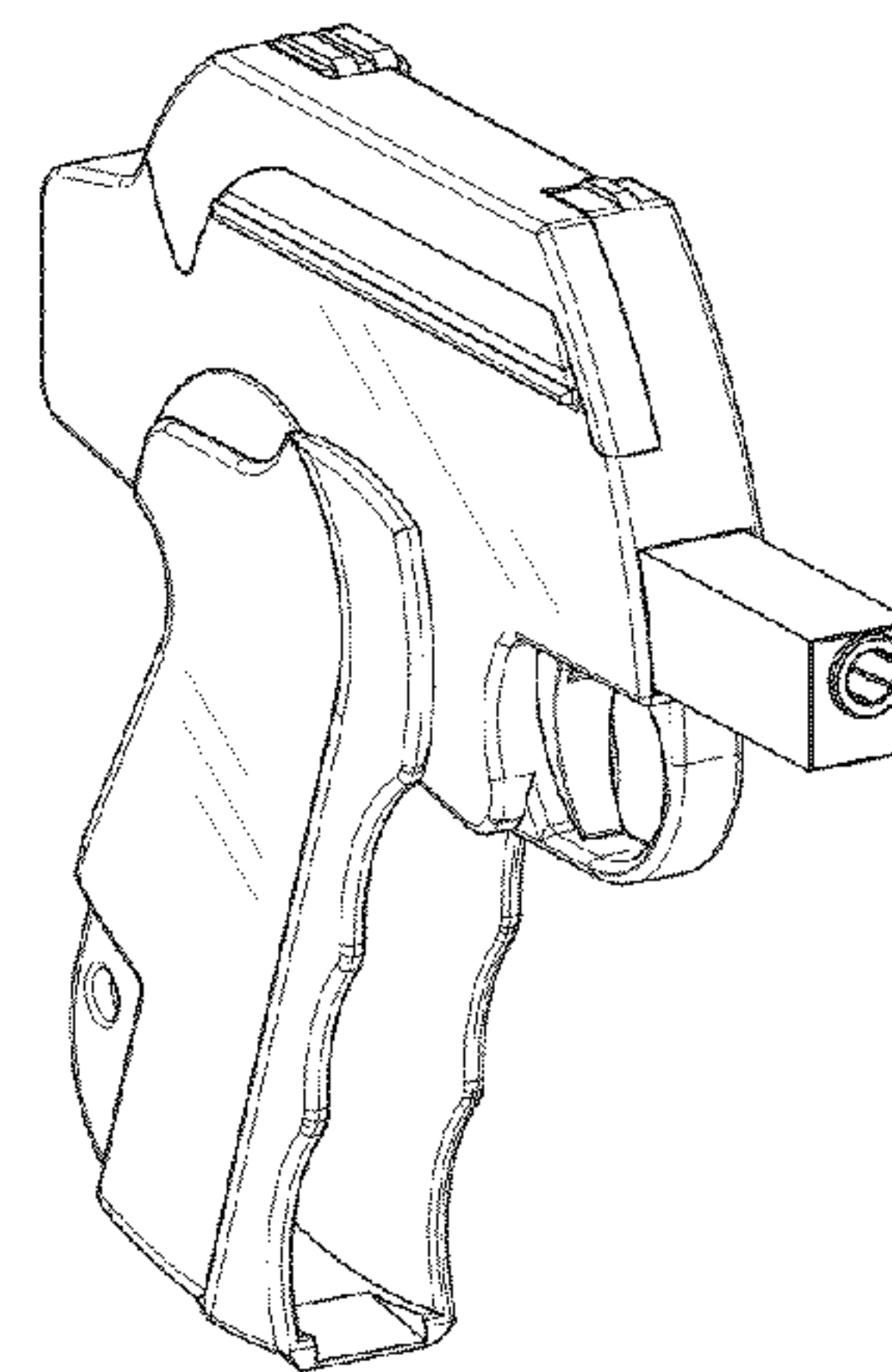

FIG. 7



FIG. 8

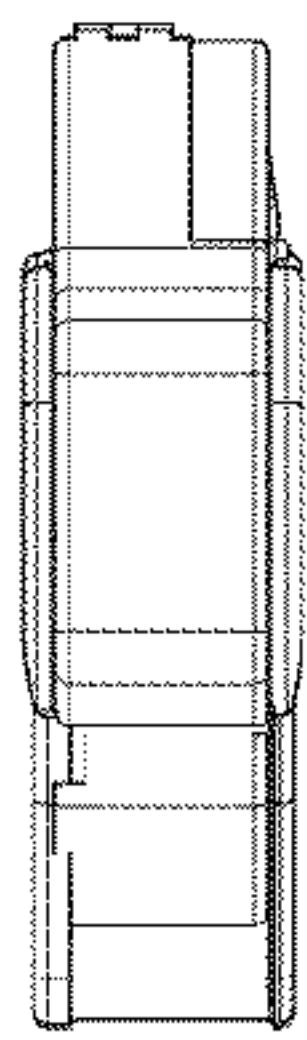

FIG. 9

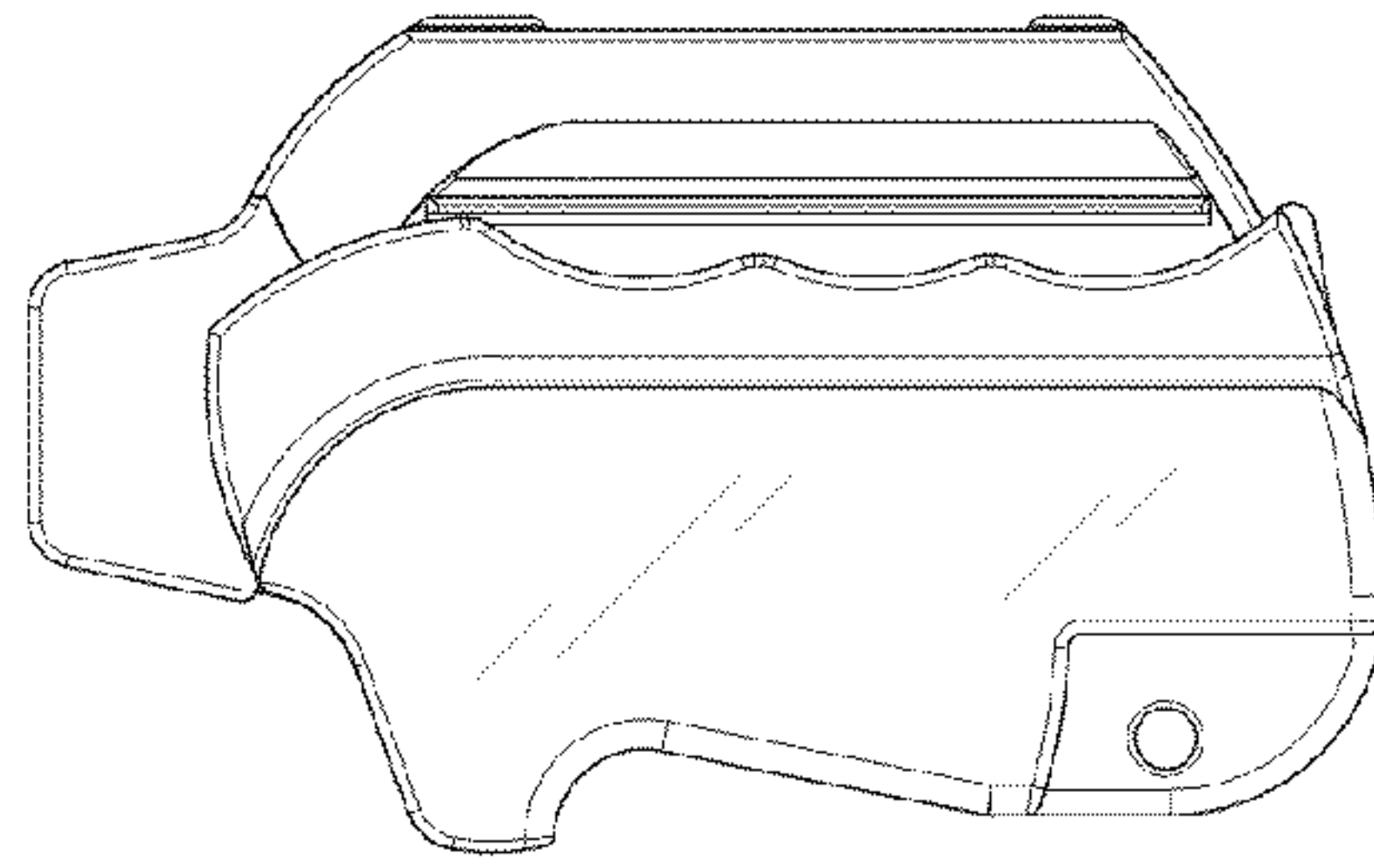

FIG. 10

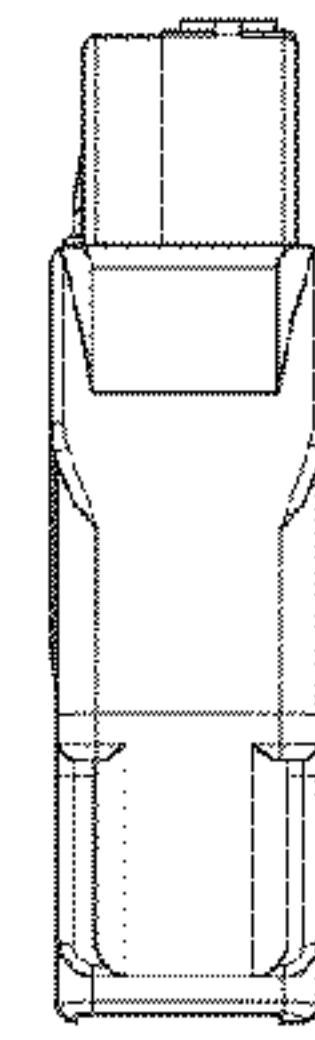

FIG. 11

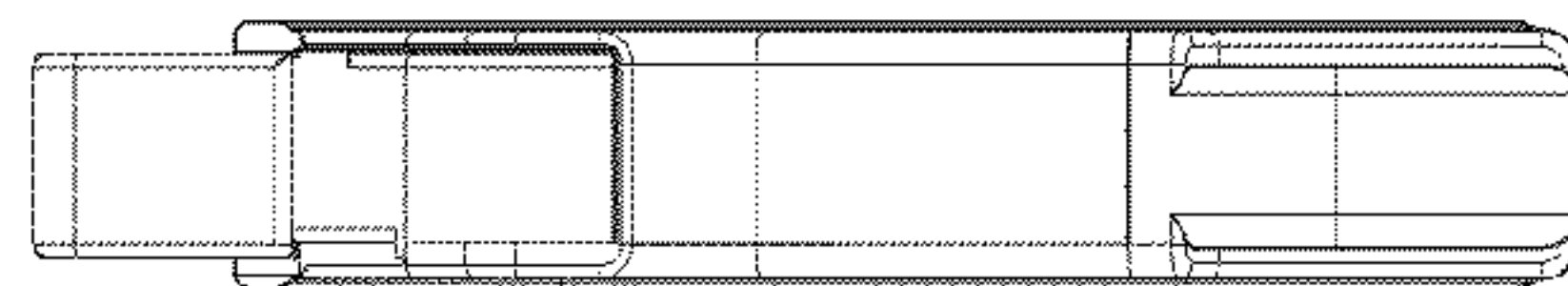

FIG. 12

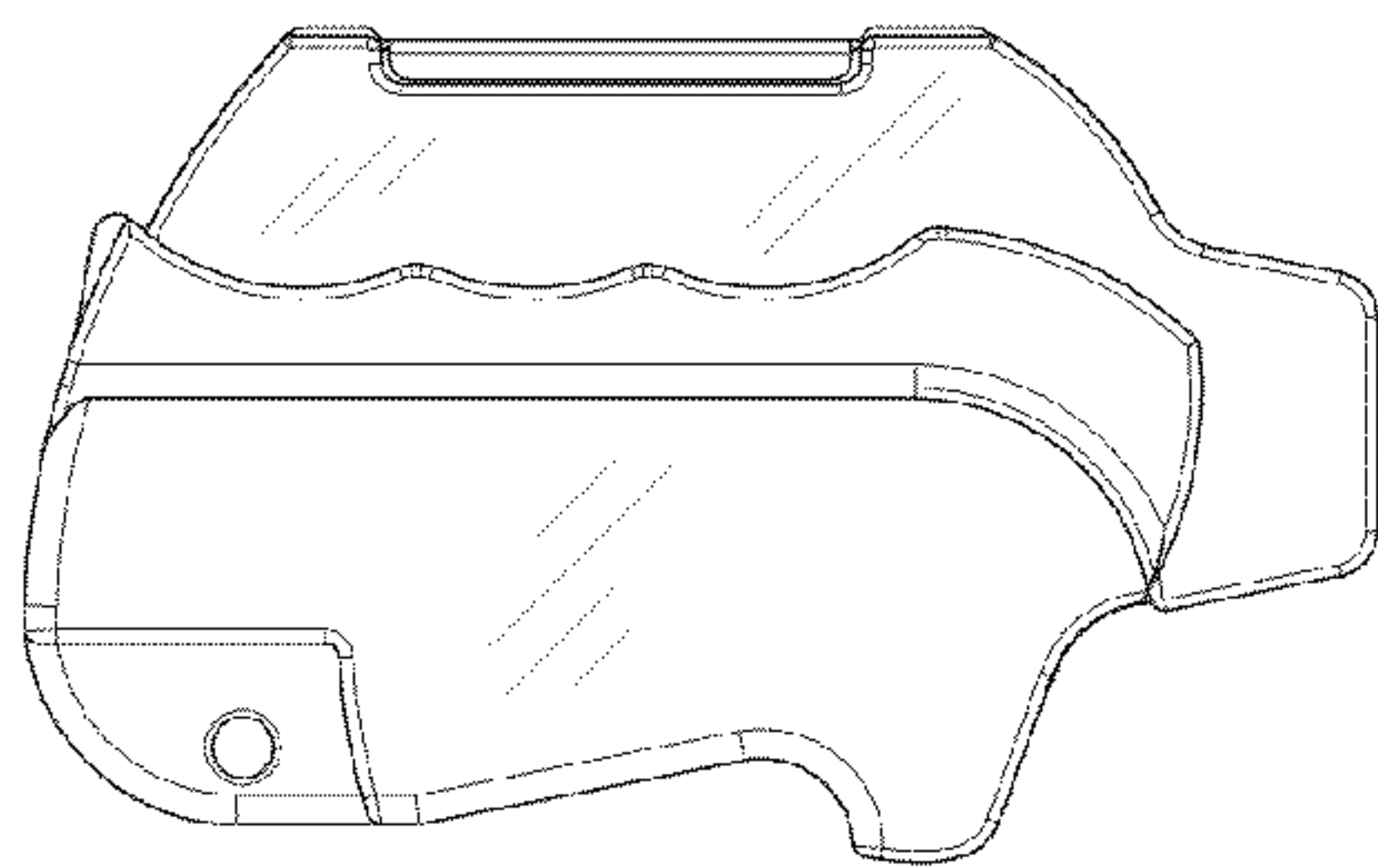

FIG. 13

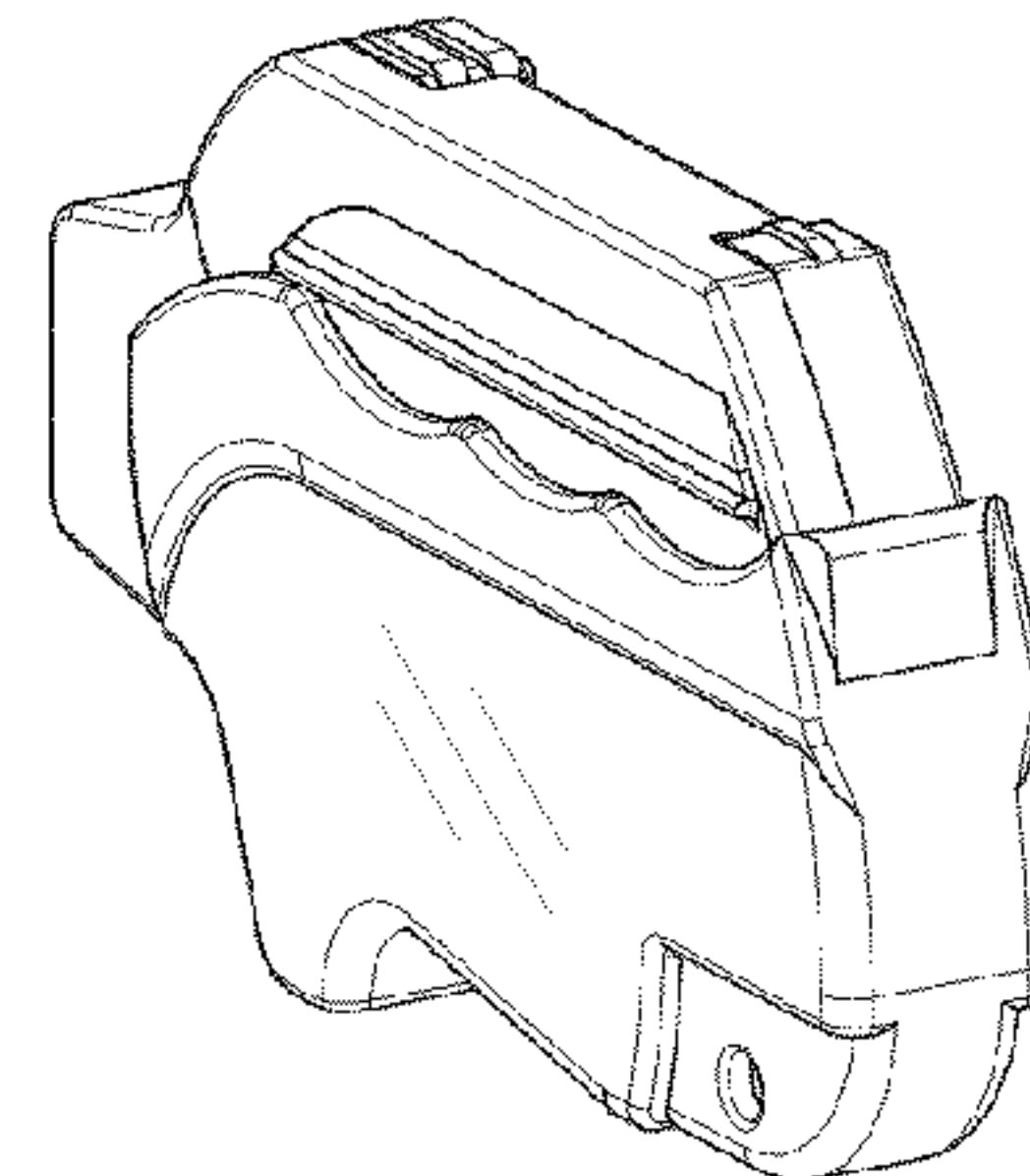

FIG. 14