



US00D756459S

(12) **United States Design Patent**
deWeber

(10) **Patent No.:** **US D756,459 S**
(45) **Date of Patent:** **** May 17, 2016**

(54) **EASEL**
(71) Applicant: **deWeber Studios**, Woodland, WA (US)
(72) Inventor: **Jennifer deWeber**, Woodland, WA (US)
(73) Assignee: **deWeber Studios**, Woodland, WA (US)
(**) Term: **15 Years**
(21) Appl. No.: **29/540,274**
(22) Filed: **Sep. 22, 2015**
(51) **LOC (10) Cl.** **19-06**
(52) **U.S. Cl.**
USPC **D19/106**
(58) **Field of Classification Search**
USPC D19/106, 102; 1/1; 248/460; 260/756;
206/1.8; 213/231
See application file for complete search history.

(56) **References Cited**
U.S. PATENT DOCUMENTS

815,810 A 3/1906 Goldsworthy et al.
2,586,524 A 2/1952 Dussardier

(Continued)
OTHER PUBLICATIONS
Stutler, Russell, "Russell Stutler's Book About Sketching," at least as early as Jul. 27, 2015, http://www.stutler.cc/other/sketchbook/sketchbook_c_04.html, 13 pages.
(Continued)

Primary Examiner — Cynthia Underwood
(74) *Attorney, Agent, or Firm* — Law Office of Karen Dana Oster, LLC

(57) **CLAIM**
I claim the ornamental design for an easel, as shown and described.

DESCRIPTION

FIG. 1 is a front perspective view of a third preferred easel shown in a folded closed configuration.

FIG. 2 is a back perspective of the easel of FIG. 1.
FIG. 3 is a top view of the easel of FIG. 1.
FIG. 4 is a bottom view of the easel of FIG. 1.
FIG. 5 is a front view of the easel of FIG. 1.
FIG. 6 is a back view of the easel of FIG. 1.
FIG. 7 is a first side view of the easel of FIG. 1.
FIG. 8 is a second side view of the easel of FIG. 1.
FIG. 9 is a front perspective view of the third preferred easel in a first open configuration with the painting compartment substantially parallel to the palette compartment.
FIG. 10 is a back perspective of the easel of FIG. 9.
FIG. 11 is a top view of the easel of FIG. 9.
FIG. 12 is a bottom view of the easel of FIG. 9.
FIG. 13 is a front view of the easel of FIG. 9.
FIG. 14 is a back view of the easel of FIG. 9.
FIG. 15 is a first side view of the easel of FIG. 9.
FIG. 16 is a second side view of the easel of FIG. 9.
FIG. 17 is a front perspective view of the third preferred easel in a second open configuration with an inner cover of the palette compartment open.
FIG. 18 is a back perspective of the easel of FIG. 17.
FIG. 19 is a top view of the easel of FIG. 17.
FIG. 20 is a bottom view of the easel of FIG. 17.
FIG. 21 is a front view of the easel of FIG. 17.
FIG. 22 is a back view of the easel of FIG. 17.
FIG. 23 is a first side view of the easel of FIG. 17.
FIG. 24 is a second side view of the easel of FIG. 17.
FIG. 25 is a front perspective view of the third preferred easel in a third open configuration with an inner cover of the palette compartment wrapped over the back of the palette compartment.
FIG. 26 is a back perspective of the easel of FIG. 25.
FIG. 27 is a top view of the easel of FIG. 25.
FIG. 28 is a bottom view of the easel of FIG. 25.
FIG. 29 is a front view of the easel of FIG. 25.
FIG. 30 is a back view of the easel of FIG. 25.
FIG. 31 is a first side view of the easel of FIG. 25; and,
FIG. 32 is a second side view of the easel of FIG. 25.
The easel is shown with symbolic breaks in its length and width. These symbols indicate that any portion of the article beyond what is shown forms no part of the claim.

1 Claim, 22 Drawing Sheets

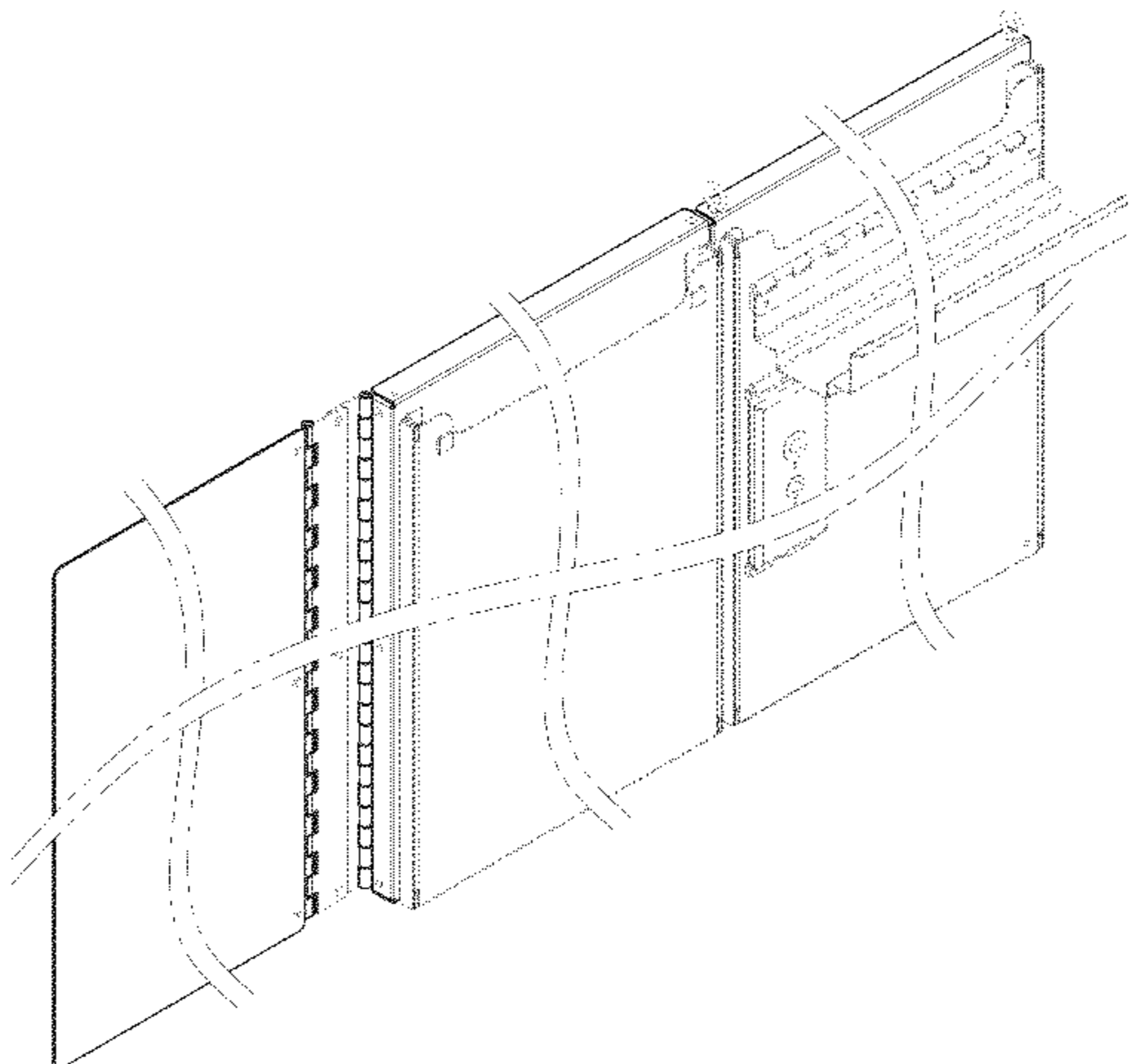

(56)

References Cited

U.S. PATENT DOCUMENTS

2,693,258 A 11/1954 Fleisch
 2,751,271 A 6/1956 Dessertenne et al.
 4,093,326 A * 6/1978 Ford A47B 97/08
 248/461
 4,335,812 A 6/1982 Koves
 4,372,630 A * 2/1983 Fuhri A47B 97/08
 206/1.7
 4,662,518 A * 5/1987 Chiappetta A63F 3/068
 206/230
 4,856,856 A 8/1989 Winstone
 5,348,144 A 9/1994 Maier
 D424,296 S * 5/2000 David D3/273
 6,296,213 B1 * 10/2001 Law, III G10G 5/00
 206/45.2
 6,745,988 B2 * 6/2004 Gelfand A47B 97/04
 248/460
 6,748,873 B2 6/2004 Brown, Sr.
 7,188,818 B2 3/2007 Chang

7,694,806 B2 * 4/2010 Huggins B44D 3/04
 206/1.7
 D649,040 S * 11/2011 Sanders D9/432
 D653,854 S * 2/2012 Chamberlain D3/294
 D687,096 S * 7/2013 Taylor D19/106
 D701,699 S * 4/2014 Bonacina D3/304
 9,102,192 B2 8/2015 Taylor

OTHER PUBLICATIONS

amazon.com, "Zen Art Supply Desktop Artist Easel Wooden Portable Stand Student Painting," at least as early as Jul. 27, 2015, <http://www.amazon.com>, 6 pages.
 amazon.com, "Sienna Plein Air Artist Pochade Box Easel Large," at least as early as Jul. 27, 2015, <http://www.amazon.com>, 4 pages.
 amazon.com, "Saunders Recycled Aluminum Snapak Form Holder, Letter Size, 9x12-inches (10517) : Clipboards : Office Products," at least as early as Jul. 31, 2015, <http://www.amazon.com>, 7 pages.
 Strada Designs, "Strada Easel," www.stradaeasel.com/pages/strada, at least as early as Sep. 22, 2015, 3 pages.

* cited by examiner

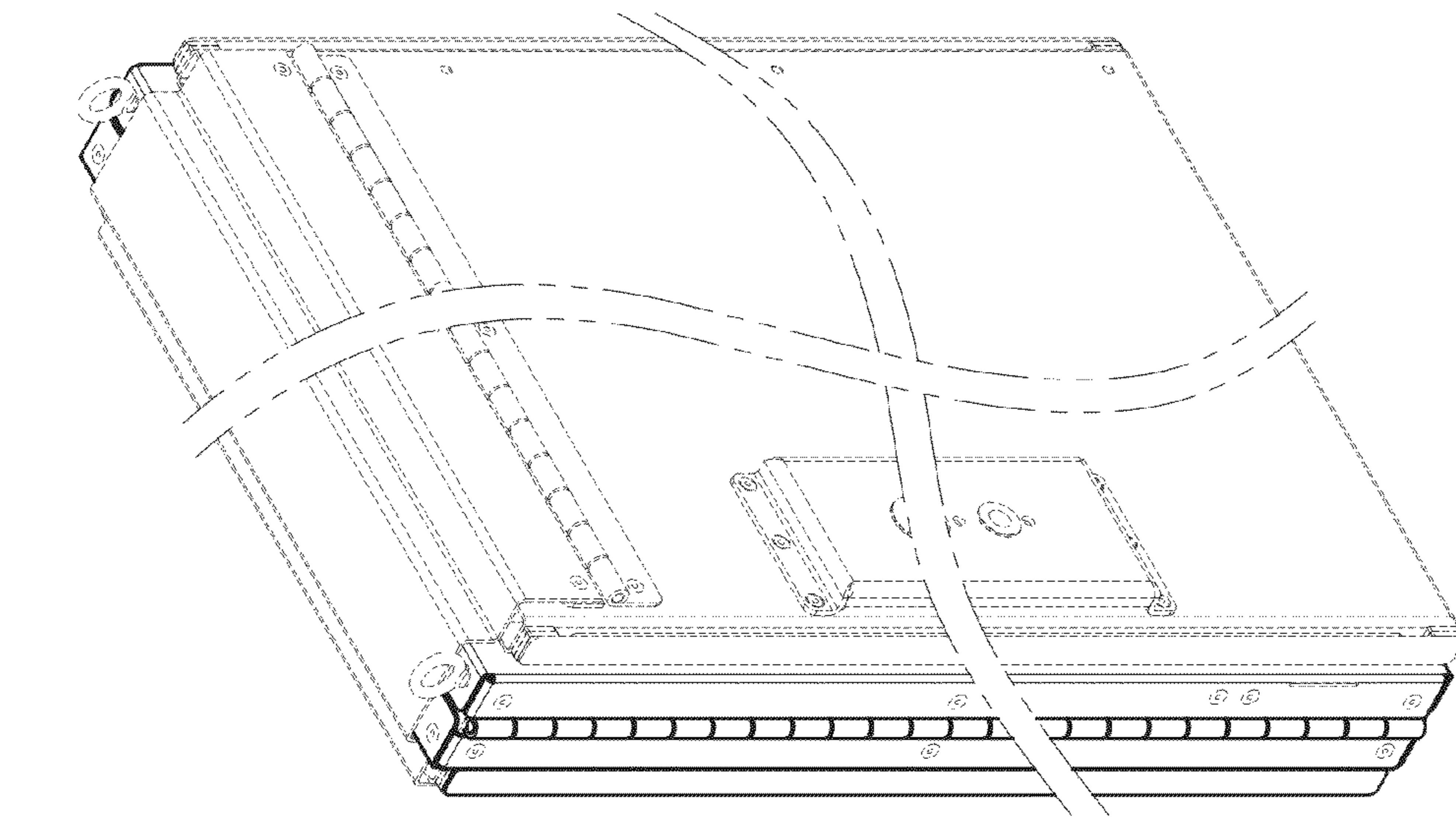

FIG. 1

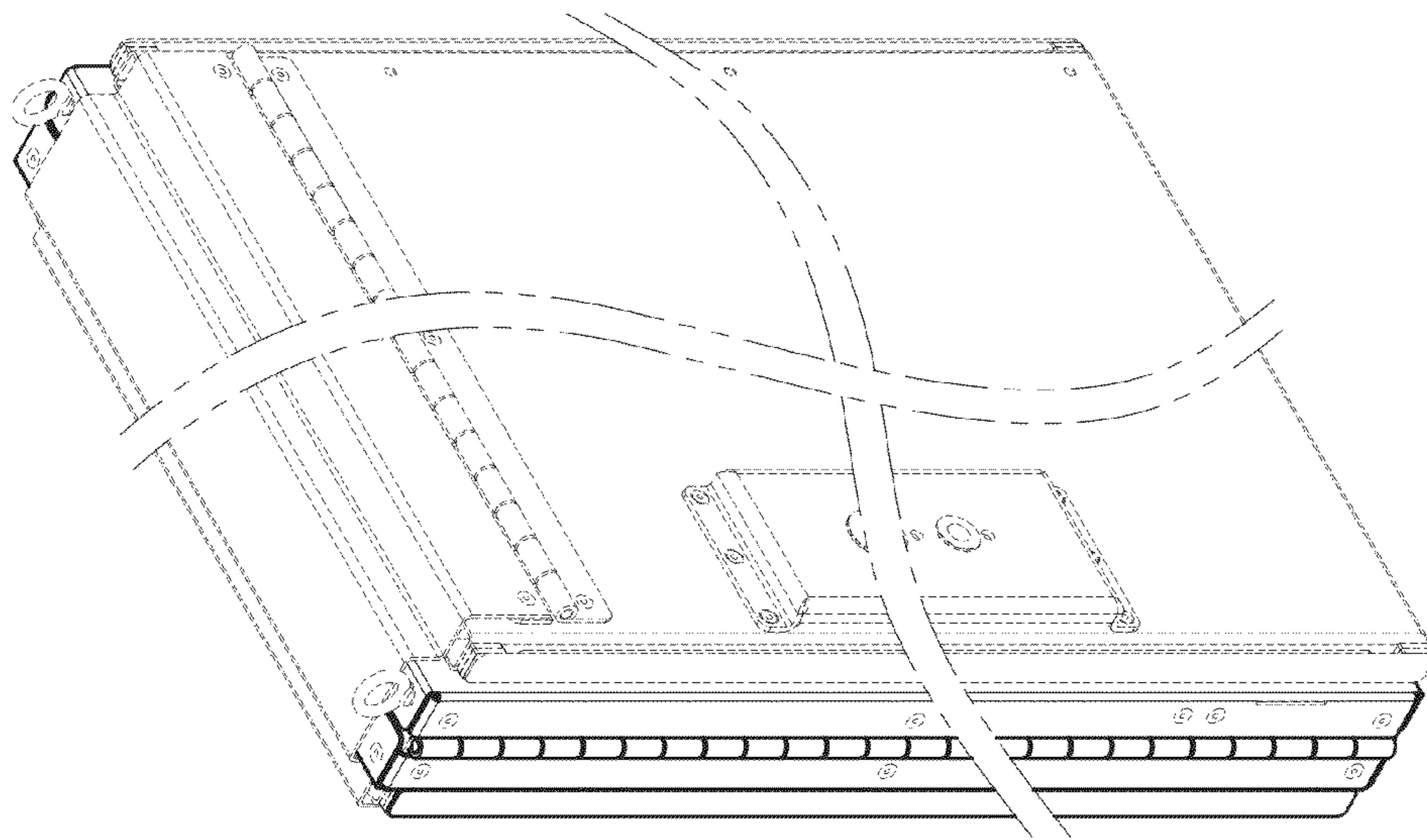

FIG. 2

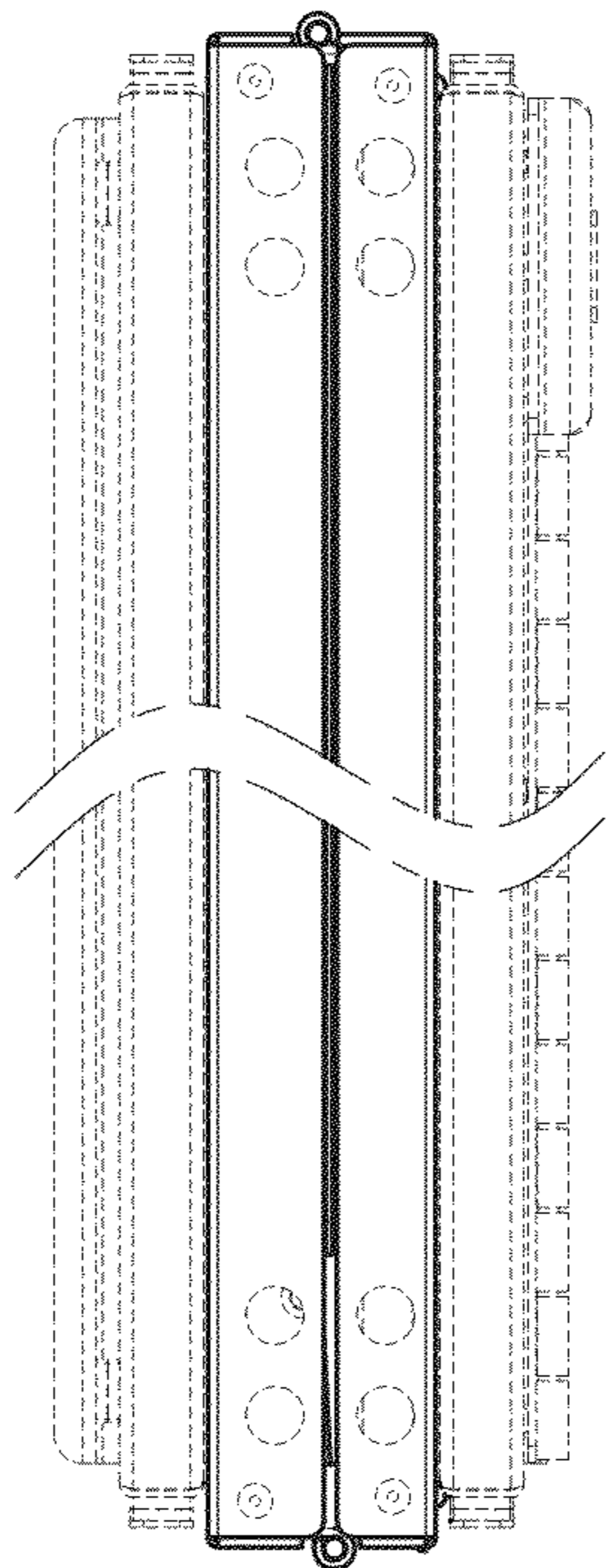

FIG. 4

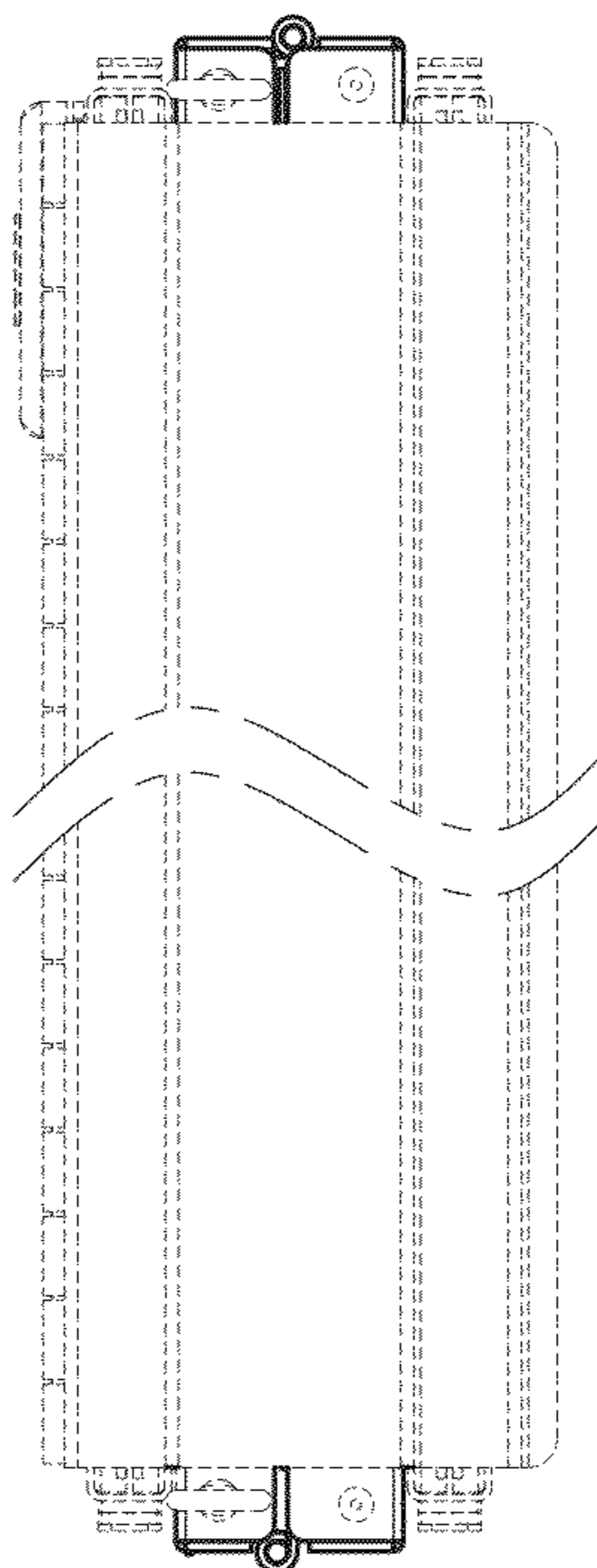

FIG. 3

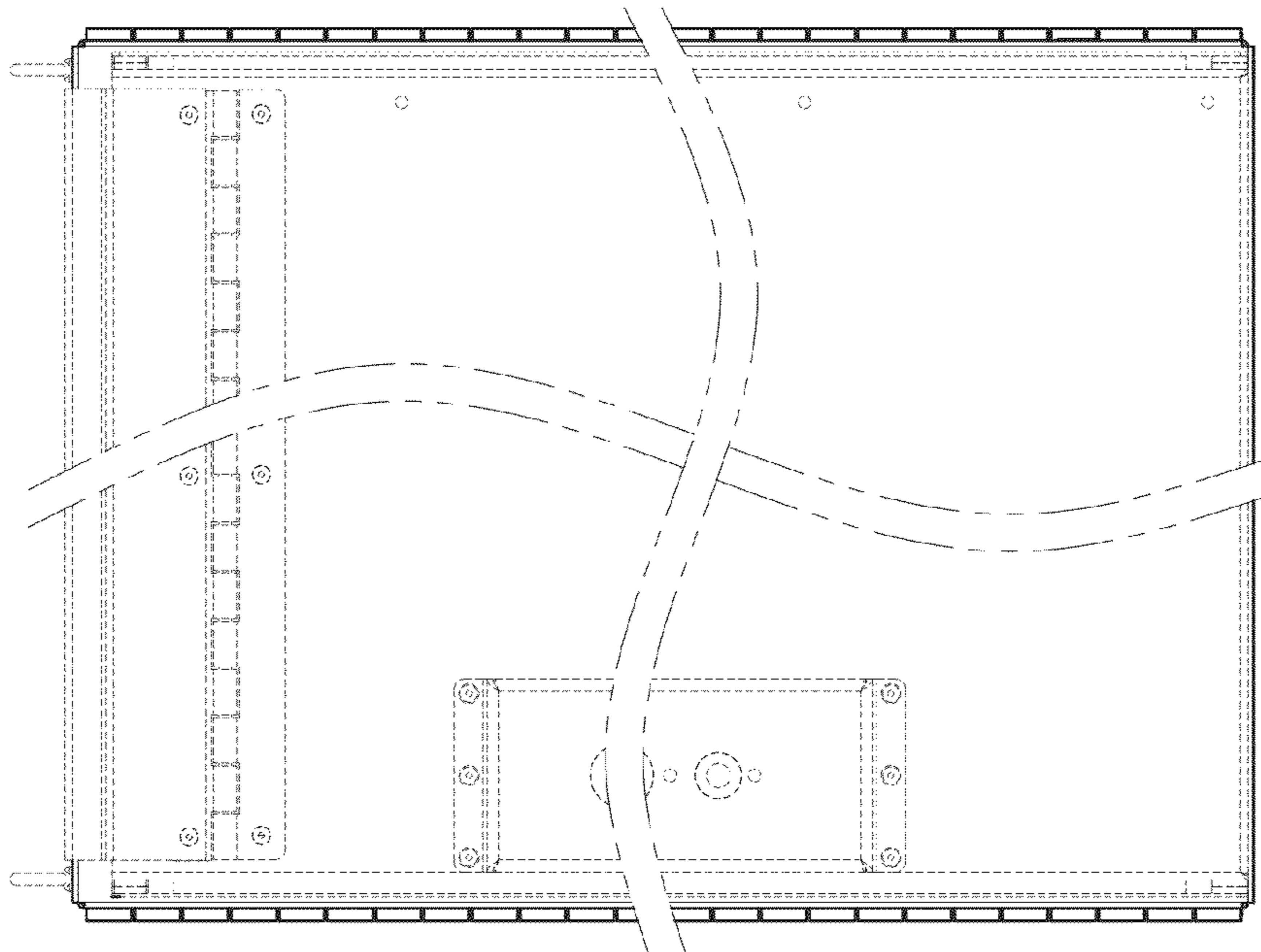

FIG. 6

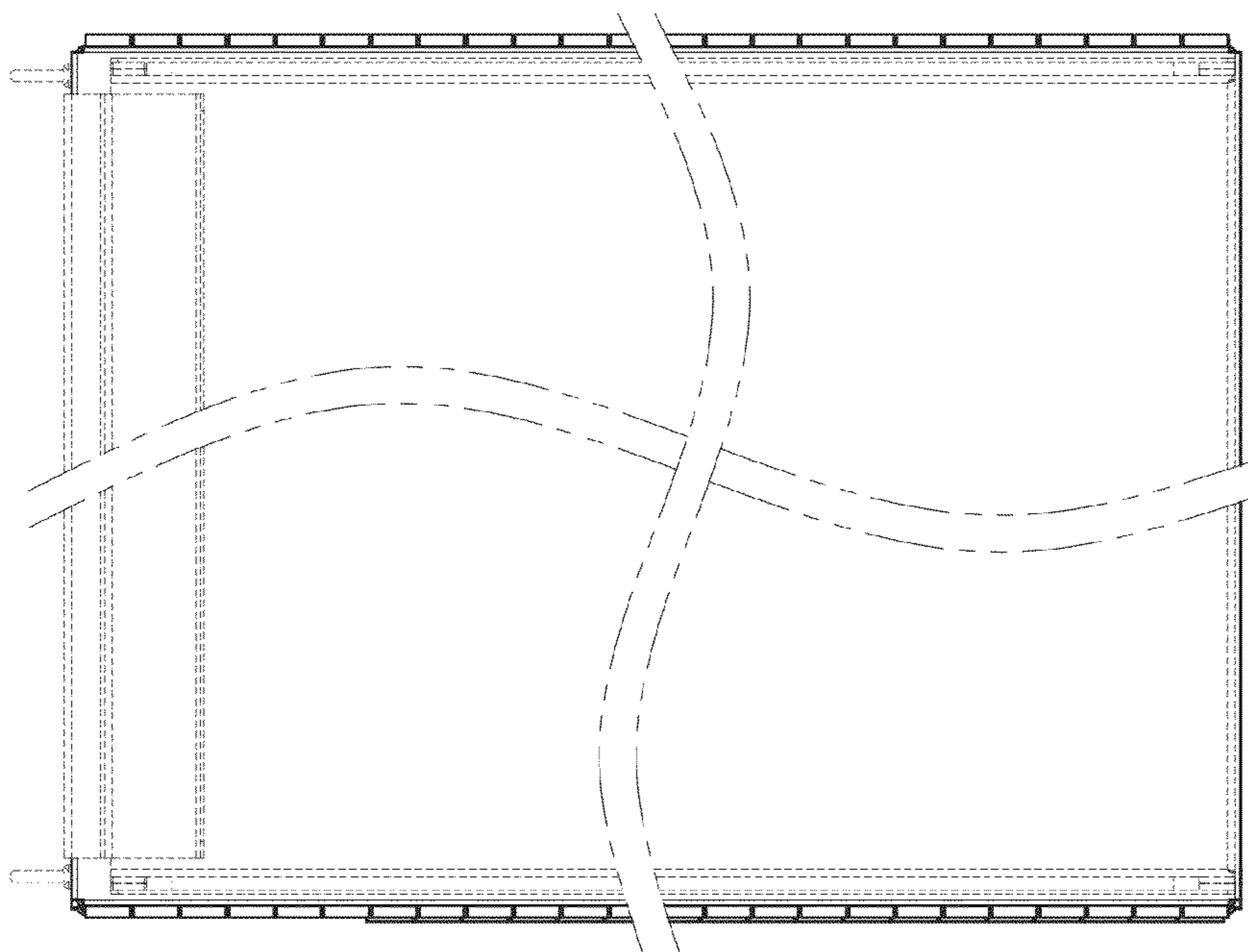

FIG. 5

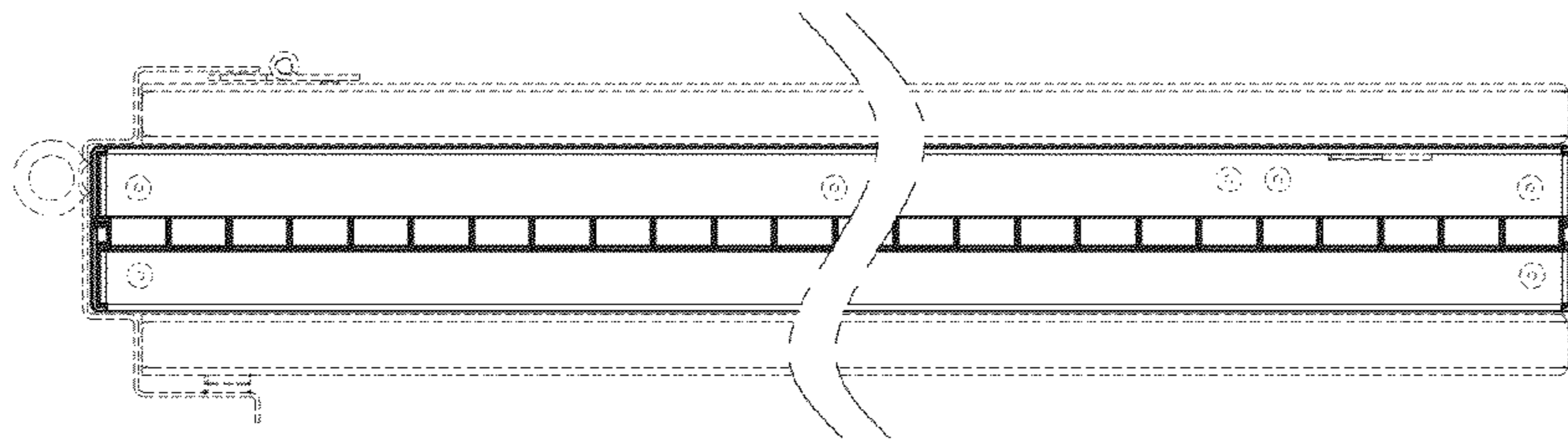

FIG. 8

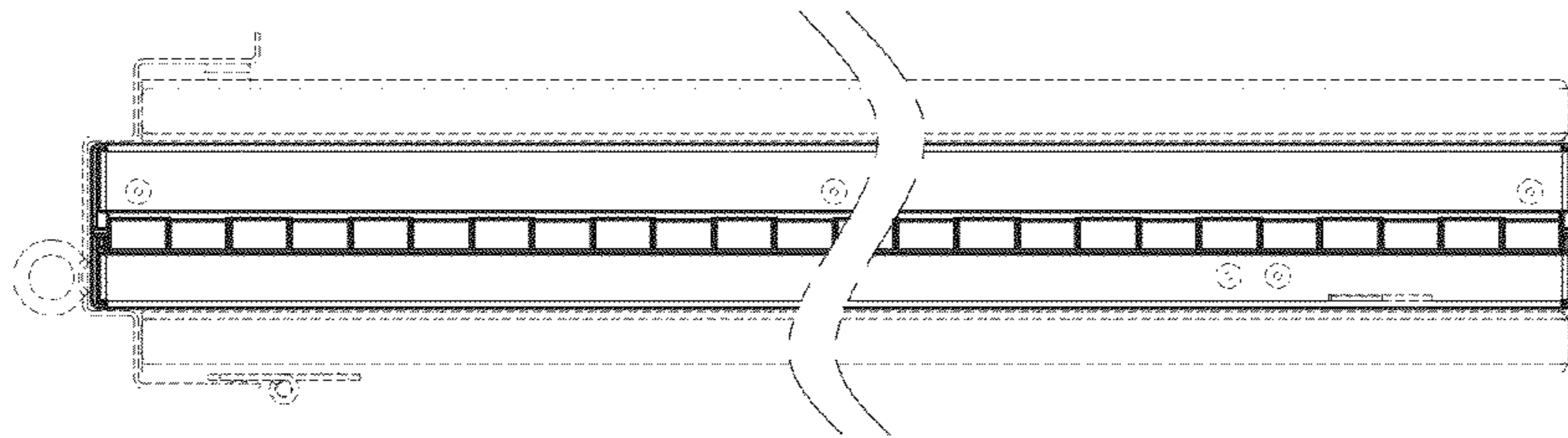

FIG. 7

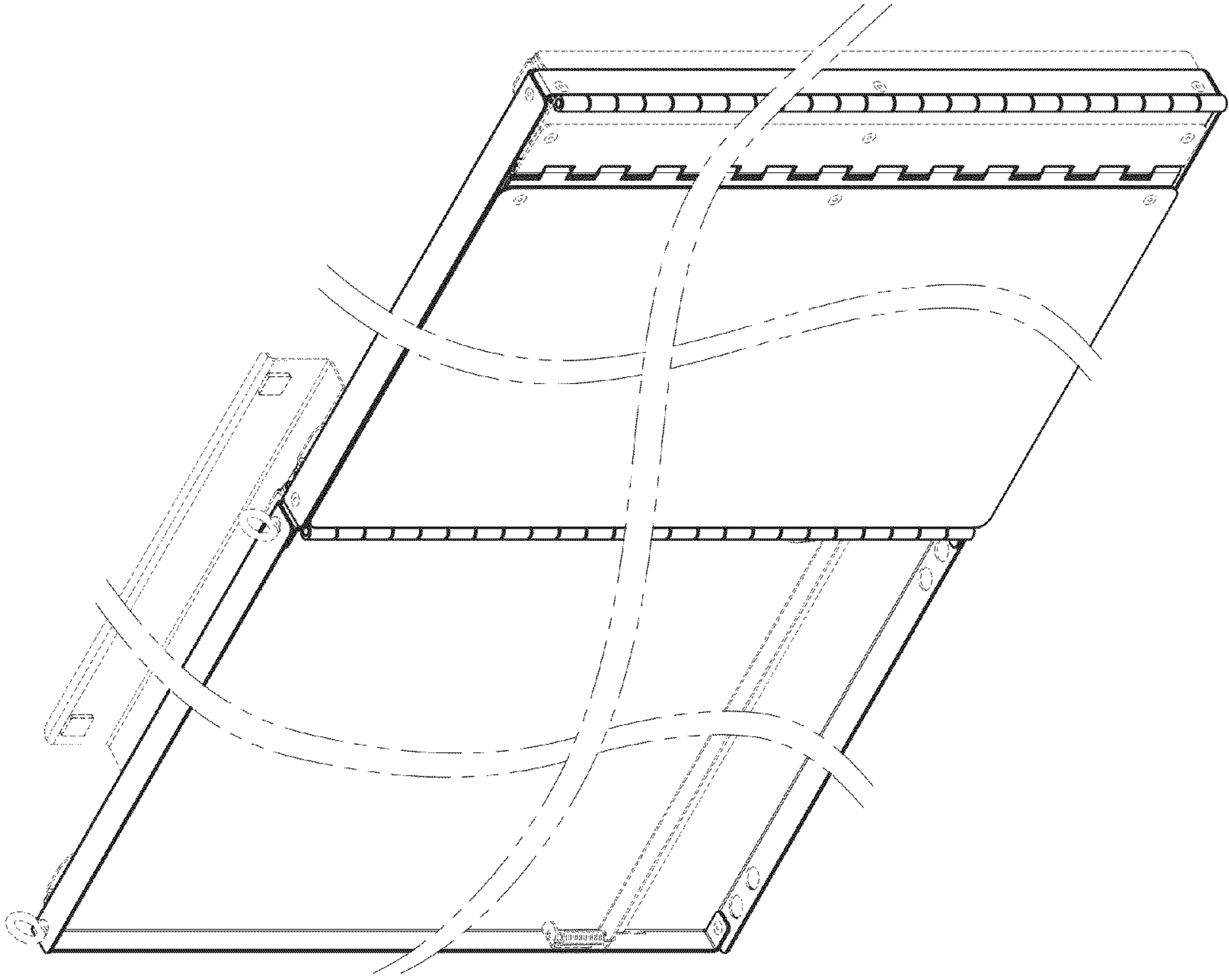

FIG. 9

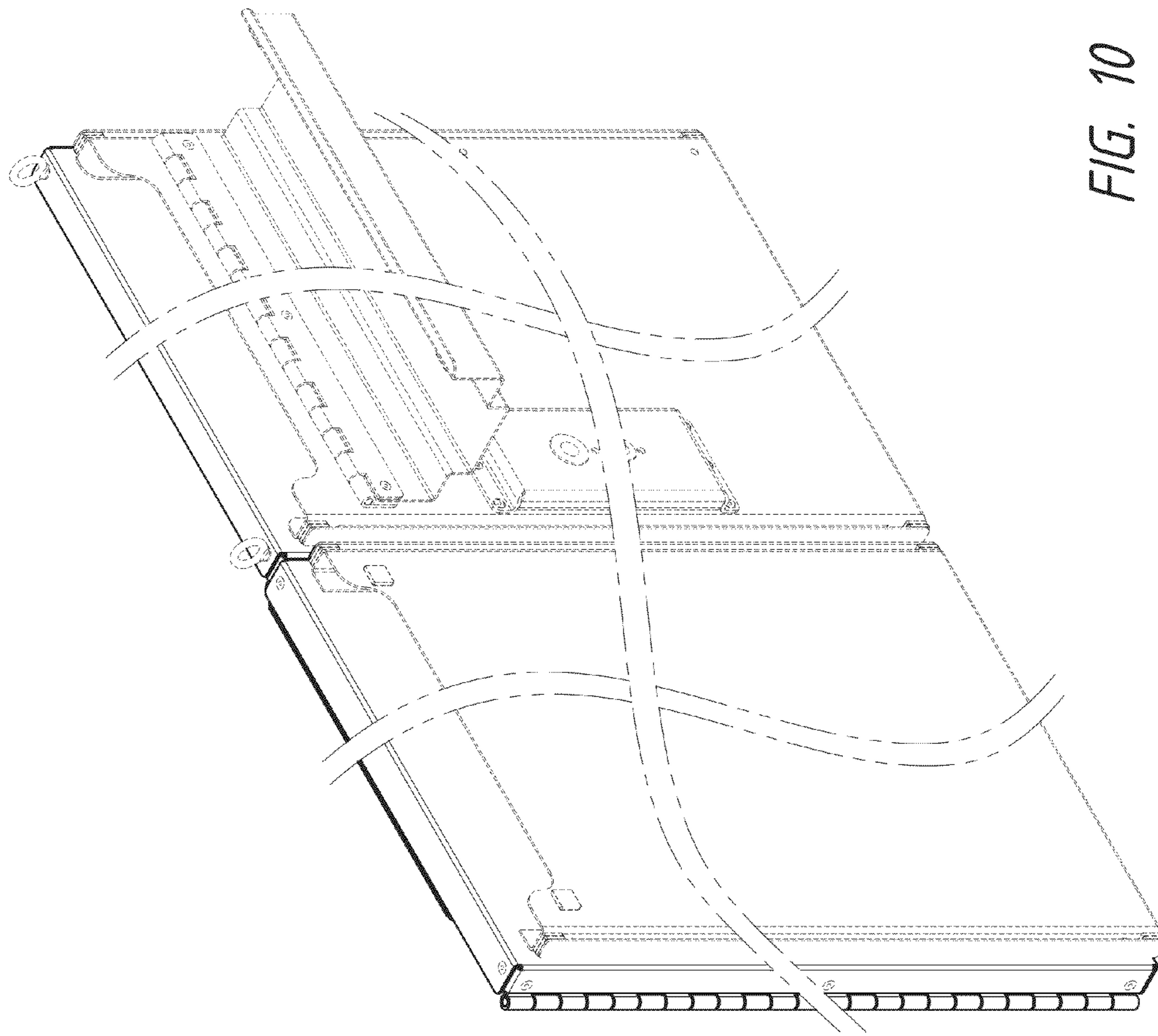

FIG. 10

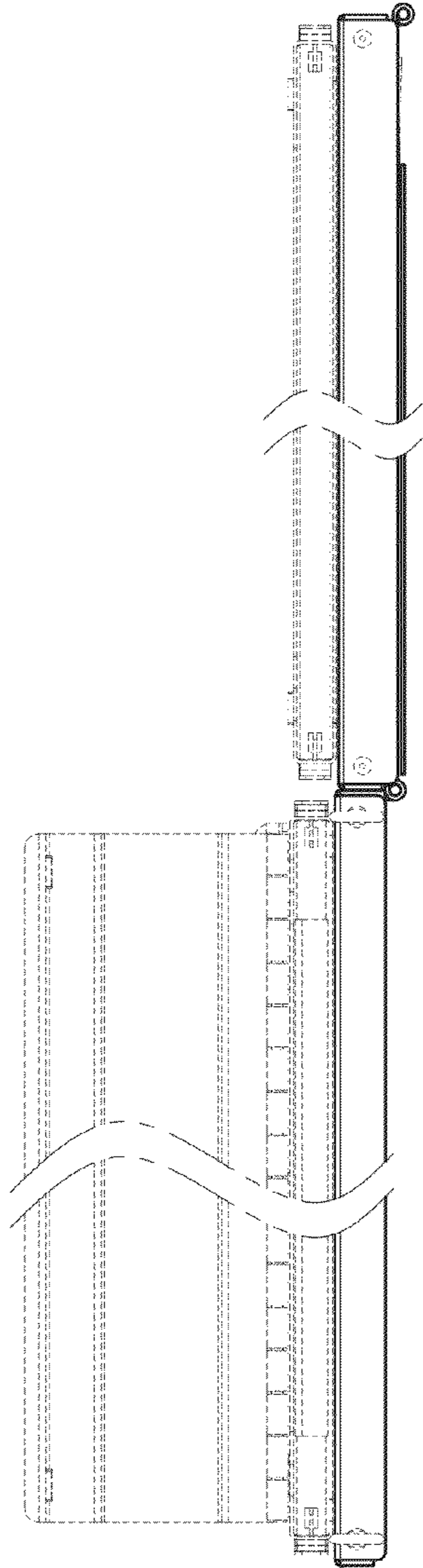

FIG. 11

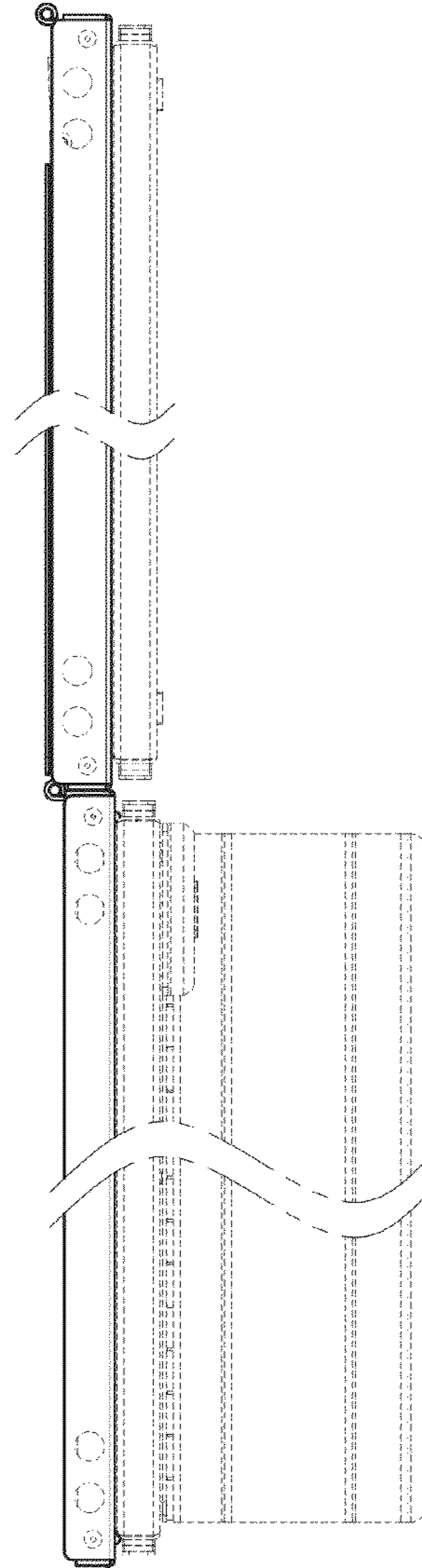

FIG. 12

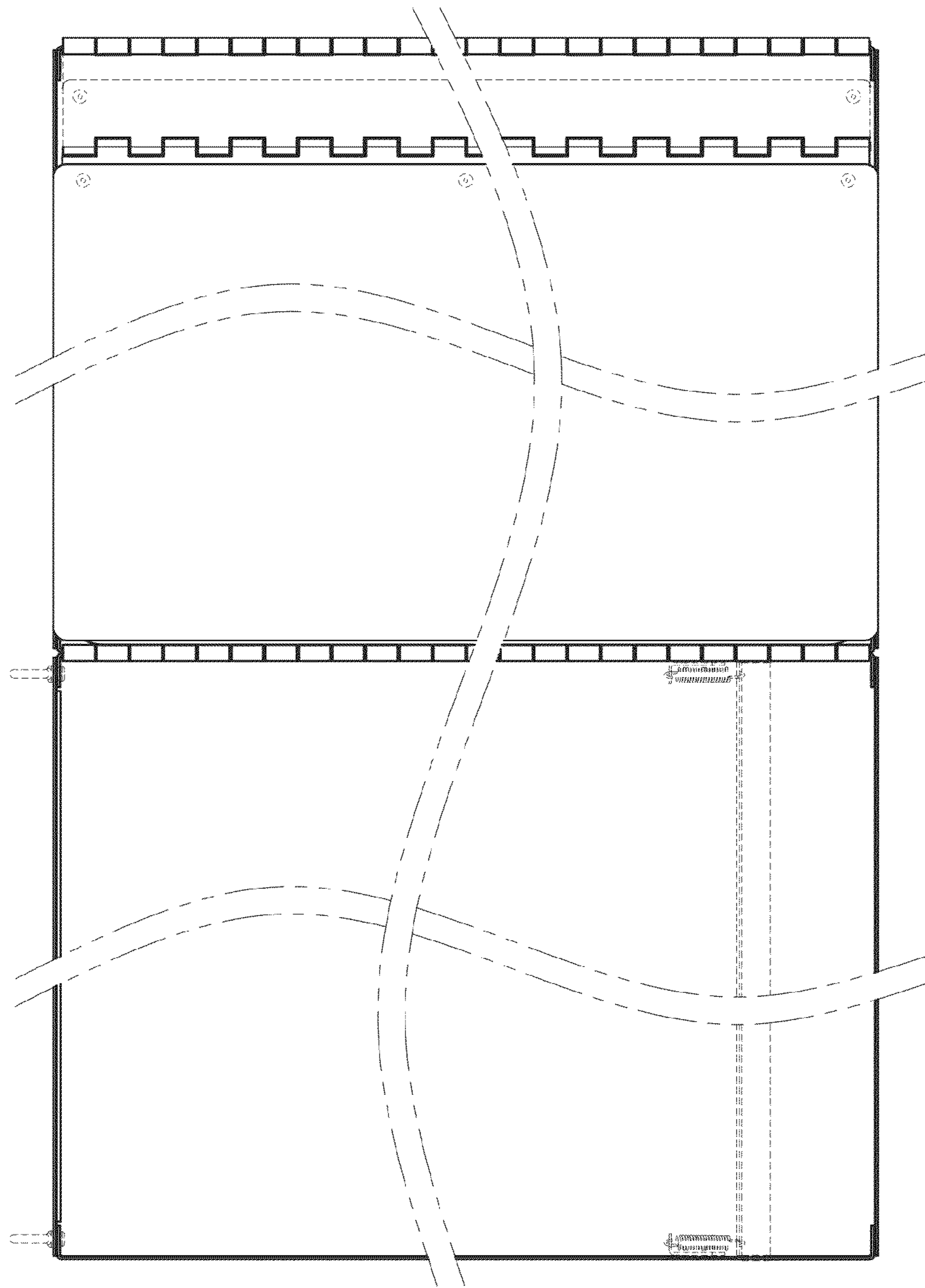

FIG. 13

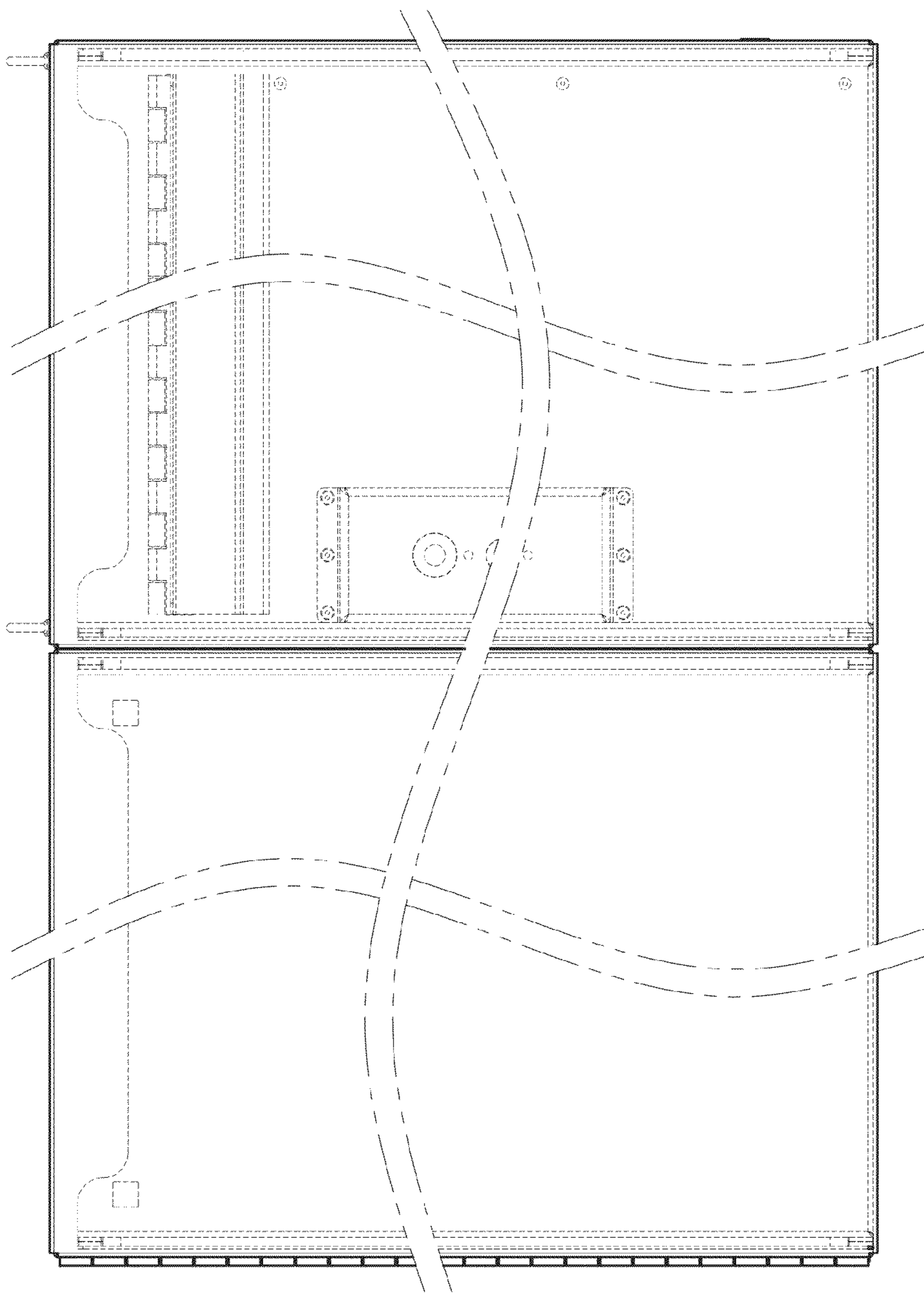

FIG. 14

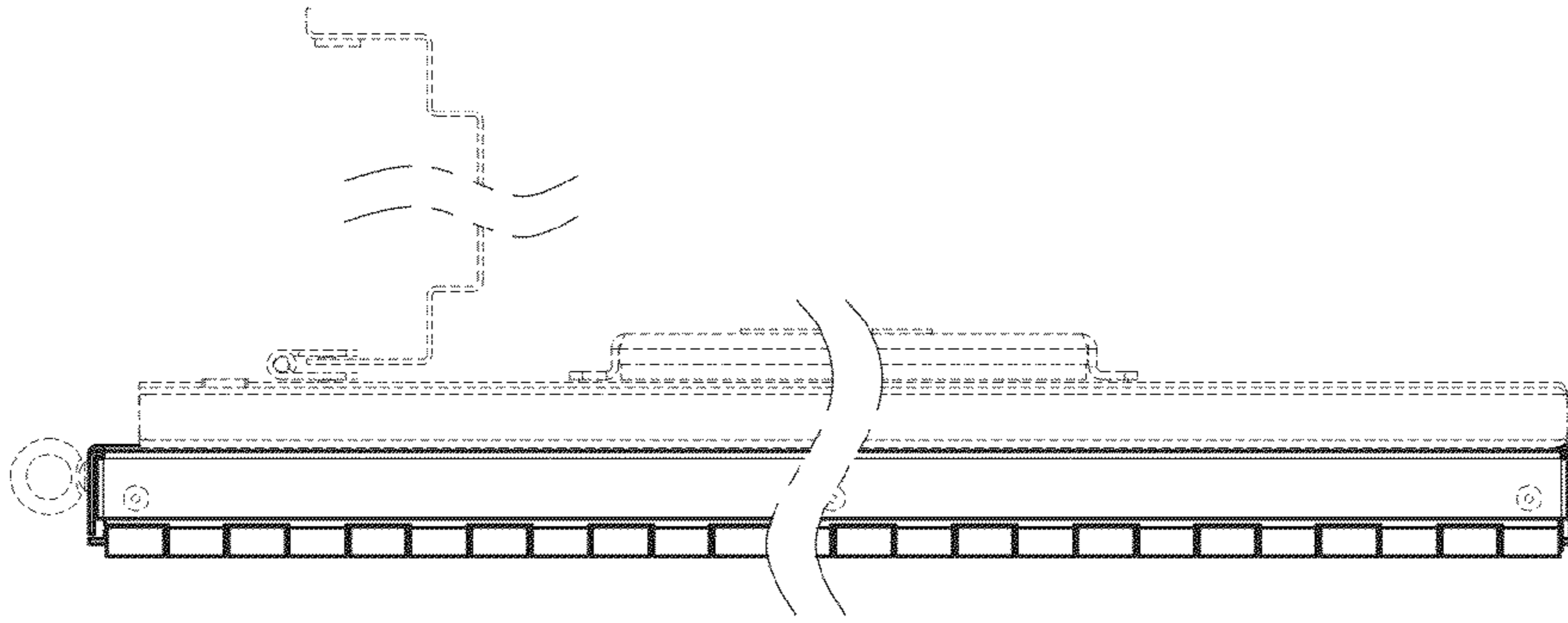

FIG. 16

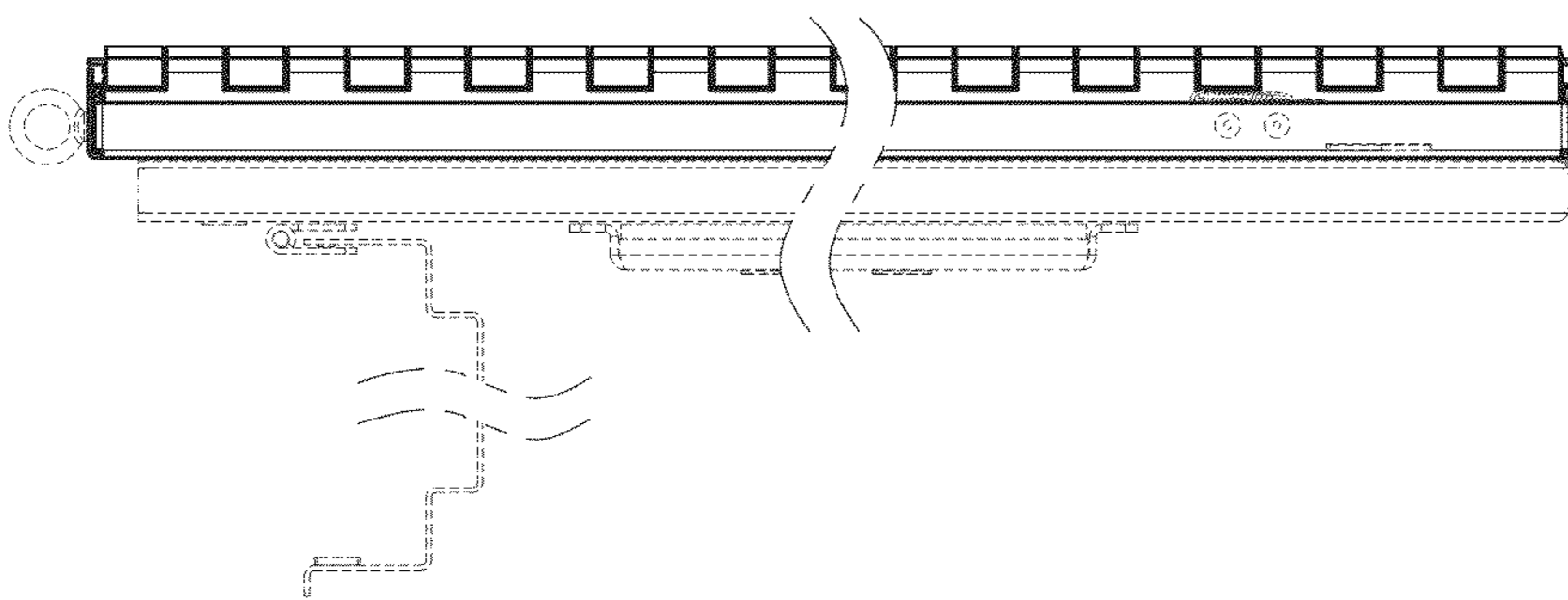

FIG. 15

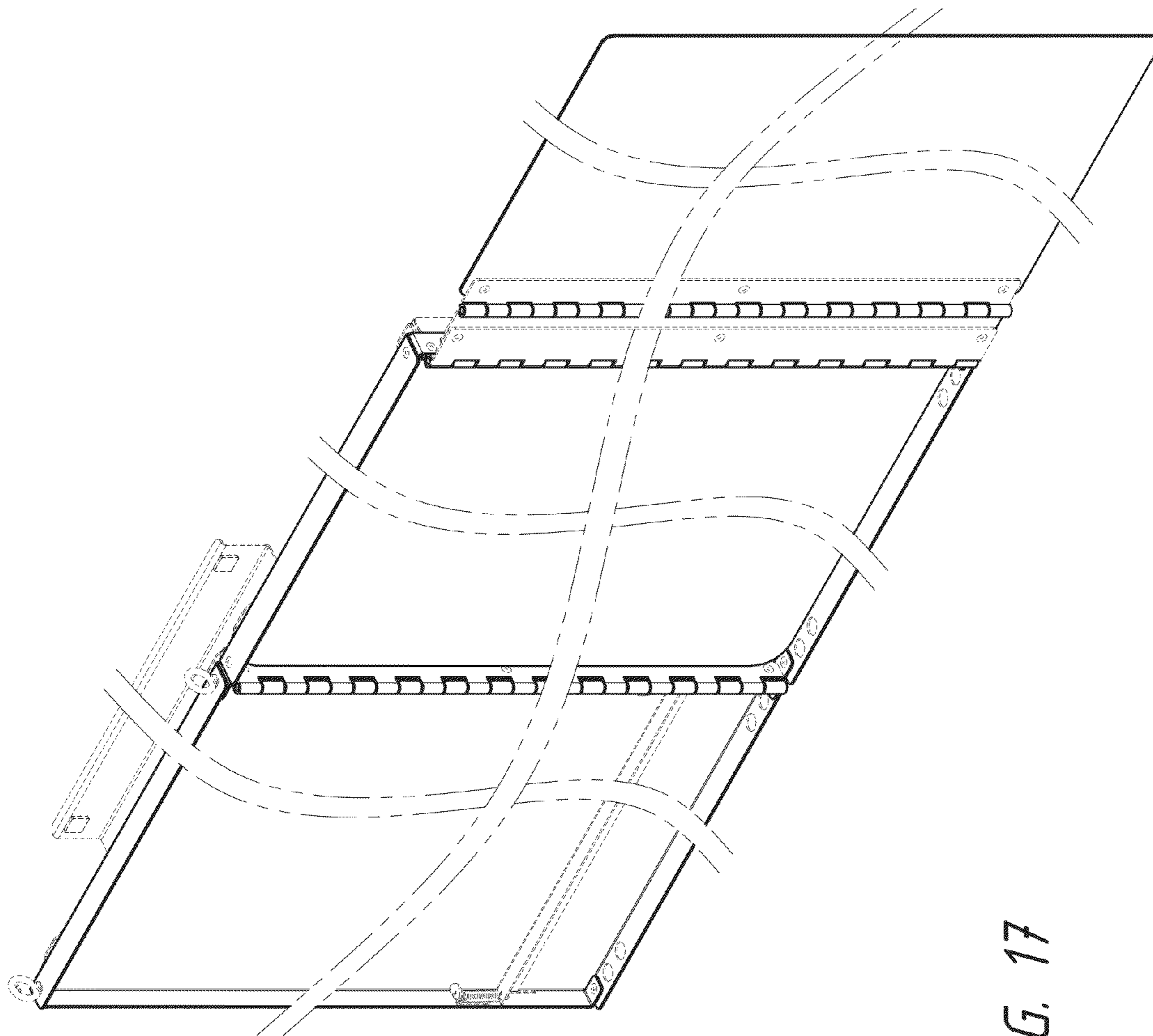

FIG. 17

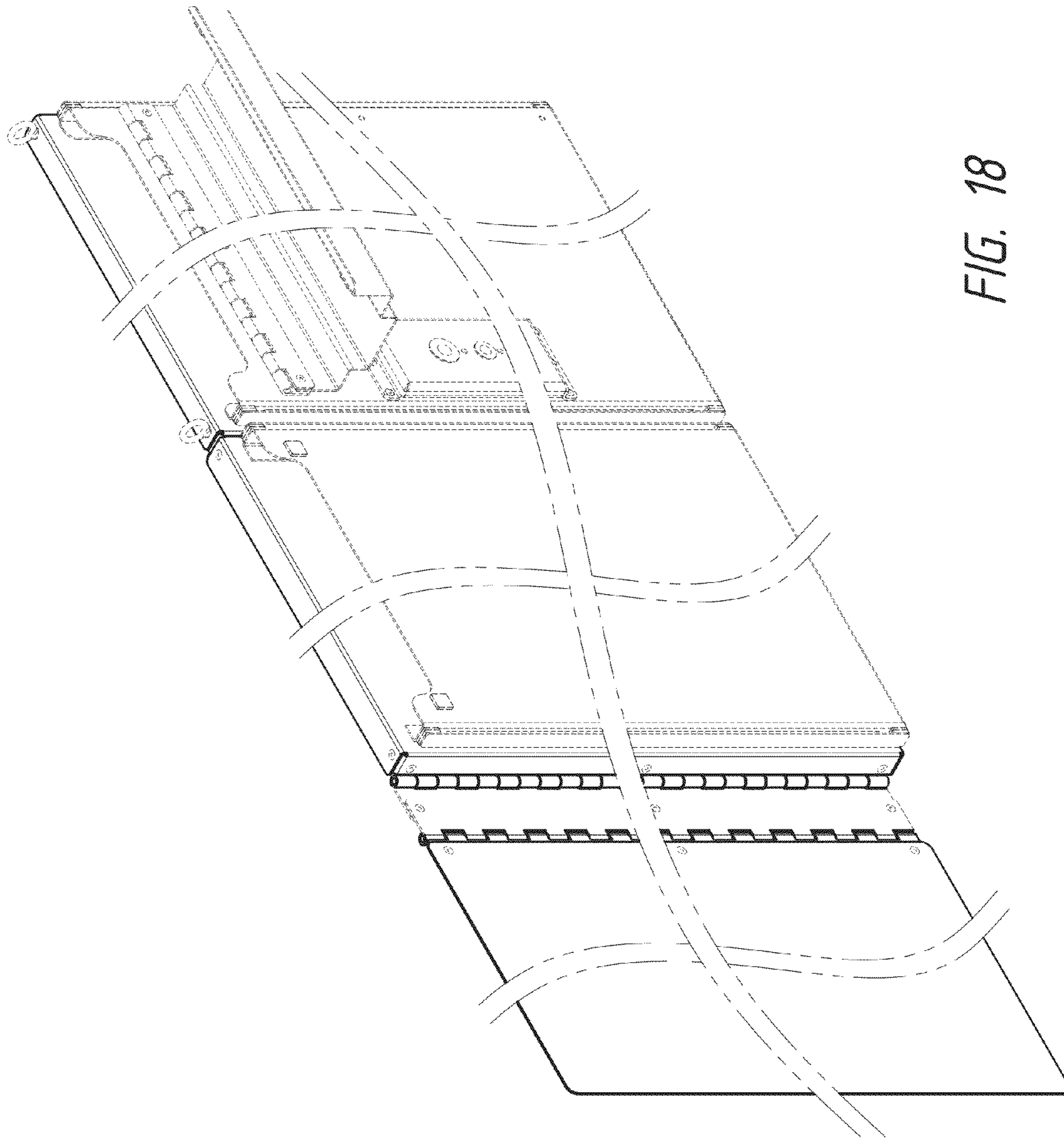

FIG. 18

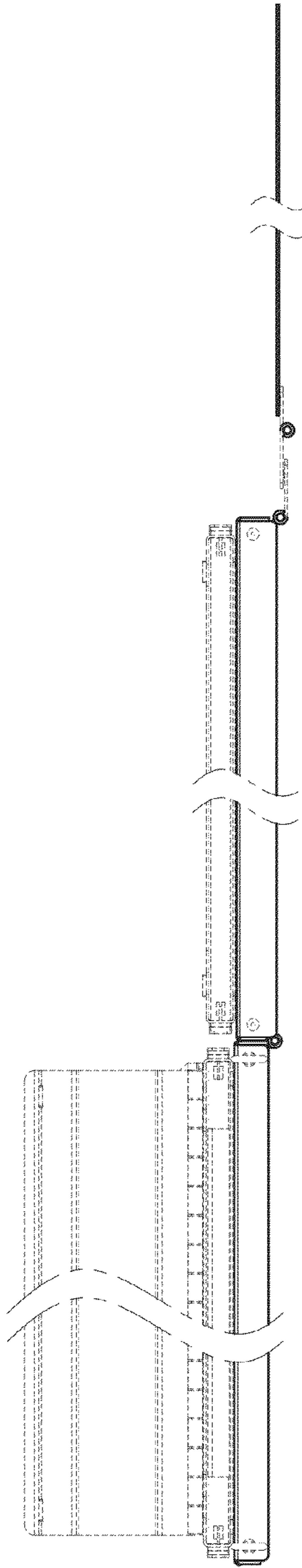

FIG. 19

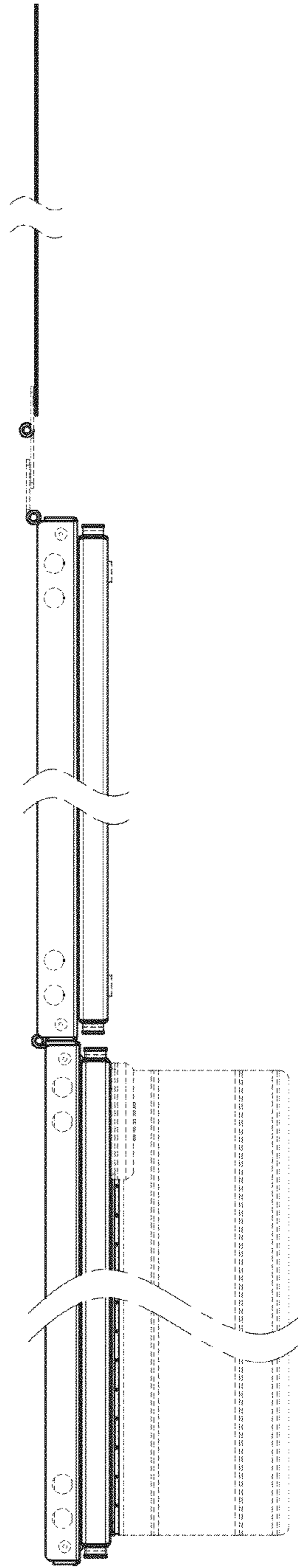

FIG. 20

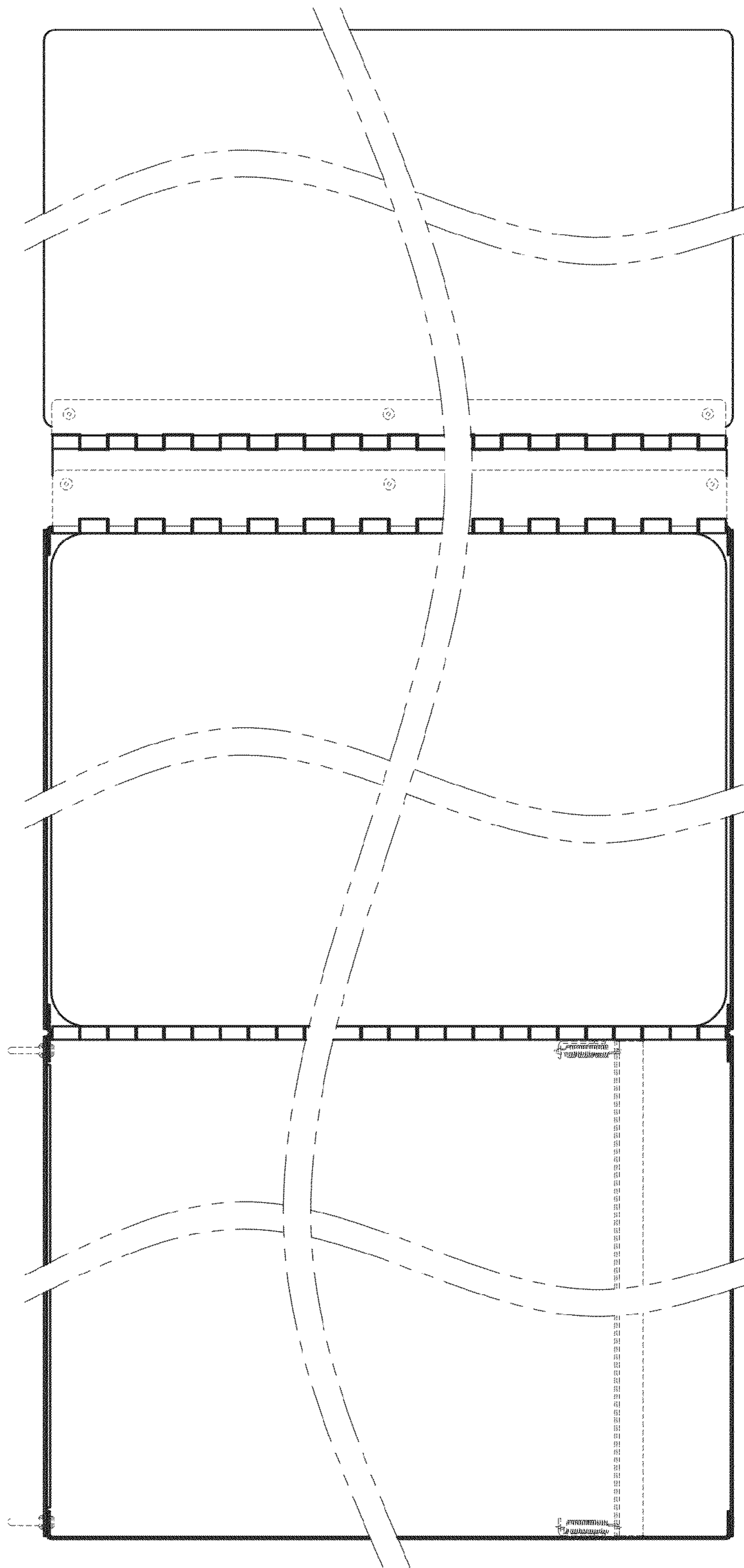

FIG. 21

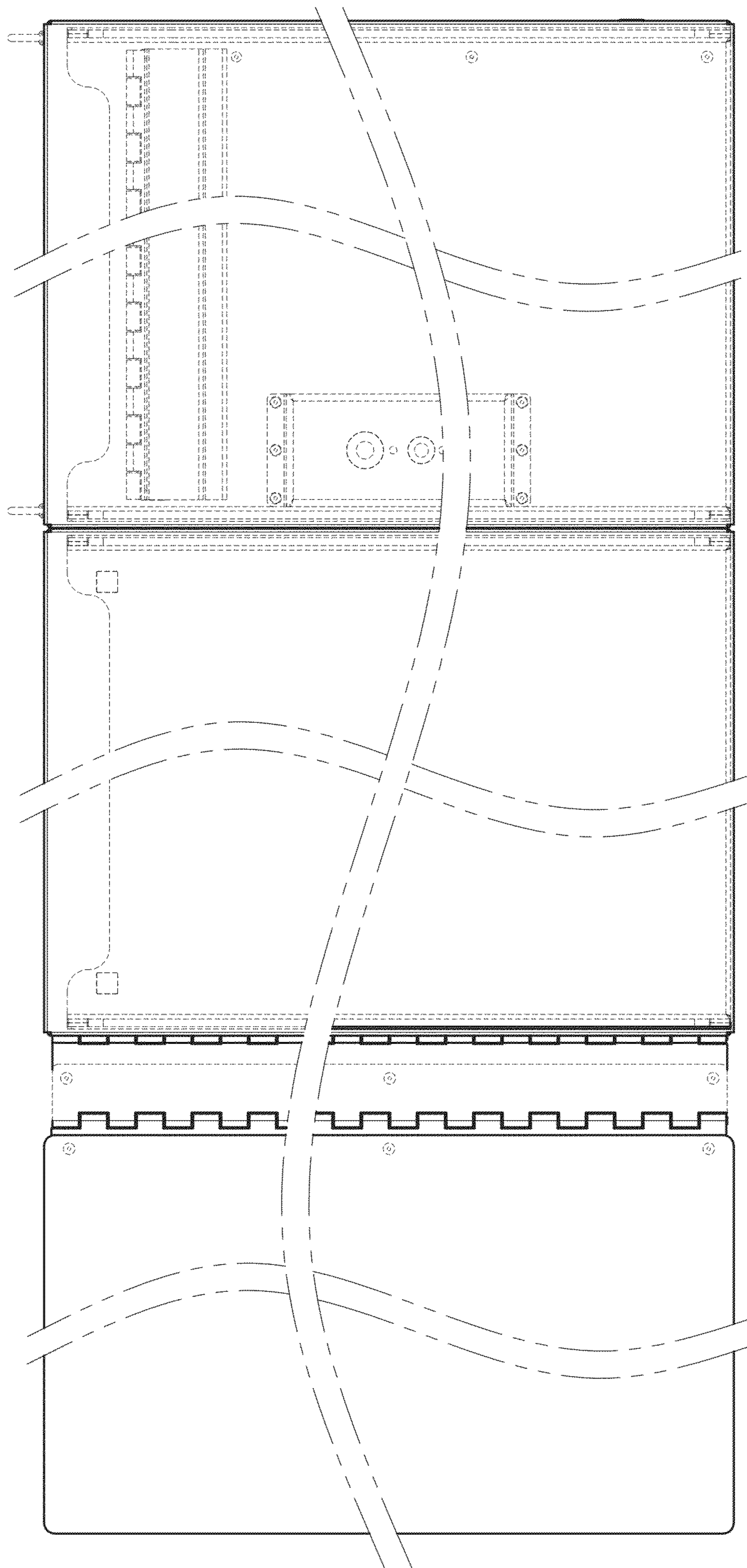

FIG. 22

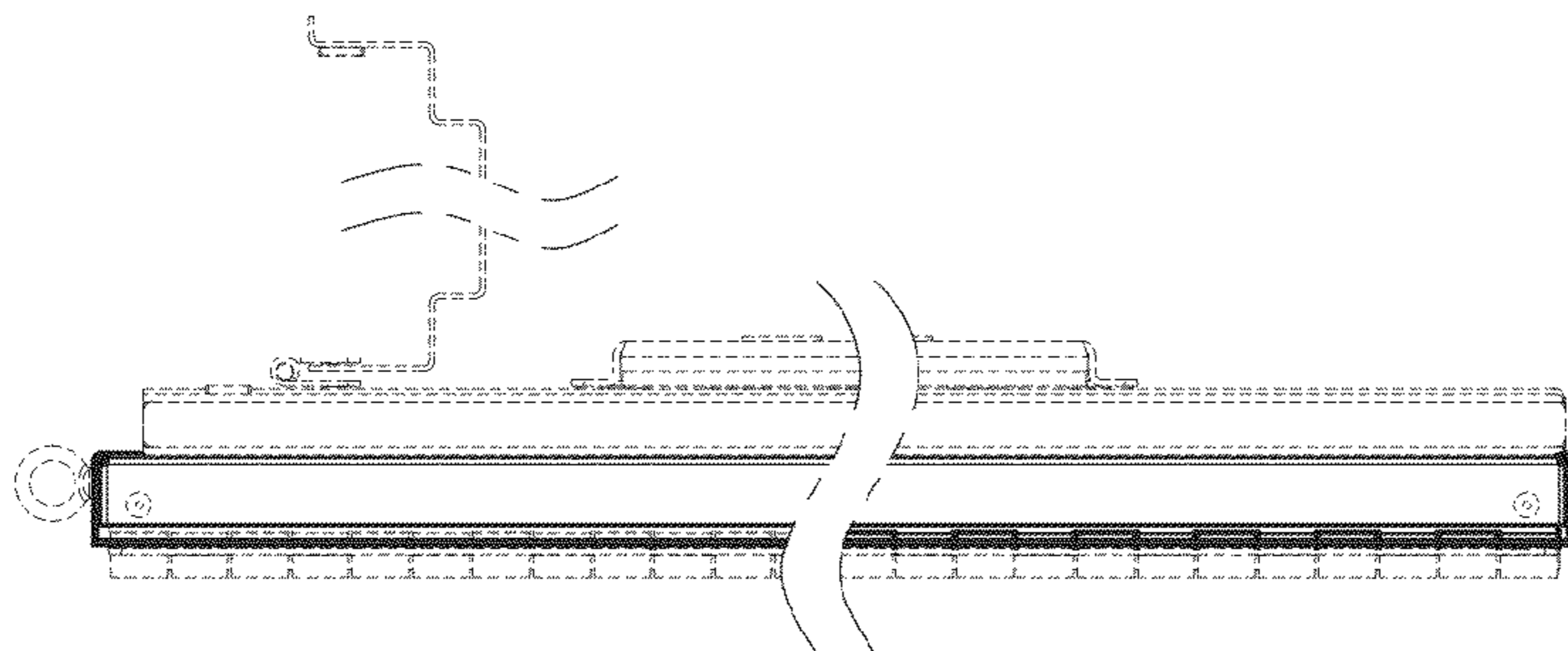

FIG. 24

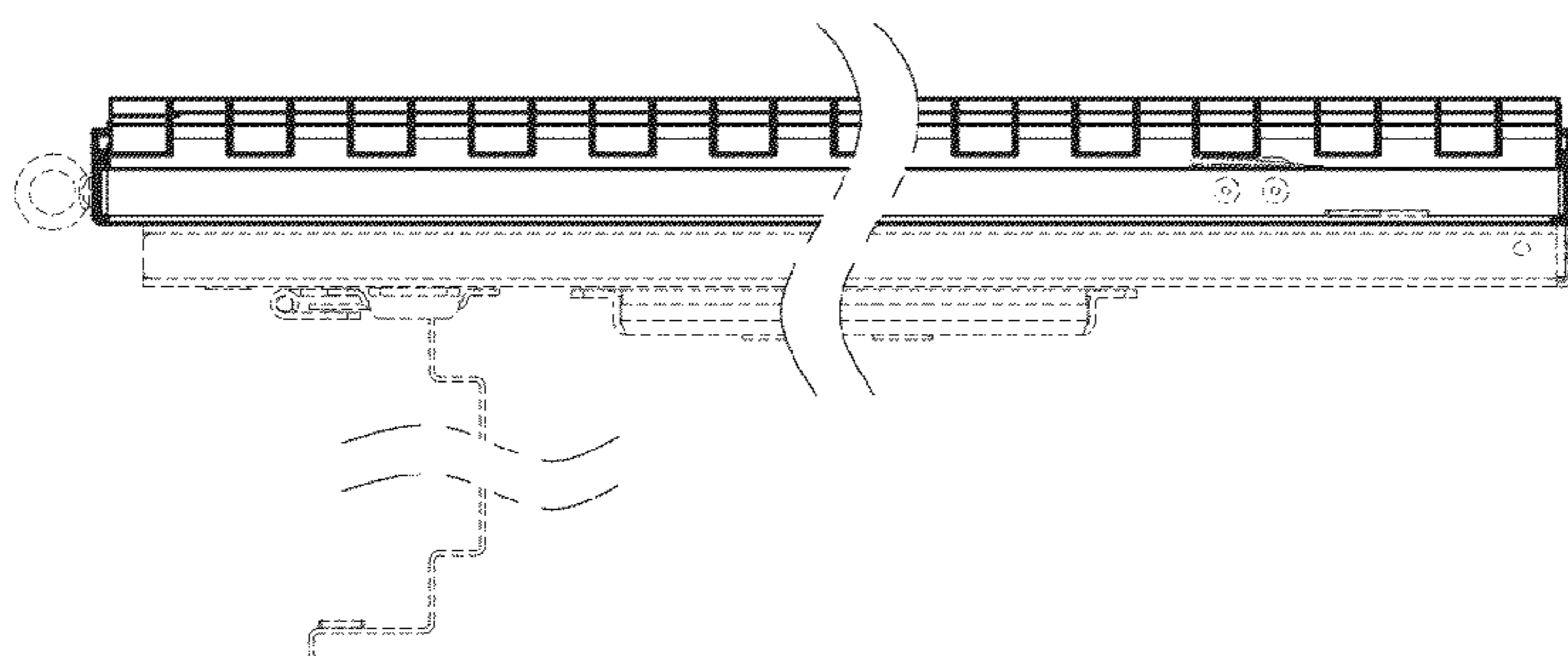

FIG. 23

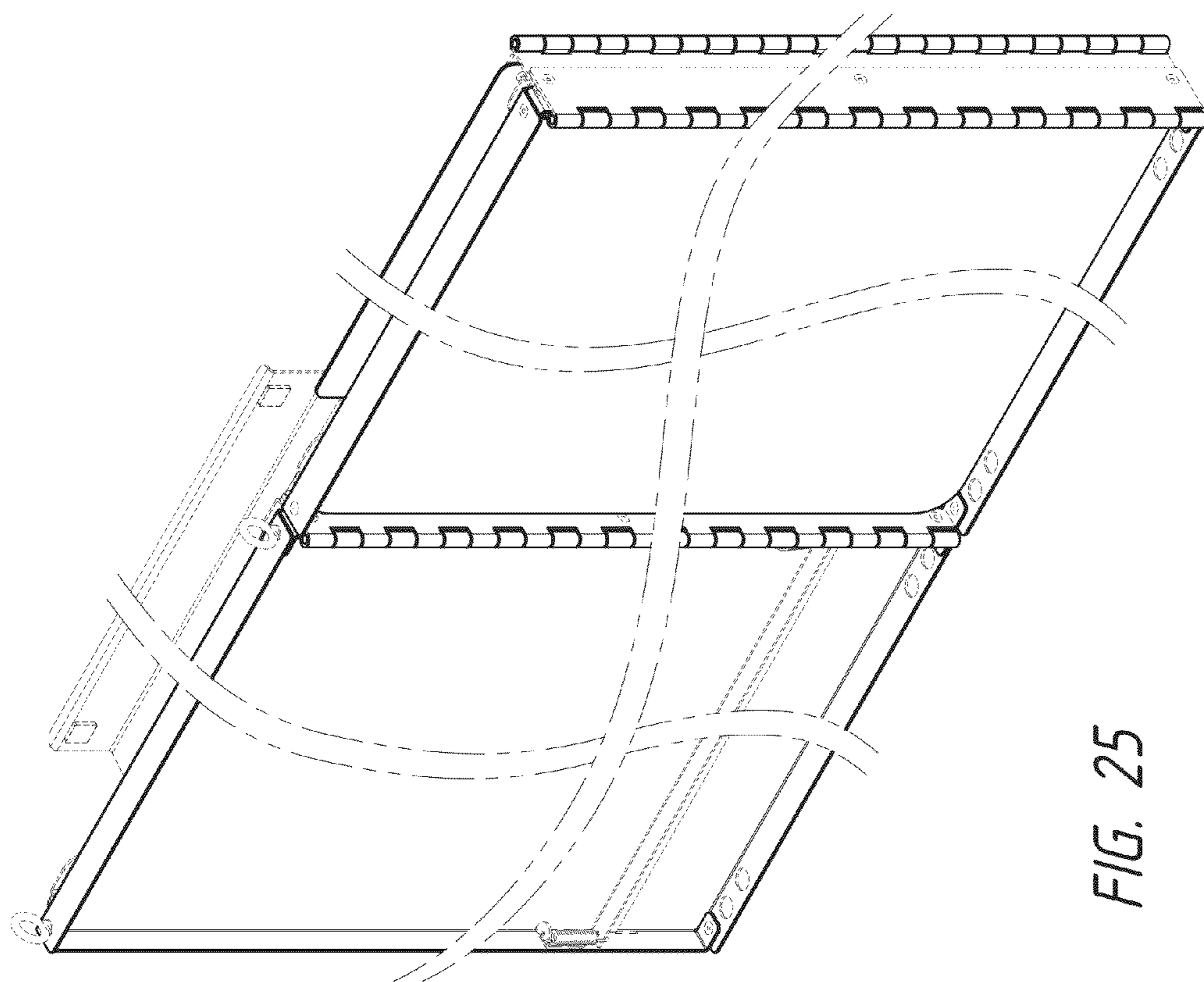

FIG. 25

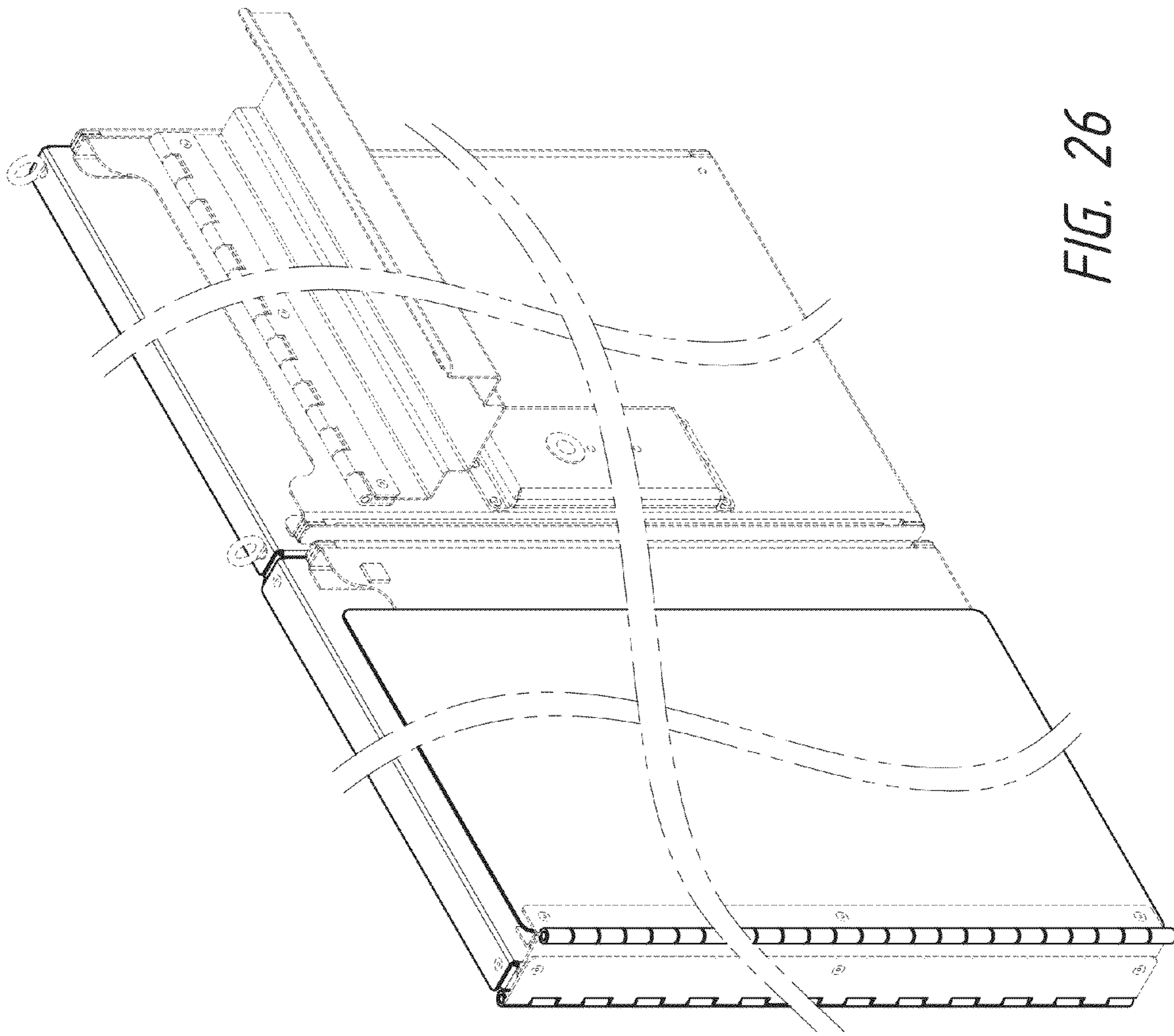

FIG. 26

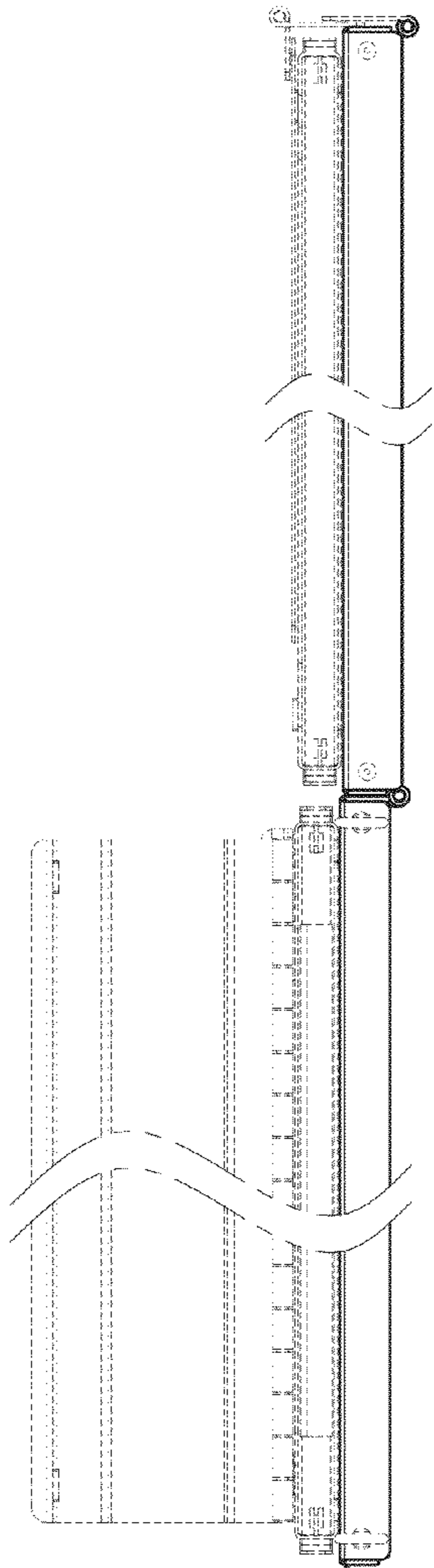

FIG. 27

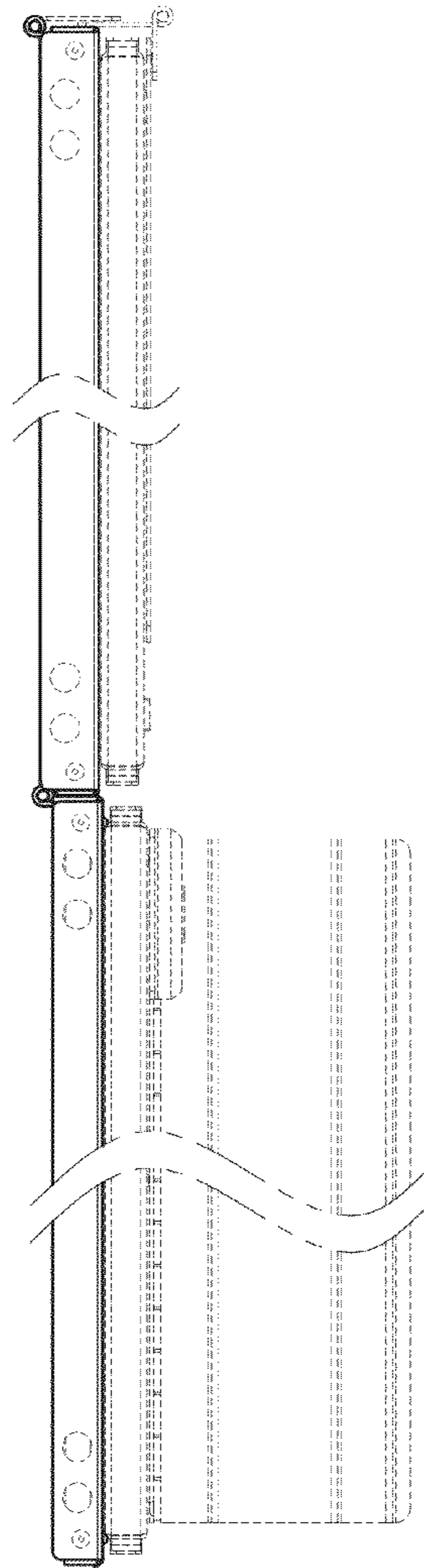

FIG. 28

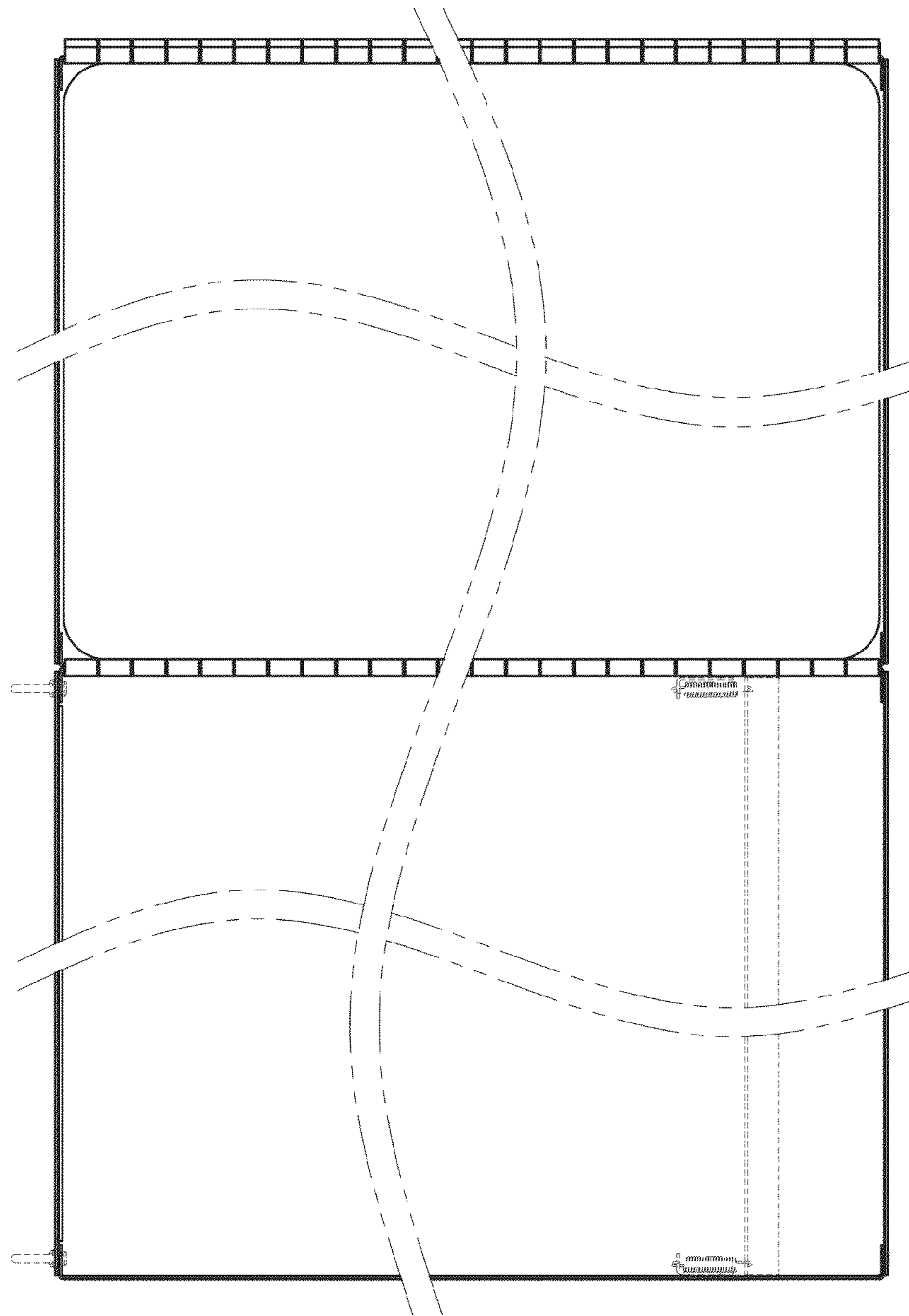

FIG. 29

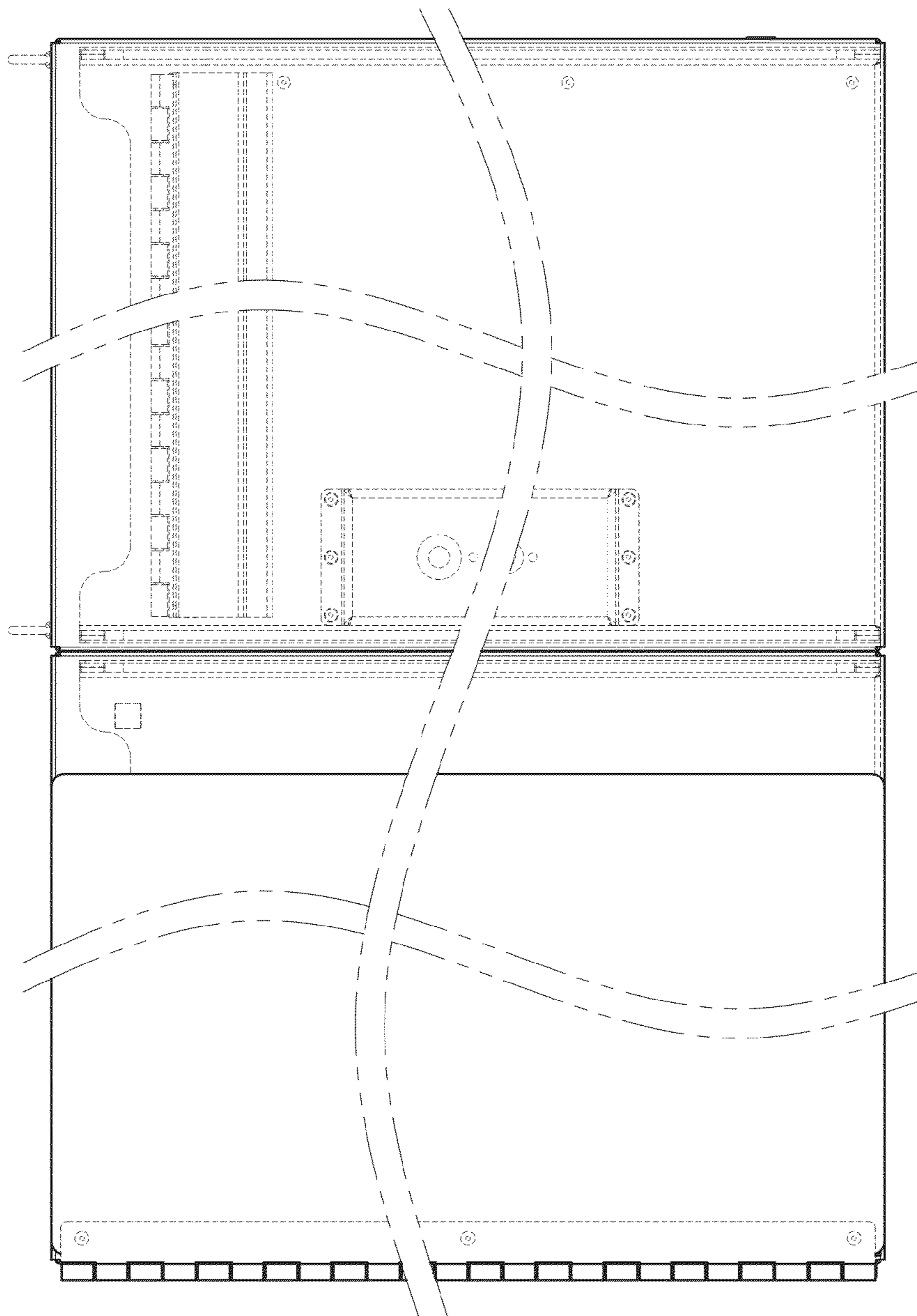

FIG. 30

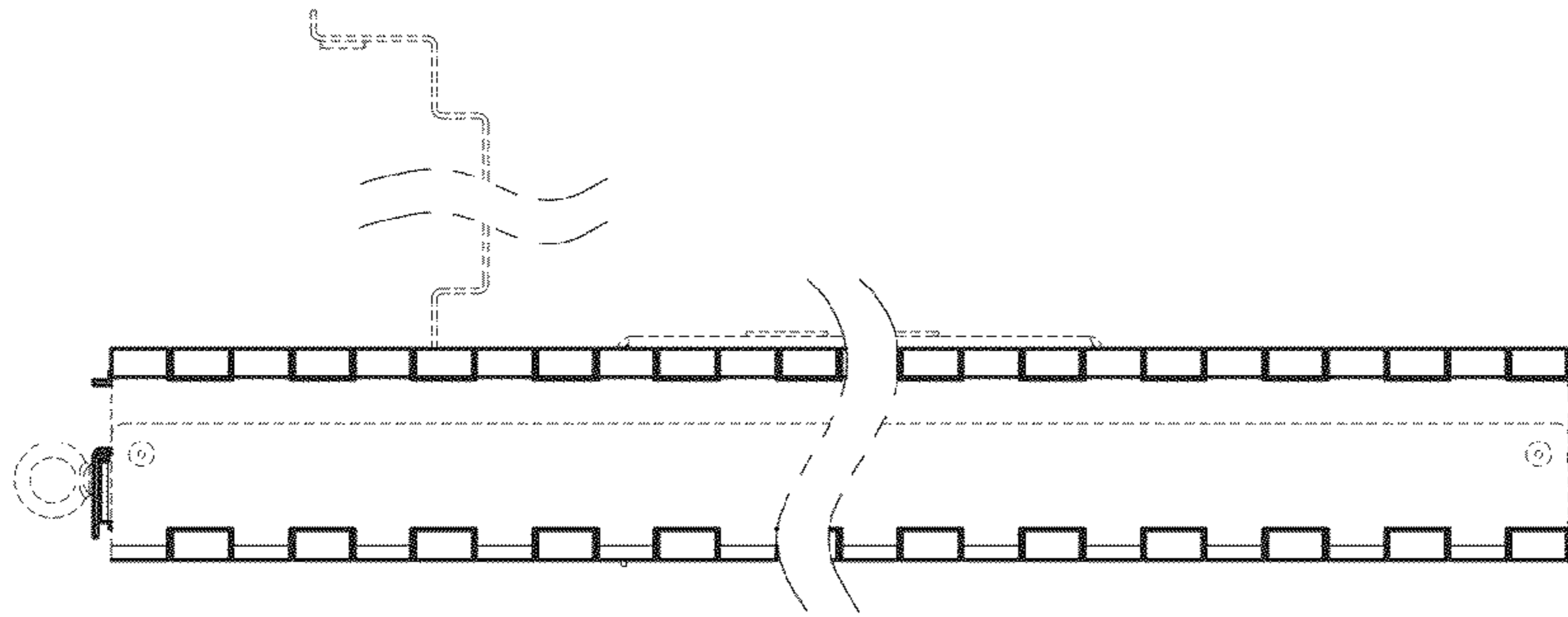

FIG. 32

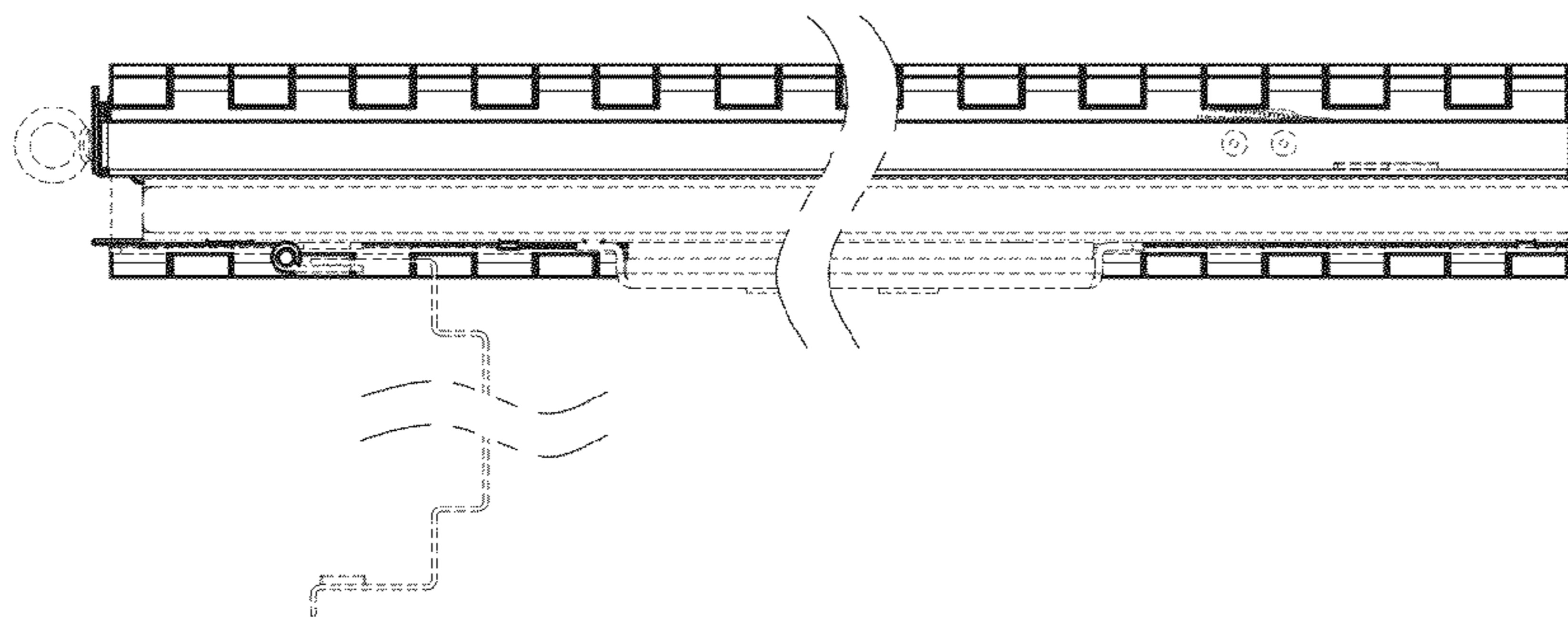

FIG. 31