

US00D756456S

(12) **United States Design Patent**
Chang

(10) **Patent No.:** **US D756,456 S**
(45) **Date of Patent:** **** May 17, 2016**

- (54) **TAPE DISPENSER**
- (71) Applicant: **CHUN NIEN PLASTIC LTD.,**
Taichung (TW)
- (72) Inventor: **Chi-Tsai Chang,** Taichung (TW)
- (73) Assignee: **CHUN NIEN PLASTIC LTD.,**
Taichung (TW)
- (**) Term: **15 Years**
- (21) Appl. No.: **29/527,414**
- (22) Filed: **May 19, 2015**
- (51) **LOC (10) Cl.** **08-02**
- (52) **U.S. Cl.**
USPC **D19/69**
- (58) **Field of Classification Search**
USPC D19/36, 70, 69, 68; D13/133, 146;
242/588.6, 588.3, 588.2; 225/77, 6, 56,
225/69, 26, 25, 19, 11; 206/411; 156/577,
156/527, 523
CPC .. B65H 37/005; B65H 270/37; B65H 35/006;
B65H 35/0026; B65H 35/0073; B65H 35/0033
See application file for complete search history.

- D700,241 S * 2/2014 Turner D19/69
- 8,720,763 B2 * 5/2014 Kuehn B26F 3/02
225/39
- D713,875 S * 9/2014 Packard D19/69
- D720,807 S * 1/2015 Jianvarakul D19/69
- 8,978,594 B2 * 3/2015 Daniels A01K 27/004
119/795

* cited by examiner

Primary Examiner — Austin Murphy

(74) *Attorney, Agent, or Firm* — Muncy, Geissler, Olds & Lowe, P.C.

(57) **CLAIM**

I claim the ornamental design for a tape dispenser, as shown and described.

DESCRIPTION

FIG. 1 is a perspective view of a tape dispenser showing my new design;
 FIG. 2 is a front elevational view thereof;
 FIG. 3 is a rear elevational view thereof;
 FIG. 4 is a left side view thereof;
 FIG. 5 is a right side view thereof;
 FIG. 6 is a top plan view thereof; and,
 FIG. 7 is a bottom plan view of the tape dispenser.
 The broken lines in the drawings illustrate portions of the tape dispenser which form no part of the claimed design.
 The dot-dashed lines in FIGS. 1, 2, 3, 4, 5 and 7 define the boundary of claimed and unclaimed objects, and the dot-dashed line forms no part of the claimed design.

1 Claim, 5 Drawing Sheets

(56) **References Cited**

U.S. PATENT DOCUMENTS

- D541,348 S * 4/2007 Mandel D19/69
- D543,244 S * 5/2007 Tsuruha D19/73
- D571,405 S * 6/2008 Boulais D19/69
- D607,458 S * 1/2010 Hui D14/300
- D694,963 S * 12/2013 Daniels D30/153

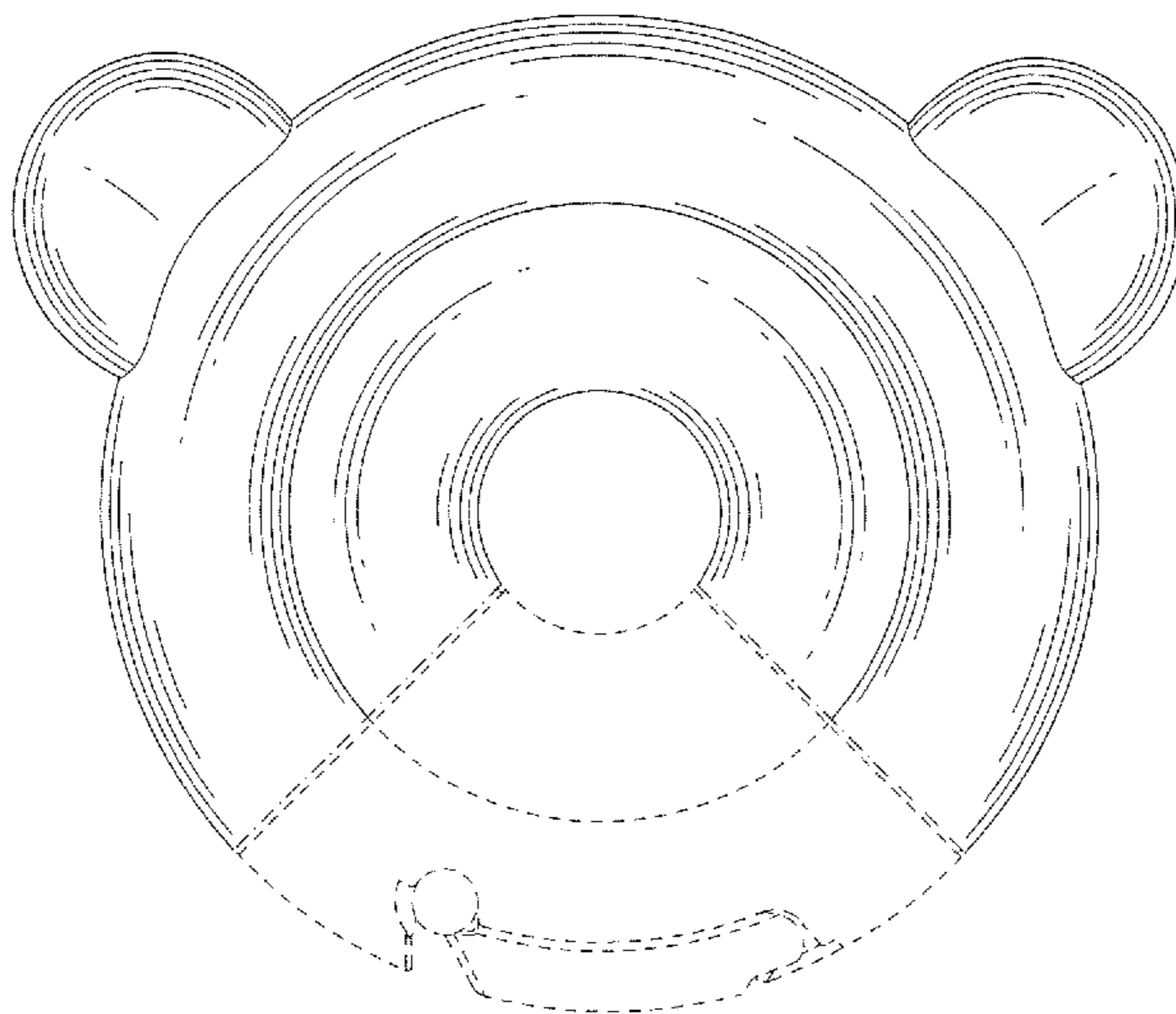

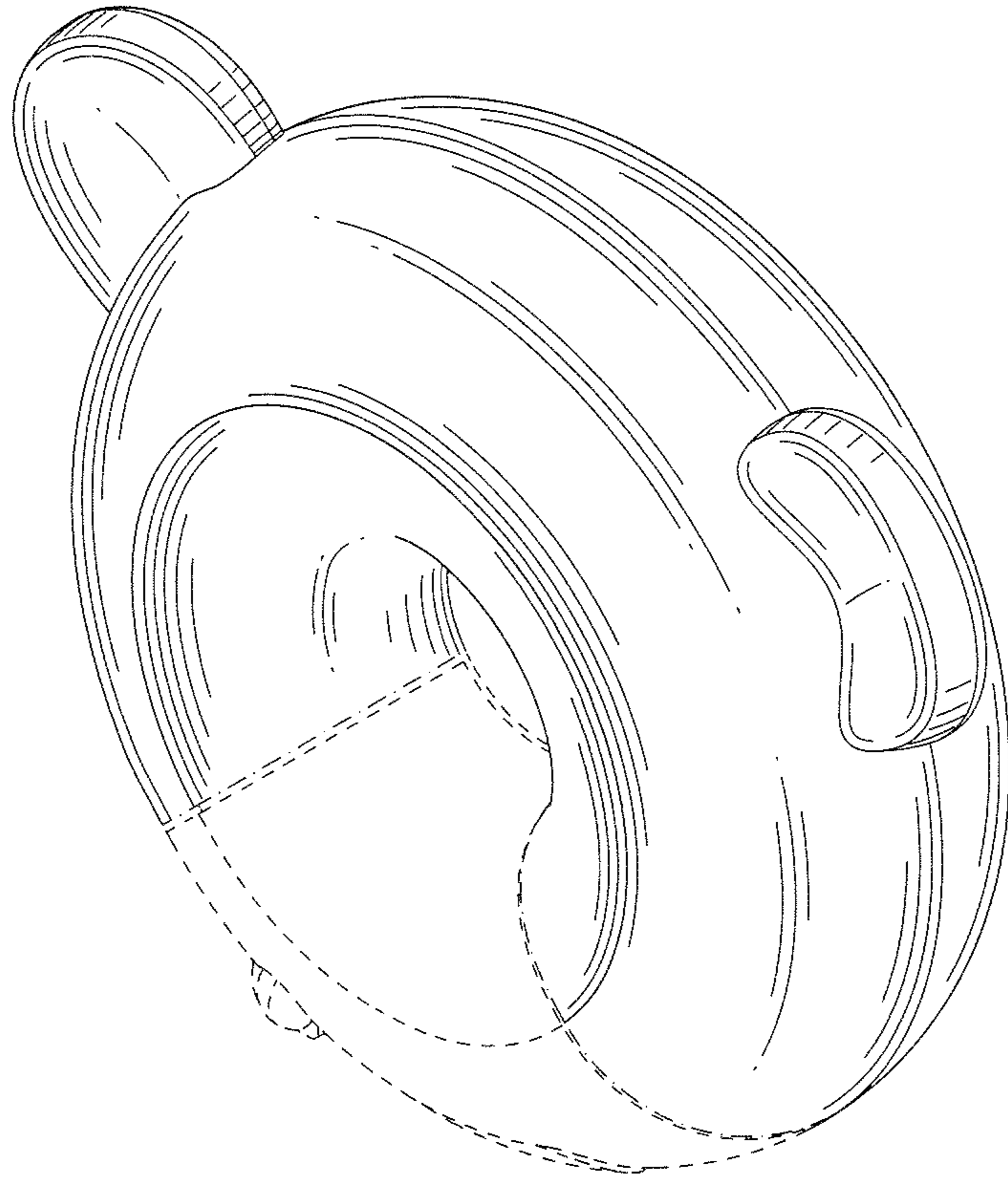

FIG. 1

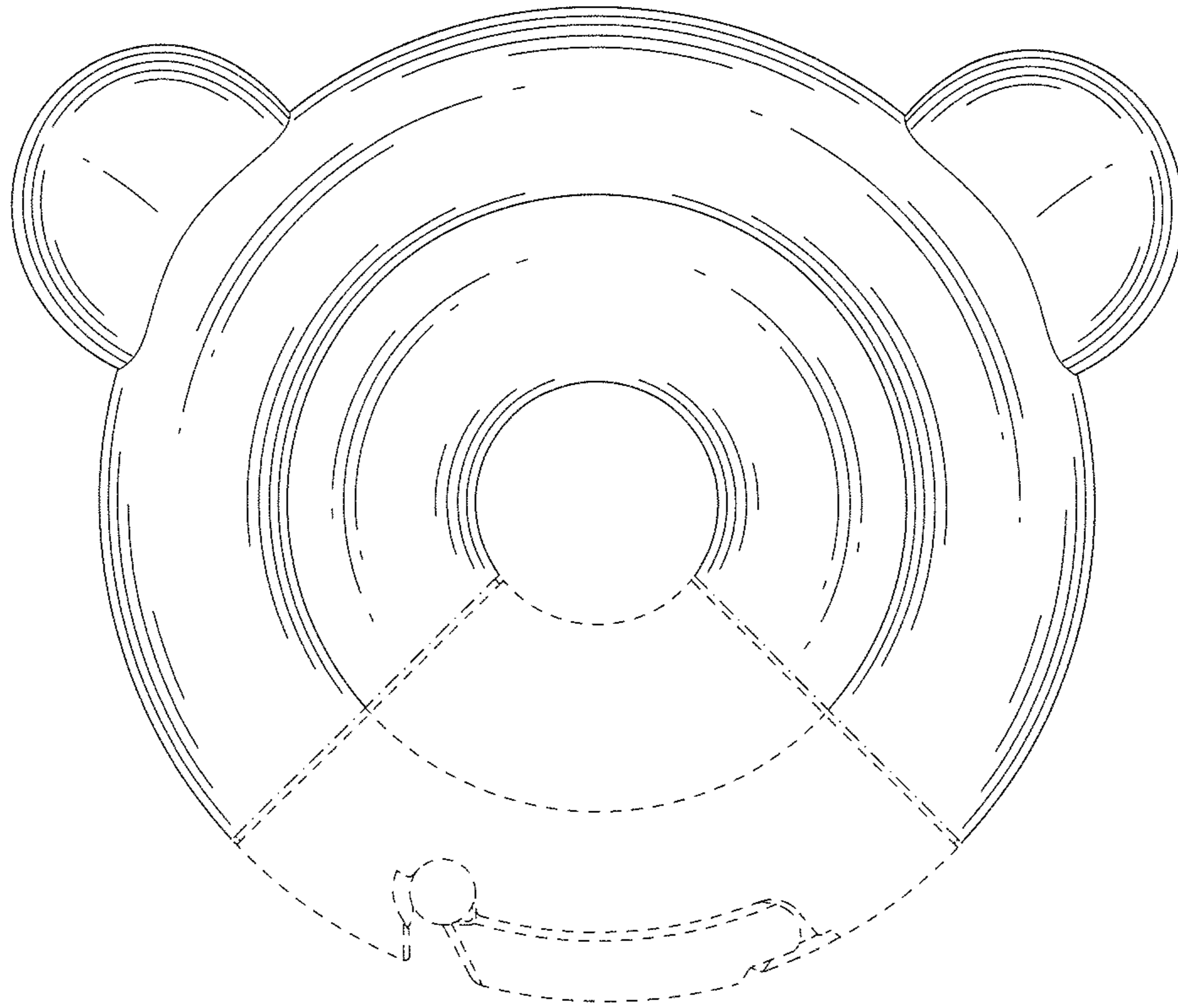

FIG. 2

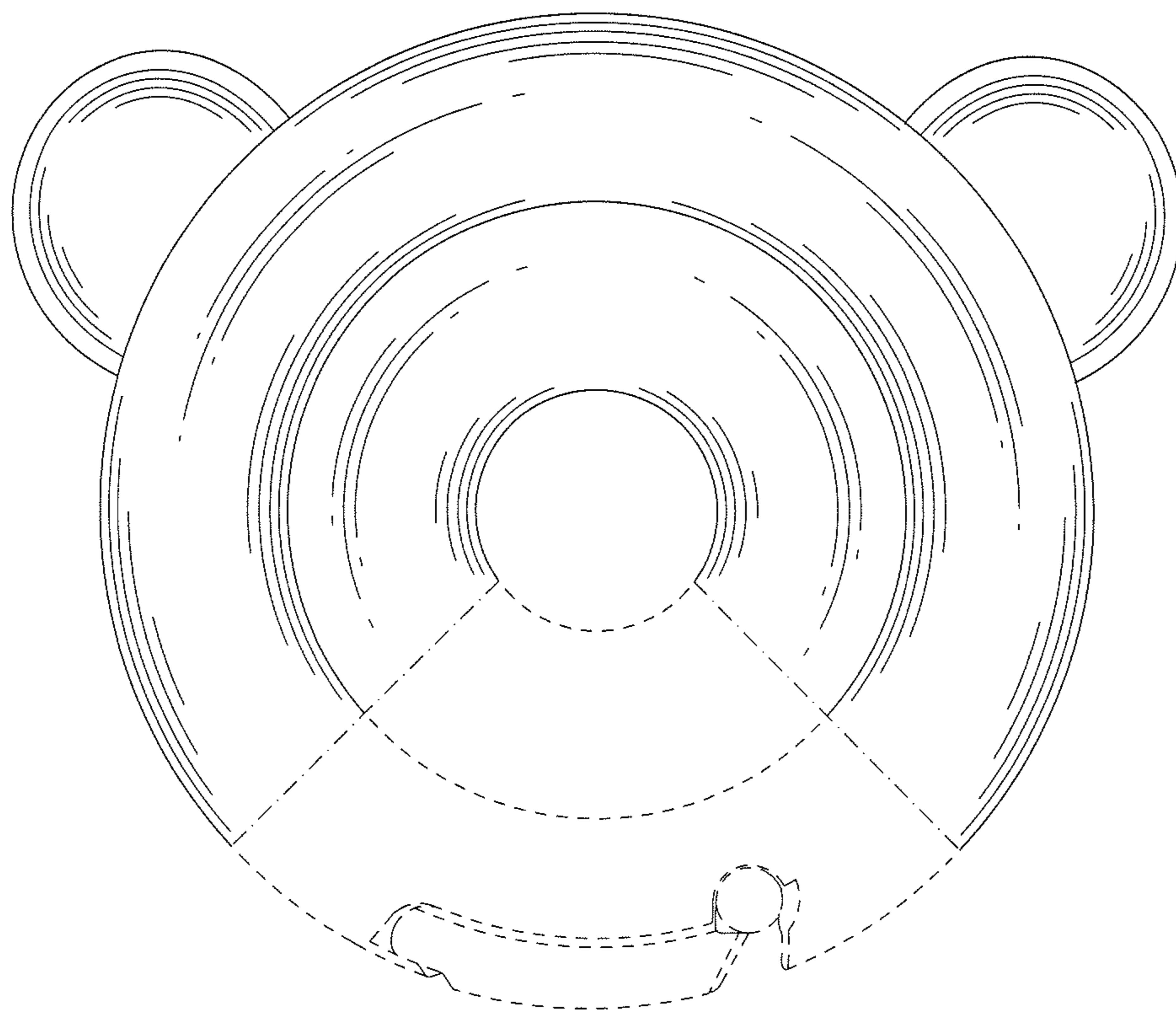

FIG. 3

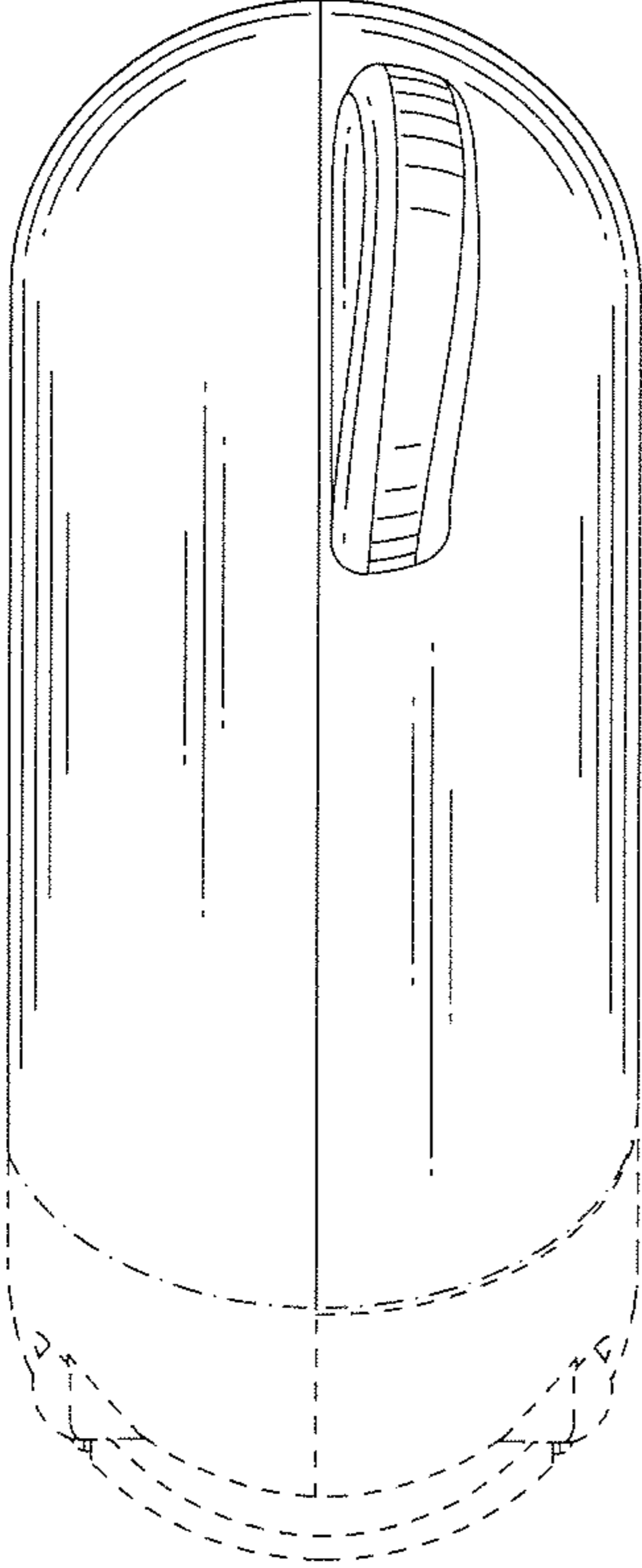

FIG. 4

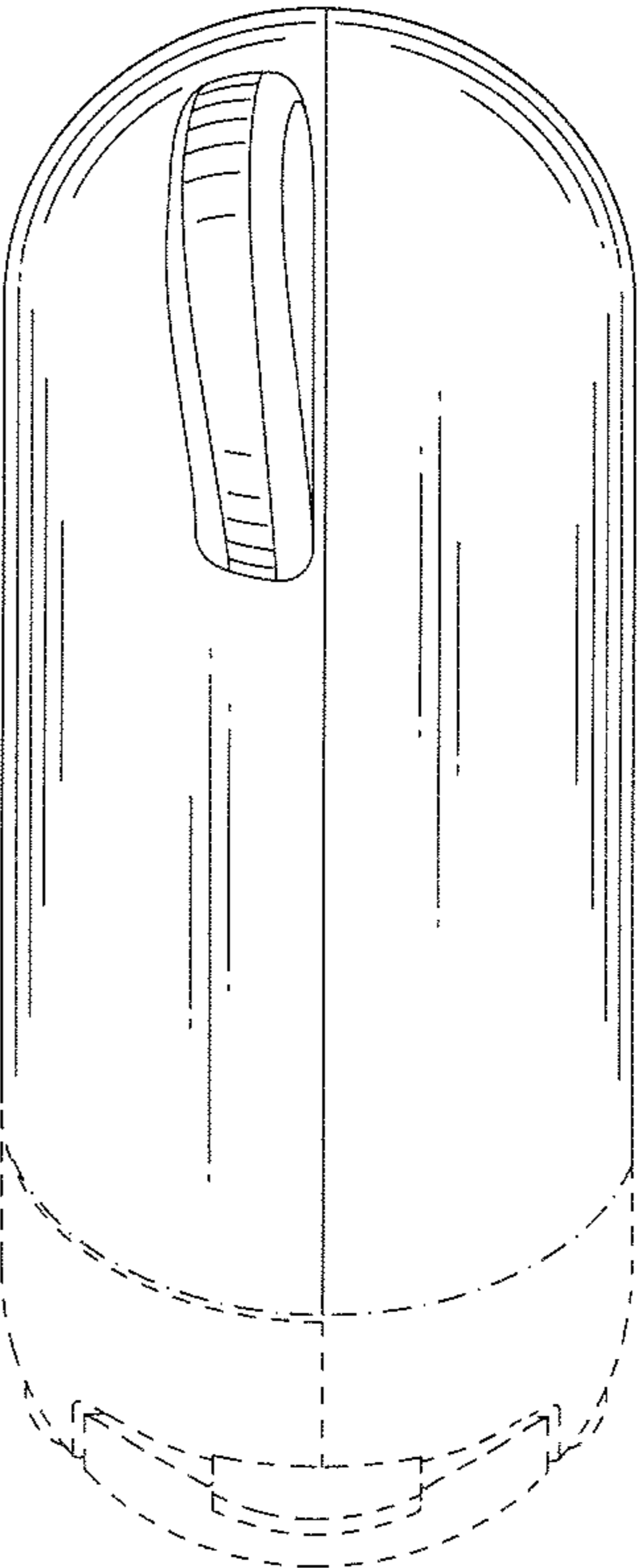

FIG. 5

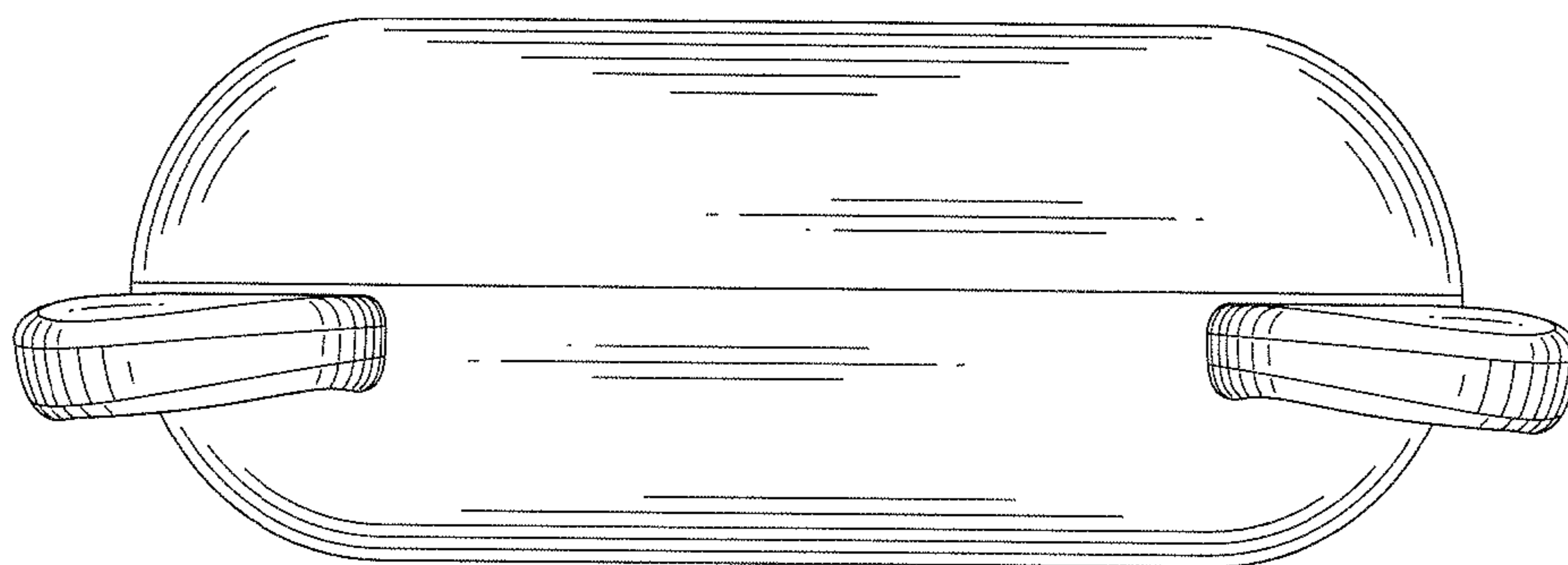

FIG. 6

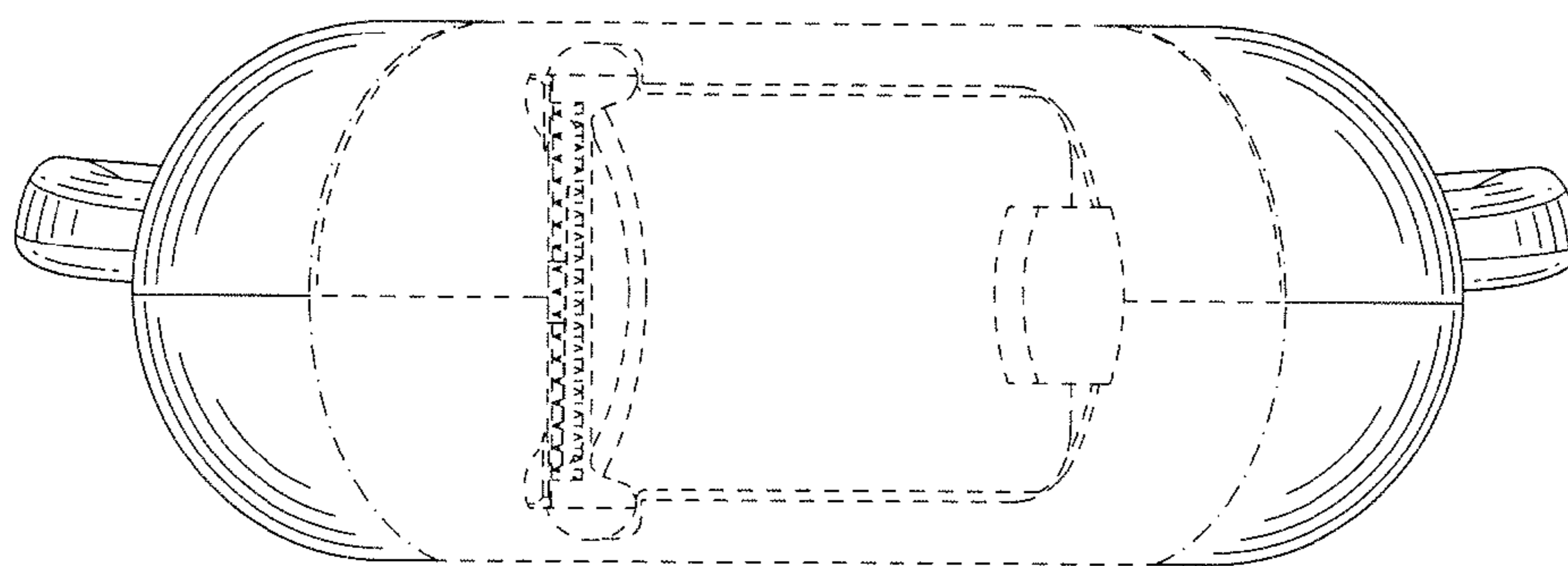

FIG. 7