

US00D756427S

(12) **United States Design Patent**
Ogg

(10) **Patent No.:** **US D756,427 S**

(45) **Date of Patent:** **** May 17, 2016**

(54) **HANDLE FOR REFRIGERATOR**

(71) Applicant: **LG ELECTRONICS INC.**, Seoul (KR)

(72) Inventor: **Anthony Ogg**, Edgewater, NJ (US)

(73) Assignee: **LG ELECTRONICS INC.**, Seoul (KR)

(**) Term: **14 Years**

(21) Appl. No.: **29/514,834**

(22) Filed: **Jan. 16, 2015**

(51) **LOC (10) Cl.** **15-07**

(52) **U.S. Cl.**
USPC **D15/89**

(58) **Field of Classification Search**
USPC D15/79-91; D7/340, 393, 394;
D8/300-302, 305, 313-331
CPC F25B 21/02; F25B 21/04; F25B 29/00;
F25B 2321/025; F25B 2321/0251; F25B
2339/047; F25B 2400/22; F25B 2700/2117;
F25B 1/00; F25B 1/10; F25B 2309/061;
F25B 2321/02; F25B 2347/021; F25B
2400/0411; F25B 2400/06; F25D 23/028;
F25D 23/02; F25D 25/025; F25D 23/00;
F25D 2323/021; F25D 11/00; F25D 23/04;
F25D 25/02; F25D 23/021; F25D 23/067;
F25D 25/024; F25D 17/042; F25D 2323/024;
F25D 23/065; A47F 3/0482; A47F 3/04;
A47F 3/0434; A47F 3/0447; A47F 3/0408;
A47F 3/0404; A47F 3/043; A47F 3/0443;
A47F 3/0486; A47F 3/0491; A47F 3/0469;
A47F 10/06; A47F 3/0426; A47F 3/0439;
A47F 11/10; A47F 3/001

See application file for complete search history.

(56) **References Cited**

U.S. PATENT DOCUMENTS

D556,794	S	*	12/2007	Vaughn	D15/89
D562,361	S	*	2/2008	Kwak	D15/89
D587,730	S	*	3/2009	Yang	D15/89
D588,172	S	*	3/2009	Yang	D15/89
D734,786	S	*	7/2015	Derry	D15/91

* cited by examiner

Primary Examiner — Daniel Bui

Assistant Examiner — Khawaja Anwar

(74) *Attorney, Agent, or Firm* — Birch, Stewart, Kolasch & Birch, LLP

(57) **CLAIM**

I claim the ornamental design for a handle for refrigerator, as shown and described.

DESCRIPTION

FIG. 1 is a perspective view of a handle for refrigerator showing my new design;
FIG. 2 is a front elevation view thereof;
FIG. 3 is a rear elevation view thereof;
FIG. 4 is a left-side elevation view thereof;
FIG. 5 is a right-side elevation view thereof;
FIG. 6 is a top plan view thereof;
FIG. 7 is a bottom plan view thereof;
FIG. 8 is a perspective view thereof, shown in condition of use; and,
FIG. 9 is an exploded view thereof, shown in condition of use.
The broken lines in the drawing figures are included for the purpose of illustrating environment and form no part of the claimed design.

1 Claim, 6 Drawing Sheets

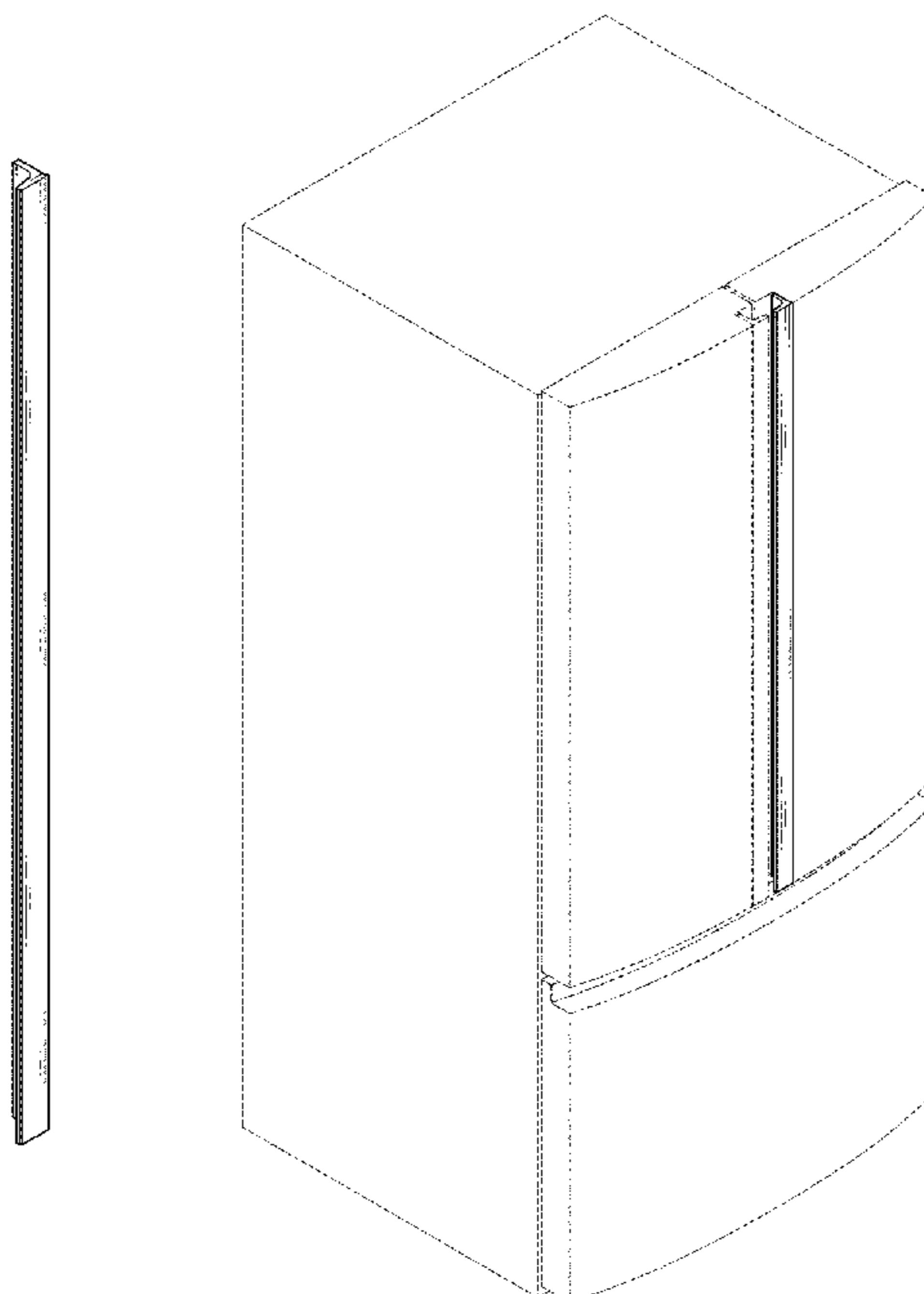

FIG. 1

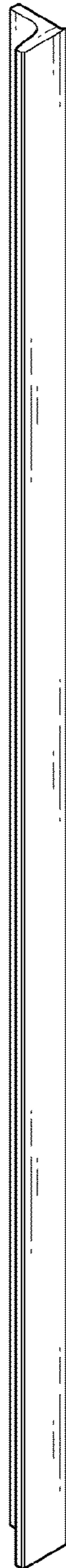

FIG.2

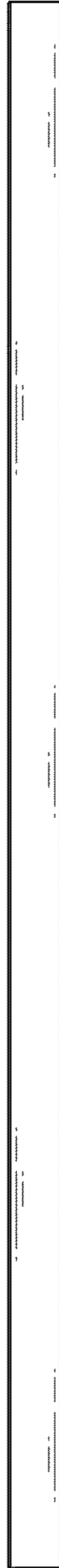

FIG.3



FIG. 4

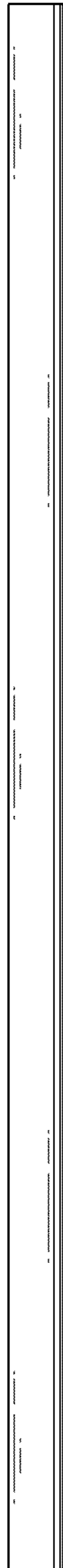

FIG. 5

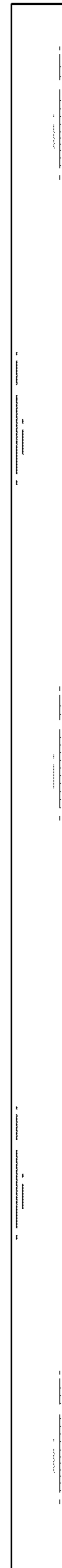

FIG. 6



FIG. 7

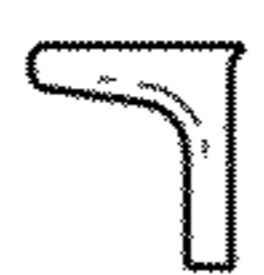

FIG. 8

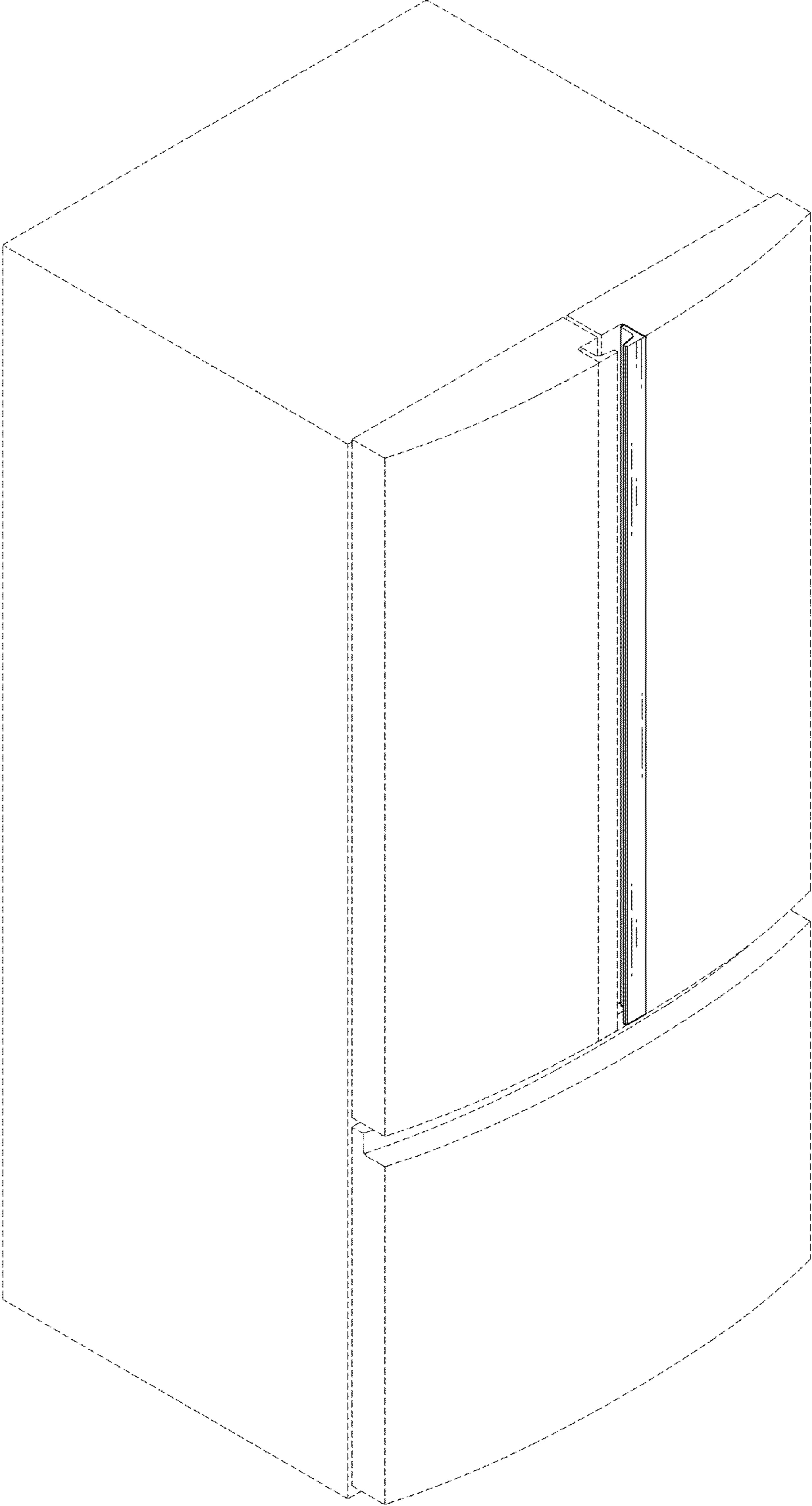

FIG. 9

