



US00D756331S

(12) **United States Design Patent**
Kamlet et al.

(10) **Patent No.:** **US D756,331 S**
(45) **Date of Patent:** **** May 17, 2016**

(54) **LOUDSPEAKER**

(71) Applicant: **Harman International Industries, Incorporated**, Northridge, CA (US)

(72) Inventors: **Rick Kamlet**, Los Angeles, CA (US);
Myk Wayne Lum, Irvine, CA (US)

(73) Assignee: **Harman International Industries, Incorporated**, Northridge, CA (US)

(**) Term: **14 Years**

(21) Appl. No.: **29/514,741**

(22) Filed: **Jan. 15, 2015**

(51) **LOC (10) Cl.** **14-03**

(52) **U.S. Cl.**
USPC **D14/214**

(58) **Field of Classification Search**

USPC D14/168, 170–172, 188, 194–196, 204,
D14/207, 210–216, 219, 221, 222, 224,
D14/496; 181/143, 144, 147, 148, 150, 153,
181/157, 198, 199; 381/300–303, 306, 332,
381/333, 336, 345, 361–364, 386–388
CPC B60R 11/0217; G06F 1/1688; H04M 1/03;
H04M 1/035; H04R 1/02; H04R 1/06; H04R
1/021; H04R 1/025; H04R 1/026; H04R
1/028; H04R 1/105; H04R 1/323; H04R
1/403; H04R 1/2803; H04R 1/2834; H04R
5/02; H04R 7/20; H04R 9/06; H04R 9/025;
H04R 2201/021; H04R 2400/00; H04R
2400/07; H04R 2499/11; H04R 2499/13;
H04R 2499/15; H04S 3/00; H04S 7/30

See application file for complete search history.

(56) **References Cited**

U.S. PATENT DOCUMENTS

D381,335 S * 7/1997 Whitehead D14/204
D394,263 S * 5/1998 Fischer D14/214

D439,237 S * 3/2001 Felix D14/214
D503,703 S * 4/2005 Beckett D14/214
D568,293 S * 5/2008 Sawhney D14/214
D568,294 S * 5/2008 Sawhney D14/214
D609,214 S * 2/2010 Hussey D14/214
D609,216 S * 2/2010 Davies D14/214
D642,555 S * 8/2011 Hawkins D14/214
D644,627 S * 9/2011 Garrett D14/214
D655,691 S * 3/2012 Stewart, Jr. D14/214
D660,286 S * 5/2012 Lee D14/214
D695,269 S * 12/2013 Carpenter D14/209.1
D733,680 S * 7/2015 Nugent D14/214

* cited by examiner

Primary Examiner — Keli L Hill

(74) *Attorney, Agent, or Firm* — Plumsea Law Group, LLC

(57) **CLAIM**

The ornamental design for a loudspeaker, as shown and described.

DESCRIPTION

FIG. 1 is a perspective view of a loudspeaker showing our new design;
FIG. 2 is a rear perspective view thereof;
FIG. 3 is a front elevational view thereof;
FIG. 4 is a rear elevational view thereof;
FIG. 5 is a side elevational view thereof, the opposite side elevational view being a mirror image;
FIG. 6 is a top plan view thereof;
FIG. 7 is a perspective view of another embodiment of the loudspeaker showing our new design;
FIG. 8 is a rear perspective view thereof;
FIG. 9 is a front elevational view thereof;
FIG. 10 is a rear elevational view thereof;
FIG. 11 is a side elevational view thereof, the opposite side elevational view being a mirror image; and,
FIG. 12 is a top plan view thereof.
The broken line showings form no part of the claimed design.

1 Claim, 12 Drawing Sheets

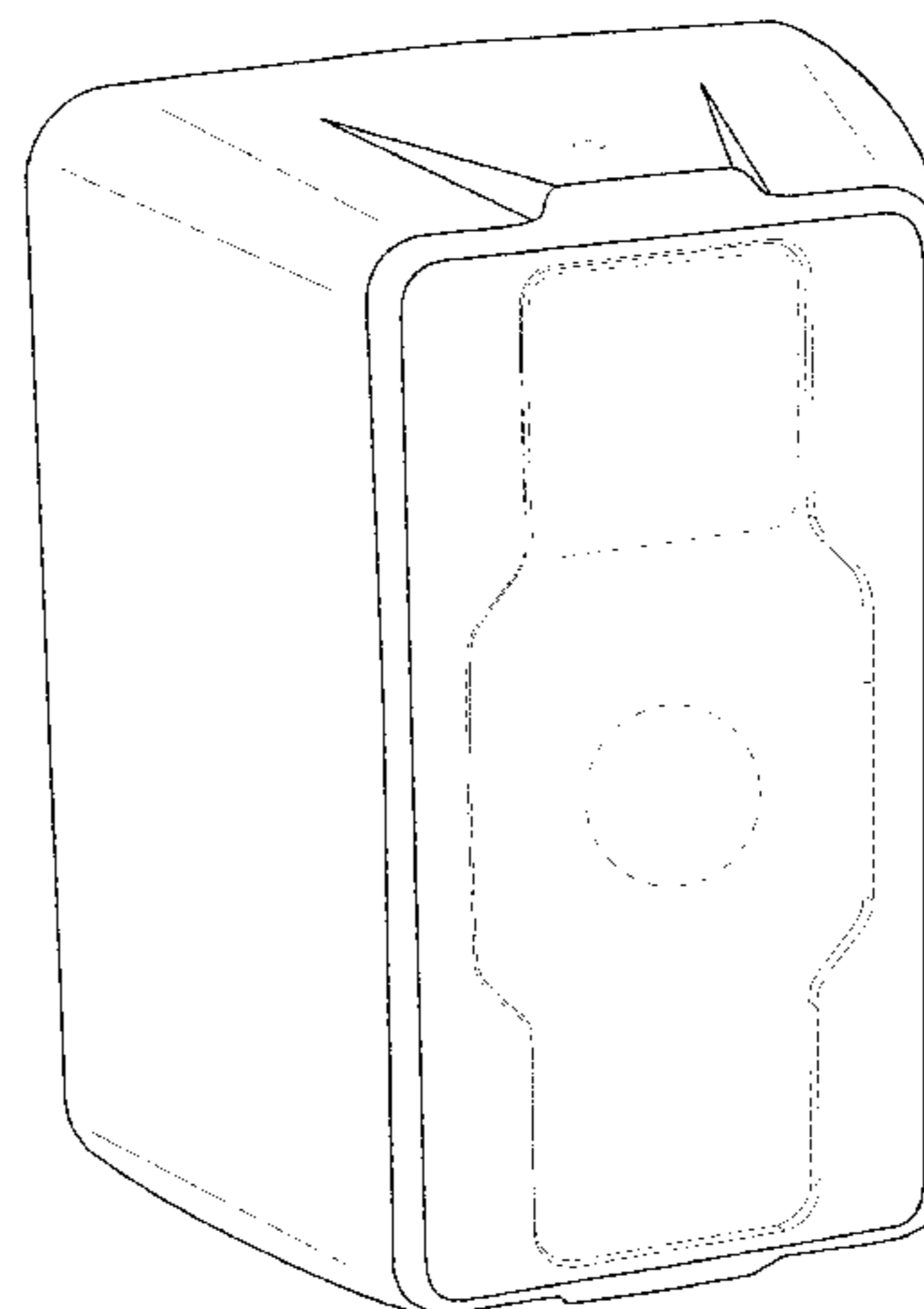
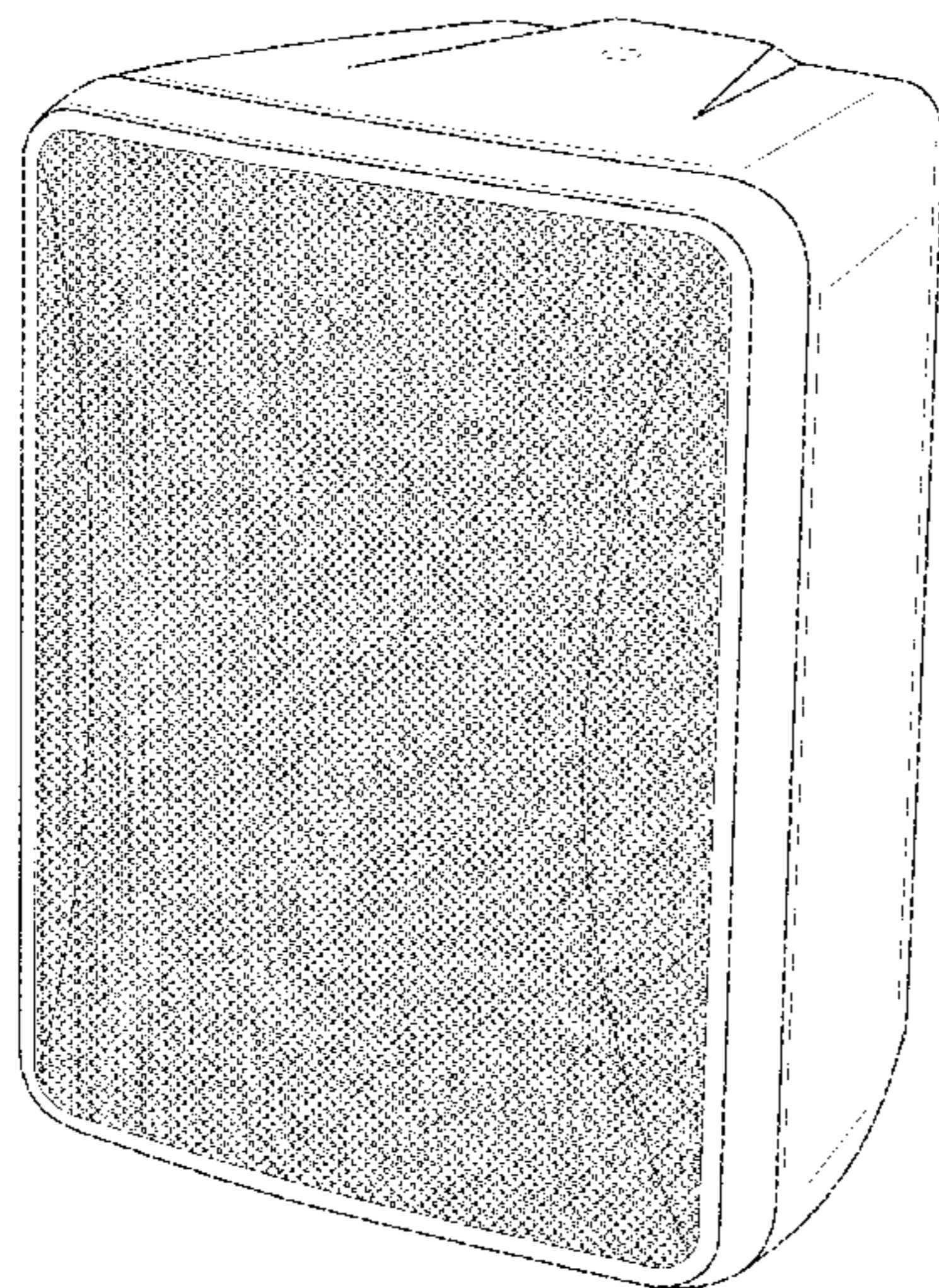

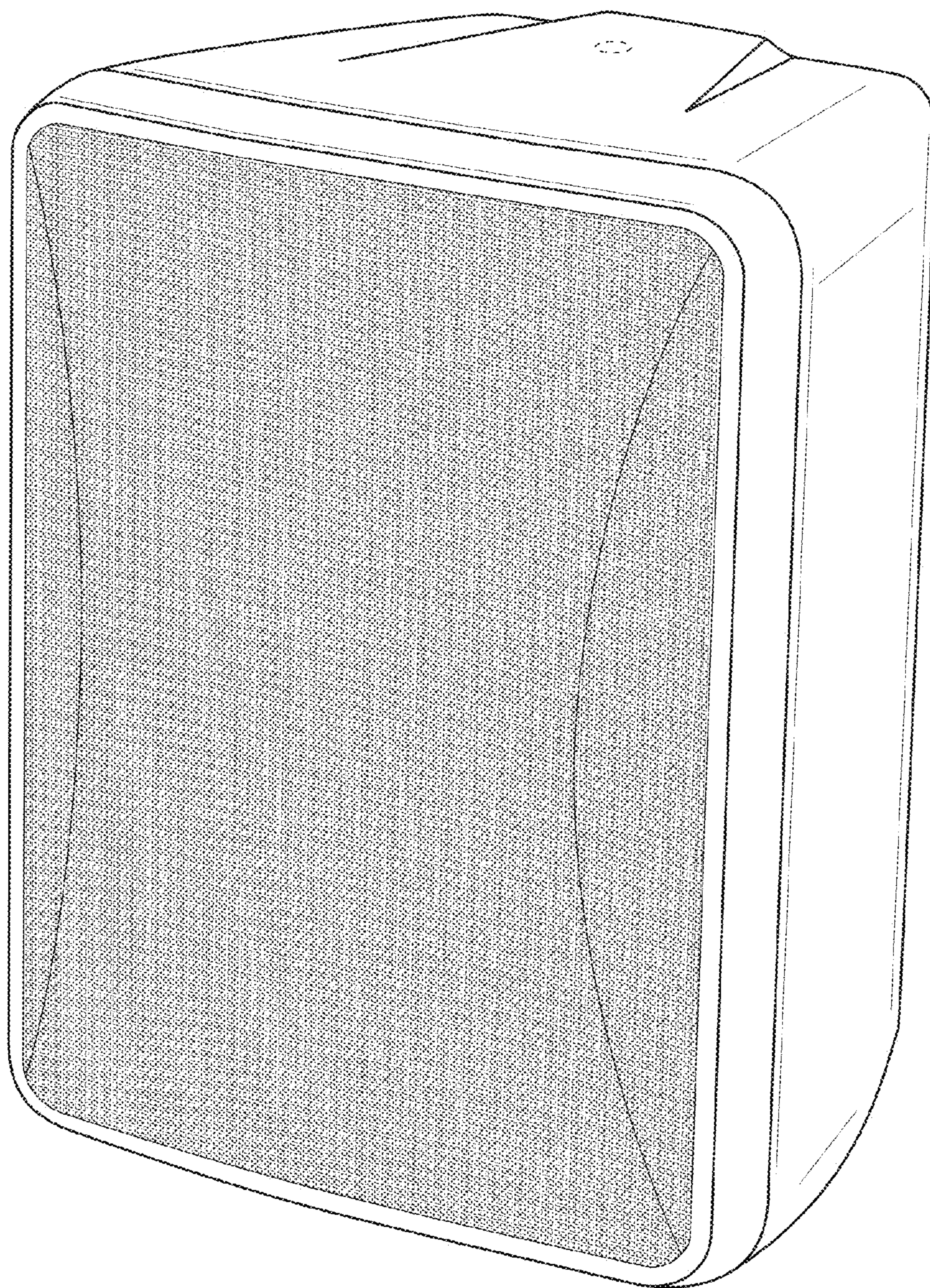

Fig. 1

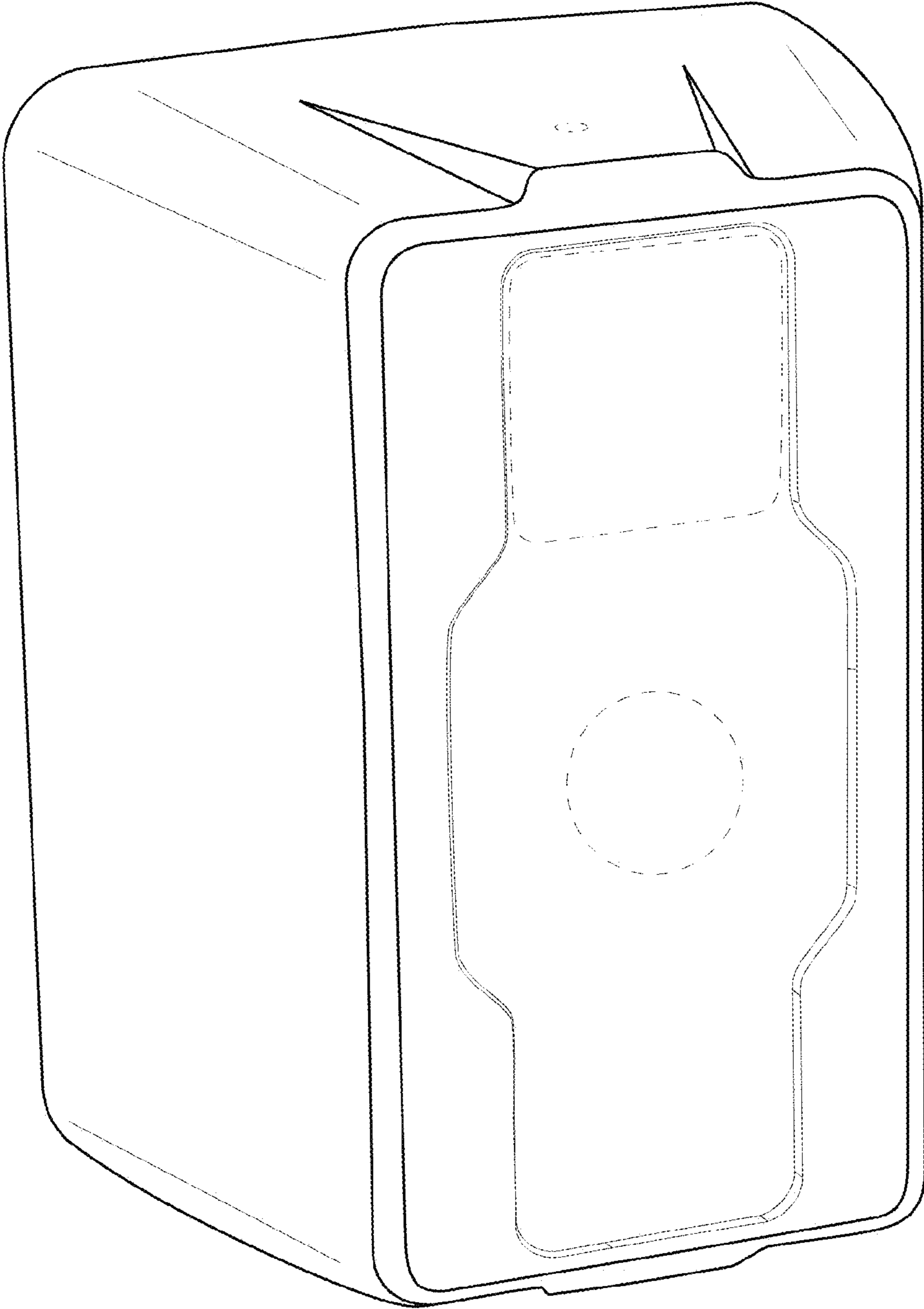

Fig. 2

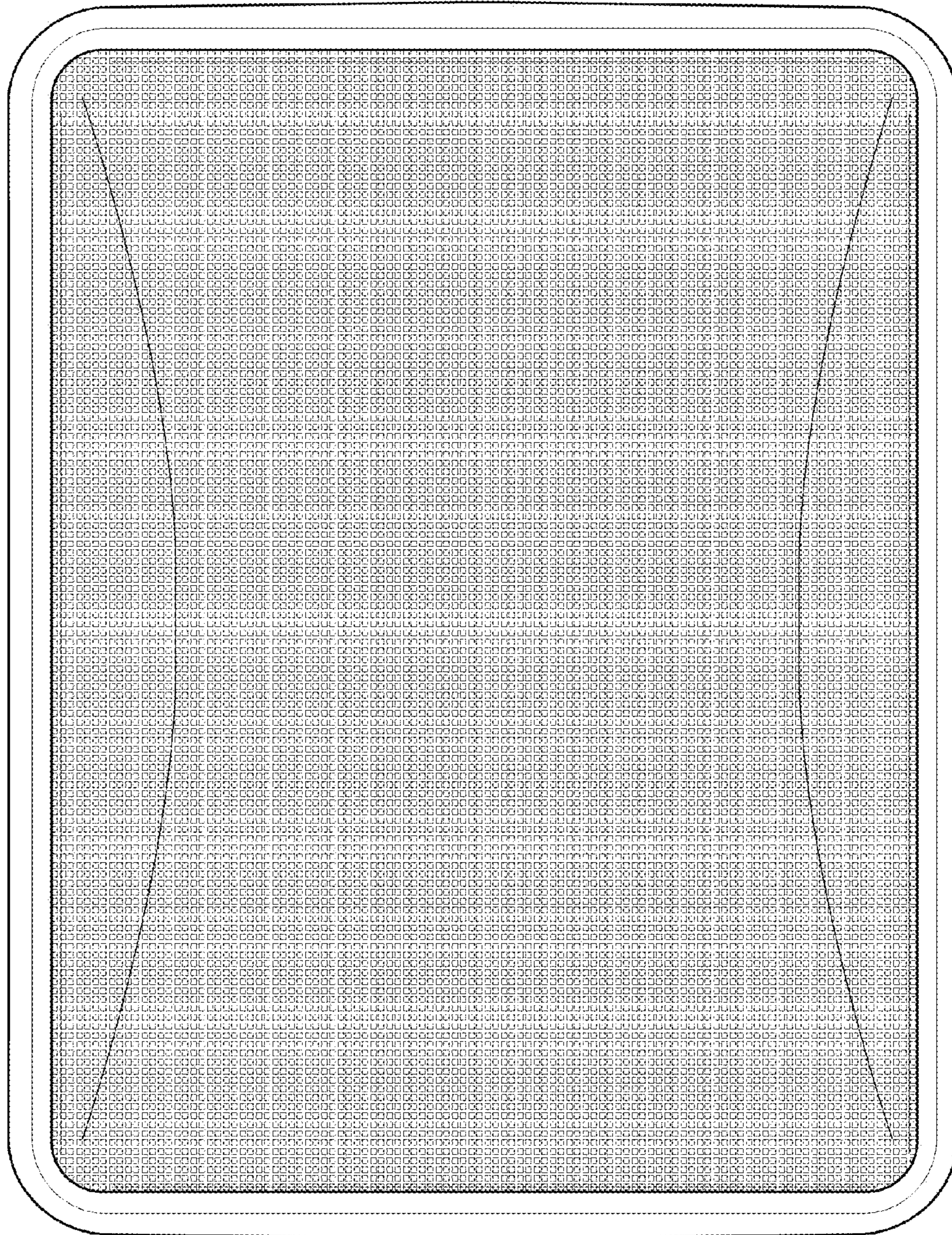

Fig. 3

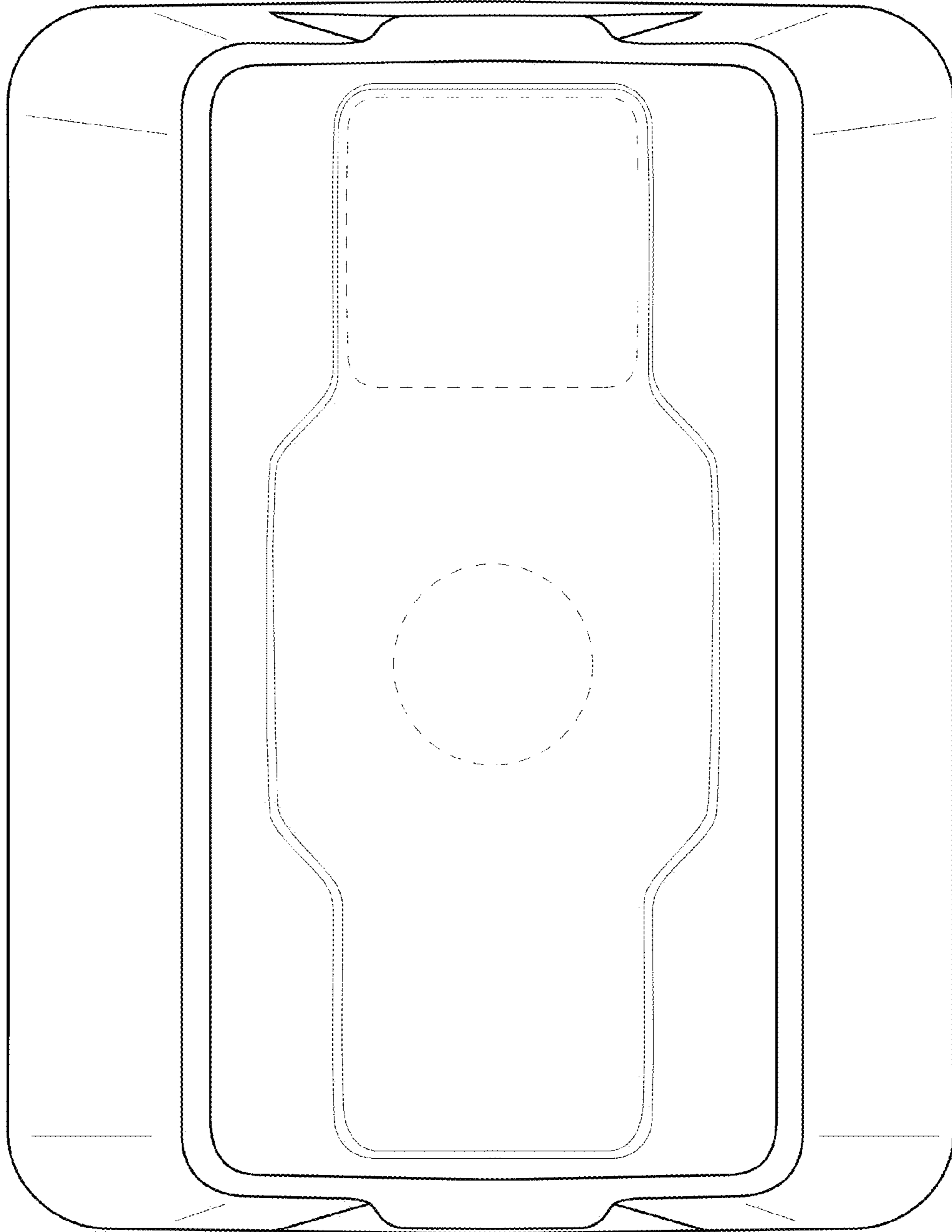

Fig. 4

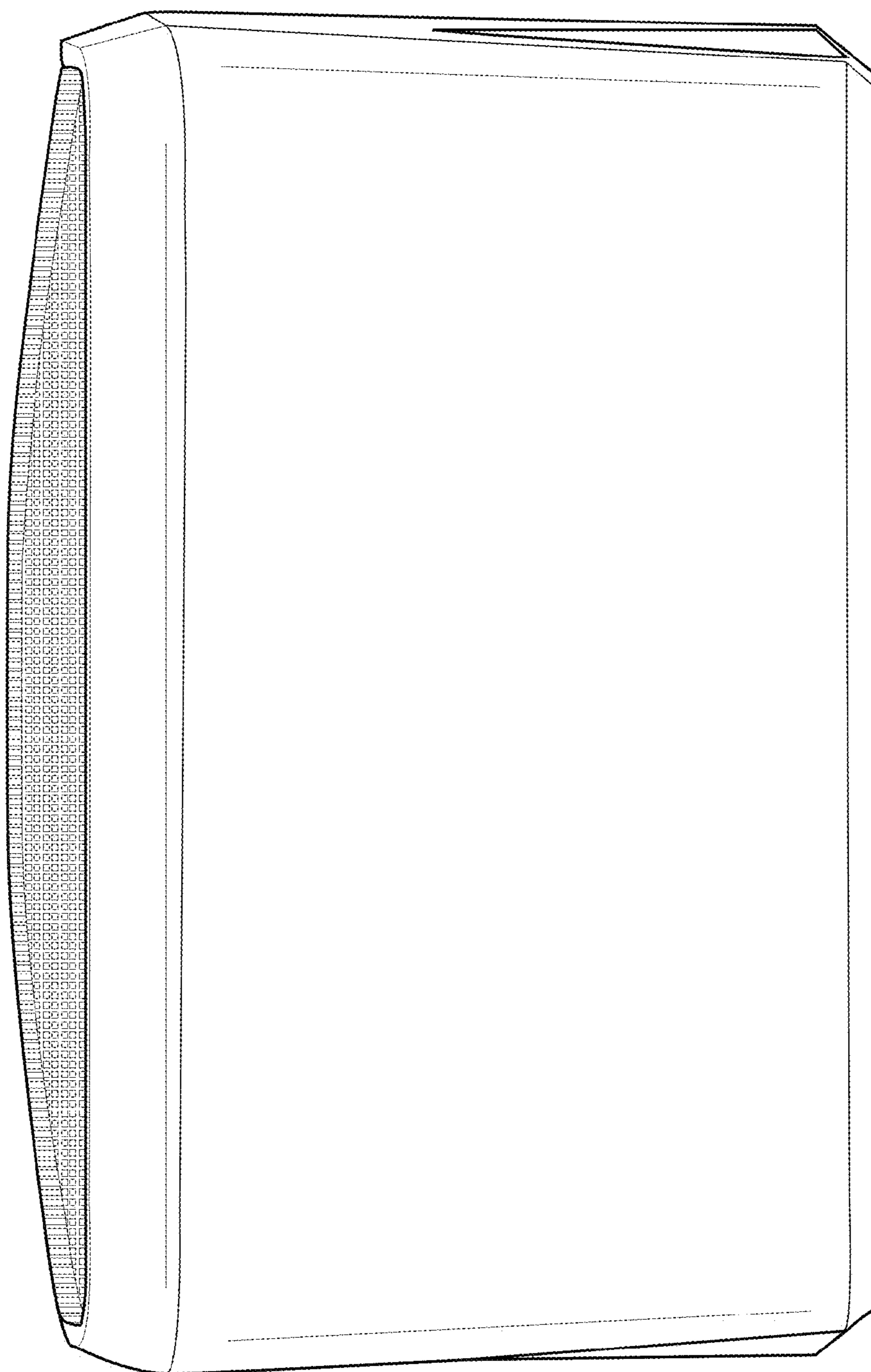

Fig. 5

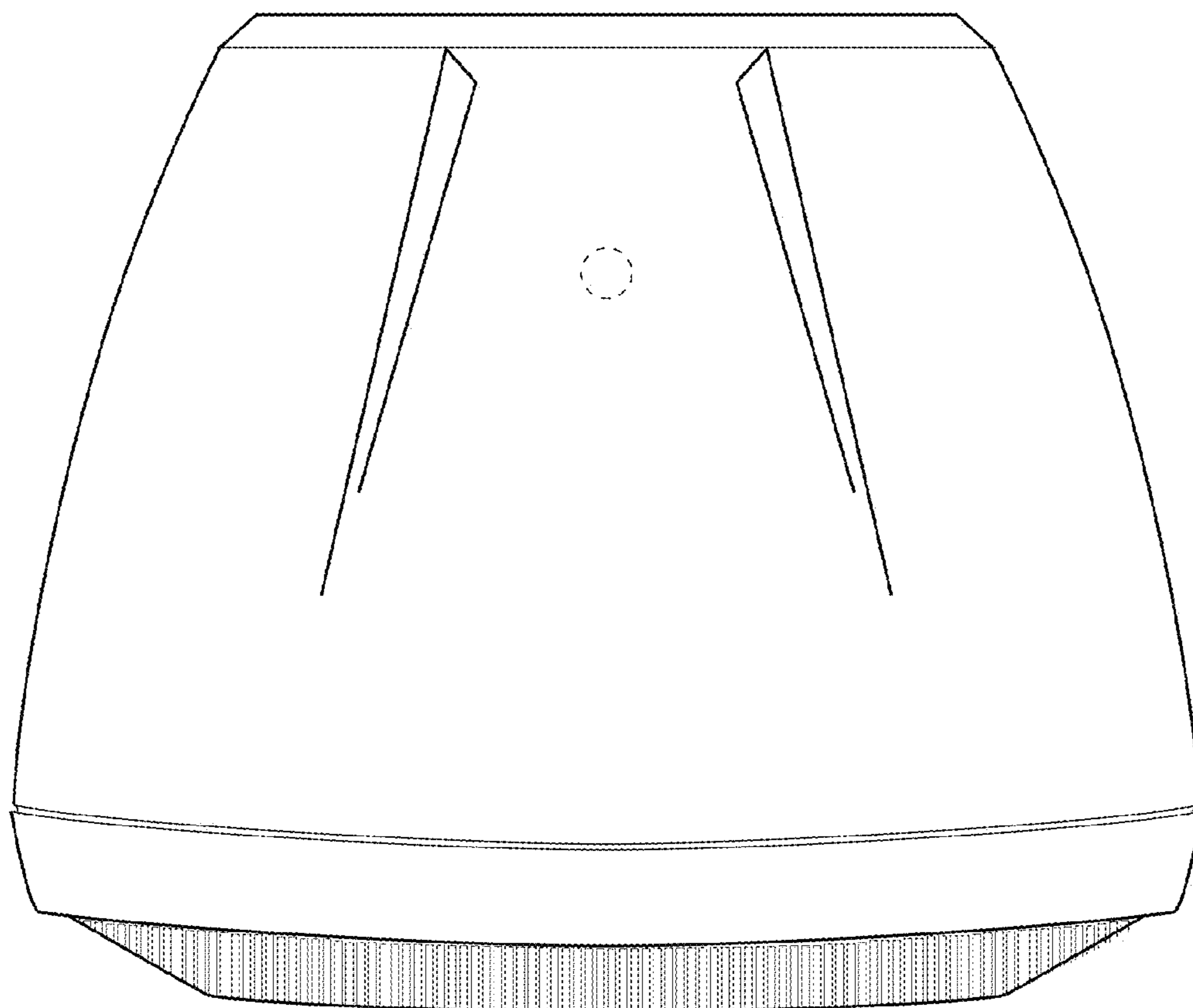

Fig. 6

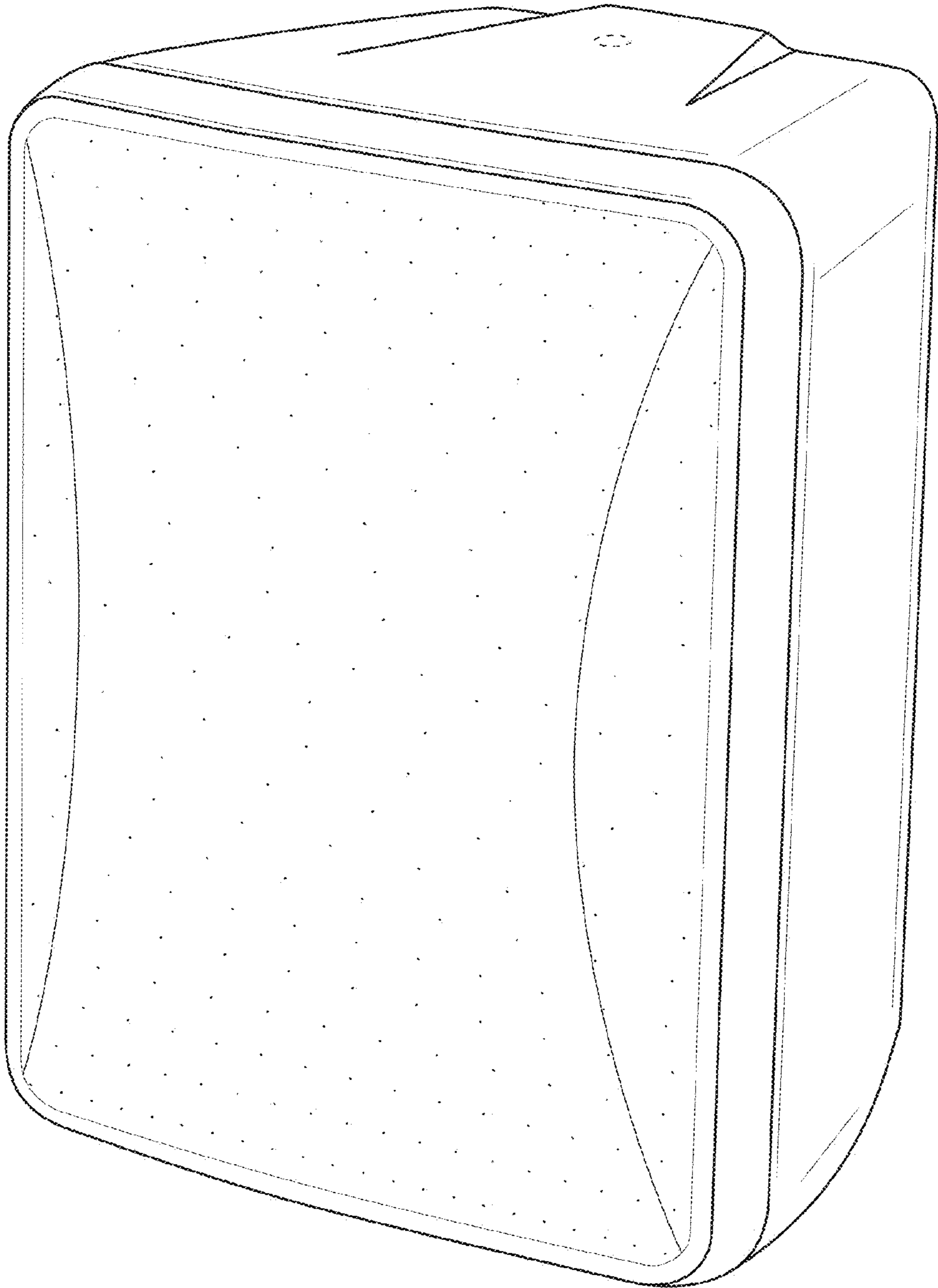

Fig. 7

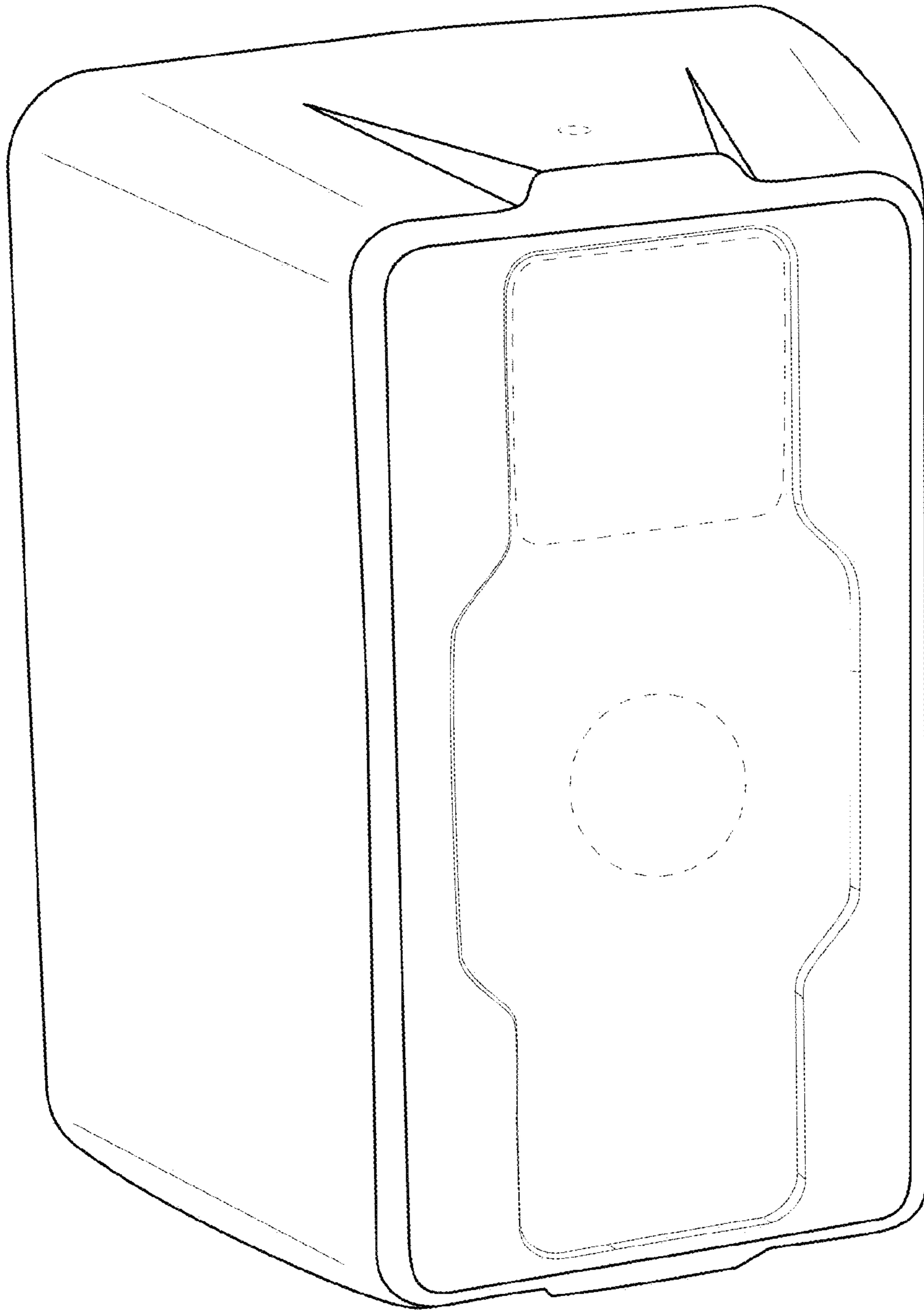

Fig. 8

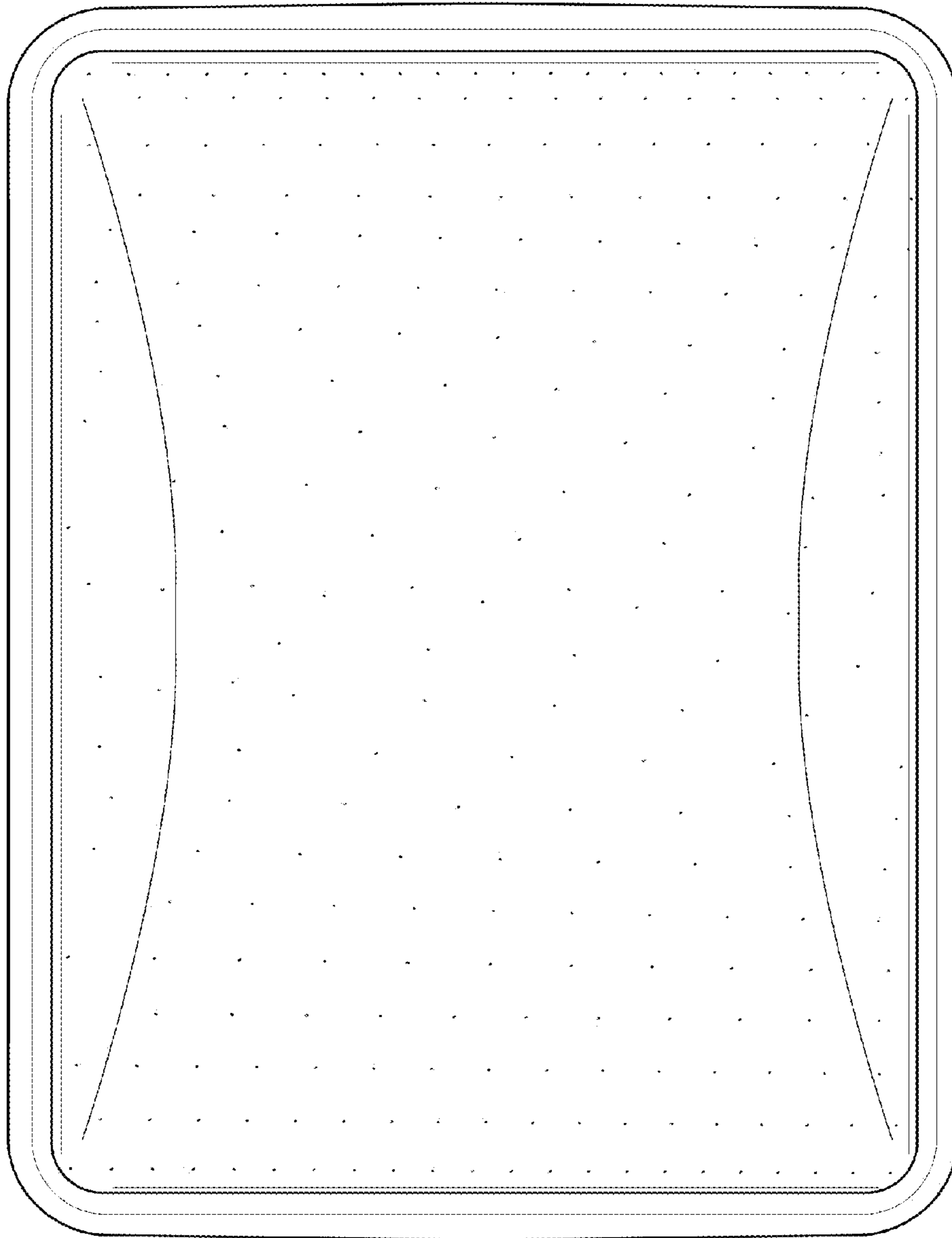

Fig. 9

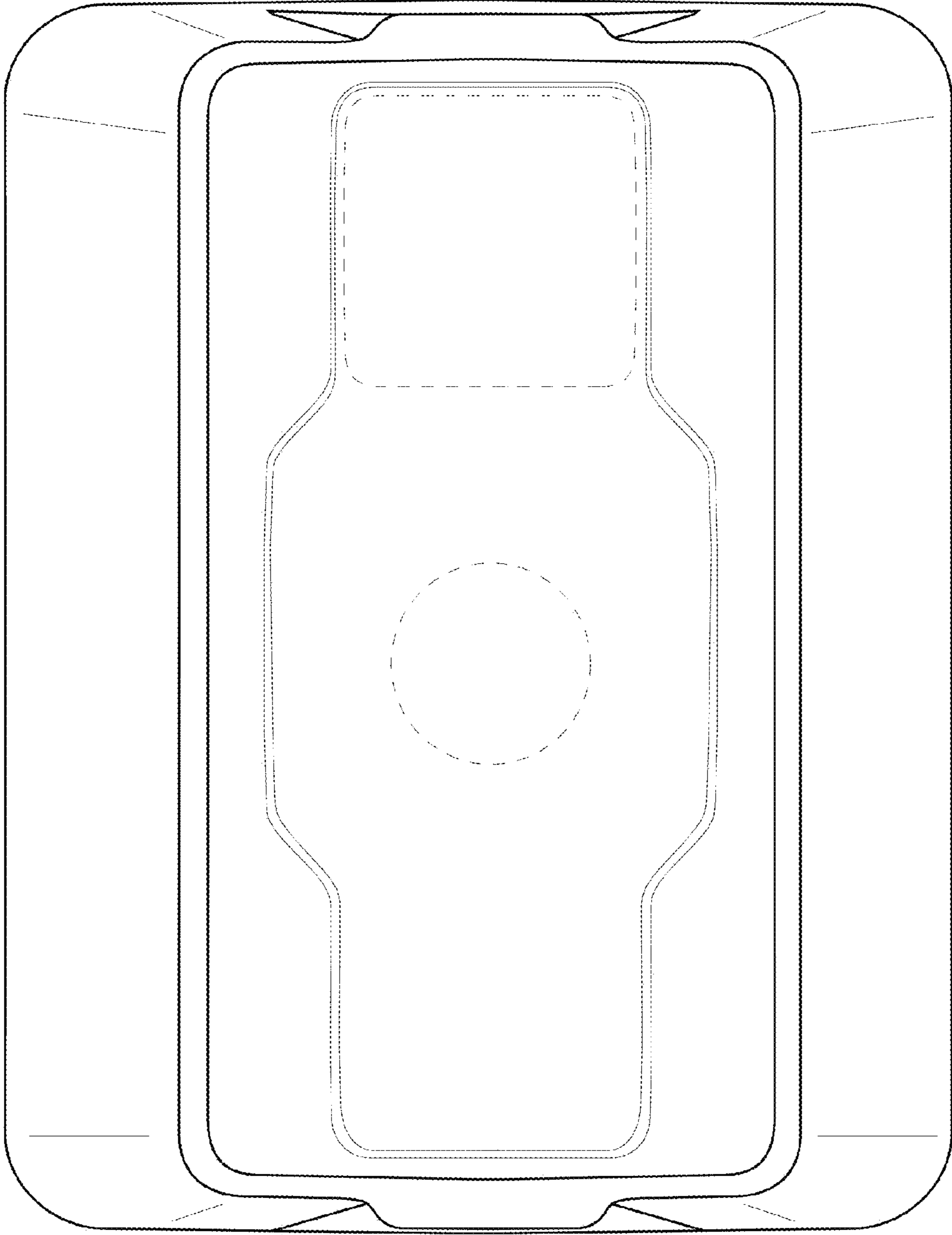

Fig. 10

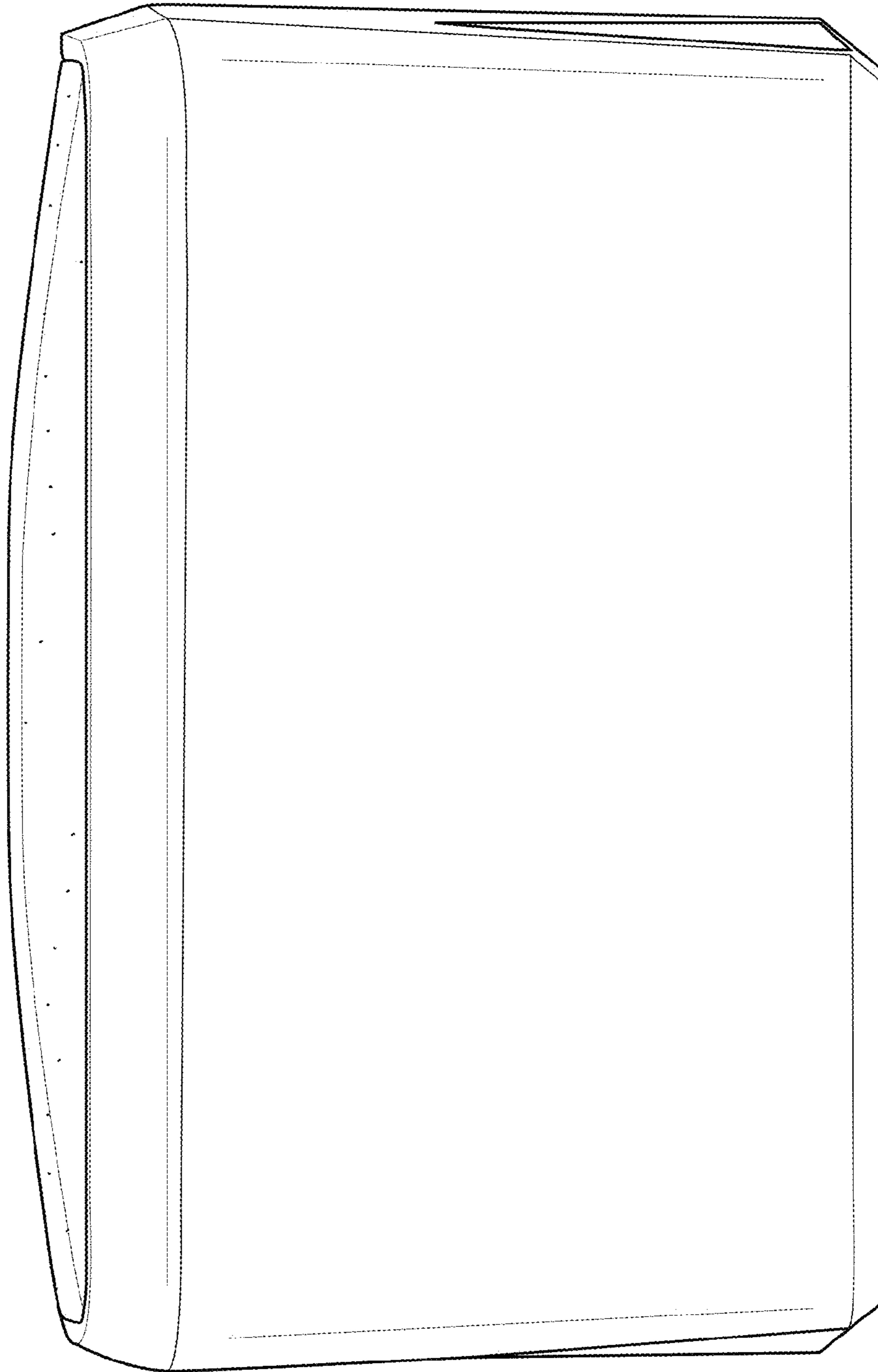

Fig. 11

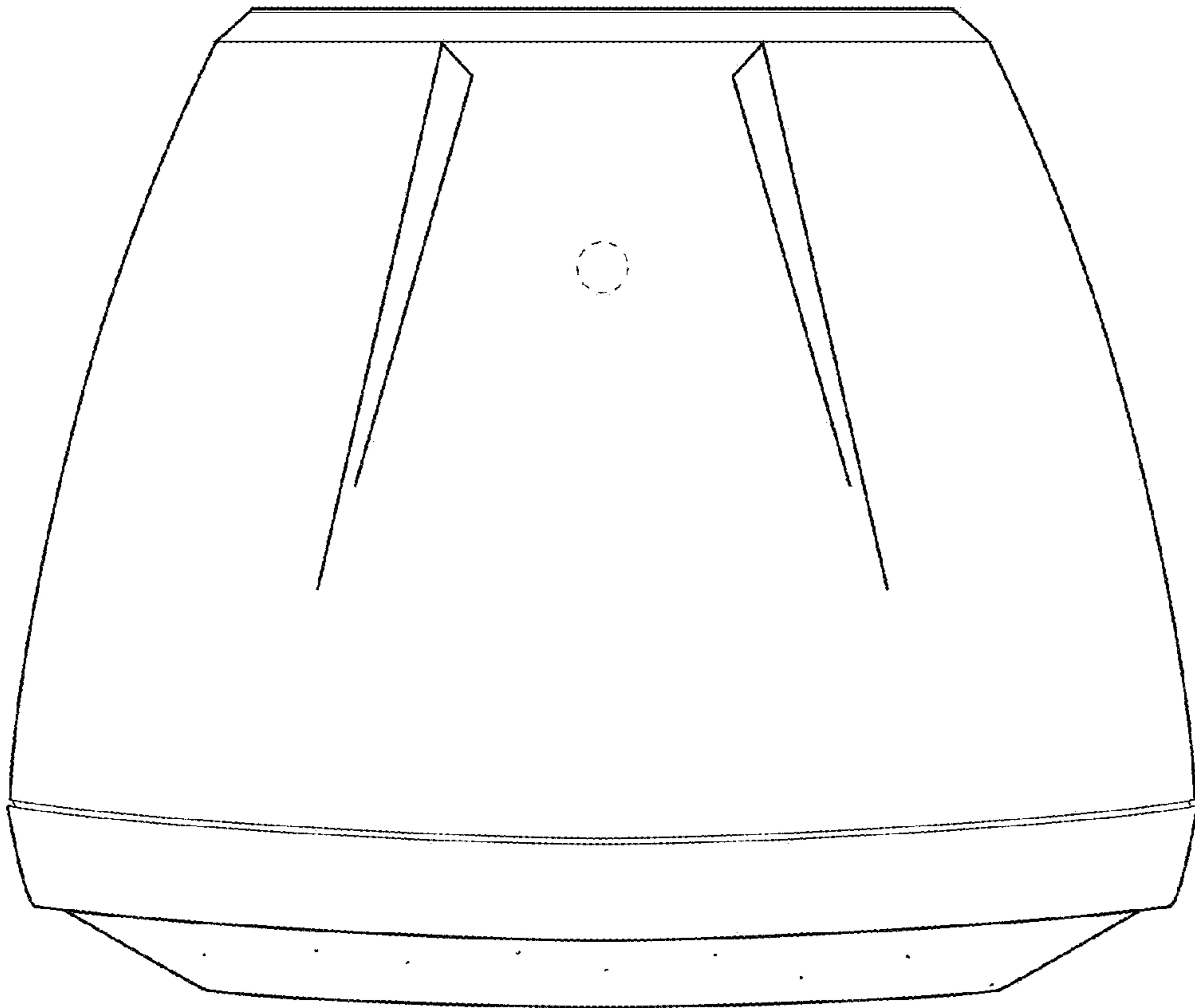

Fig. 12