



US00D756159S

(12) **United States Design Patent**  
**Chang**

(10) **Patent No.:** **US D756,159 S**  
(45) **Date of Patent:** **\*\* May 17, 2016**

(54) **COUNTERTOP COOKER**  
(76) Inventor: **Peter Chang**, San Diego, CA (US)  
(\*\*) Term: **14 Years**  
(21) Appl. No.: **29/422,905**  
(22) Filed: **May 24, 2012**  
(51) **LOC (10) Cl.** ..... **07-02**  
(52) **U.S. Cl.**  
USPC ..... **D7/354**  
(58) **Field of Classification Search**  
USPC ..... D7/323, 329–332, 337, 346–347,  
D7/350.1–350.4, 353–367, 391–395,  
D7/402–406, 538, 542–543; 99/324–325,  
99/330–332, 337–340, 369, 400–418, 422,  
99/425, 444, 483; 126/37 R, 41 R, 261,  
126/378.1; 206/501–505, 507–508;  
219/400, 405, 429–442, 620–624, 725,  
219/730–735; 220/315, 573.1–573.5, 912;  
426/438, 441  
See application file for complete search history.

D341,058 S \* 11/1993 Slany et al. .... D7/360  
D345,485 S \* 3/1994 Leung ..... D7/360  
D345,886 S \* 4/1994 Gingele ..... D7/360  
D362,993 S \* 10/1995 Sarnoff et al. .... D7/360  
D369,505 S \* 5/1996 Philippe ..... D7/354  
D370,827 S \* 6/1996 Combe ..... D7/360  
D418,360 S \* 1/2000 Kei ..... D7/354  
D446,081 S \* 8/2001 Schulein ..... D7/543  
D549,517 S \* 8/2007 Moran ..... D7/358

\* cited by examiner

*Primary Examiner* — Ricky Pham

(57) **CLAIM**

The ornamental design for a countertop cooker, as shown and described.

**DESCRIPTION**

FIG. 1 is a front perspective view of the countertop cooker showing my new design;  
FIG. 2 is a front elevational view thereof  
FIG. 3 is a rear elevational view thereof, opposite the view of FIG. 2  
FIG. 4 is a first side elevational view thereof;  
FIG. 5 is a second side elevational view thereof opposite the view of FIG. 4;  
FIG. 6 is a top plan view thereof; and,  
FIG. 7 is a bottom view thereof opposite the view of FIG. 6.  
The portions of the cooker shown in dotted lines are not part of the countertop cooker design and do not form any portion of the present invention.

**1 Claim, 7 Drawing Sheets**

(56) **References Cited**

**U.S. PATENT DOCUMENTS**

D141,818 S \* 7/1945 Kendall ..... D7/358  
3,801,331 A \* 4/1974 Sano et al. .... 99/403  
D323,762 S \* 2/1992 Barrault ..... D7/354  
D323,954 S \* 2/1992 Barrault ..... D7/354

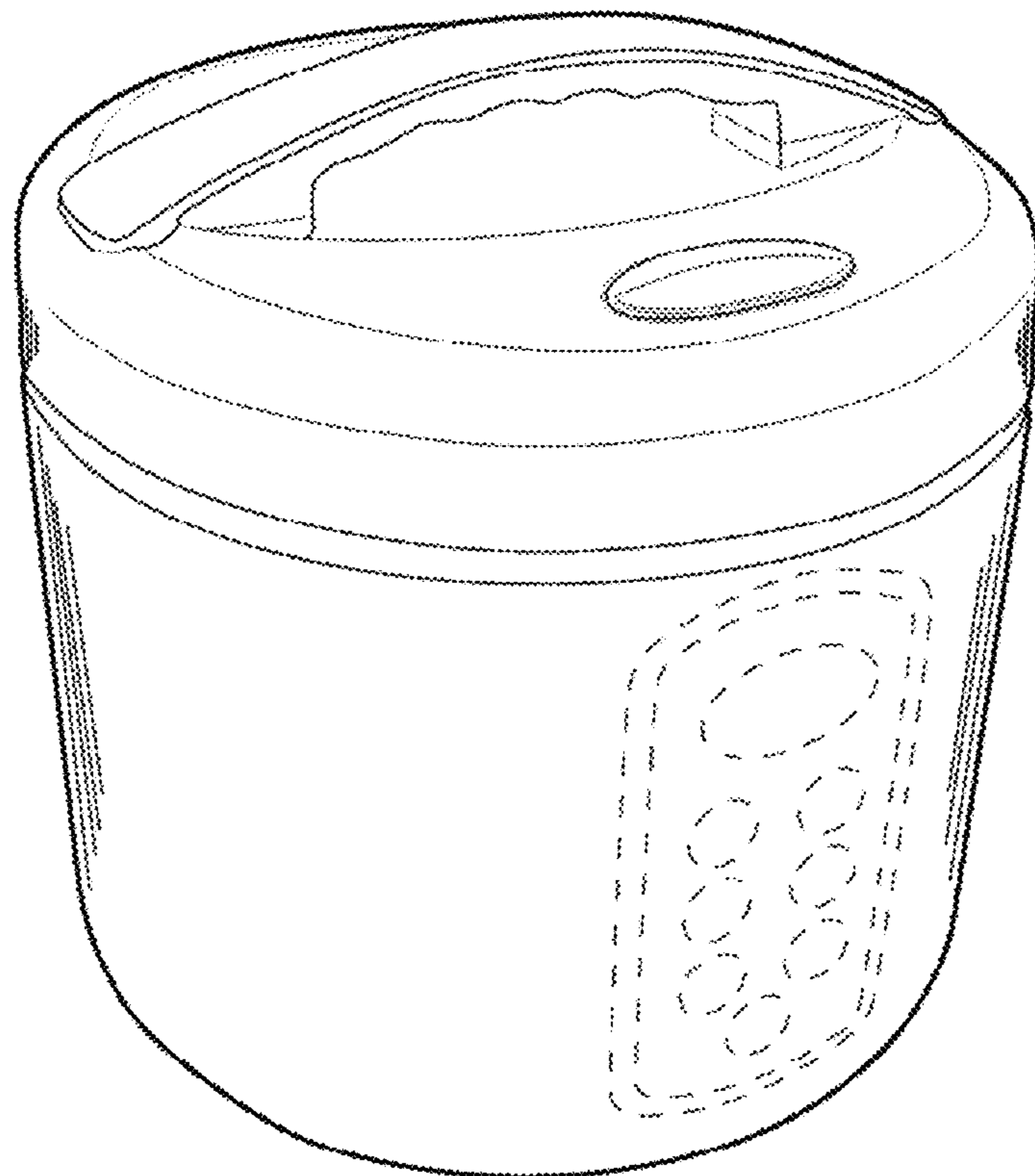

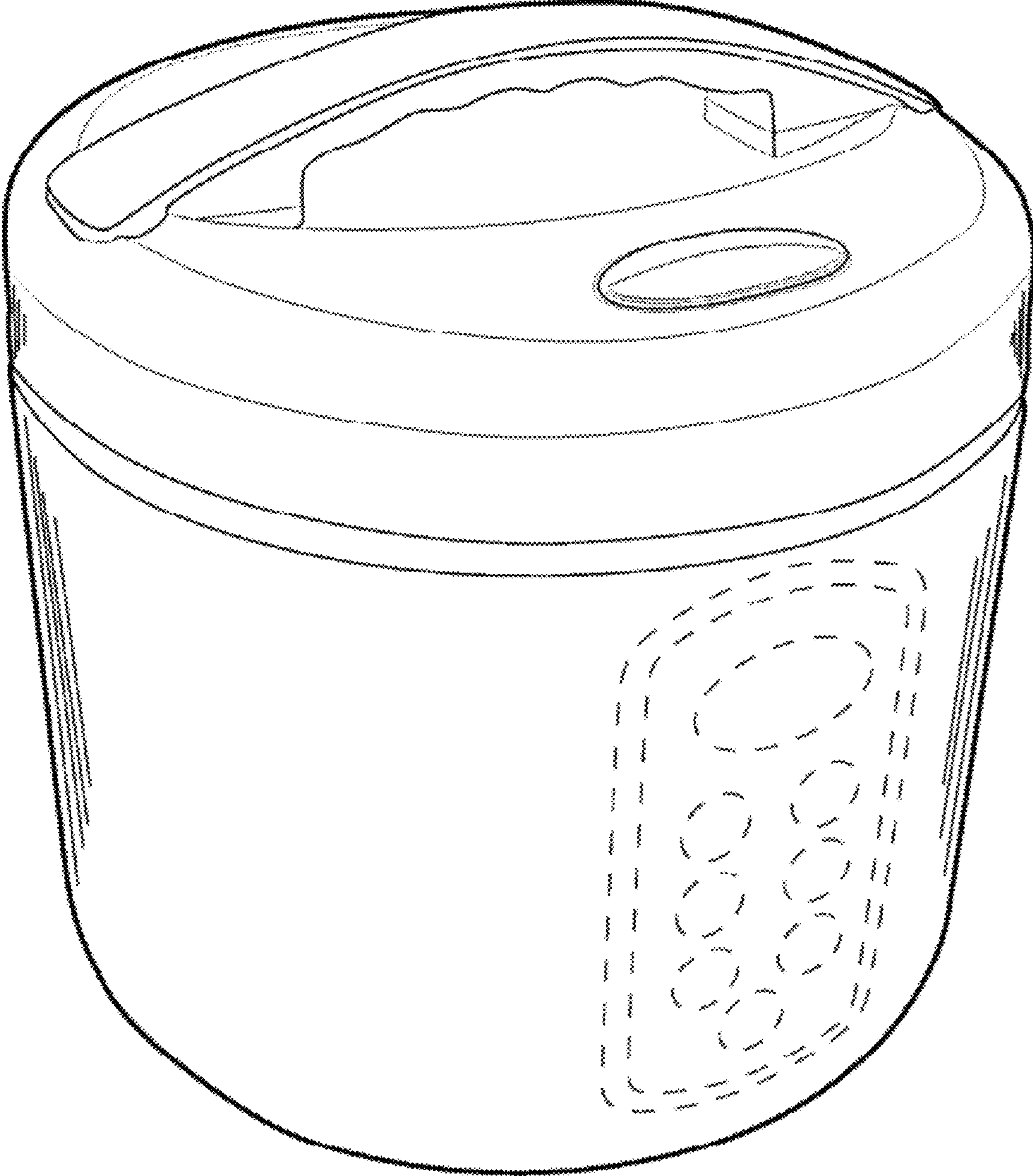

Fig. 1

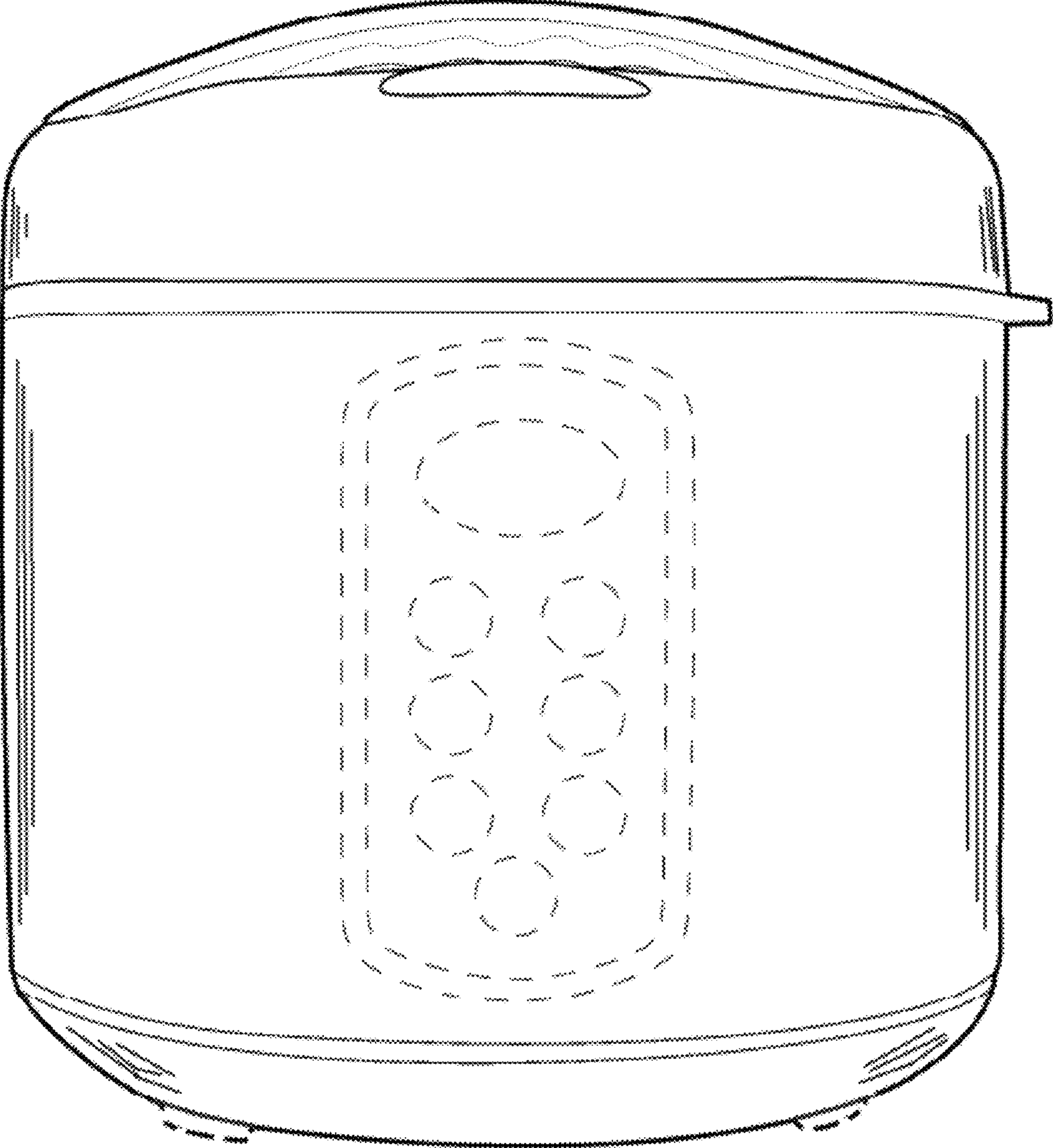

Fig. 2



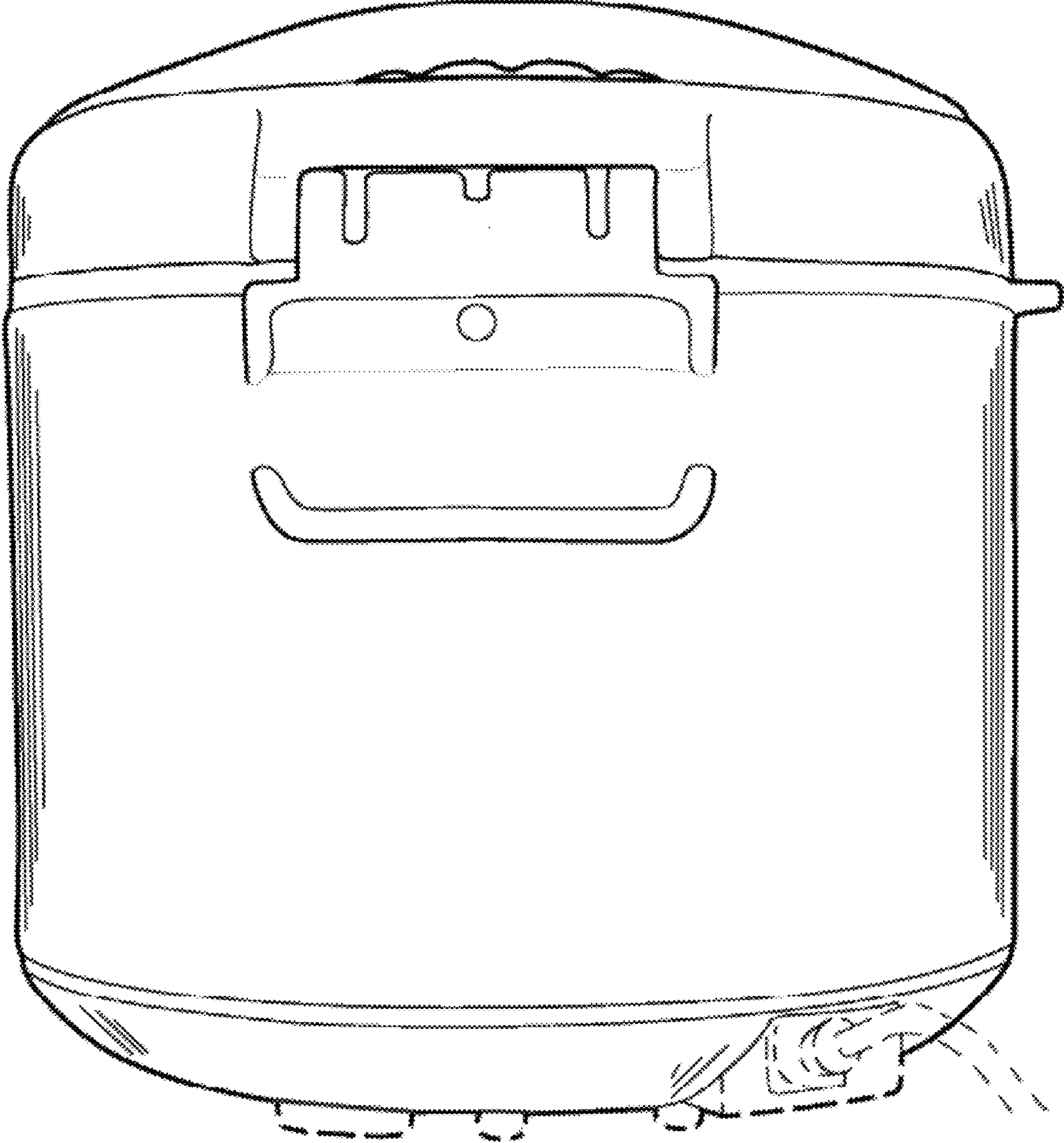

Fig. 3

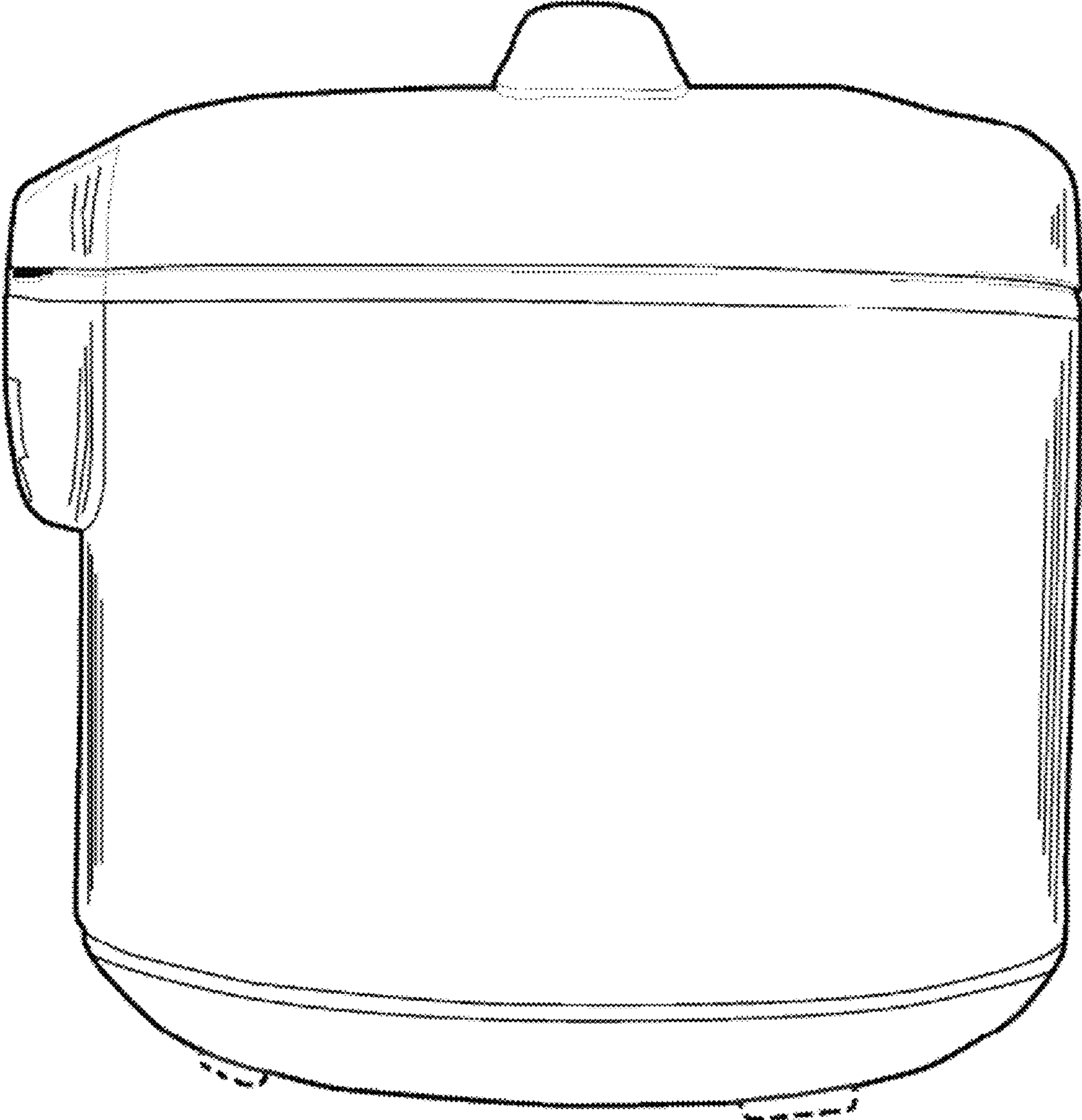

Fig. 4

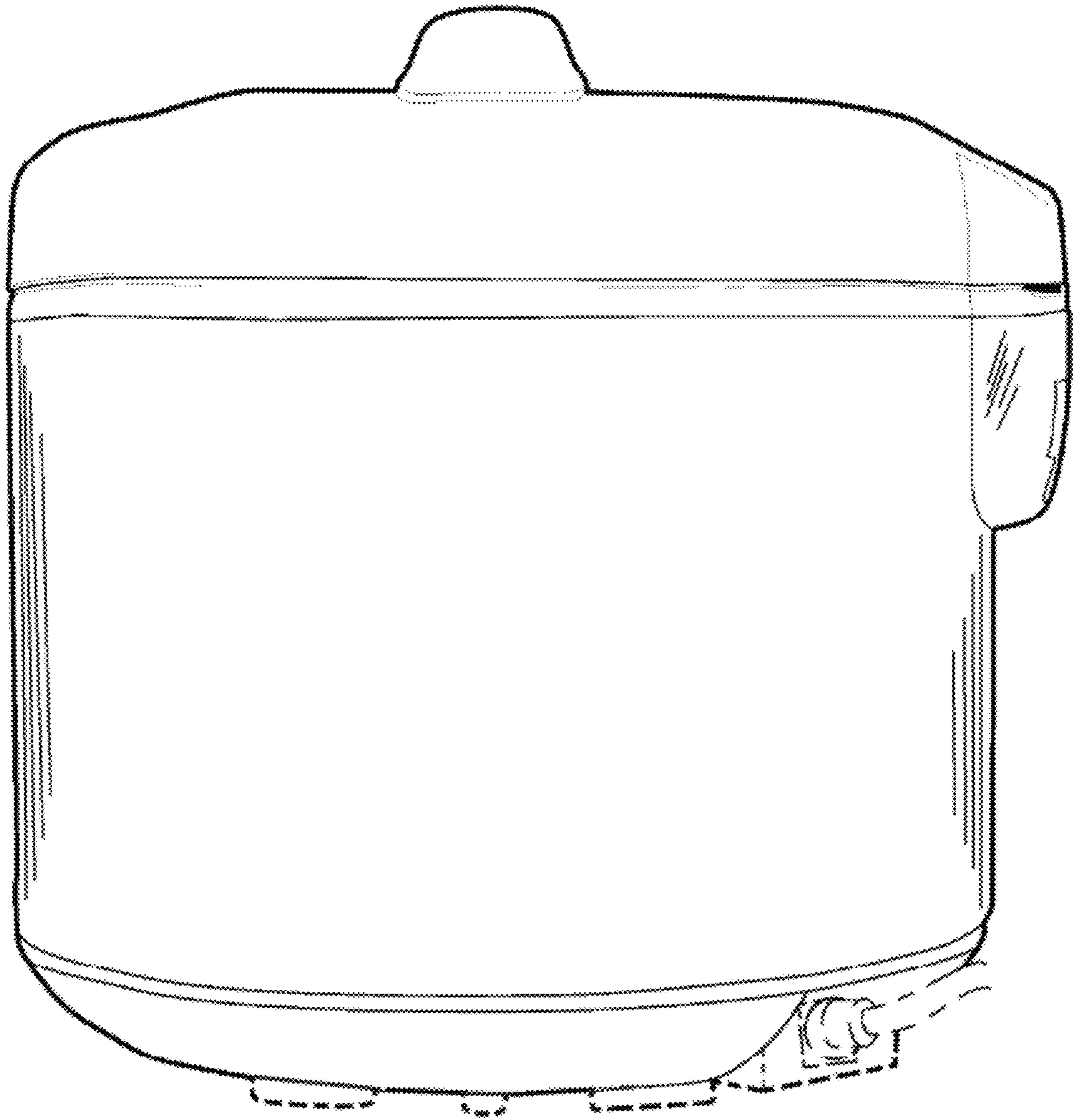

Fig. 5

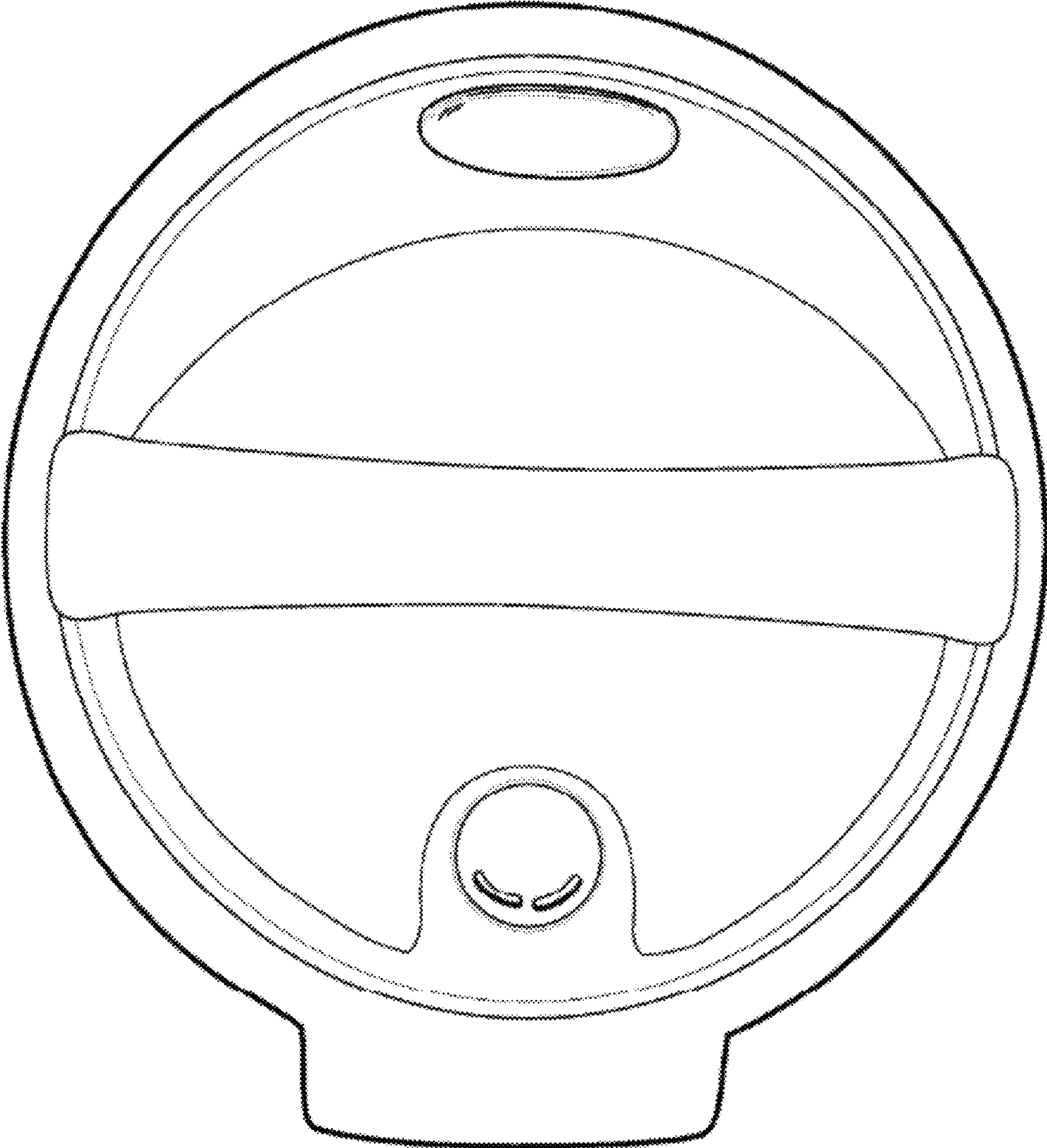

Fig. 6



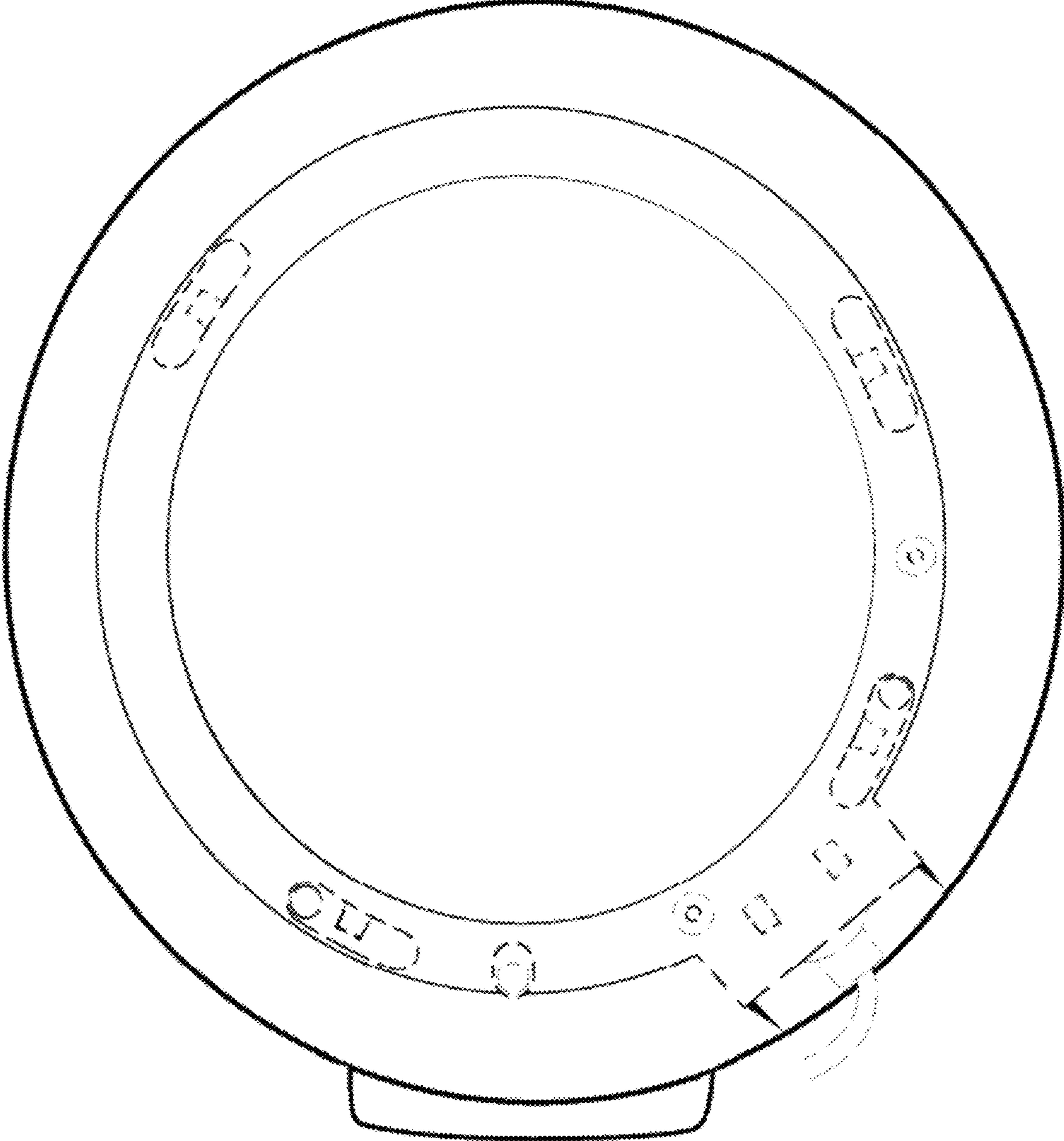

Fig. 7