

US00D756136S

(12) **United States Design Patent**
Santicchi

(10) **Patent No.:** **US D756,136 S**

(45) **Date of Patent:** **** May 17, 2016**

(54) **ROTATING COAT STAND**

(56) **References Cited**

(71) Applicant: **IMMOBILIARE METALPROGETTI SRL**, Perugia (IT)

U.S. PATENT DOCUMENTS

(72) Inventor: **Augusto Santicchi**, San Sisto (IT)

1,783,840	A	*	12/1930	Goeller	211/85.3
D145,822	S	*	10/1946	Rubin	D6/322
2,880,878	A	*	4/1959	Collette	211/1.56
3,019,911	A	*	2/1962	Collette	211/122
3,265,011	A	*	8/1966	Golden	104/93
4,192,563	A	*	3/1980	Levkovitch	312/134
5,474,187	A	*	12/1995	Taylor et al.	211/1.56
5,533,632	A	*	7/1996	Patterson et al.	211/122
D422,795	S	*	4/2000	Hollinger	D6/322
D711,153	S	*	8/2014	Bonham	D6/514

(73) Assignee: **Immobiliare Metalprogetti SRL**, Perugia (IT)

(**) Term: **14 Years**

* cited by examiner

(21) Appl. No.: **29/502,583**

(22) Filed: **Sep. 17, 2014**

Primary Examiner — Derrick Holland

Assistant Examiner — Lauren Calve

(30) **Foreign Application Priority Data**

Mar. 17, 2014 (EM) 2426429-0001 ✓

(74) *Attorney, Agent, or Firm* — Flaster/Greenberg, P.C.

(51) **LOC (10) Cl.** **06-08** ✓

(57) **CLAIM**

The ornamental design for a rotating coat stand, as shown and described.

(52) **U.S. Cl.**
USPC **D6/322** ✓

DESCRIPTION

(58) **Field of Classification Search**

USPC D6/315–328, 512, 513, 514, 553,
D6/569–572; 223/85–98; 211/1, 13.1,
211/85.3, 94.01, 94.02, 94.03, 95, 105.2,
211/106, 113, 119, 121, 122; 312/132, 134,
312/135
CPC ... A47G 25/746; A47G 25/743; A47G 25/74;
A47F 5/01; A47F 3/08; A47F 5/02; A47F
3/10; A47F 5/0892; A47F 5/08; A47F 7/24;
A47F 7/12; A47F 7/19; A47F 5/13; A47F
5/025; A47F 5/0037

FIG. 1 is a side perspective view of a rotating coat stand;
FIG. 2 is a second side perspective view of the rotating coat stand of FIG. 1;
FIG. 3 is a front perspective view from the front of the rotating coat stand of FIG. 1;
FIG. 4 is a back perspective view of the rotating coat stand of FIG. 1;
FIG. 5 bottom plan view of the rotating coat stand of FIG. 1;
FIG. 6 is a second back perspective view of the rotating coat stand of FIG. 1; and,
FIG. 7 is a top plan view of the rotating coat stand of FIG. 1.

See application file for complete search history.

1 Claim, 7 Drawing Sheets

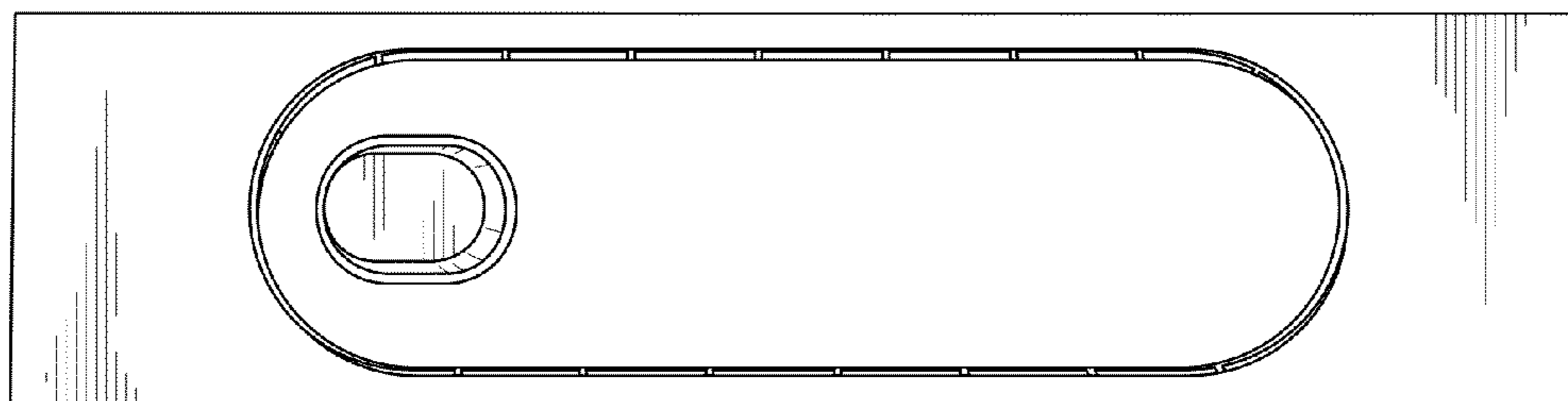
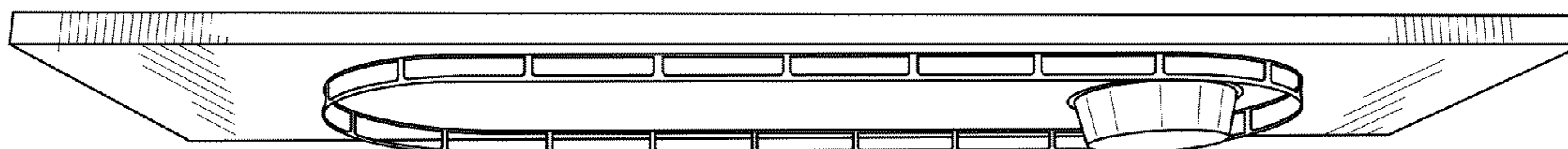

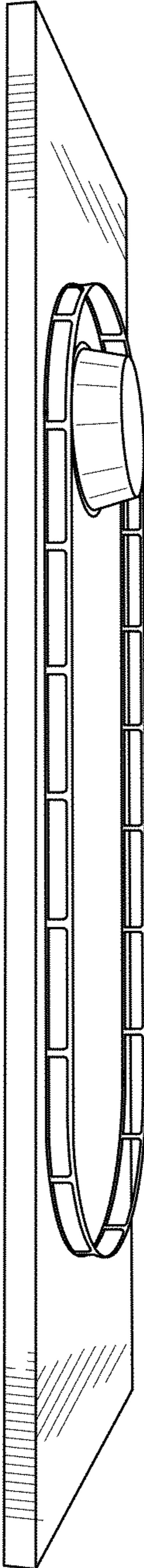

FIG. 1

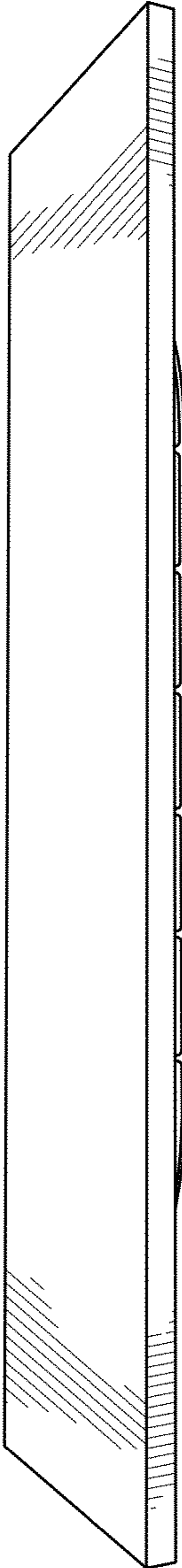

FIG. 2

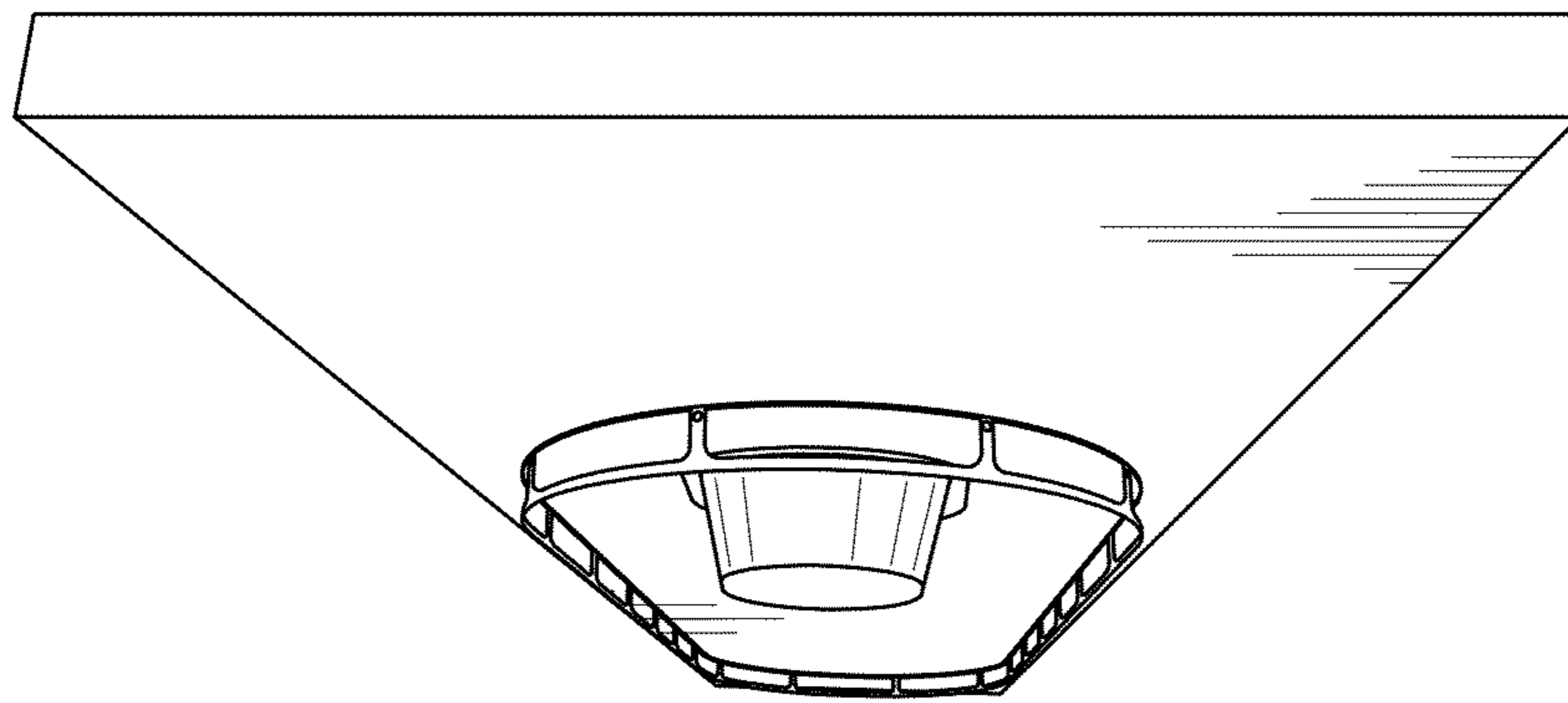

FIG. 3

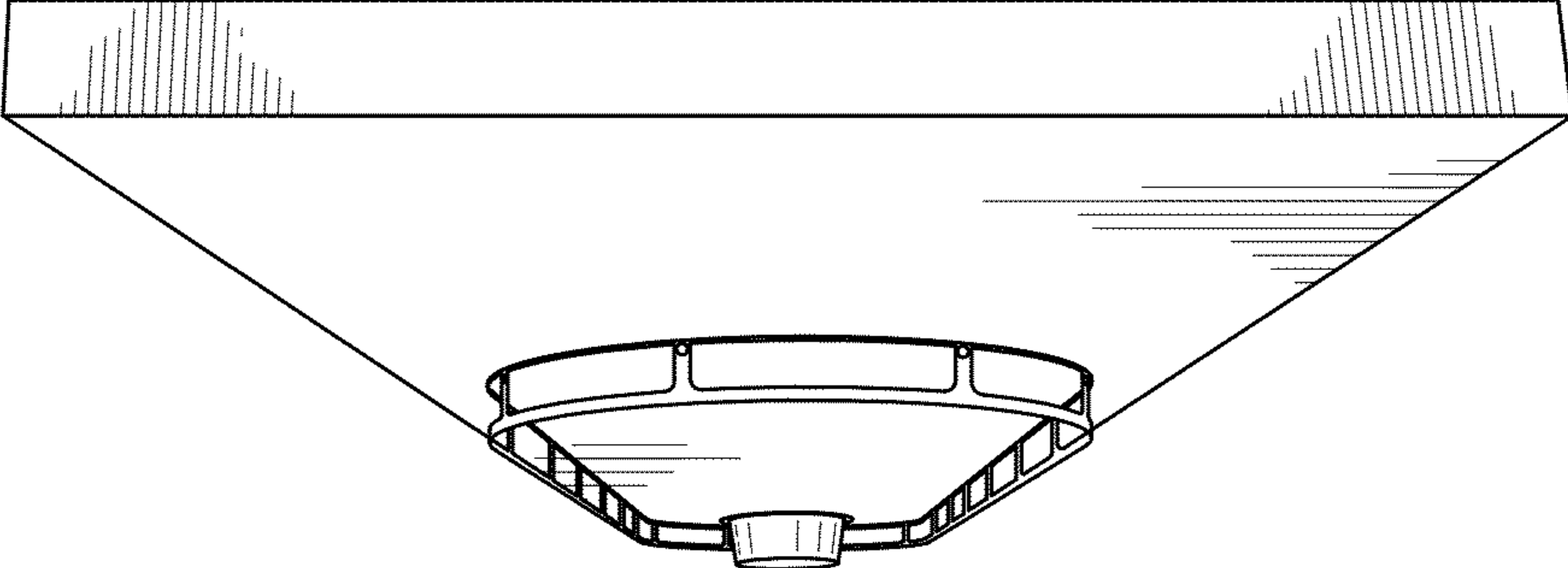

FIG.4

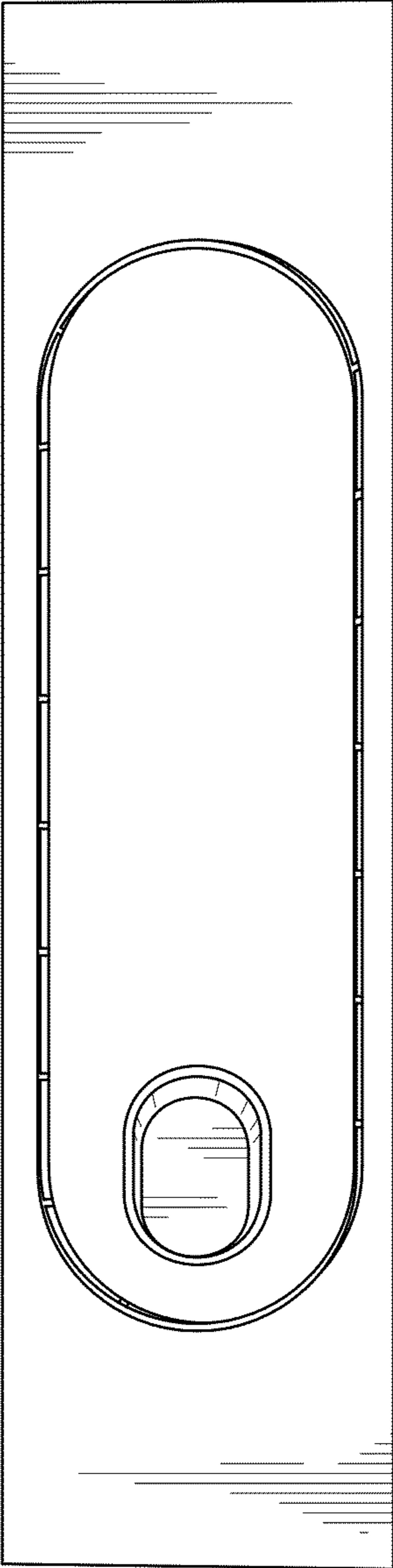

FIG. 5

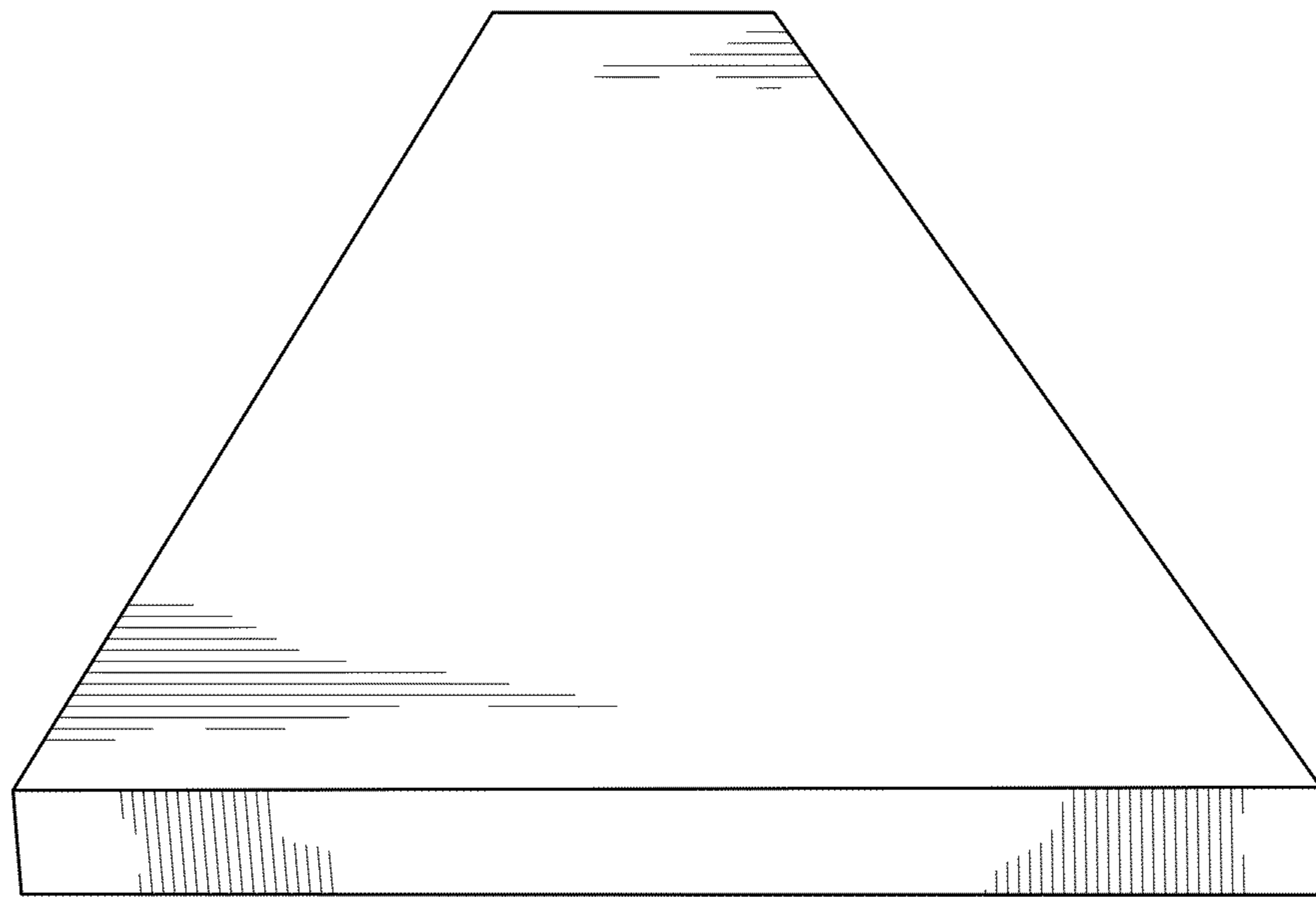

FIG. 6

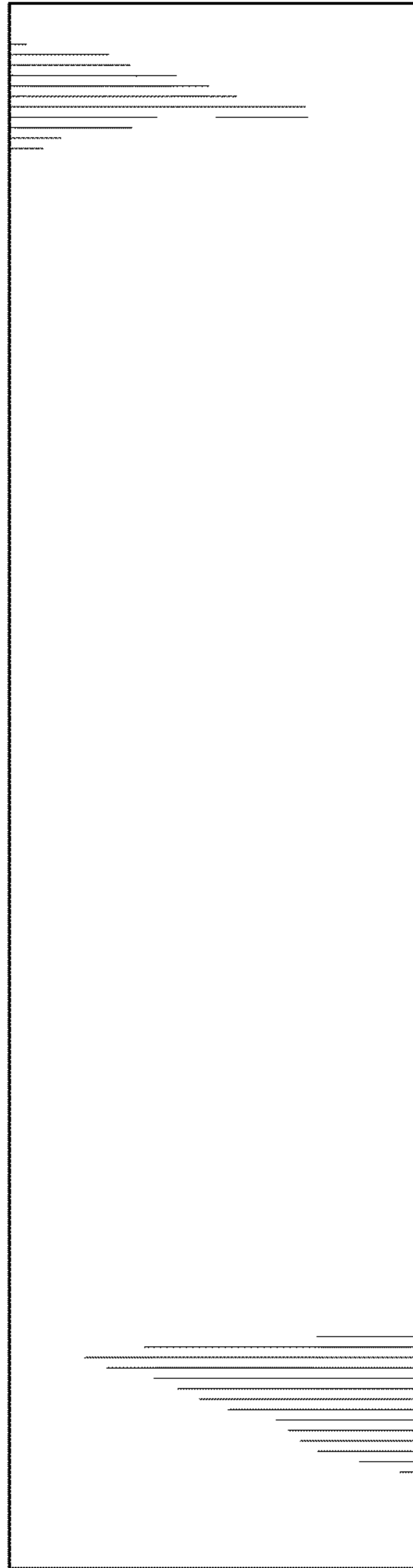

FIG. 7