



US00D756096S

(12) **United States Design Patent**  
**Bizzo**

(10) **Patent No.:** **US D756,096 S**

(45) **Date of Patent:** **\*\* May 17, 2016**

(54) **SHOE SOLE**

(71) Applicant: **Luca Bizzo**, Holmdel, NJ (US)

(72) Inventor: **Luca Bizzo**, Holmdel, NJ (US)

(73) Assignee: **AEROGROUP INTERNATIONAL HOLDINGS LLC**, Edison, NJ (US)

(\*\*) Term: **14 Years**

(21) Appl. No.: **29/498,441**

(22) Filed: **Aug. 4, 2014**

(51) **LOC (10) Cl.** ..... **02-04**

(52) **U.S. Cl.**  
USPC ..... **D2/960; D2/951**

(58) **Field of Classification Search**  
USPC ..... D2/902, 906, 908, 916, 918, 925,  
D2/946-962, 977; 36/3 B, 22 R, 24.5, 25 R,  
36/28, 32 R, 34 R, 59 C, 67 A, 103  
CPC ..... A43B 13/00; A43B 13/02; A43B 13/023;  
A43B 13/026; A43B 13/04; A43B 13/08;  
A43B 13/10; A43B 13/12; A43B 13/14;  
A43B 13/141; A43B 13/143; A43B 13/16;  
A43B 13/18; A43B 13/181; A43B 13/187;  
A43B 13/189; A43B 13/20; A43B 13/22;  
A43B 13/223; A43B 13/24; A43B 13/28;  
A43B 13/30; A43B 13/32; A43B 13/34;  
A43B 13/36

See application file for complete search history.

(56) **References Cited**

**U.S. PATENT DOCUMENTS**

- 2,307,032 A \* 1/1943 Fisch ..... A43B 13/14  
36/149
- 2,370,963 A \* 3/1945 Issaly ..... A43B 13/08  
12/146 R
- 2,981,011 A \* 4/1961 Lombardo ..... A43B 13/223  
36/28
- 3,290,803 A \* 12/1966 Spatola ..... A43B 13/12  
36/14
- D245,734 S \* 9/1977 Jacobs ..... D2/959

- D247,831 S \* 5/1978 Famolare, Jr. .... D2/955
- D250,617 S \* 12/1978 Noches ..... D2/908
- D269,139 S \* 5/1983 Stubblefield ..... D2/957
- D294,537 S \* 3/1988 Le ..... D2/960
- 4,766,681 A \* 8/1988 O'Rourke ..... A43B 7/20  
36/114
- D352,157 S \* 11/1994 Merceron ..... D2/957
- D378,318 S \* 3/1997 James ..... D2/951
- D390,346 S \* 2/1998 Loveder ..... D2/953
- 5,775,005 A \* 7/1998 McClelland ..... A43B 1/0072  
36/134
- D397,851 S \* 9/1998 Greenberg ..... D2/960

(Continued)

*Primary Examiner* — T. Chase Nelson

(74) *Attorney, Agent, or Firm* — Andrew F. Young, Esq.;  
Lackebach Siegel, LLP

(57) **CLAIM**

The ornamental design for a shoe sole, as shown and described.

**DESCRIPTION**

FIG. 1 is a front side perspective view of the embodiment of the present invention.

FIG. 2 is a front elevation view of the embodiment shown in FIG. 1.

FIG. 3 is a rear elevation view of the embodiment shown in FIG. 1.

FIG. 4 is a bottom plan view of the embodiment shown in FIG. 1.

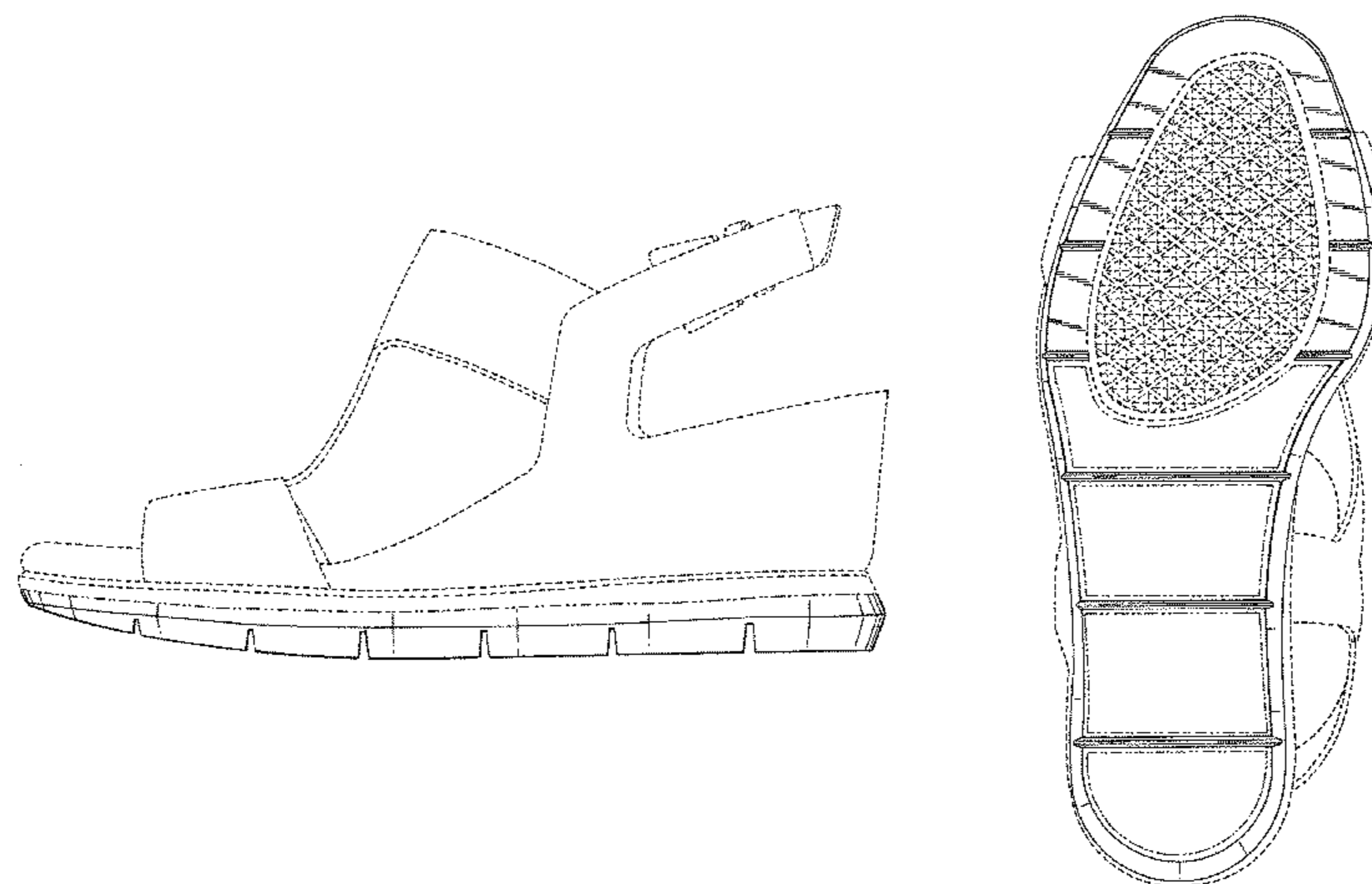
FIG. 5 is a top plan view of the embodiment shown in FIG. 1.

FIG. 6 is a right side elevation view of the embodiment shown in FIG. 1; and,

FIG. 7 is a left side elevation view of the embodiment shown in FIG. 1.

No claim is made to the dashed line regions on the shoe sole or the inner tread portions or diamond boundary outside the disclaimed break-lines as shown, nor is any claim made to the shoe upper as the dashed lines indicate disclaimed portions forming no part of the claimed design. No claimed portion is visible from the top, and FIG. 5 is provided to confirm.

**1 Claim, 7 Drawing Sheets**



(56)

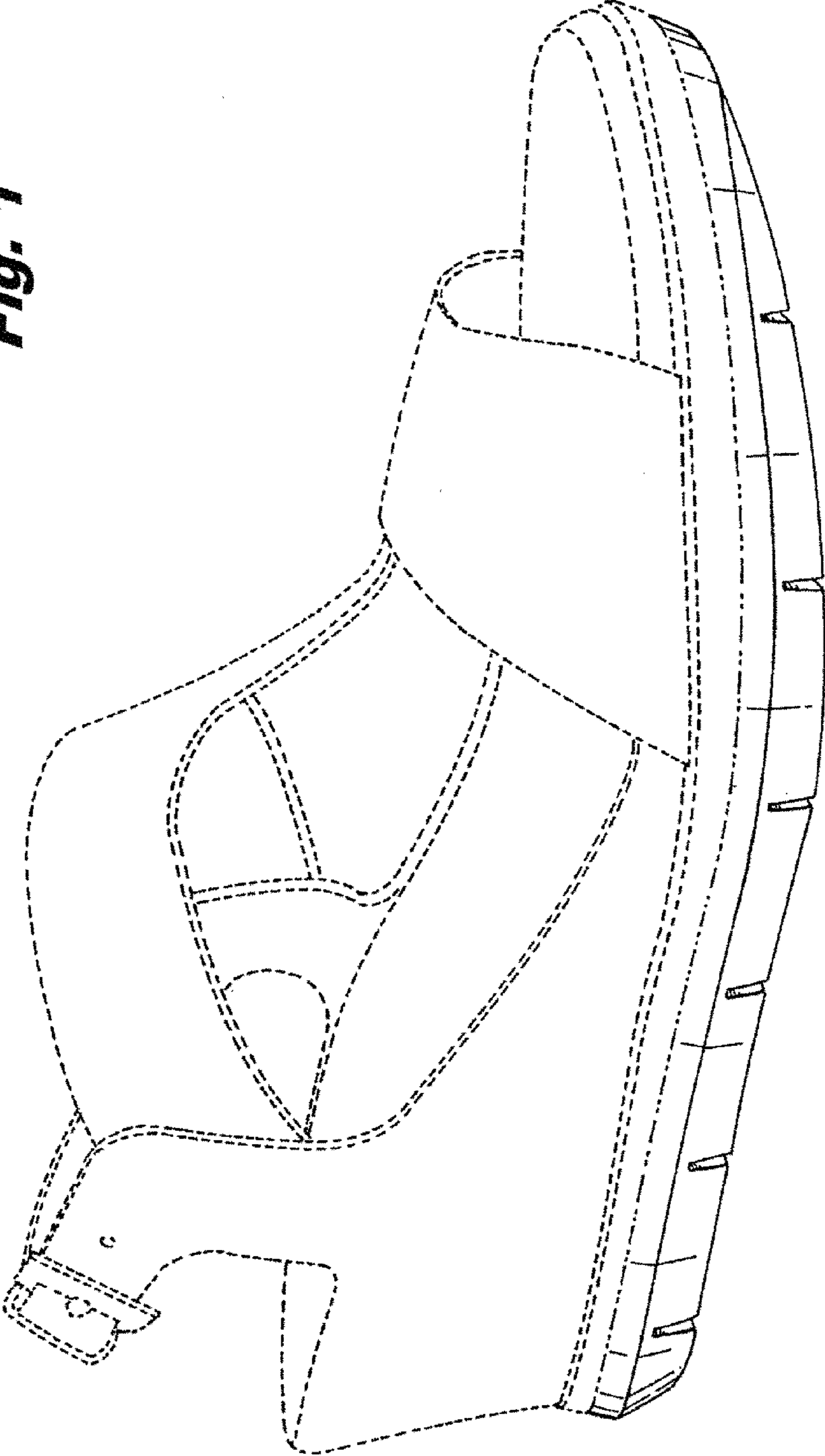
References Cited

U.S. PATENT DOCUMENTS

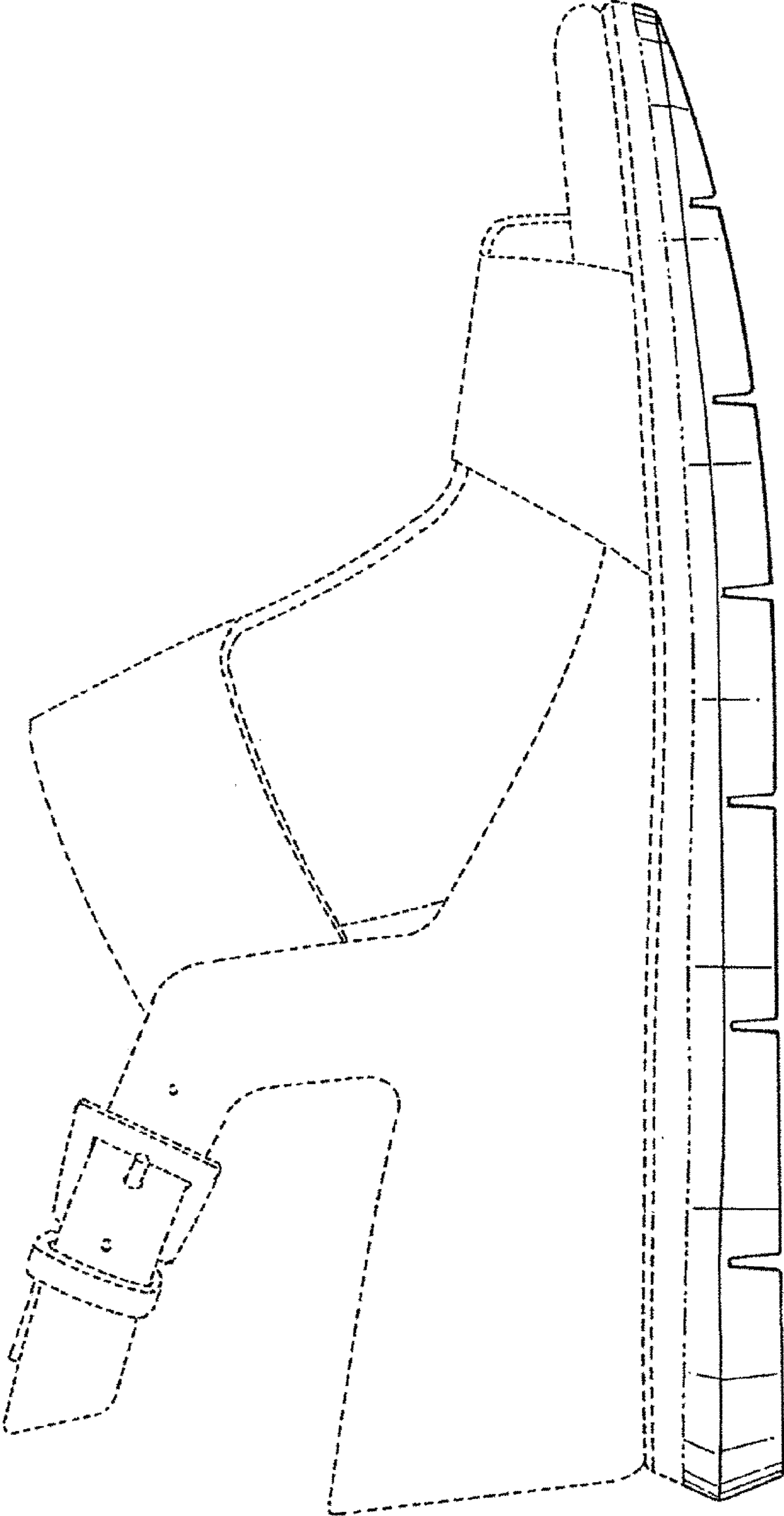
D399,345 S *	10/1998	Koh	D2/960	D693,553 S *	11/2013	McClaskie	D2/951
D401,041 S *	11/1998	Schneider	D2/951	D701,380 S *	3/2014	Reed	D2/951
D404,549 S *	1/1999	Greenberg	D2/954	D709,676 S *	7/2014	Iachini	D2/902
D405,943 S *	2/1999	Merceron	D2/957	D722,750 S *	2/2015	Vella	D2/951
D409,361 S *	5/1999	Greenberg	D2/957	D725,359 S *	3/2015	Miner	D2/947
D430,966 S *	9/2000	Brady	D2/902	D727,002 S *	4/2015	Sassi	D2/944
6,305,100 B1 *	10/2001	Komarnycky	A43B 7/08 36/27	D728,911 S *	5/2015	Spring	D2/951
D455,895 S *	4/2002	Yang	D2/951	D730,035 S *	5/2015	Henderson	D2/947
D458,011 S *	6/2002	Yang	D2/953	D730,640 S *	6/2015	Spring	D2/951
D470,303 S *	2/2003	Wu	D2/977	D734,005 S *	7/2015	Seo	D2/947
D503,028 S *	3/2005	Merceron	D2/947	D735,454 S *	8/2015	Yun	D2/951
D507,397 S *	7/2005	McClaskie	D2/957	D737,029 S *	8/2015	Bizzo	D2/947
D515,787 S *	2/2006	Woods	D2/902	D737,030 S *	8/2015	Bizzo	D2/951
D561,457 S *	2/2008	Andersen	D2/916	D737,031 S *	8/2015	Bizzo	D2/951
D561,988 S *	2/2008	Andersen	D2/916	D737,032 S *	8/2015	Bizzo	D2/951
D570,081 S *	6/2008	Longuet	D2/953	D737,558 S *	9/2015	Bizzo	D2/951
D593,742 S *	6/2009	Issler	D2/951	D740,007 S *	10/2015	Lan	D2/951
D595,487 S *	7/2009	Issler	D2/951	D746,562 S *	1/2016	Babcock	D2/951
D596,385 S *	7/2009	McDade	D2/953	D747,859 S *	1/2016	Henderson	D2/947
D596,386 S *	7/2009	Brambilla	D2/951	D748,386 S *	2/2016	Henderson	D2/947
D611,692 S *	3/2010	Bizzo	D2/951	2011/0289799 A1 *	12/2011	Keating	A43B 7/144 36/103
D643,197 S *	8/2011	Teteriatnikov	D2/951	2012/0079747 A1 *	4/2012	Seo	A43B 13/183 36/25 R
D643,602 S *	8/2011	Teteriatnikov	D2/946	2012/0167416 A1 *	7/2012	Christensen	A43B 3/0057 36/103
D649,754 S *	12/2011	Callahan	D2/951	2013/0185956 A1 *	7/2013	Biancucci	A43B 3/26 36/28
D660,568 S *	5/2012	Blakeslee	D2/951	2015/0101215 A1 *	4/2015	Henderson	A43B 3/0057 36/103
D667,619 S *	9/2012	Blakeslee	D2/951	2015/0143722 A1 *	5/2015	Faggin	A43B 3/108 36/25 R
D671,723 S *	12/2012	Teteriatnikov	D2/947				
D675,003 S *	1/2013	Leon	D2/950				
D684,348 S *	6/2013	Castellon	D2/951				

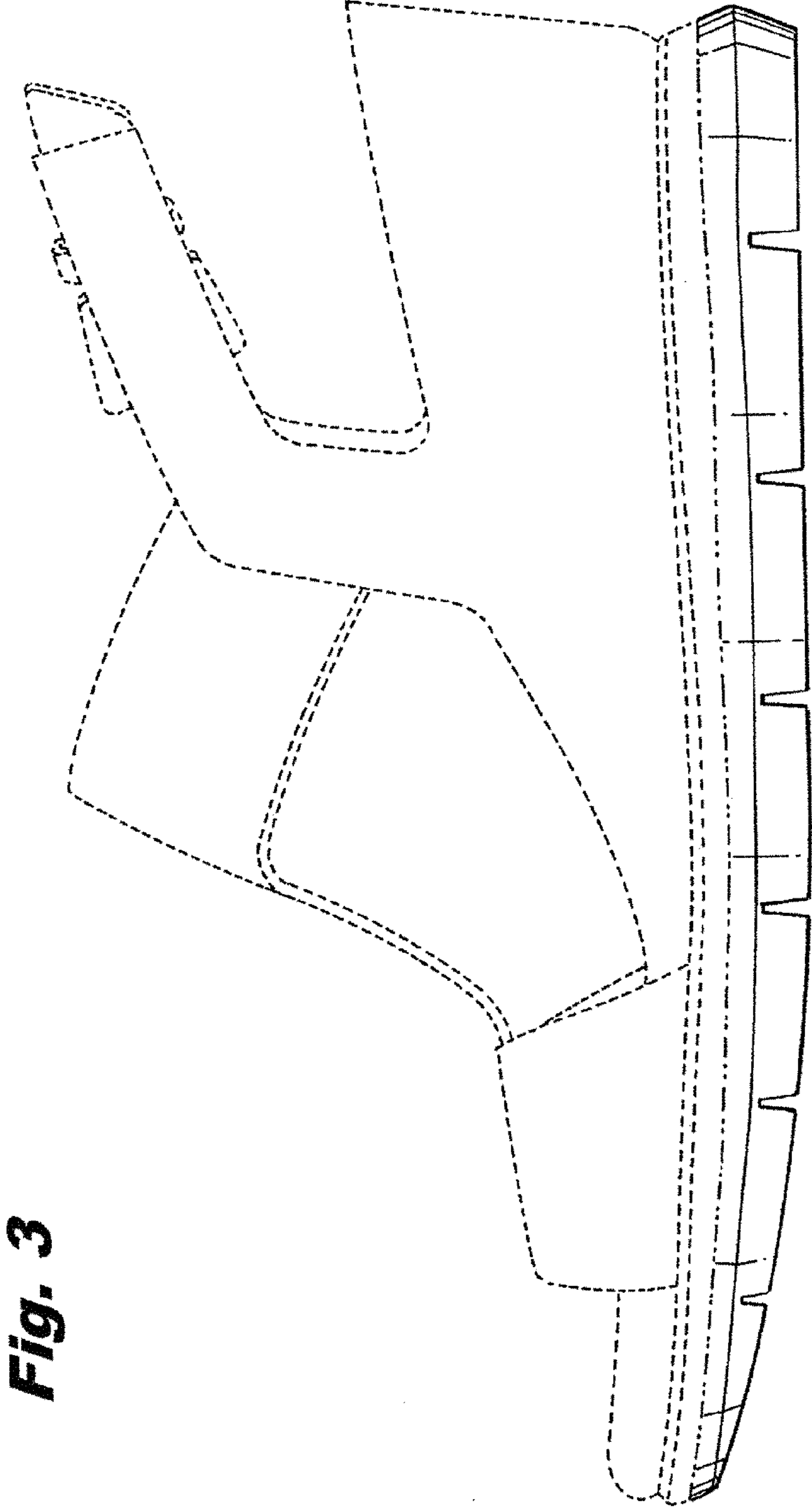
\* cited by examiner

**Fig. 1**



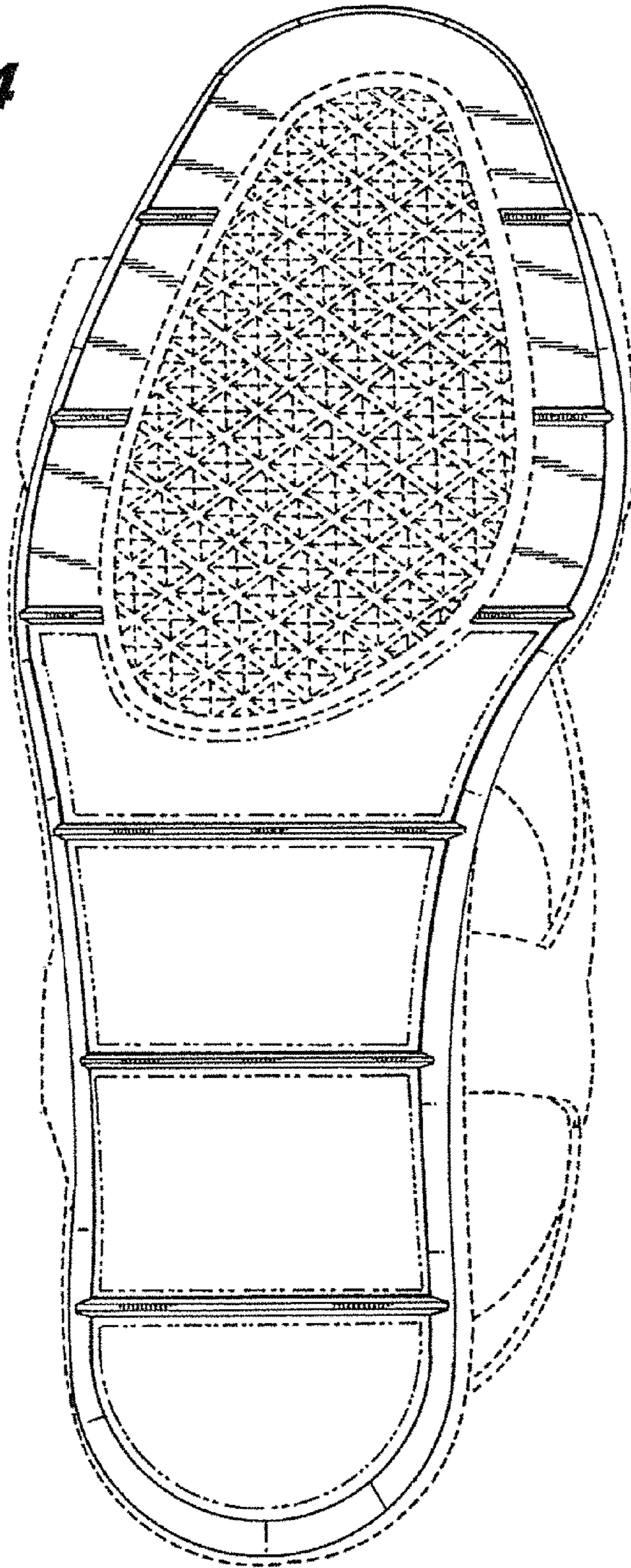
**Fig. 2**

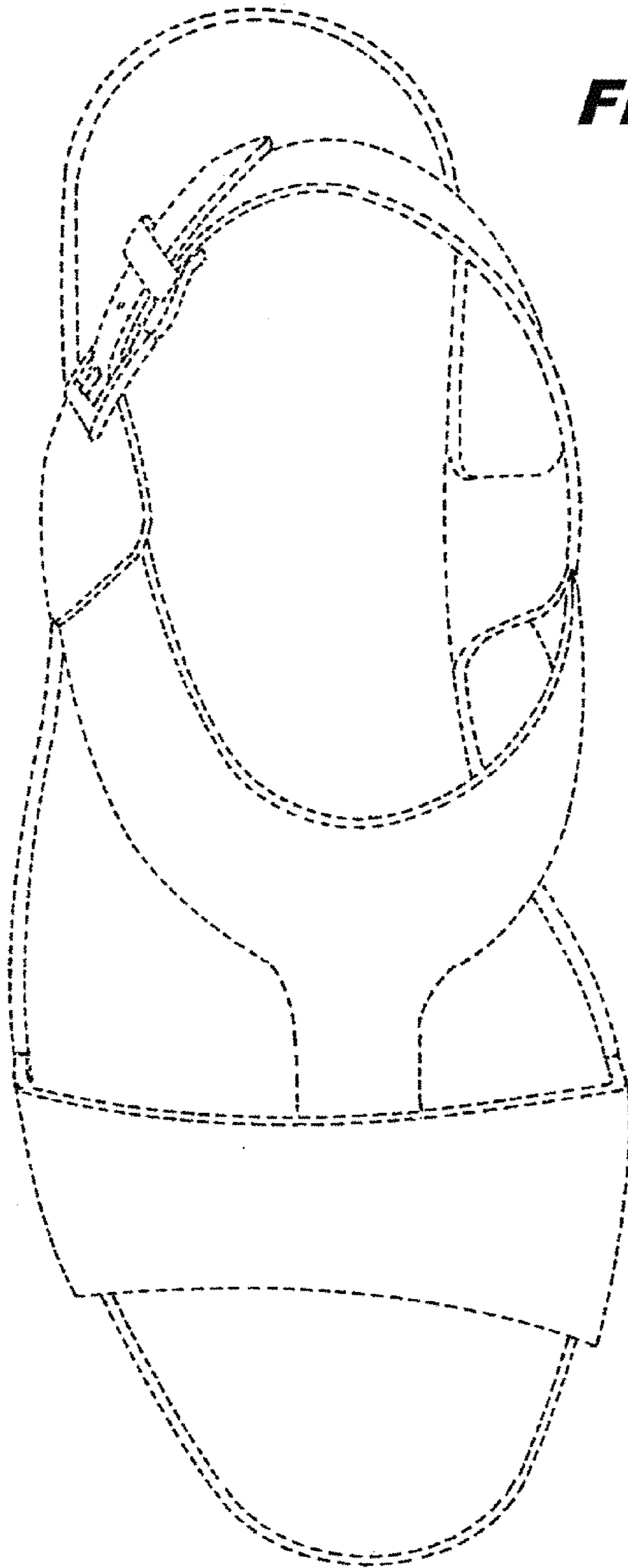




**Fig. 3**

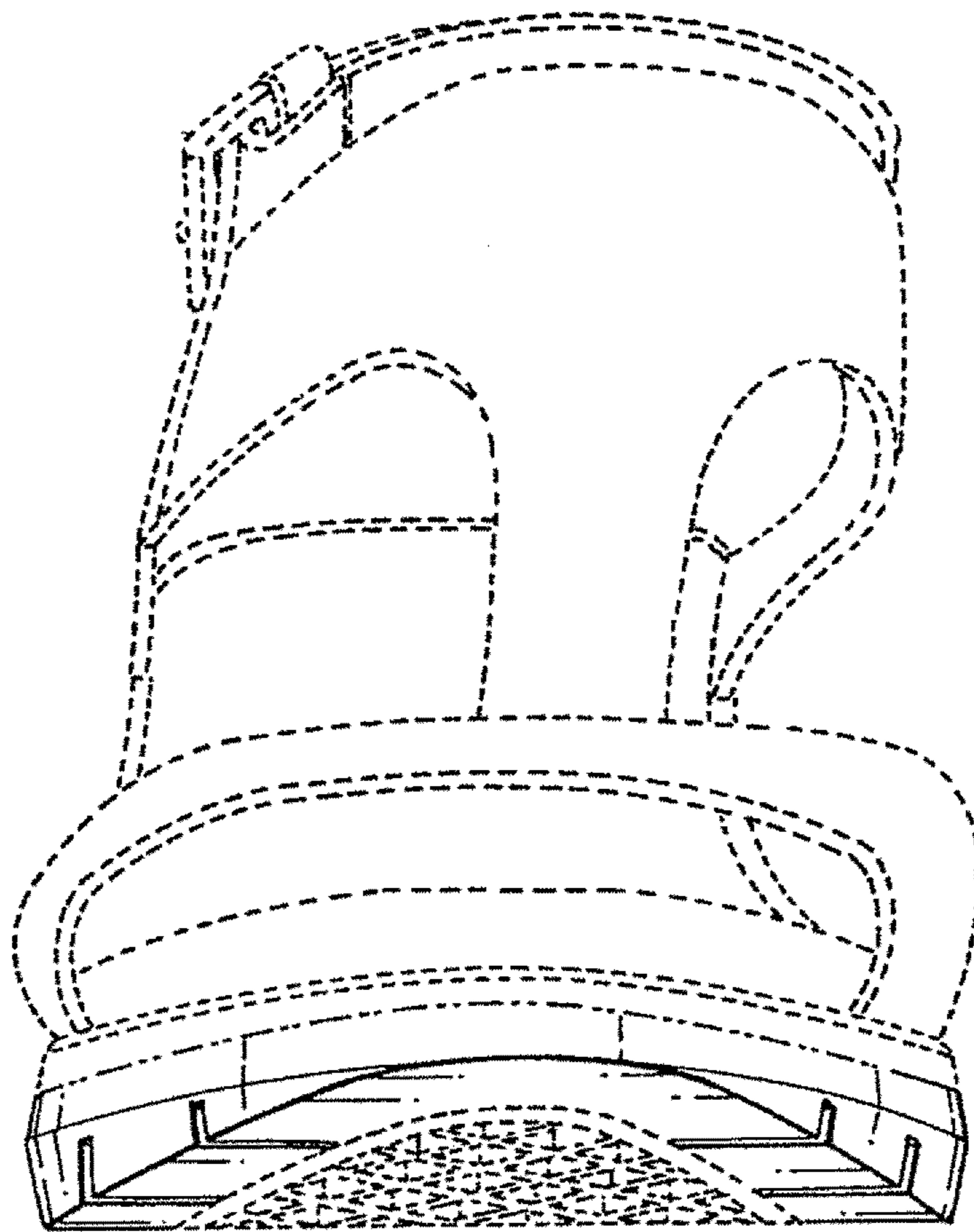
**Fig. 4**





**Fig. 5**

***Fig. 6***





***Fig. 7***

