



US00D756062S

(12) **United States Design Patent**  
**Fernandez et al.**

(10) **Patent No.:** **US D756,062 S**  
(45) **Date of Patent:** **\*\* May 10, 2016**

- (54) **TRANSPARENT CASKET**
- (71) Applicants: **Rangel Fernandez**, Doral, FL (US);  
**Andrea Rojas**, Doral, FL (US)
- (72) Inventors: **Rangel Fernandez**, Doral, FL (US);  
**Andrea Rojas**, Doral, FL (US)
- (\*\*) Term: **14 Years**
- (21) Appl. No.: **29/523,914**
- (22) Filed: **Apr. 15, 2015**
- (51) **LOC (10) Cl.** ..... **99-00**
- (52) **U.S. Cl.**  
USPC ..... **D99/4; D99/1**
- (58) **Field of Classification Search**  
USPC ..... D99/1, 4, 7, 11, 17, 19; 27/1-8, 19, 25;  
40/124.5; D20/41, 17; D6/300;  
D11/122, 131; 312/111, 107, 114;  
52/103  
CPC ..... A61G 17/00  
See application file for complete search history.

(56) **References Cited**

**U.S. PATENT DOCUMENTS**

D50,880 S \* 6/1917 Smith ..... D99/1  
1,454,427 A 5/1923 Cunning  
1,622,777 A \* 3/1927 Fleeman ..... A61G 17/02  
27/3  
D86,095 S \* 1/1932 Seely ..... D99/7  
D93,603 S \* 10/1934 Blackford ..... D99/1  
D93,911 S \* 11/1934 Cohen ..... D99/1  
2,159,144 A 5/1939 Fletcher  
D133,331 S \* 8/1942 Zaiser ..... D99/7  
D138,492 S \* 8/1944 Ayuso ..... D99/1  
D138,497 S 8/1944 Schmidt  
2,533,827 A \* 12/1950 McEwan ..... A61G 17/02  
27/17  
2,533,828 A \* 12/1950 McEwan ..... A61G 17/02  
27/17  
2,548,706 A \* 4/1951 Corning ..... G09F 23/08  
220/377  
2,579,756 A 12/1951 Reed  
2,587,355 A \* 2/1952 McEwan ..... A61G 17/02  
16/324  
2,661,229 A \* 12/1953 Slaughter, Jr. .... A61G 17/02  
27/17  
2,907,090 A \* 10/1959 Gaspardo ..... A61G 17/00  
220/315

3,066,374 A \* 12/1962 Garson ..... A41F 15/002  
24/198  
3,344,494 A \* 10/1967 McClive ..... A61G 17/00  
27/19  
3,353,238 A \* 11/1967 Sieloff ..... A61G 17/00  
16/436  
3,411,191 A \* 11/1968 Ikert ..... A61G 17/00  
220/62.22  
3,521,920 A \* 7/1970 Morand ..... E04H 13/00  
27/17  
3,570,082 A \* 3/1971 Gruber ..... A61G 17/00  
16/268  
3,613,189 A \* 10/1971 Kirby ..... A61G 17/04  
27/35  
D227,562 S \* 7/1973 Pitt ..... D99/1  
3,781,948 A \* 1/1974 Pitt ..... A61G 17/02  
27/17  
3,810,282 A \* 5/1974 Doggett ..... A61G 17/00  
27/19  
3,879,818 A \* 4/1975 Rowland ..... A61G 17/007  
27/10  
3,944,267 A \* 3/1976 Sundquist ..... A61G 17/00  
292/139  
D294,763 S \* 3/1988 Beardsley ..... D99/7  
4,788,757 A \* 12/1988 Bethune ..... A61G 17/00  
27/12  
4,949,439 A \* 8/1990 Semon ..... A61G 17/04  
27/11  
5,007,148 A \* 4/1991 Bida ..... A61G 17/04  
101/32  
5,301,398 A 4/1994 Bursey, Jr.  
H1348 H \* 9/1994 Linville ..... A61G 17/04  
27/19  
5,611,124 A \* 3/1997 Biondo ..... A61G 17/04  
27/14  
5,727,291 A \* 3/1998 Biondo ..... A61G 17/04  
27/1  
D408,114 S 4/1999 Poitier et al.  
5,926,929 A \* 7/1999 MacKirby ..... A61G 17/04  
27/11  
5,966,786 A \* 10/1999 Bowling ..... A61G 17/02  
27/17  
6,324,736 B1 \* 12/2001 Atrio ..... A61G 17/04  
27/14  
6,434,804 B1 \* 8/2002 Cornet ..... A47C 19/025  
27/2  
6,898,830 B1 \* 5/2005 Acton ..... A61G 17/00  
27/1  
7,908,720 B2 \* 3/2011 Rojdev ..... A61G 17/04  
27/10  
2007/0050959 A1 \* 3/2007 Biterman ..... A61G 17/04  
27/28

\* cited by examiner

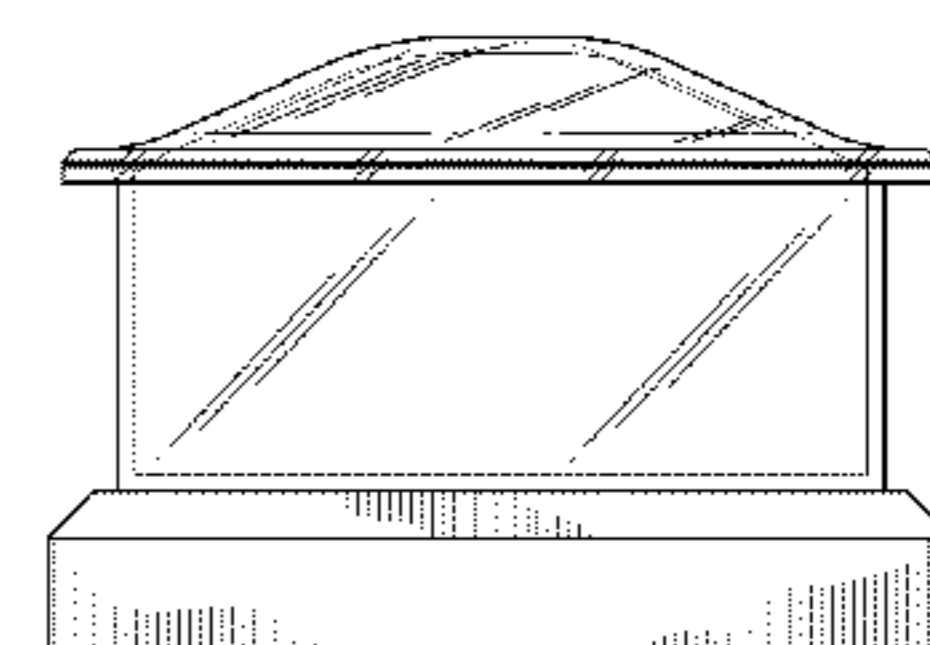
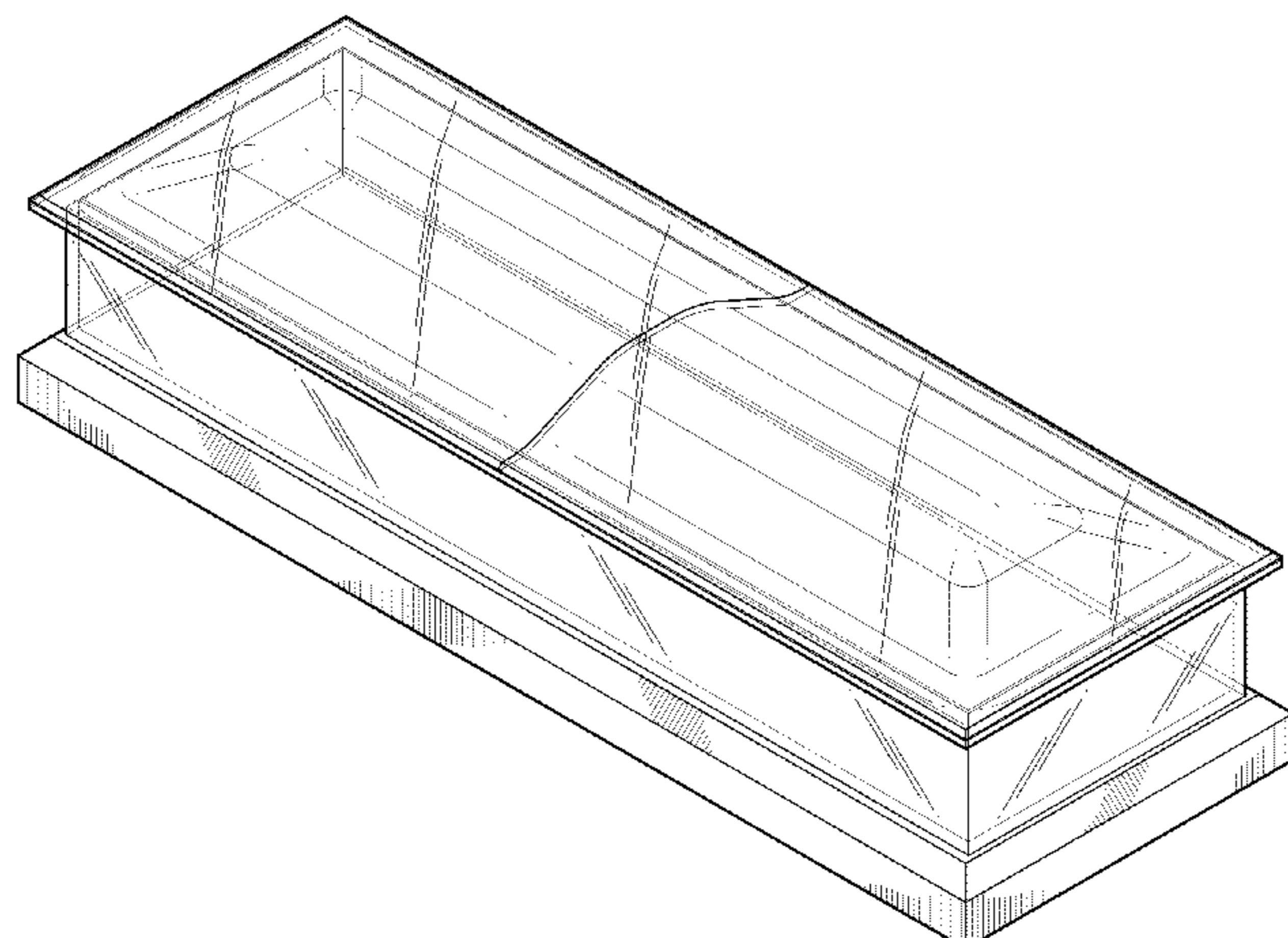

*Primary Examiner* — Paula Greene

(74) *Attorney, Agent, or Firm* — Robert M. Downey, P.A.

(57)

**CLAIM**

The ornamental design for a transparent casket, as shown and described.

**DESCRIPTION**

FIG. 1 is a front, top perspective view of a transparent casket showing our new design;

FIG. 2 is a front elevational view thereof, the rear elevational view being identical thereto;

FIG. 3 is a right end elevational view thereof, the left end elevational view being identical thereto;

FIG. 4 is a top plan view thereof; and,

FIG. 5 is a bottom plan view thereof.

**1 Claim, 3 Drawing Sheets**

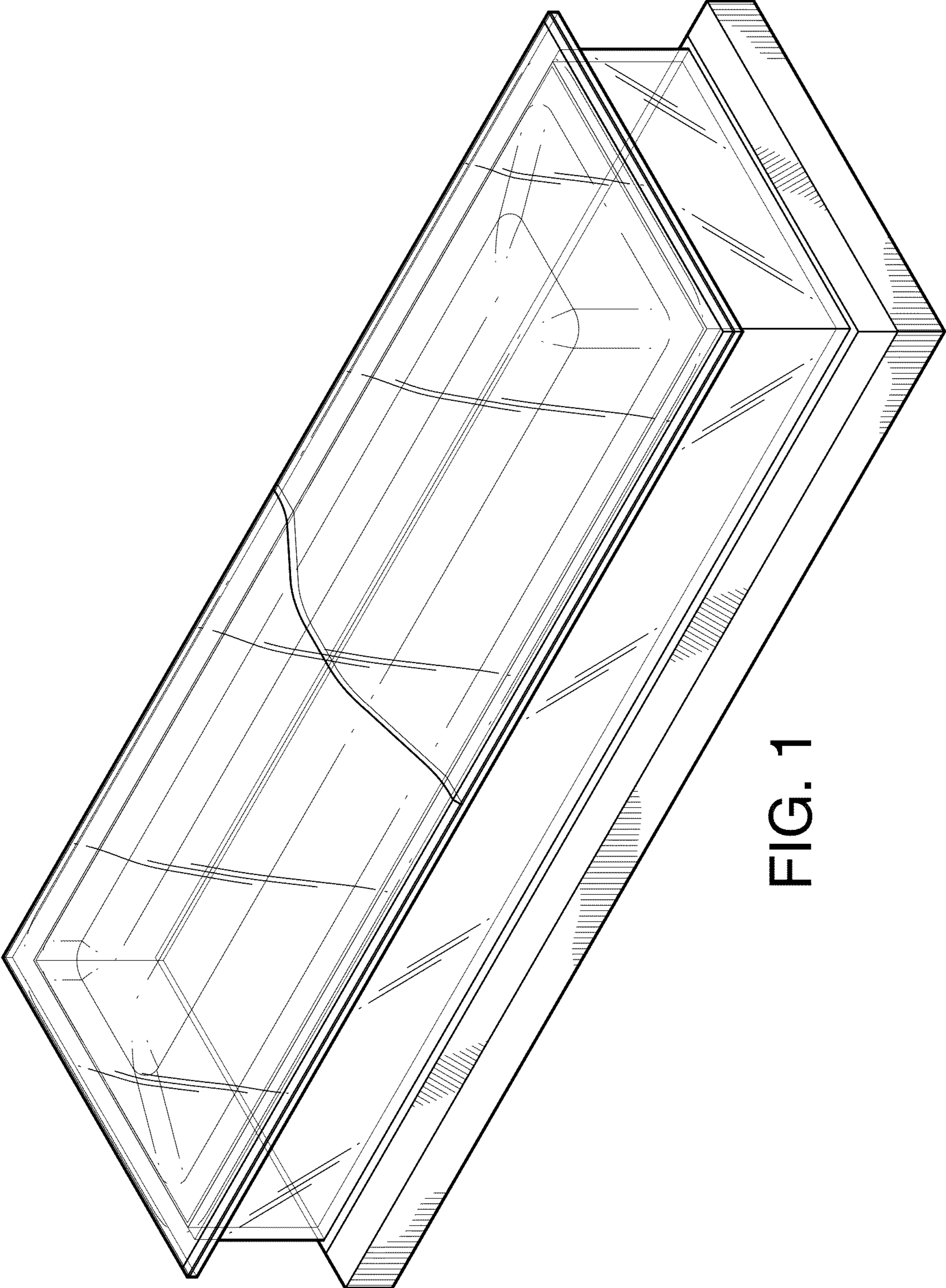

FIG. 1

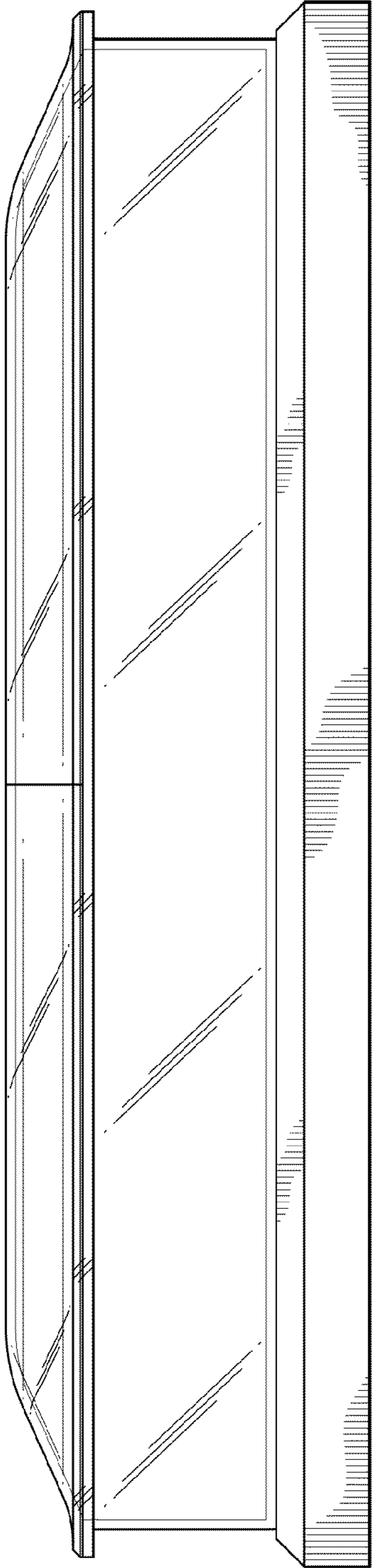

FIG. 2

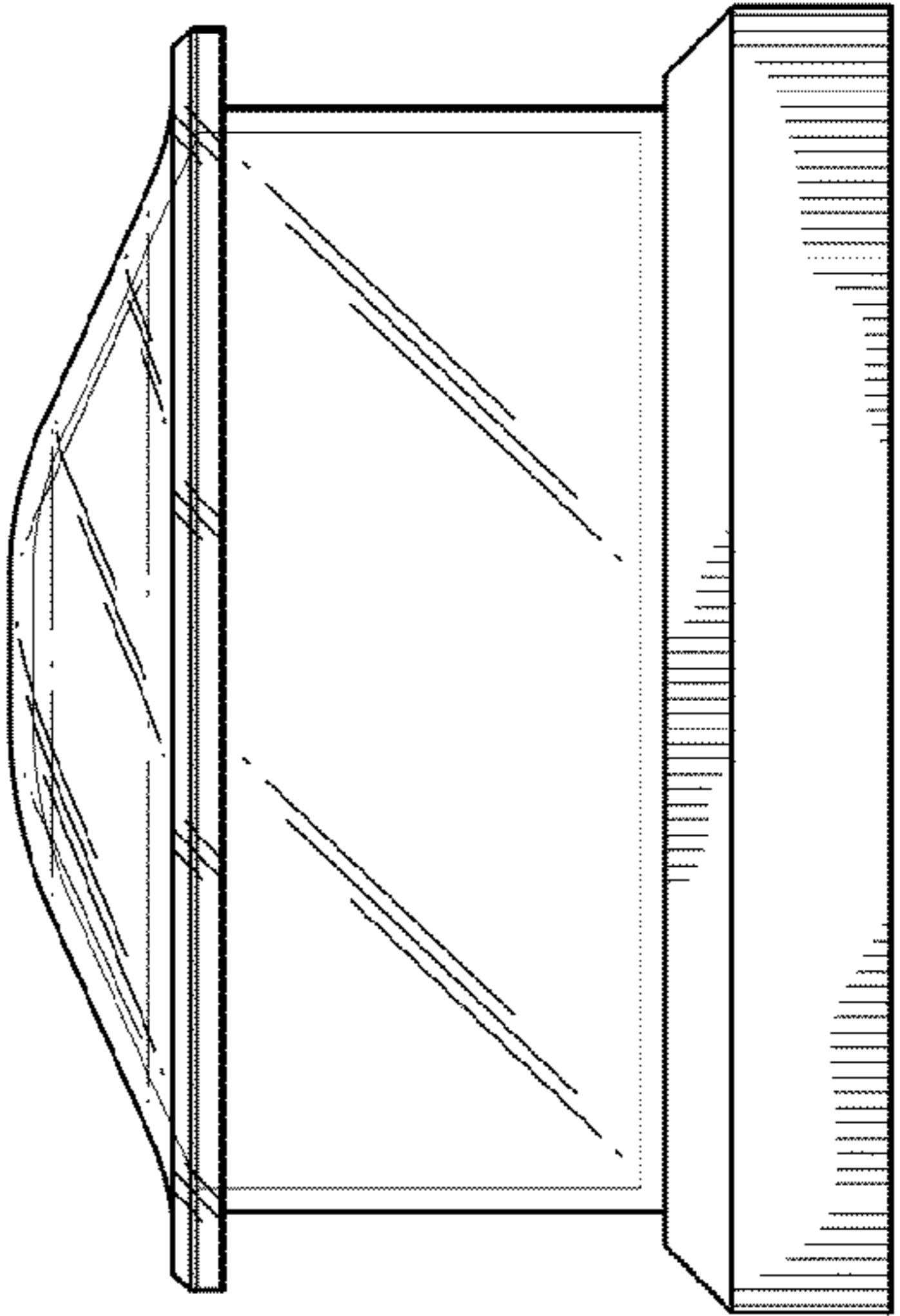

FIG. 3

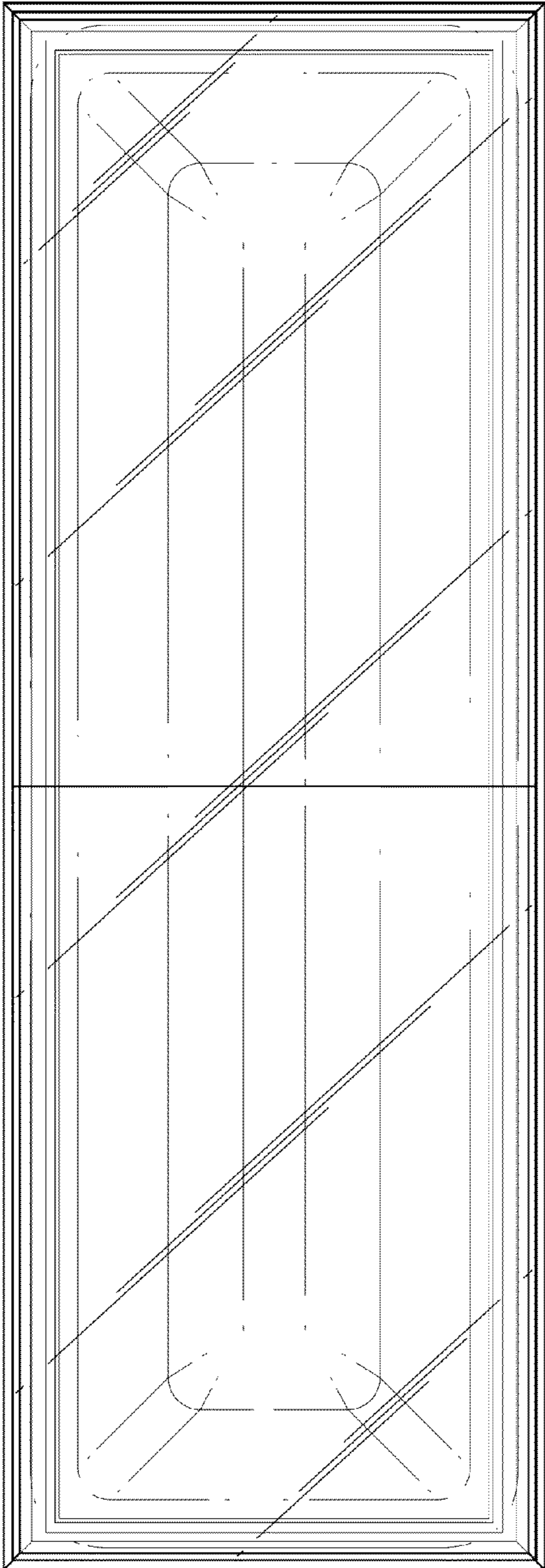

FIG. 4

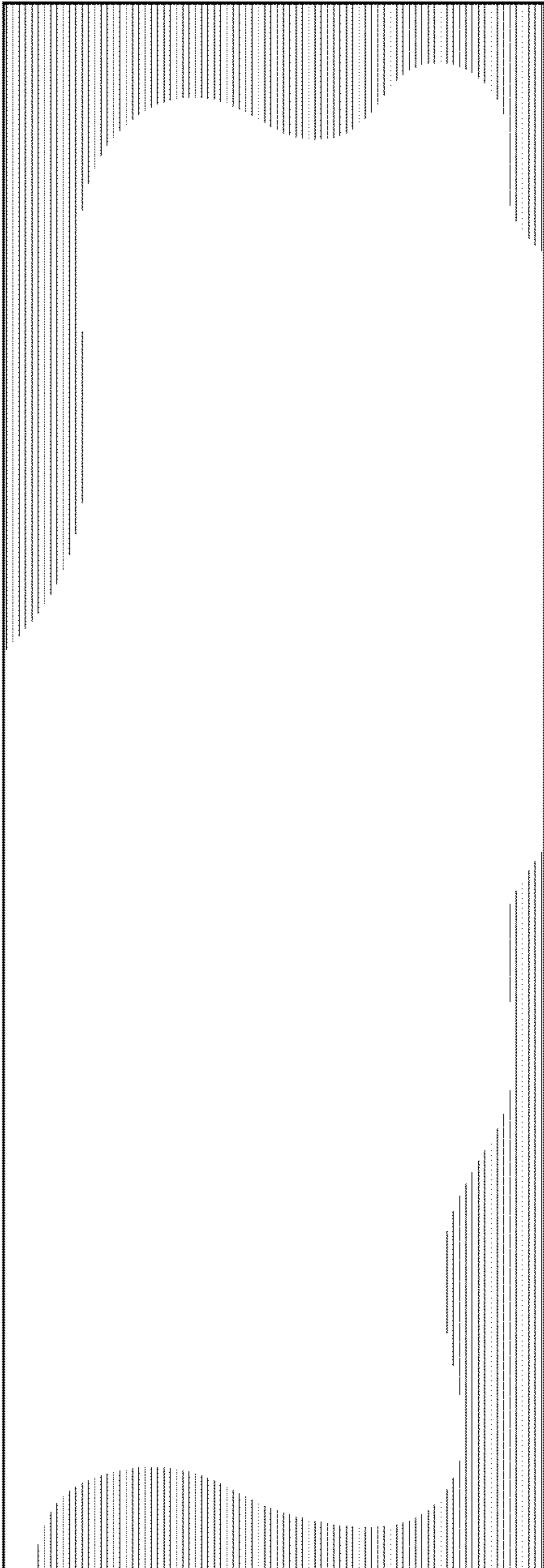

FIG. 5