



US00D756008S

(12) **United States Design Patent**  
**Wilson**

(10) **Patent No.:** **US D756,008 S**

(45) **Date of Patent:** **\*\* May 10, 2016**

(54) **RECTANGULAR LIGHT WITH SWITCH ASSEMBLY FOR A RECREATIONAL VEHICLE**

(71) Applicant: **Gregg Wilson**, Avondale, AZ (US)

(72) Inventor: **Gregg Wilson**, Avondale, AZ (US)

(\*\*) Term: **14 Years**

(21) Appl. No.: **29/513,267**

(22) Filed: **Dec. 29, 2014**

(51) **LOC (10) Cl.** ..... **26-06**

(52) **U.S. Cl.**  
USPC ..... **D26/31**

(58) **Field of Classification Search**

USPC ..... D26/28-36; 362/61, 80-83, 267-269,  
362/459-468, 475-478, 485-487

CPC ..... F21S 48/00; F21S 48/10; F21S 48/115;  
F21S 48/225; F21S 48/1233; F21S 48/1266;  
F21S 48/1388; F21S 48/2268; F21V 21/04

See application file for complete search history.

(56) **References Cited**

**U.S. PATENT DOCUMENTS**

D526,430 S *	8/2006	Hernandez	.....	D26/31
D576,754 S *	9/2008	Wang	.....	D26/31
D653,783 S *	2/2012	Biro	.....	D26/31
D662,632 S	6/2012	Wilson		

\* cited by examiner

*Primary Examiner* — Marcus Jackson

(57) **CLAIM**

The novel ornamental design for a rectangular light with switch assembly for a recreational vehicle, as shown and described.

**DESCRIPTION**

FIG. 1 is a perspective view of the rectangular light with switch assembly for a recreational vehicle;

FIG. 2 is a front elevational view of the rectangular light with switch assembly for a recreational vehicle in accordance with the present invention;

FIG. 3 is a top plan view of the rectangular light with switch assembly for a recreational vehicle;

FIG. 4 is a bottom plan view of the rectangular light with switch assembly for a recreational vehicle;

FIG. 5 is a right side elevational view of the rectangular light with switch assembly for a recreational vehicle;

FIG. 6 is a left side elevational view of the rectangular light with switch assembly for a recreational vehicle;

FIG. 7 is a back view of the rectangular light with switch assembly for a recreational vehicle;

FIG. 8 is a perspective-exploded view of the rectangular light with switch assembly for a recreational vehicle; and,

FIG. 9 is a back elevational view of a recreational vehicle in dotted lines showing the rectangular light with switch assembly for a recreational vehicle thereon.

The broken lines in the drawings represent unclaimed environmental subject matter.

**1 Claim, 8 Drawing Sheets**

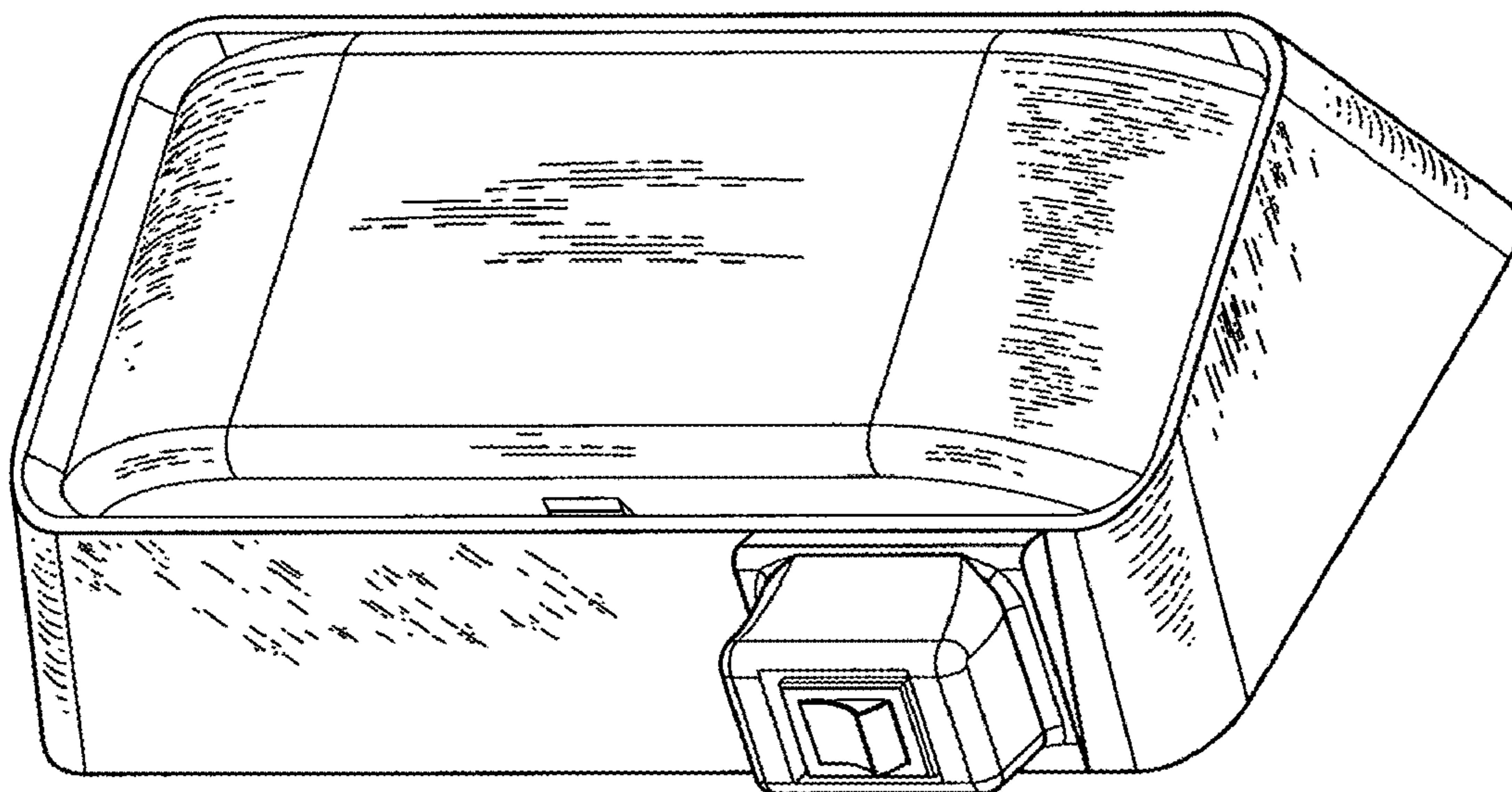

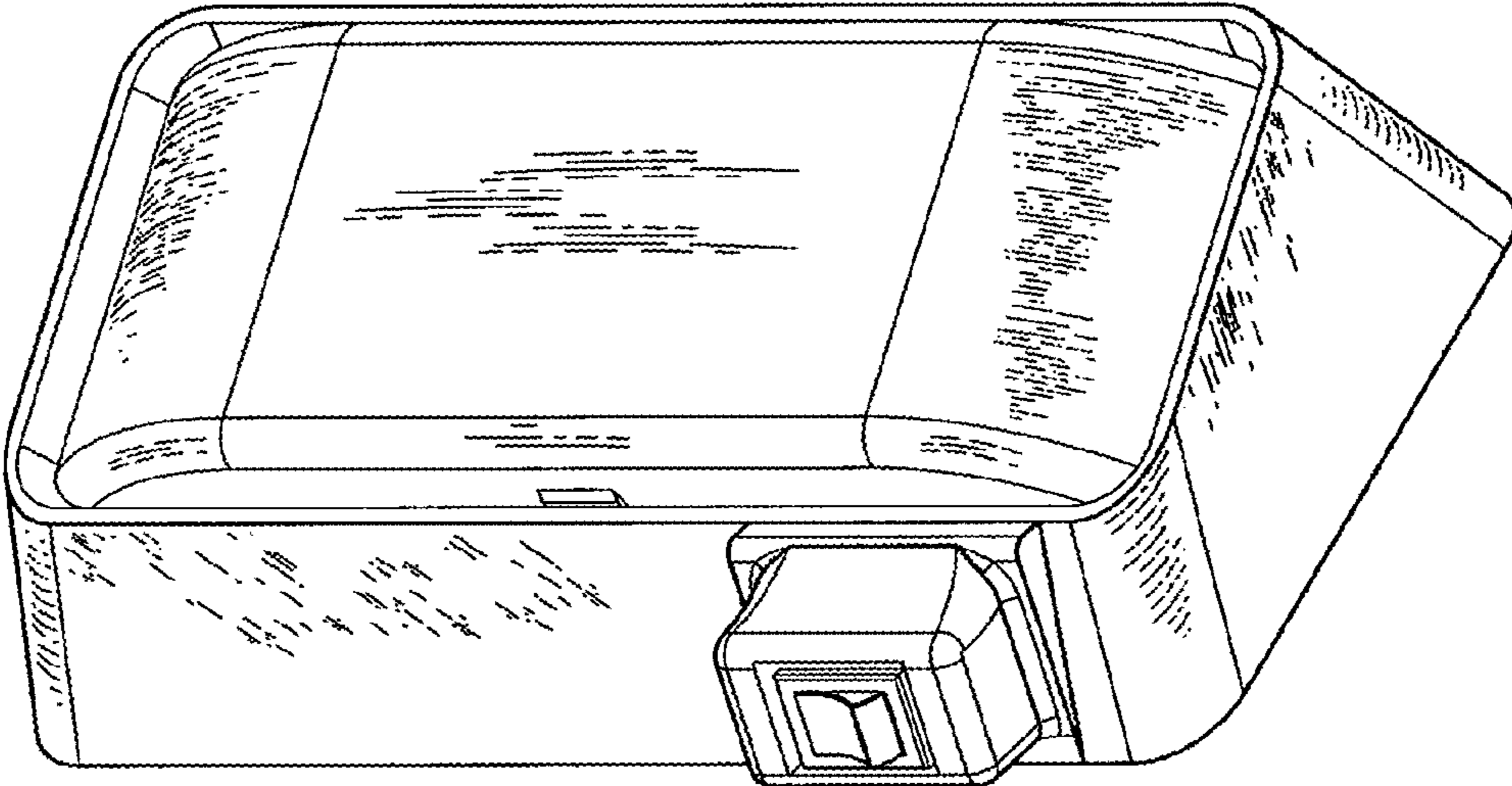

FIG. 1

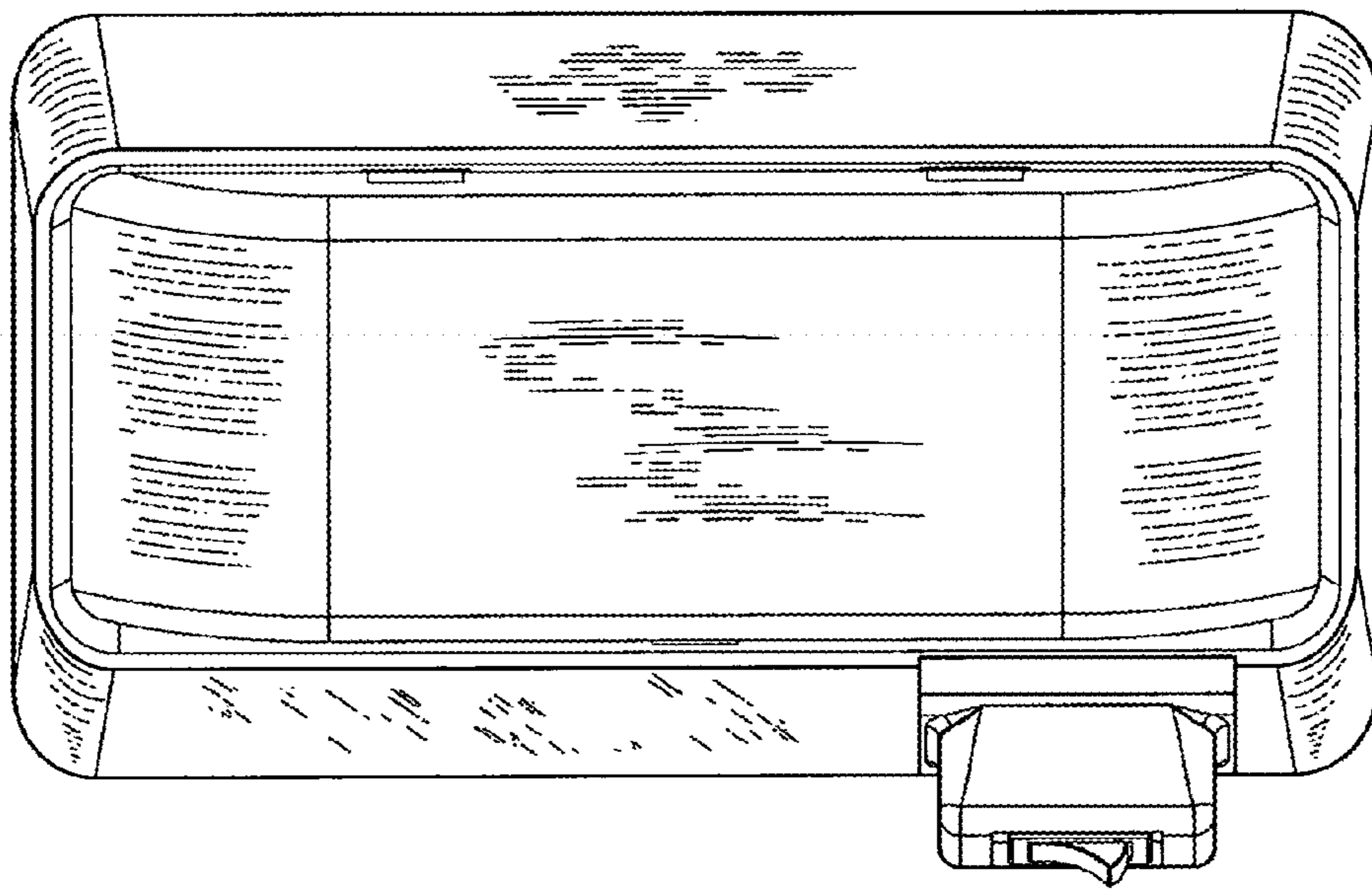

FIG. 2

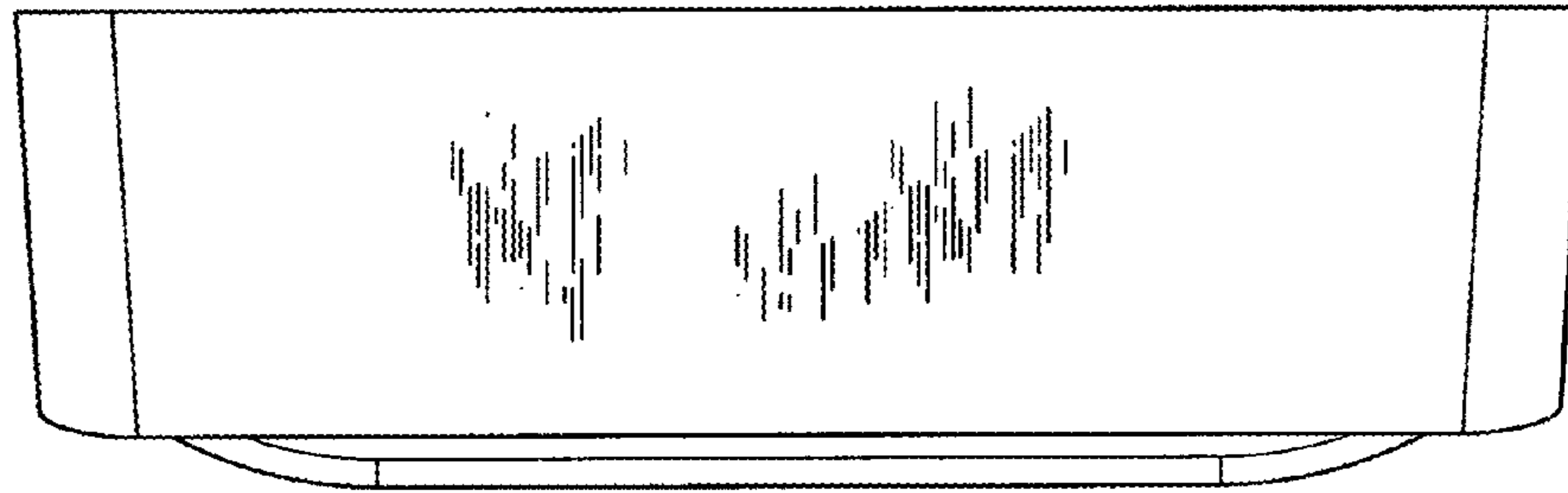

FIG. 3

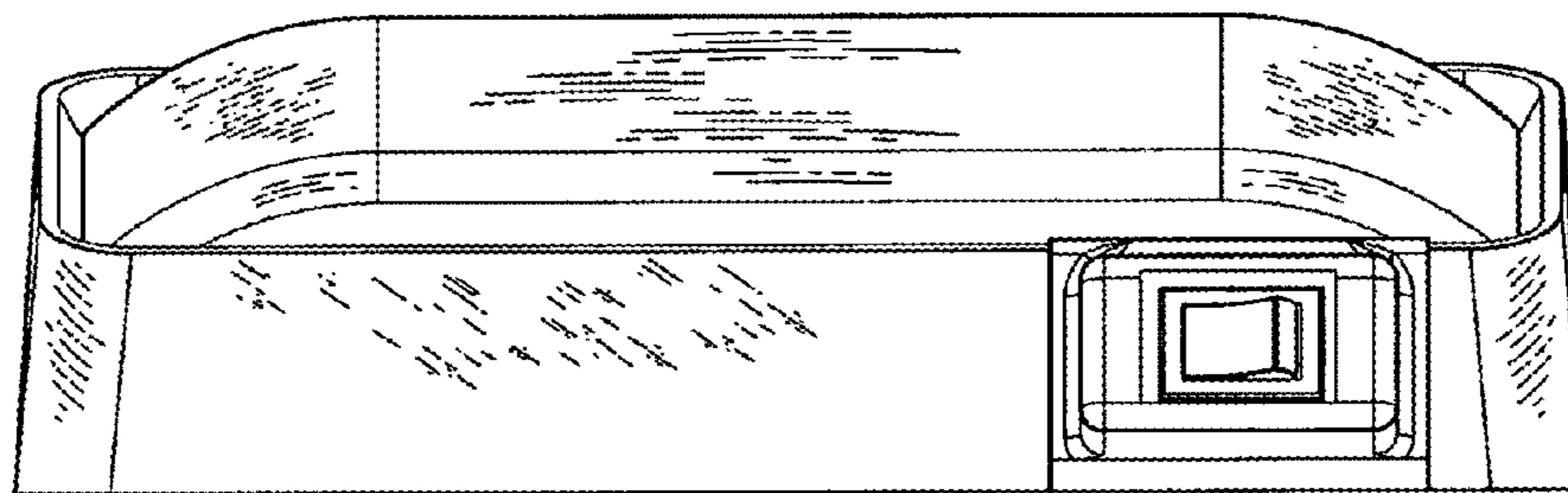

FIG. 4

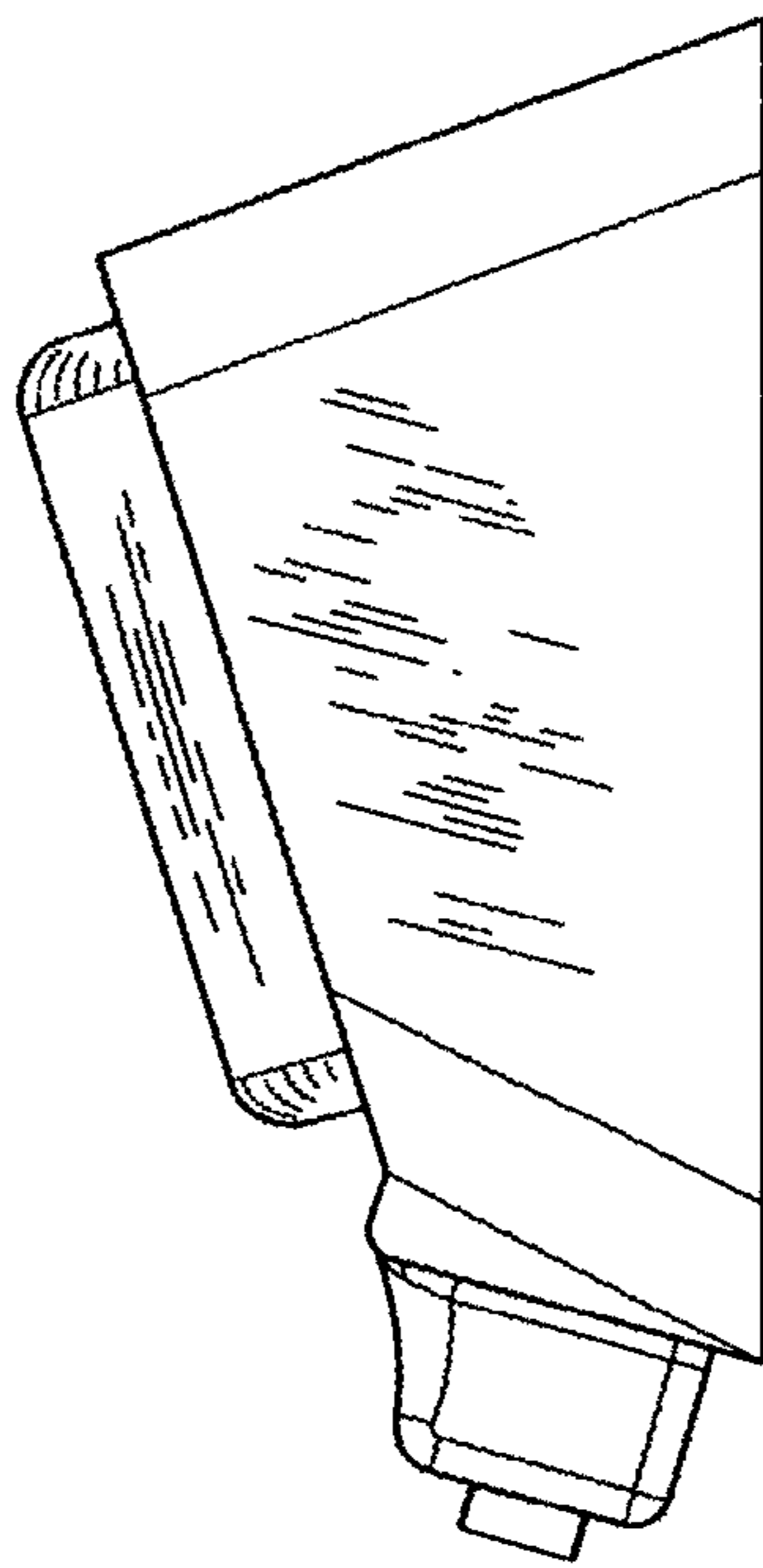

FIG. 5

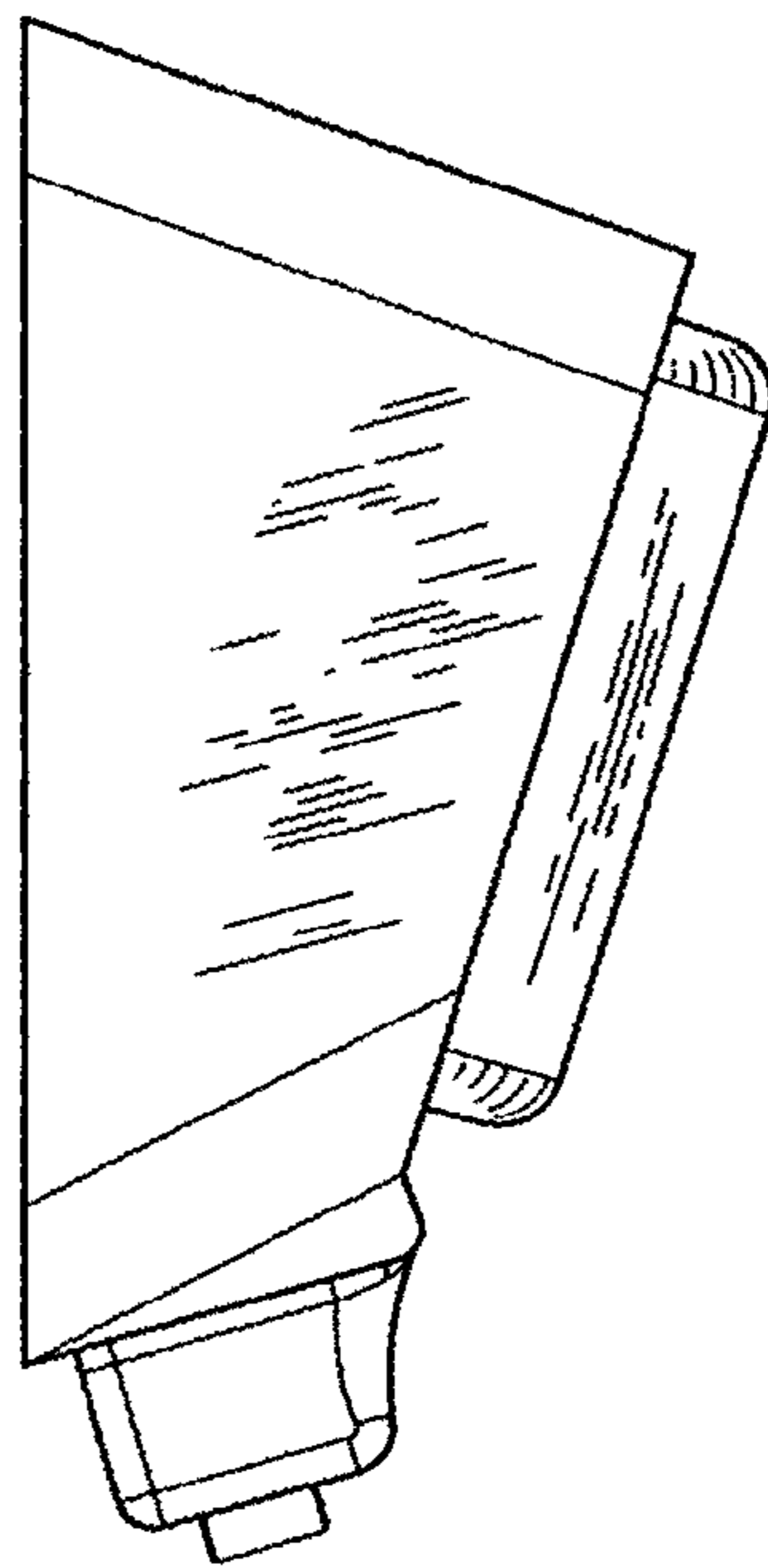

FIG. 6

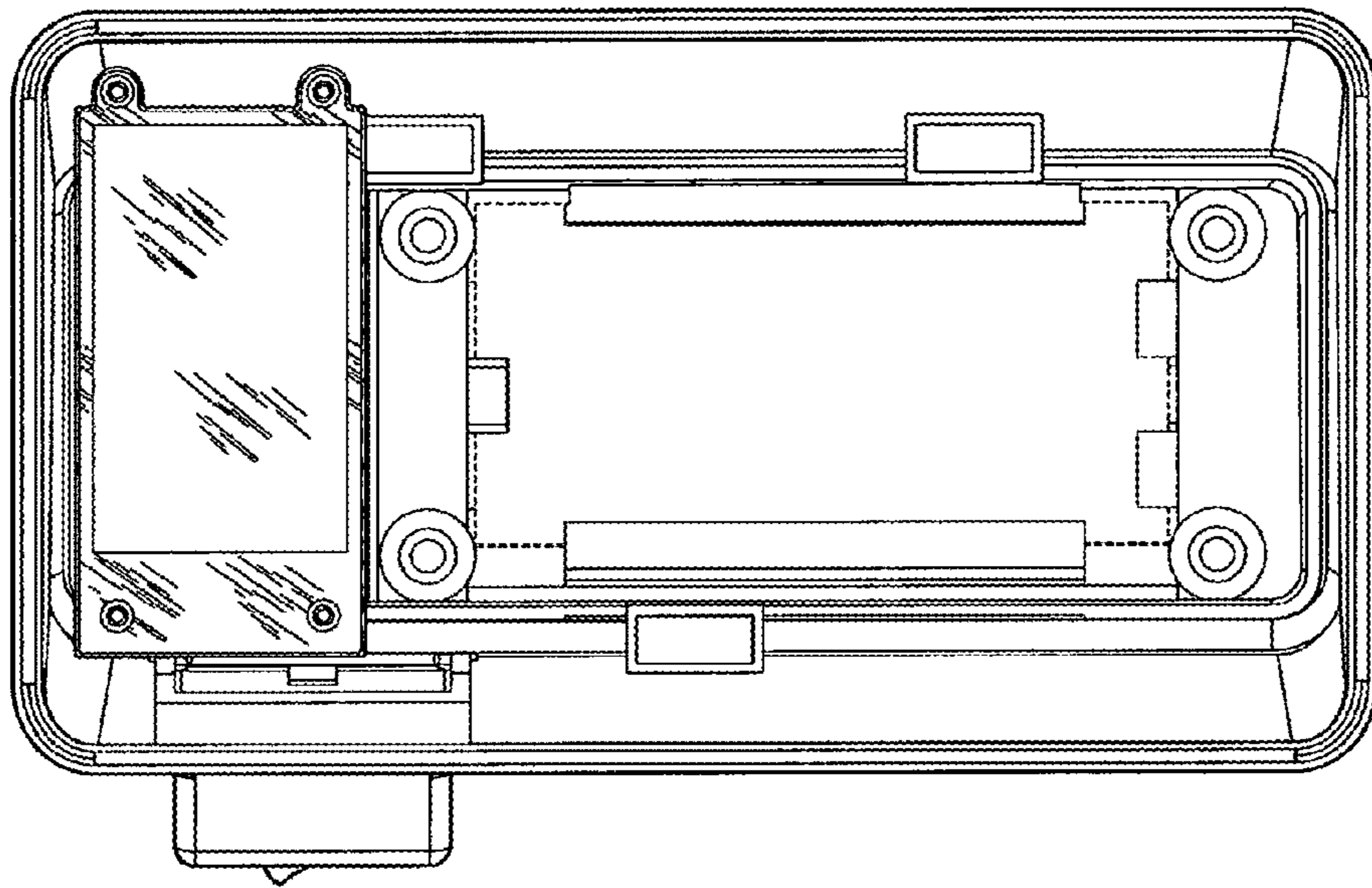

FIG. 7

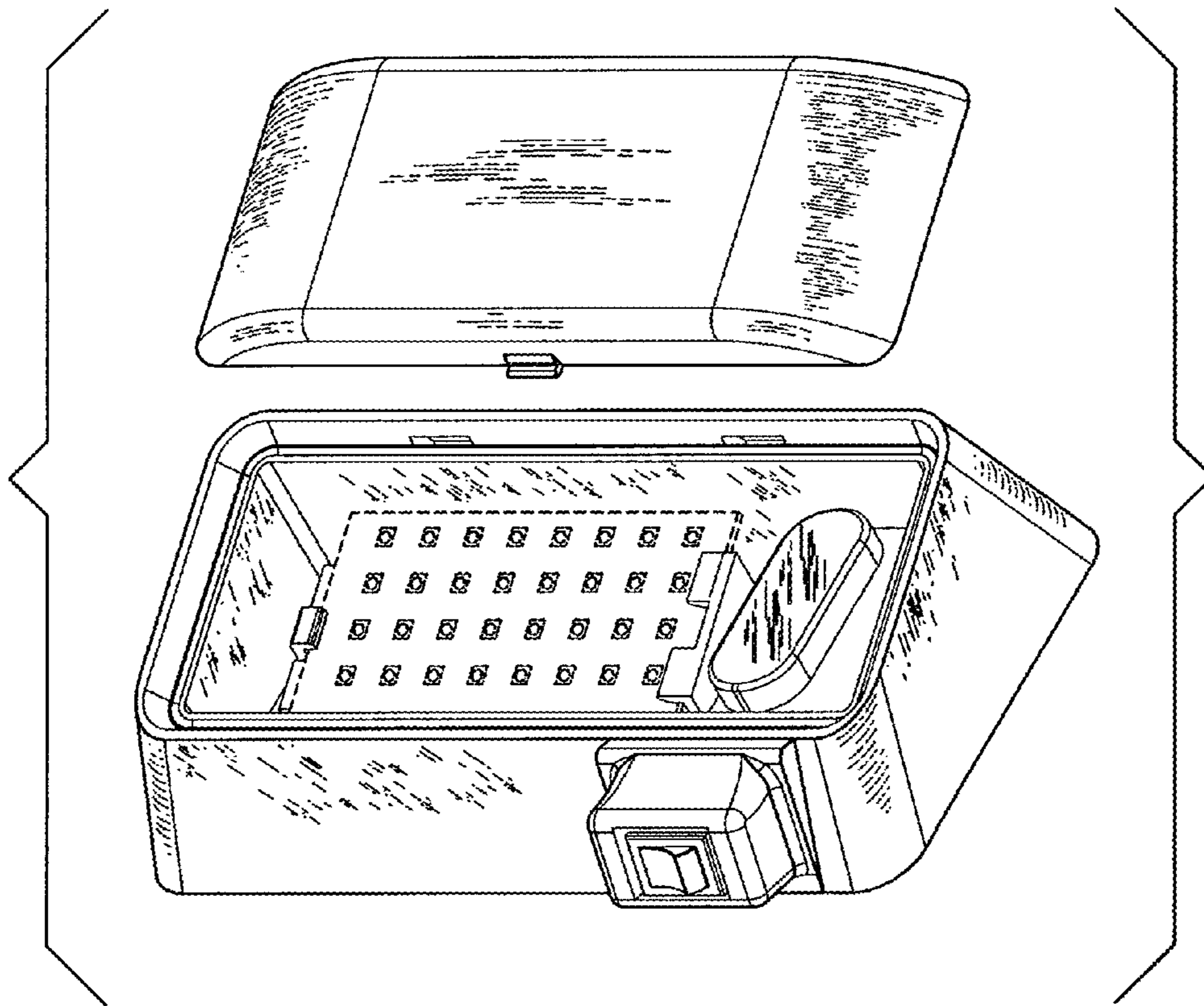

FIG. 8



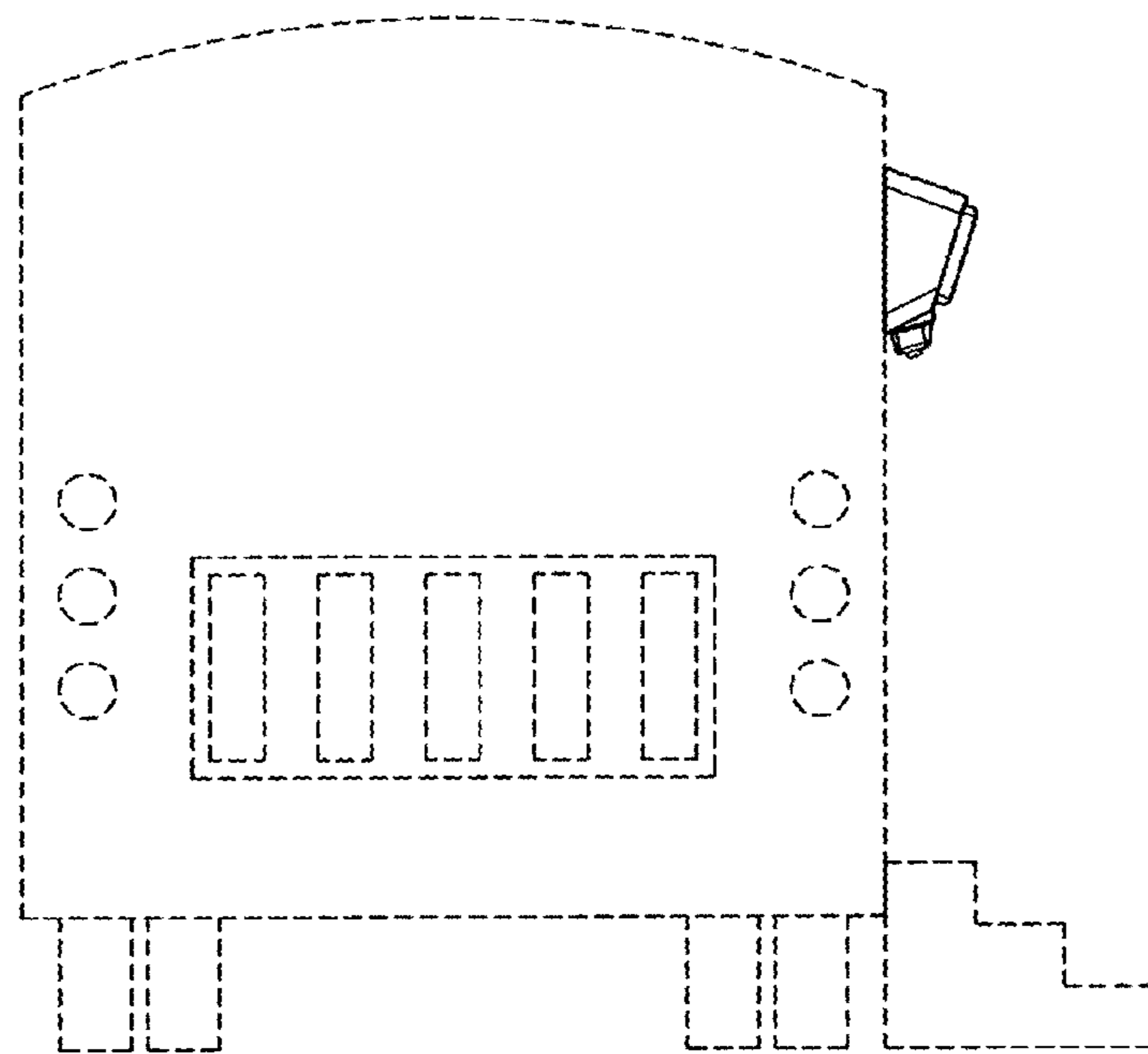

FIG. 9