



US00D755929S

(12) **United States Design Patent**
Kurisaki et al.

(10) **Patent No.:** **US D755,929 S**

(45) **Date of Patent:** **** May 10, 2016**

(54) **FLOW CONTROLLER**

(71) Applicants: **Shogo Kurisaki**, Tsukubamirai (JP);

Hideo Sasaki, Tsukubamirai (JP)

(72) Inventors: **Shogo Kurisaki**, Tsukubamirai (JP);

Hideo Sasaki, Tsukubamirai (JP)

(73) Assignee: **SMC Corporation**, Chiyoda-ku, Tokyo
(JP)

(**) Term: **14 Years**

(21) Appl. No.: **29/519,147**

(22) Filed: **Mar. 3, 2015**

(30) **Foreign Application Priority Data**

Sep. 12, 2014 (JP) 2014-020240

(51) **LOC (10) Cl.** **23-01**

(52) **U.S. Cl.**
USPC **D23/235**

(58) **Field of Classification Search**
USPC D23/233-250; 251/129.15, 129.19,
251/129.04, 129.01, 129.16, 129.17,
251/129.18; 137/15.18, 487.5, 625.45, 377,
137/498, 545, 547, 549
CPC . F16K 31/0675; F16K 27/029; F16K 27/048;
F16K 31/082

See application file for complete search history.

(56) **References Cited**

U.S. PATENT DOCUMENTS

D410,525	S	*	6/1999	Uehara	D23/235
D440,896	S	*	4/2001	Asai	D10/96
D601,225	S	*	9/2009	Kurisaki	D10/85
D602,795	S	*	10/2009	Oshima	D10/96
D641,070	S	*	7/2011	Fukano	D23/233
D665,287	S	*	8/2012	Fukano	D10/96
D701,131	S	*	3/2014	Kurisaki	D10/85
D720,044	S	*	12/2014	Enzaki	D23/233
2009/0260453	A1	*	10/2009	Kawakami	G01F 1/58 73/861.12

* cited by examiner

Primary Examiner — Cynthia Ramirez

Assistant Examiner — Gino Colan

(74) *Attorney, Agent, or Firm* — Yokoi & Co., U.S.A.;
Toshiyuki Yokoi

(57) **CLAIM**

The ornamental design for a flow controller, as shown and described.

DESCRIPTION

FIG. 1 shows a front view of a flow controller showing our new design;

FIG. 2 shows a rear view thereof;

FIG. 3 shows a right side view thereof;

FIG. 4 shows a left side view thereof;

FIG. 5 shows a top view thereof;

FIG. 6 shows a bottom view thereof; and,

FIG. 7 shows a top, front and left side perspective view thereof.

The portions of the design shown in broken lines in FIGS. 2 and 6 are for the purpose of illustrating the environment only and form no part of the claimed design.

1 Claim, 6 Drawing Sheets

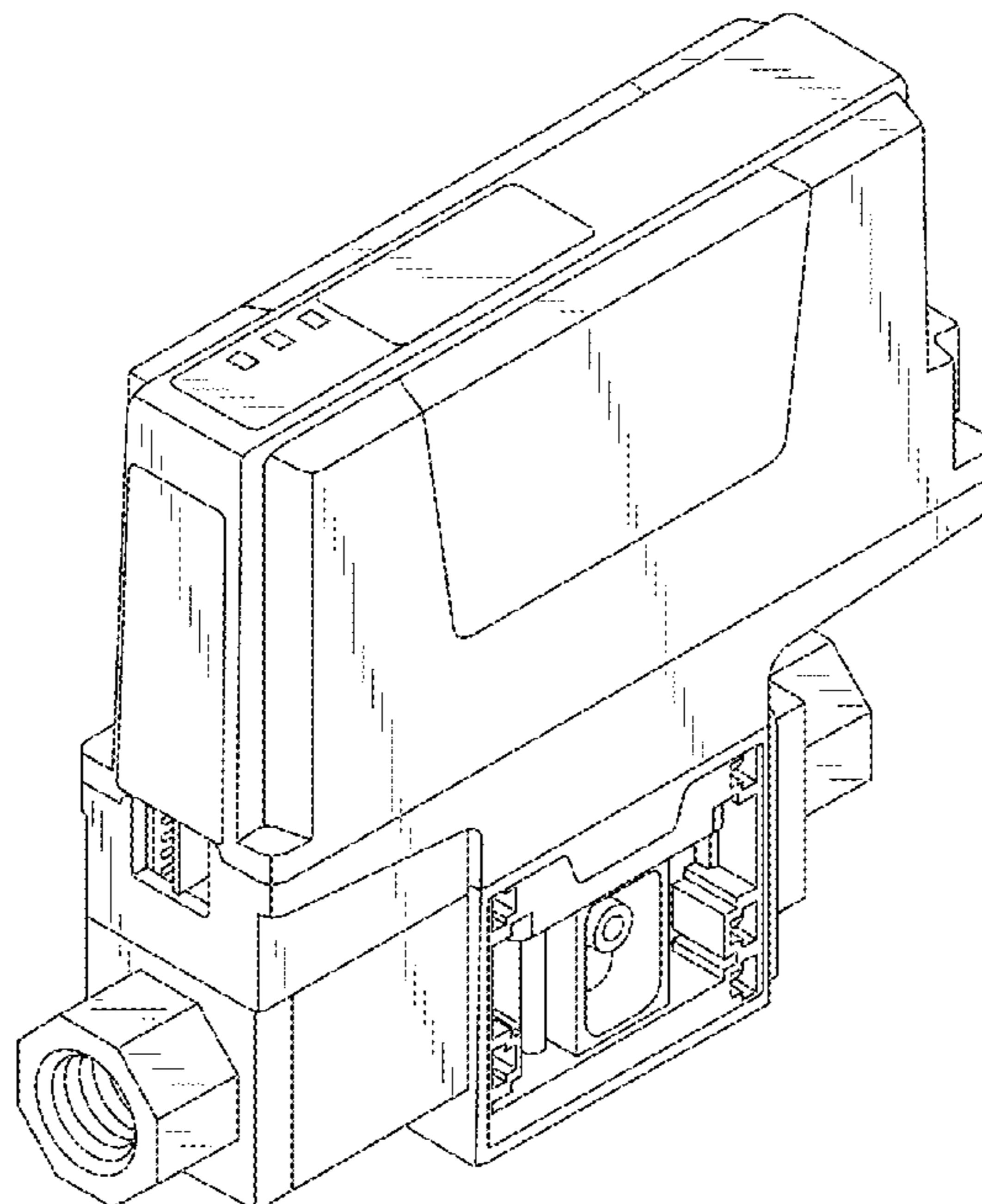

FIG. 1

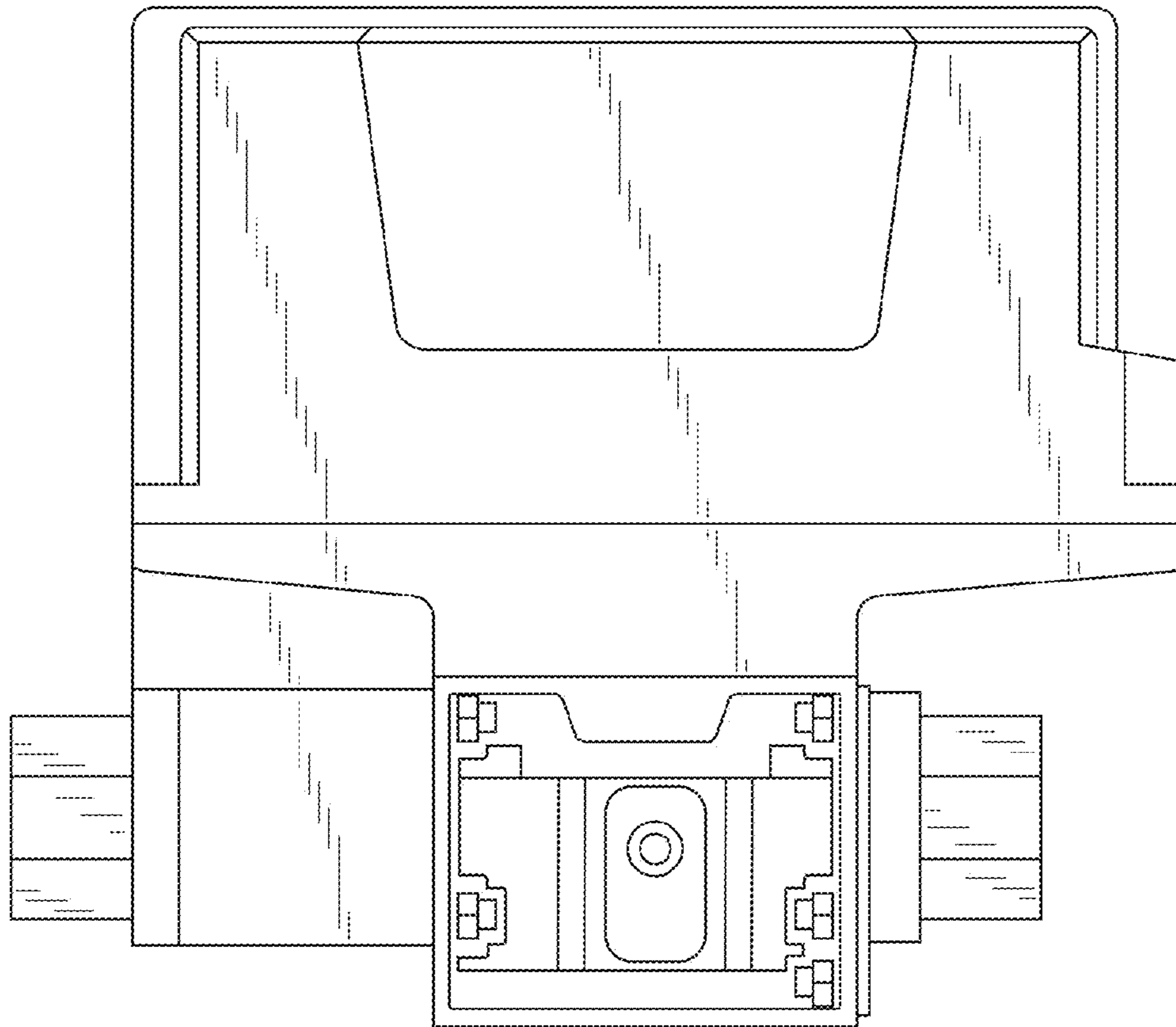

FIG. 2

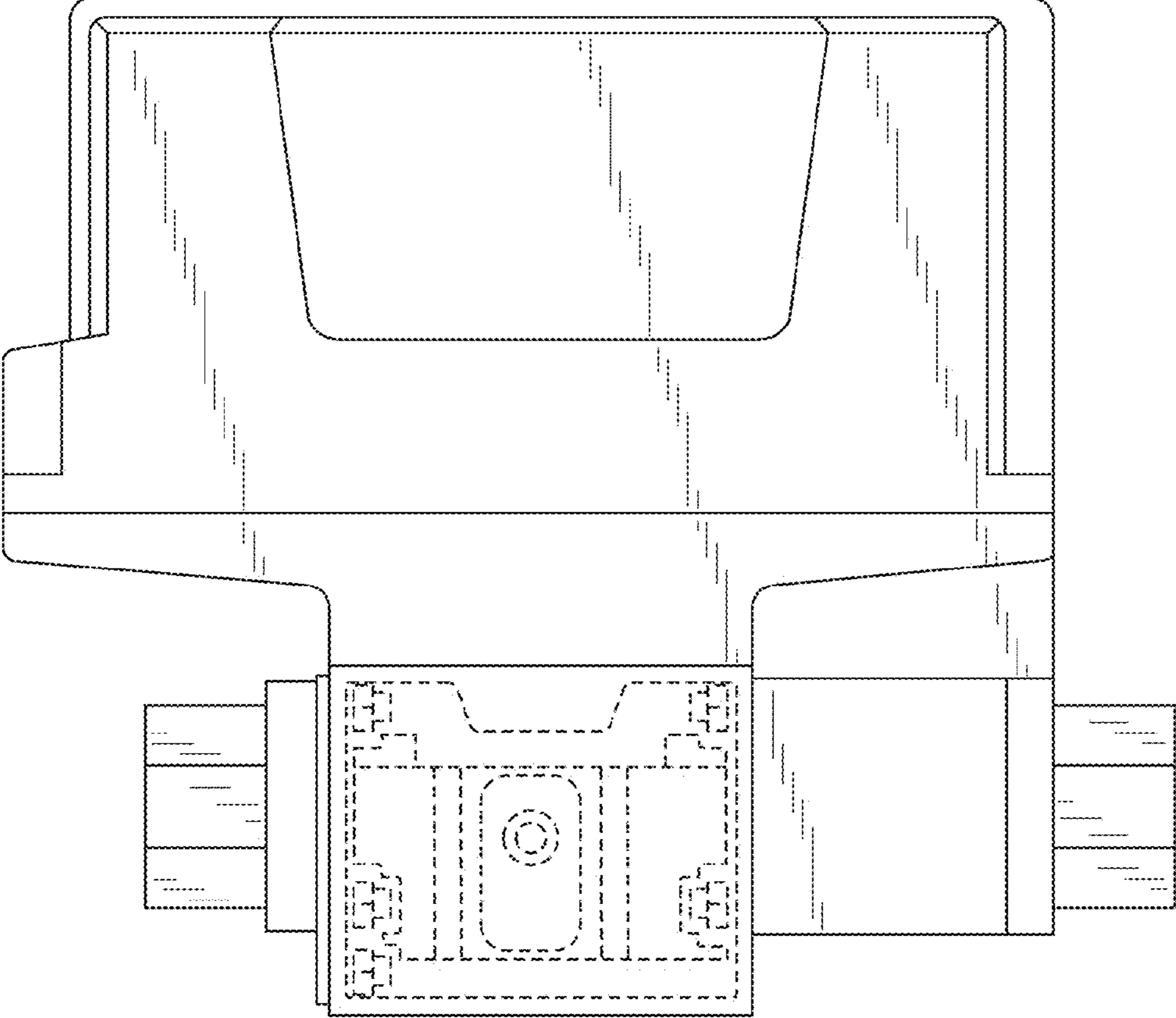

FIG. 3

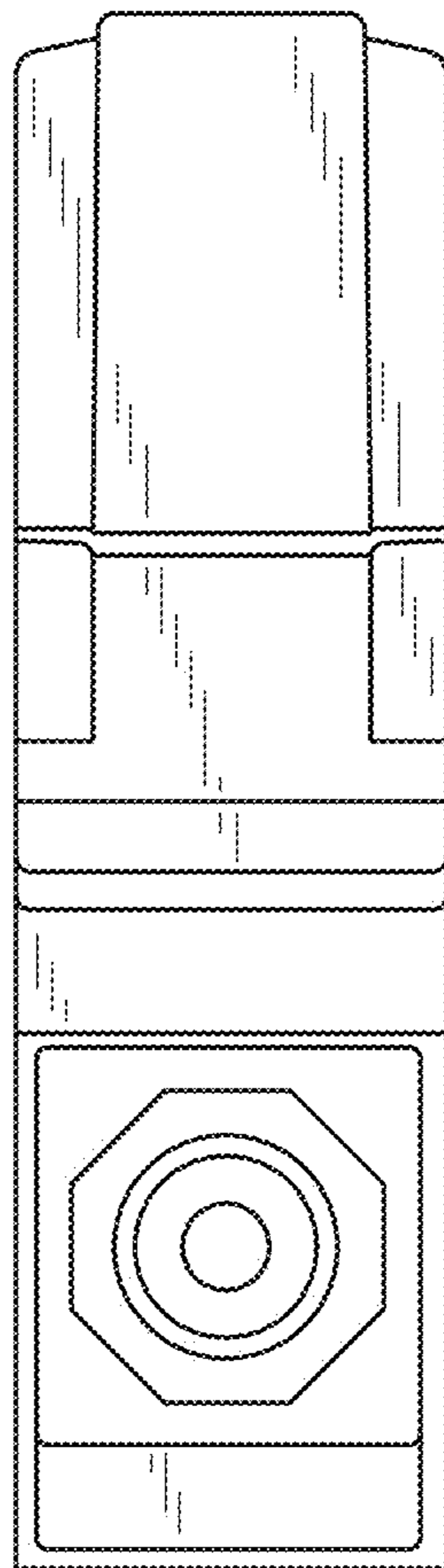

FIG. 4

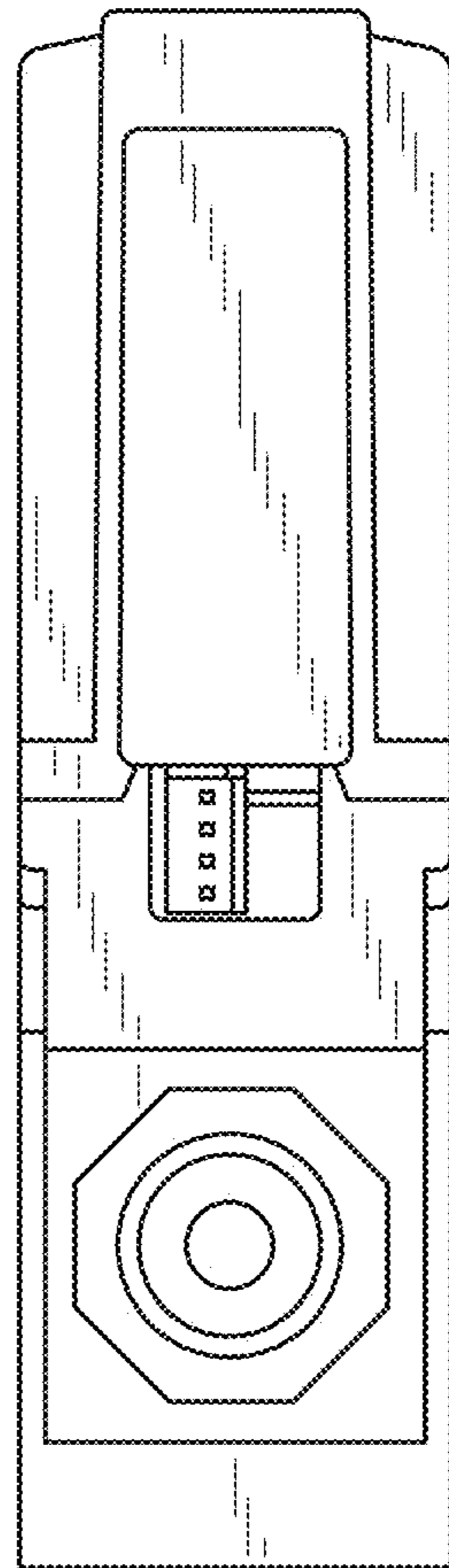

FIG. 5

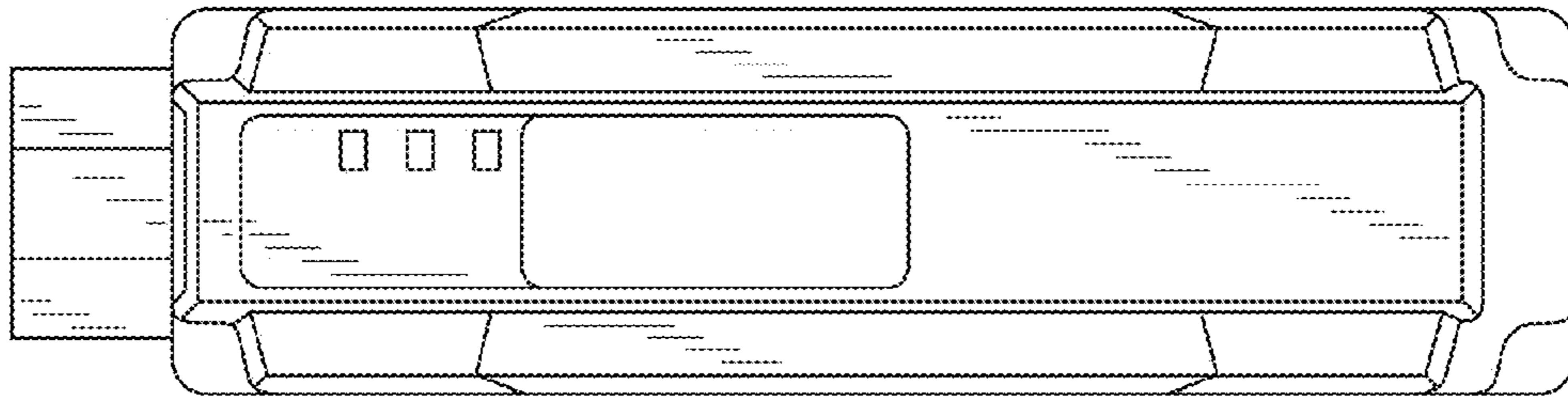

FIG. 6

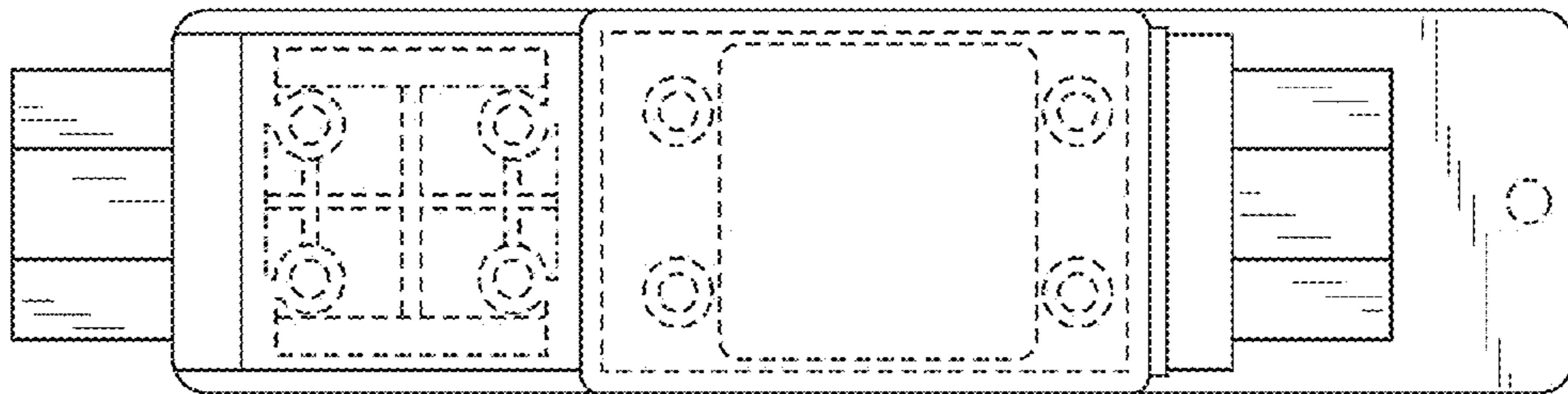

FIG. 7

