



US00D755912S

(12) **United States Design Patent**
McMahon, Jr.

(10) **Patent No.:** **US D755,912 S**

(45) **Date of Patent:** **** May 10, 2016**

(54) **PRACTICE HOCKEY GOALTENDER**

OTHER PUBLICATIONS

(71) Applicant: **James F. McMahon, Jr.**, Slingerlands,
NY (US)

James F. McMahon, Jr., pending U.S. Appl. No. 14/658,961, filed
Mar. 16, 2015, "Practice Hockey Goaltenders", 40-pages.

(Continued)

(72) Inventor: **James F. McMahon, Jr.**, Slingerlands,
NY (US)

Primary Examiner — Catherine Tuttle

(74) *Attorney, Agent, or Firm* — Heslin Rothenberg Farley
& Mesiti P.C.

(**) Term: **14 Years**

(57) **CLAIM**

The ornamental design for a practice hockey goaltender, as
shown and described.

(21) Appl. No.: **29/520,573**

DESCRIPTION

(22) Filed: **Mar. 16, 2015**

(51) **LOC (10) Cl.** **21-02**

(52) **U.S. Cl.**
USPC **D21/699**

(58) **Field of Classification Search**
USPC D21/698, 699, 705; D20/31
CPC A63B 69/00; A63B 69/0024; A63B
69/0026; A63B 69/34; A63B 63/00; A63B
63/06; A63B 63/004; A63B 2063/002; A63B
2102/24

See application file for complete search history.

A portion of the disclosure of this patent document contains
material which is subject to copyright protection. The copy-
right owner has no objection to the facsimile reproduction by
anyone of the patent document or the patent disclosure, as it
appears in the Patent and Trademark Office patent file or
records, but otherwise reserves all copyright rights whatso-
ever.

This application contains subject matter which is related to
the subject matter of commonly owned and co-filed U.S.
Utility patent application Ser. No. 14/658,961, entitled "Prac-
tice Hockey Goaltenders," by McMahon, Jr., which is hereby
incorporated herein by reference in its entirety.

A portion of the disclosure of this patent document contains
material which is a claim for copyright is made. The copyright
owner has no objection to the facsimile reproduction by any-
one of the patent document or the patent disclosure, as it
appears in the Patent and Trademark Office patent file or
records, but reserves all other copyright rights whatsoever.

FIG. 1 is a front perspective view of a practice hockey goal-
tender in accordance with the new design;

FIG. 2 is a rear perspective view of a thereof;

FIG. 3 is a front elevational view thereof;

FIG. 4 is a right side elevational view thereof;

FIG. 5 is a left side elevational view thereof;

FIG. 6 is a rear elevational view thereof;

FIG. 7 is a top view thereof; and,

FIG. 8 is a bottom view thereof.

The broken lines in the figures are included for the purpose of
illustrating portions of the practice hockey goal tender and its
environment that form no part of the claimed design.

(56) **References Cited**

U.S. PATENT DOCUMENTS

3,765,675	A *	10/1973	DiMarzio	A63B 63/06 273/126 A
4,489,940	A	12/1984	Amundson		
5,246,229	A *	9/1993	Carey	A63B 63/004 473/432
5,465,958	A *	11/1995	Brun	A63B 69/0079 473/426
5,498,000	A	3/1996	Cuneo		
D368,500	S *	4/1996	Parzino	D21/699
5,582,404	A	12/1996	Parzino		
5,647,747	A	7/1997	Macri et al.		
5,772,538	A	6/1998	Sztykiel et al.		
5,776,019	A	7/1998	Kronenberger		

(Continued)

1 Claim, 6 Drawing Sheets

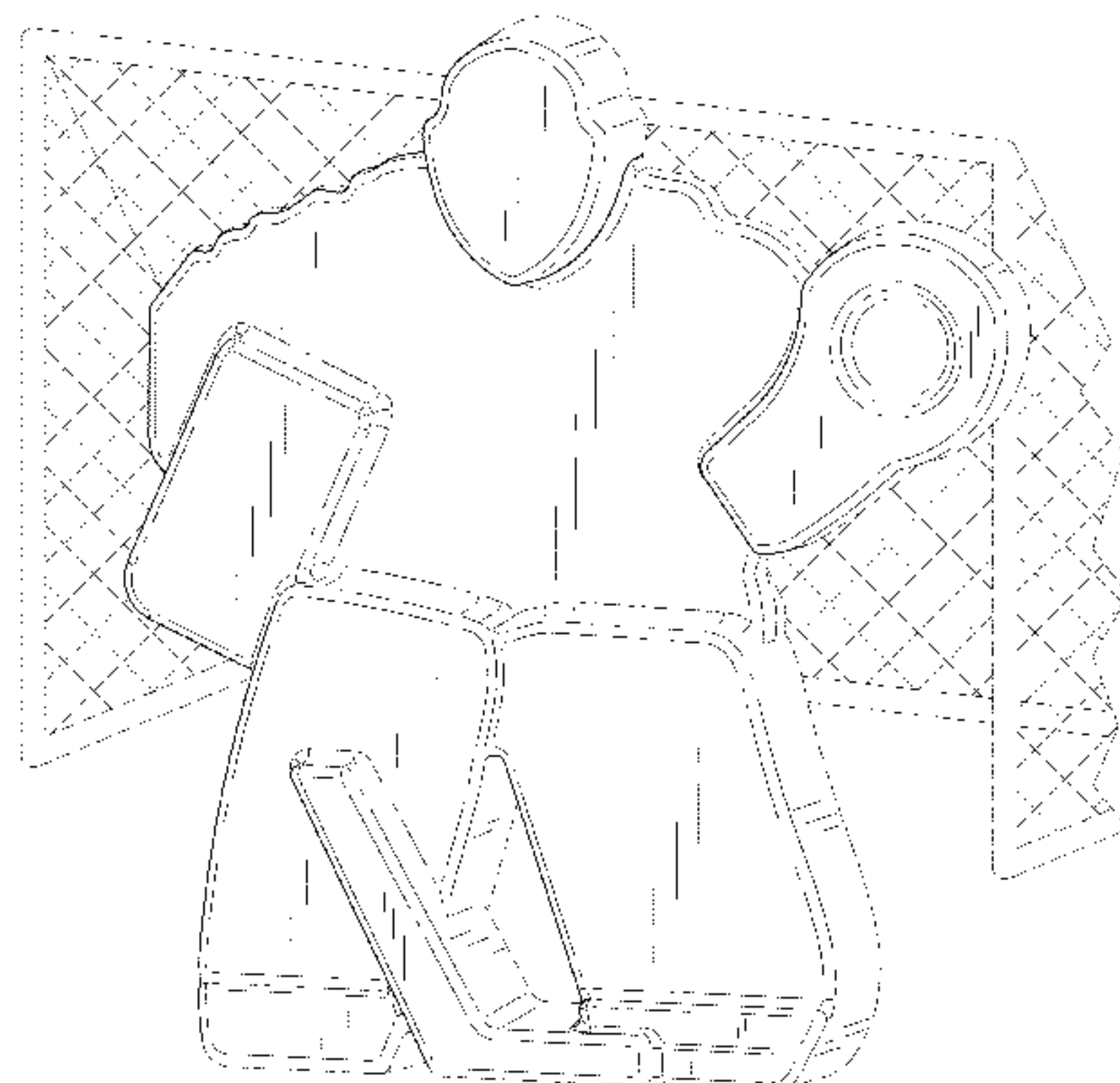

© Sureshot Hockey, LLC

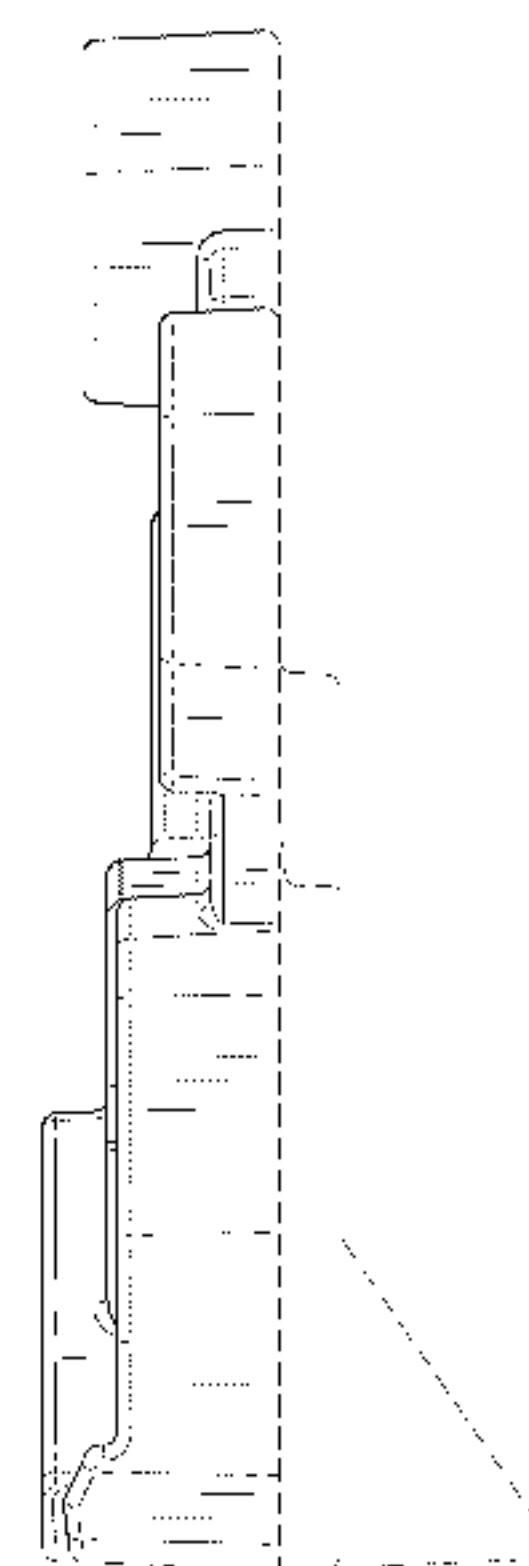

© Sureshot Hockey, LLC

(56)

References Cited

U.S. PATENT DOCUMENTS

D405,485	S *	2/1999	Mathison	D21/699
6,012,994	A	1/2000	Beluse	
D466,825	S	12/2002	Ettridge et al.	
6,595,878	B1 *	7/2003	Nelson	A63B 69/002 273/407
D495,385	S *	8/2004	Winger	D21/699
6,796,914	B2 *	9/2004	Berdugo	A63B 69/002 273/359
6,796,915	B2	9/2004	Getchell	
6,926,624	B1 *	8/2005	Witzke	A63B 63/00 446/118
7,156,760	B2	1/2007	Berdugo et al.	
7,651,416	B2 *	1/2010	Farquhar	A63B 63/004 273/398
8,128,518	B1 *	3/2012	Kudla	A63B 69/0026 473/478
2006/0019775	A1	1/2006	Nurthen	
2015/0190693	A1 *	7/2015	Gilman	A63B 63/06 473/446

OTHER PUBLICATIONS

Mylec 3D Mini Goalie Hockey Buddy, available from Amazon.com, printout available online on Mar. 4, 2015, at http://www.amazon.com/Mylec-Mini-Goalie-Hockey-Buddy/dp/B000LGZVSE/ref=sr_1_9?ie=UTF8&qid=1393594204&sr=8-9&keywords=hockey+goalie+training, 6-pages, at least as early as Dec. 25, 2010.

Ultimate Goalie, available from Sniper's Edge Hockey, printout available online on Mar. 4, 2015, at <http://www.snipersedgehockey.com/products/ultimate-goalie-hockey-single>, 4-pages, at least as early as Dec. 23, 2014.

Shooting Packages, available from Sniper's Edge Hockey, printout available online on Mar. 4, 2015, at <http://www.snipersedgehockey.com/collections/hockey-shooting-packages>, 4-pages, at least as early as Dec. 23, 2014.

Stickhandling Pucks, available from Sniper's Edge Hockey, printout available online on Mar. 4, 2015, at <http://www.snipersedgehockey.com/collections/balls-pucks>, 4-pages, at least as early as Dec. 23, 2014.

Blazer Replacement Track Spikes, available at <http://www.eastbay.com>, printout available online on Mar. 4, 2015, at http://www.eastbay.com/Cross-Country/_-_/N-1hi/keyword-replacement+track+spikes?brand=Blazer&cm_

REF=Cross+Country, 4-pages, at least as early as Jul. 7, 2008.

Sof Sole Steel Pyramid Track Cleats, available from Amazon.com, printout available online on Mar. 4, 2015, at http://www.amazon.com/gp/product/B005FIX5RW/ref=pd_lpo_sbs_dp_l_ss_2?pf_rd_p=1944687562&pf_rd_s=lpo-top-stripe-1&pf_rd_t=201&pf_rd_i=B008B51OCO&pf_rd_m=ATVPDKIKX0DER&pf_rd_r=1YA1XF91GHN4WVE9ZS3P, 3-pages, at least as early as May 3, 2012.

Rick O Shay Goal Blocker, available from HockeyShot.com, printout available online on Apr. 10, 2015, at <http://www.hockeyshot.com/Rick-O-Shay-Goal-Blocker-p/target-tarp-013.htm>, 7-pages, at least as early as Sep. 2, 2012.

* cited by examiner

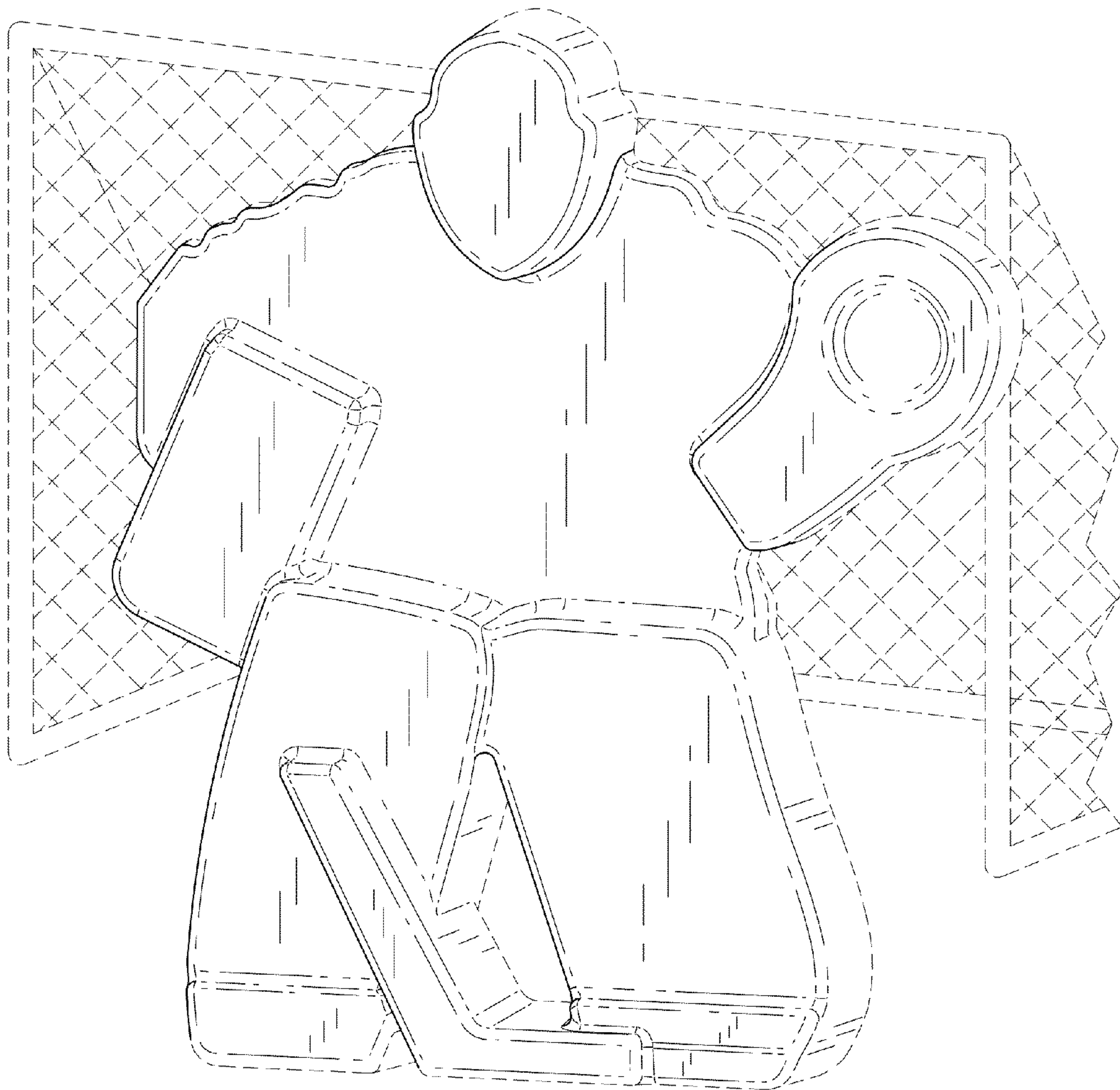

© Sureshot Hockey, LLC

FIG. 1

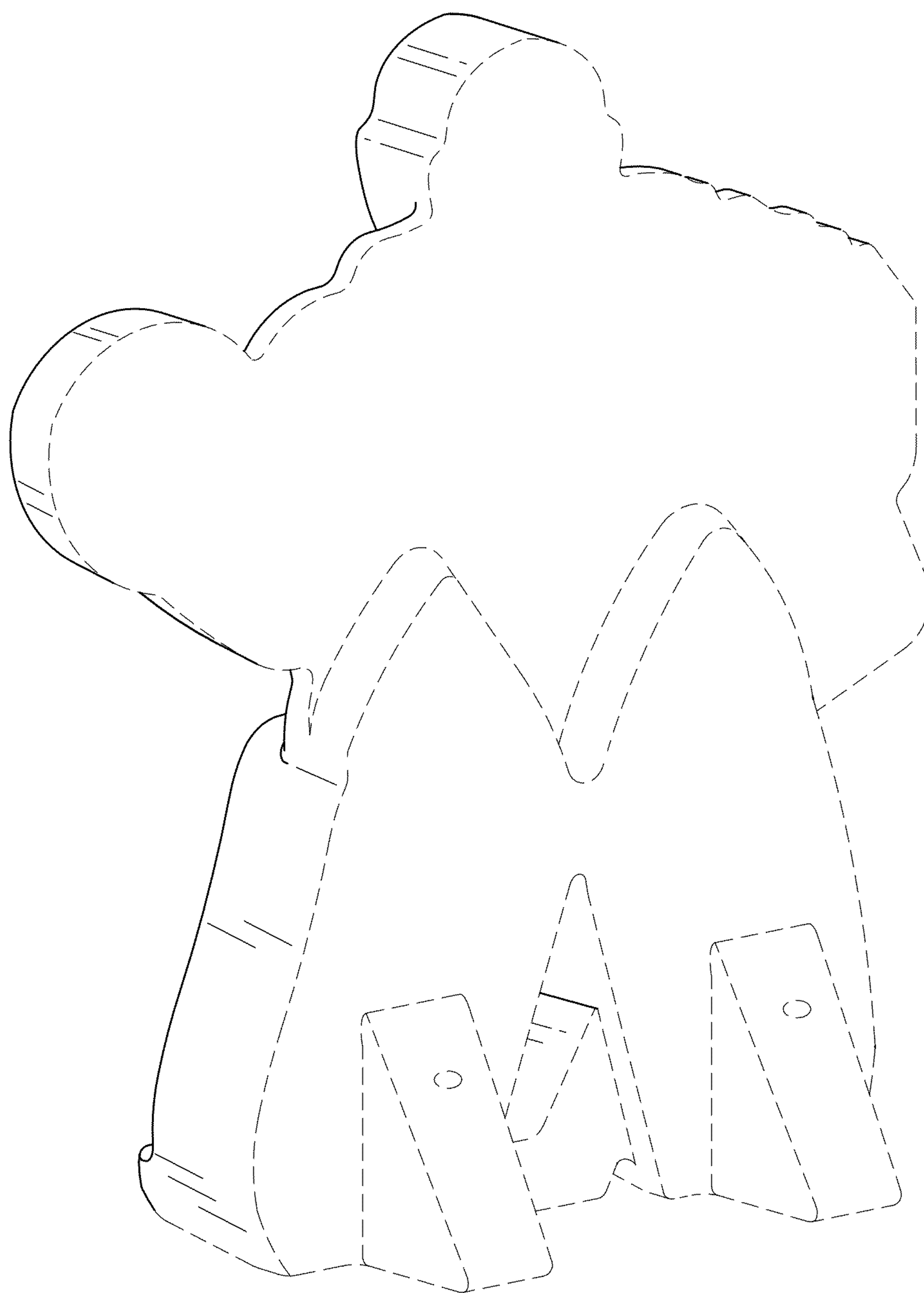

© Sureshot Hockey, LLC

FIG. 2

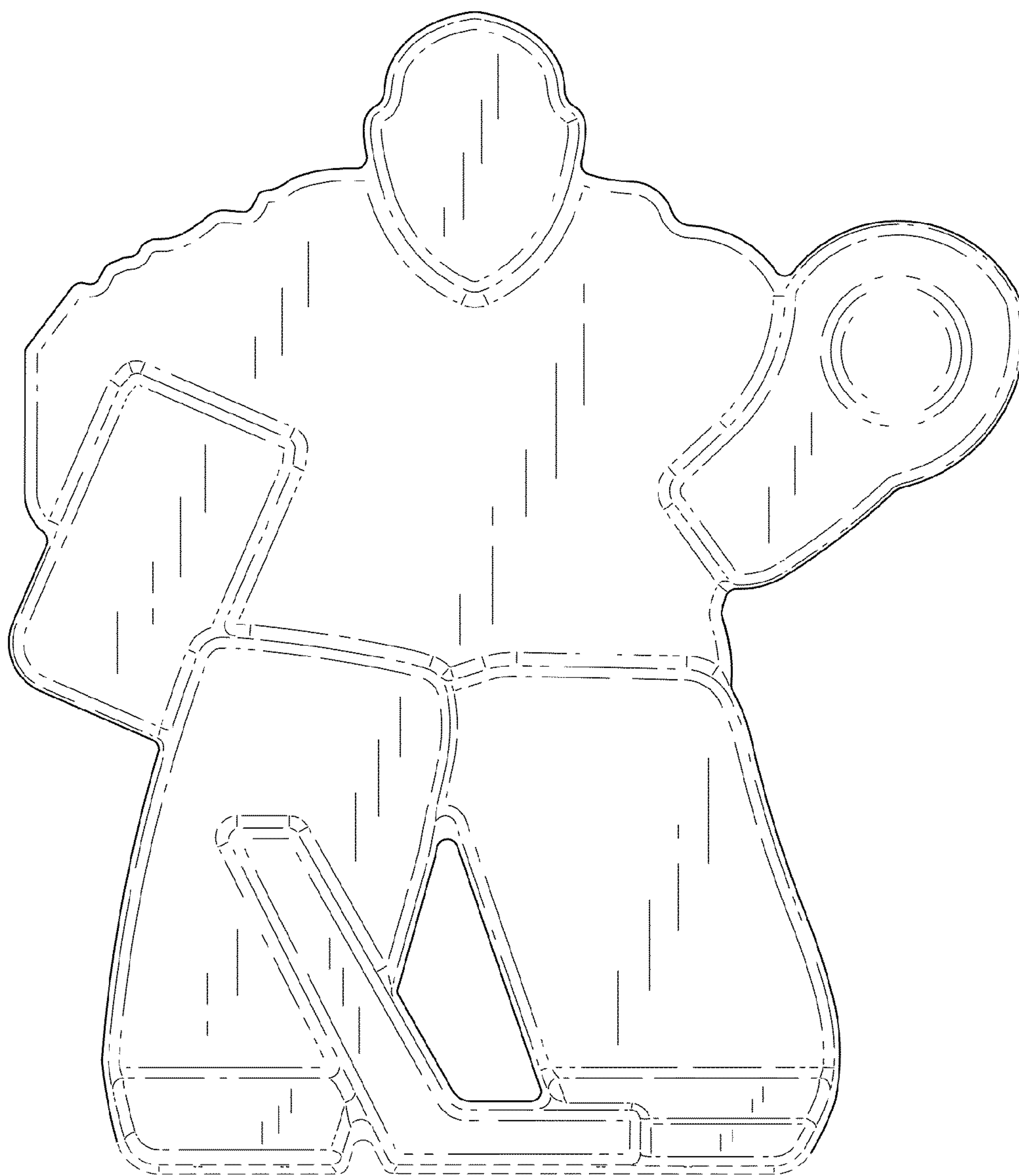

© Sureshot Hockey, LLC

FIG. 3

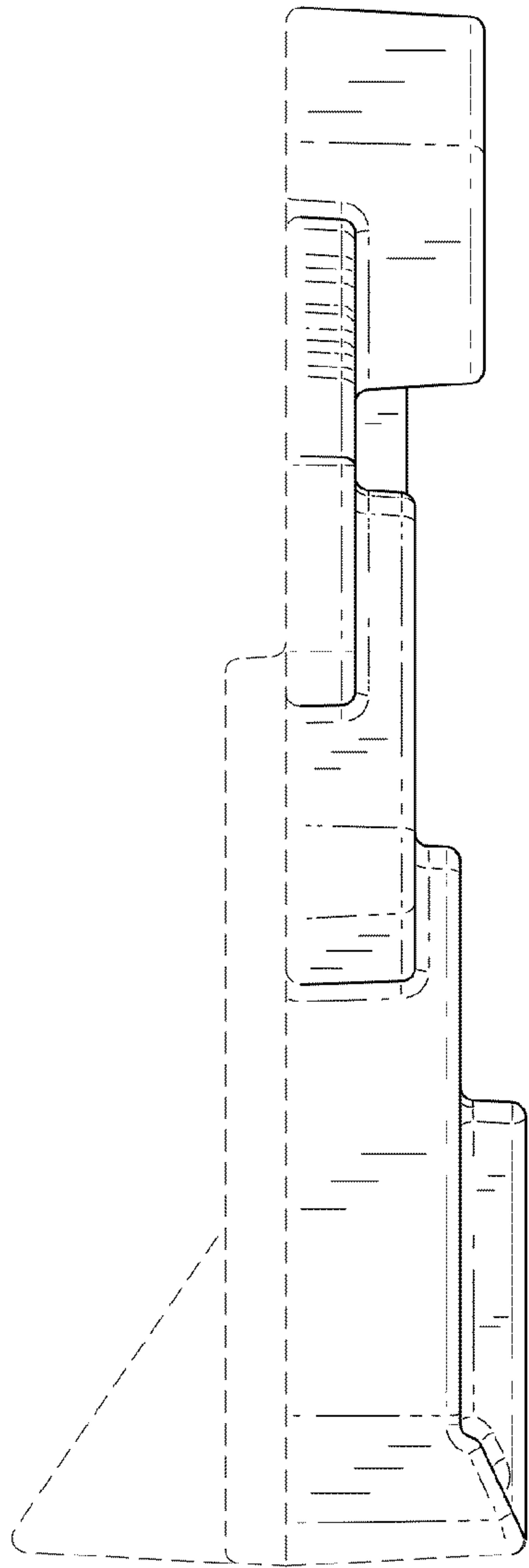

© Sureshot Hockey, LLC

FIG. 4

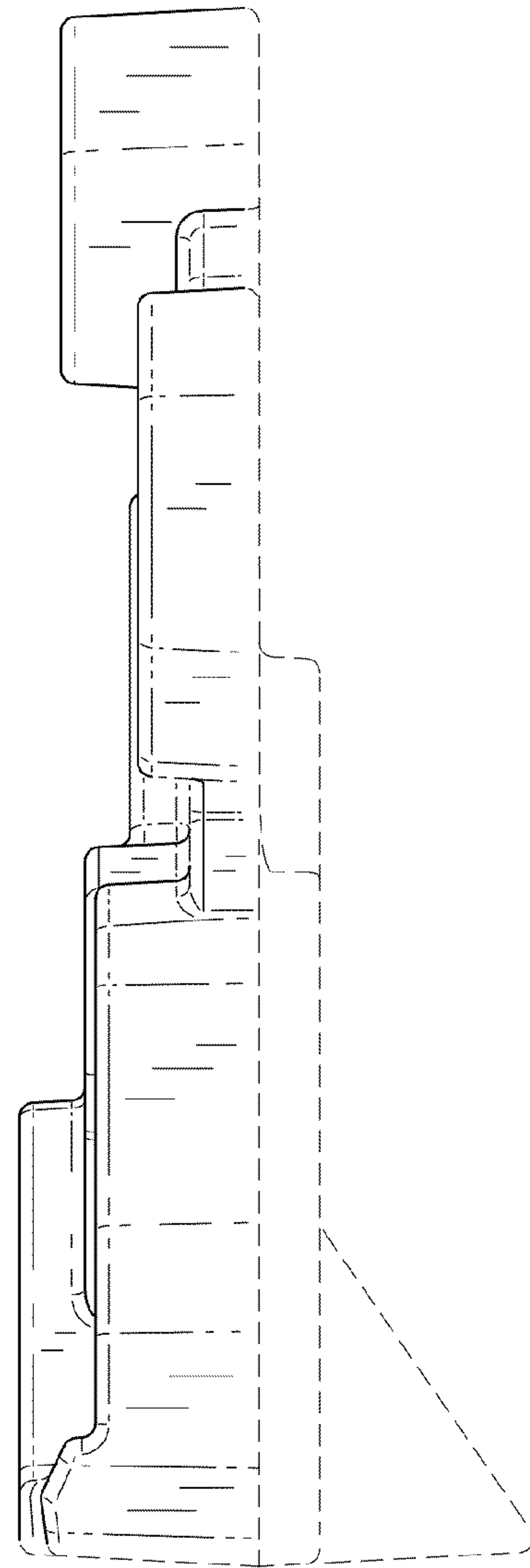

© Sureshot Hockey, LLC

FIG. 5

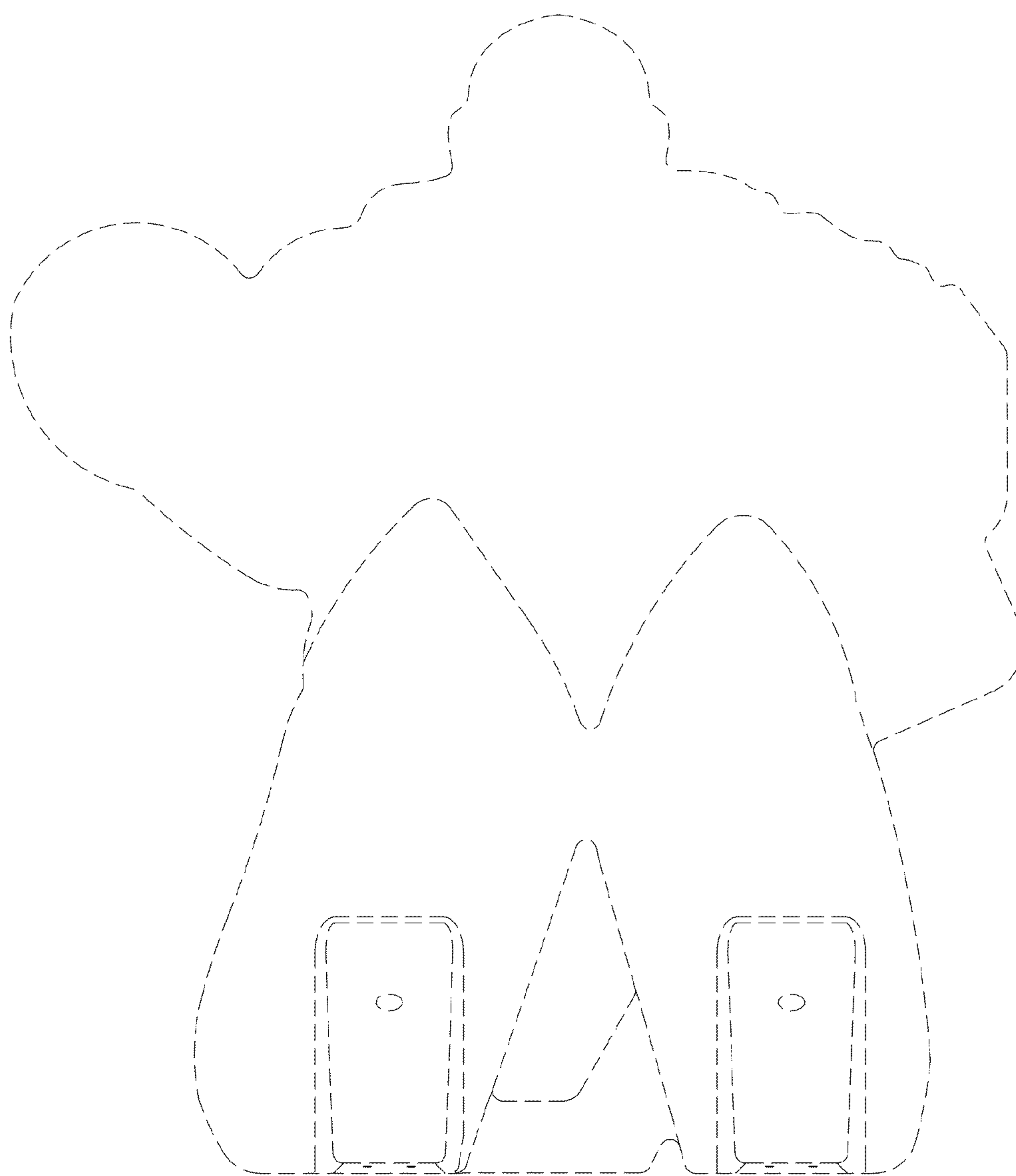

© Sureshot Hockey, LLC

FIG. 6

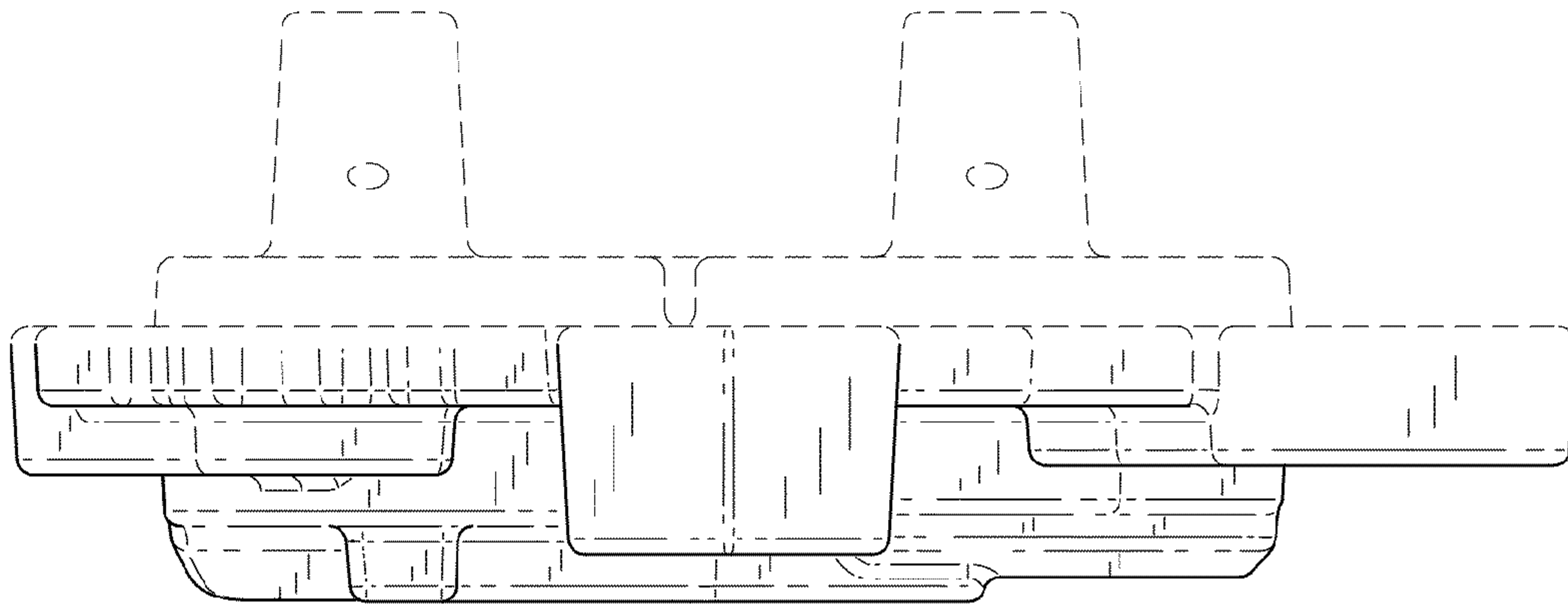

© Sureshot Hockey, LLC

FIG. 7

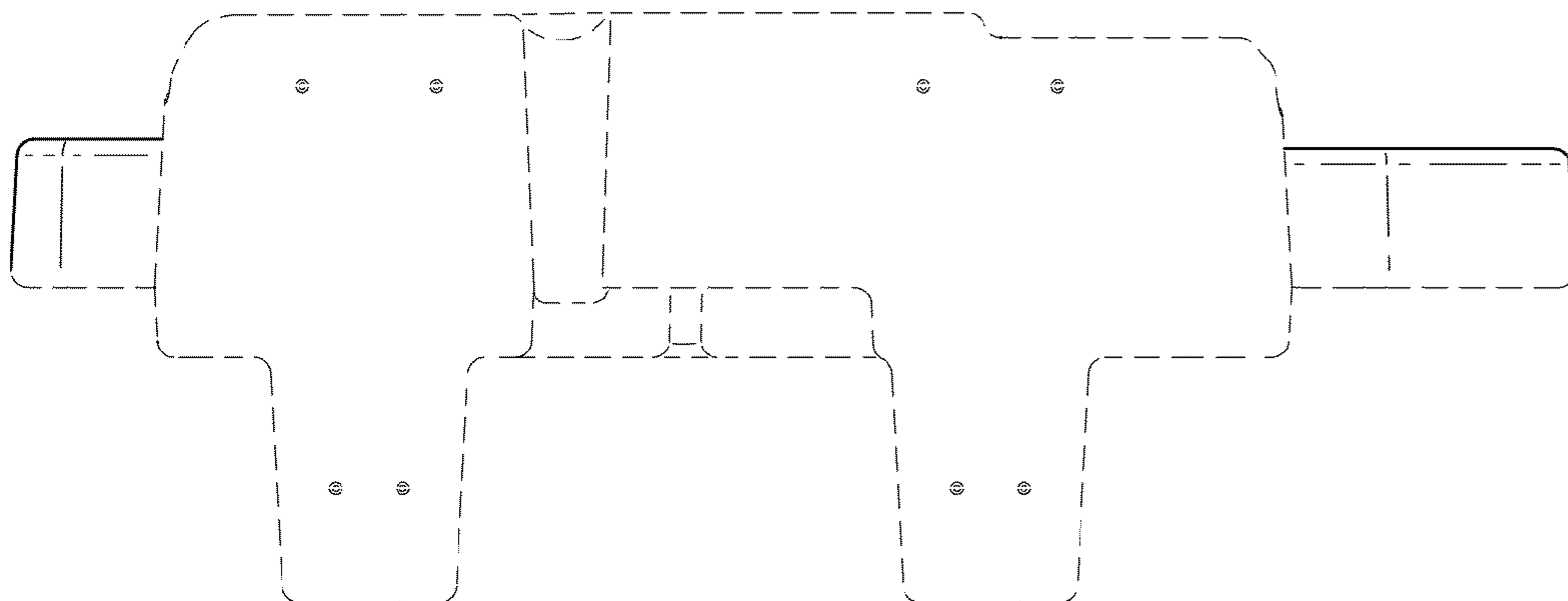

© Sureshot Hockey, LLC

FIG. 8